

Surface Mount 719.0MHz SAW Filter

AFS20A05-719.00-T2

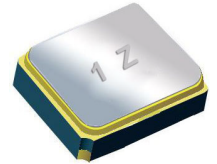

RoHS
Compliant



2.0 x 1.6 x 0.9 mm

FEATURES:

- 2.0 * 1.6 * 0.9 mm low profile SMT package
- Low Insertion loss
- Excellent selectivity with high out-of-band rejection

APPLICATIONS:

- Wireless Communication
- Remote Control
- Cellular Phones

ELECTRICAL SPECIFICATIONS:

Maximum Ratings

Item	Value
Input Power Level	+10 dBm max.
DC Permissive Voltage	3V DC max.
Operating Temperature Range	-30°C to + 85°C
Storage Temperature Range	-40°C to + 85°C

Parameters	Minimum	Typical	Maximum	Units	Notes
Center Frequency (f_c)		719		MHz	
Insertion Loss (IL)		2.70	3.20	dB	716.5 ~ 721.5MHz
3-dB Bandwidth		5.00		MHz	
Amplitude Ripple		0.70	2.20	dB	716.5 ~ 721.5MHz
Group Delay Variation		42	95	ns	716.5 ~ 721.5MHz
Worst-Case Input / Output Return Loss		5	8	dB	716.5 ~ 721.5MHz
Stop-band Attenuation (Referenced to 0.0 dB)	40	54		dB	DC ~ 690MHz
	35	47			690 ~ 704MHz
	30	48			704 ~ 710MHz
	25	29			728 ~ 734MHz
	27	33			734 ~ 750MHz
	37	53			750 ~ 824MHz
	45	54			824 ~ 960MHz
	32	39			960 ~ 2500MHz
Source Impedance (Z_s)		50		Ω	See note # 1
Load Impedance (Z_L)		50		Ω	See note # 1

Note #1:

No matching network required for operation into 50 Ω 's

TEST CIRCUIT:

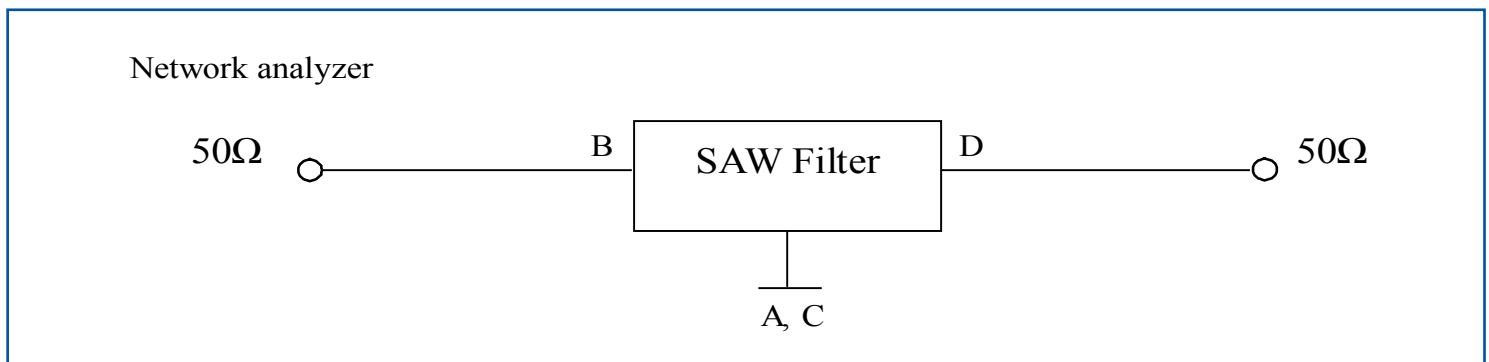

Surface Mount 719.0MHz SAW Filter

AFS20A05-719.00-T2

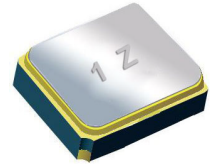

2.0 x 1.6 x 0.9 mm

OUTLINE DIMENSIONS:

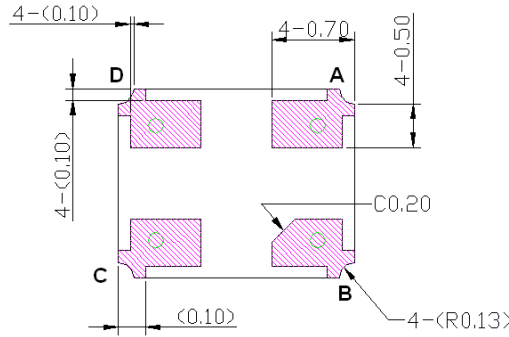
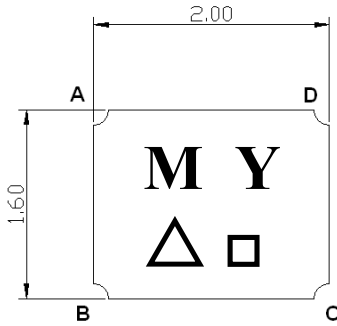

Recommended Land Pattern:

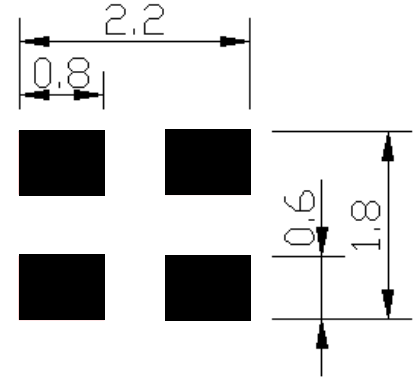

#B:	Input
#D:	Output
#A,C:	Ground
Unit:	mm

- △ = Year (1=2011, for example)
- = Week (A through Z → Week-01~ Week-26)
(a through z → Week-27~ Week-52)

*All Dimensions are in mm

FREQUENCY CHARACTERISTICS:

Filter Frequency Response (Narrowband)

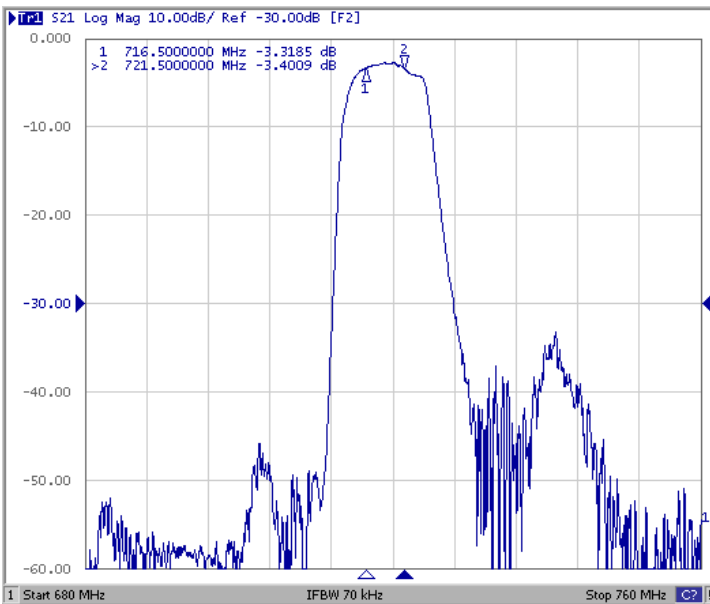

Filter Frequency Response (Wideband)

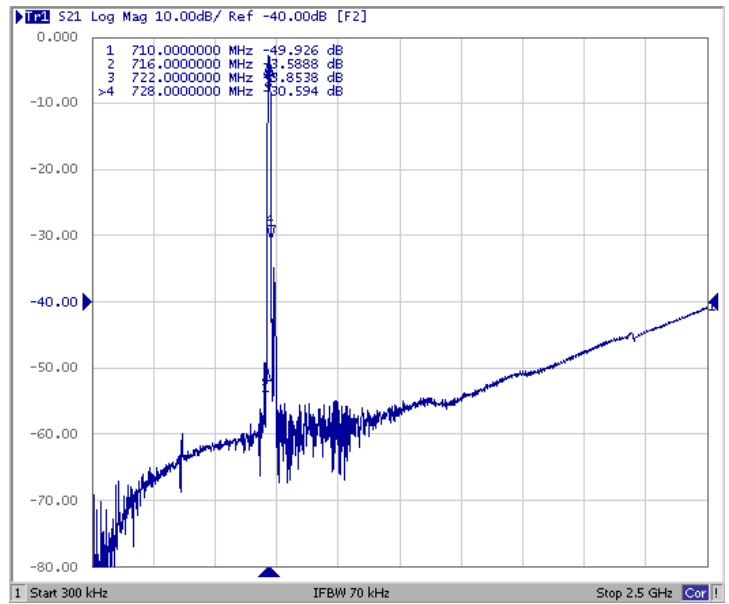

Surface Mount 719.0MHz SAW Filter

AFS20A05-719.00-T2



RoHS
Compliant

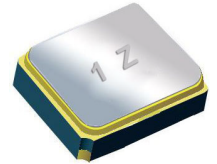

2.0 x 1.6 x 0.9 mm

FREQUENCY CHARACTERISTIC:

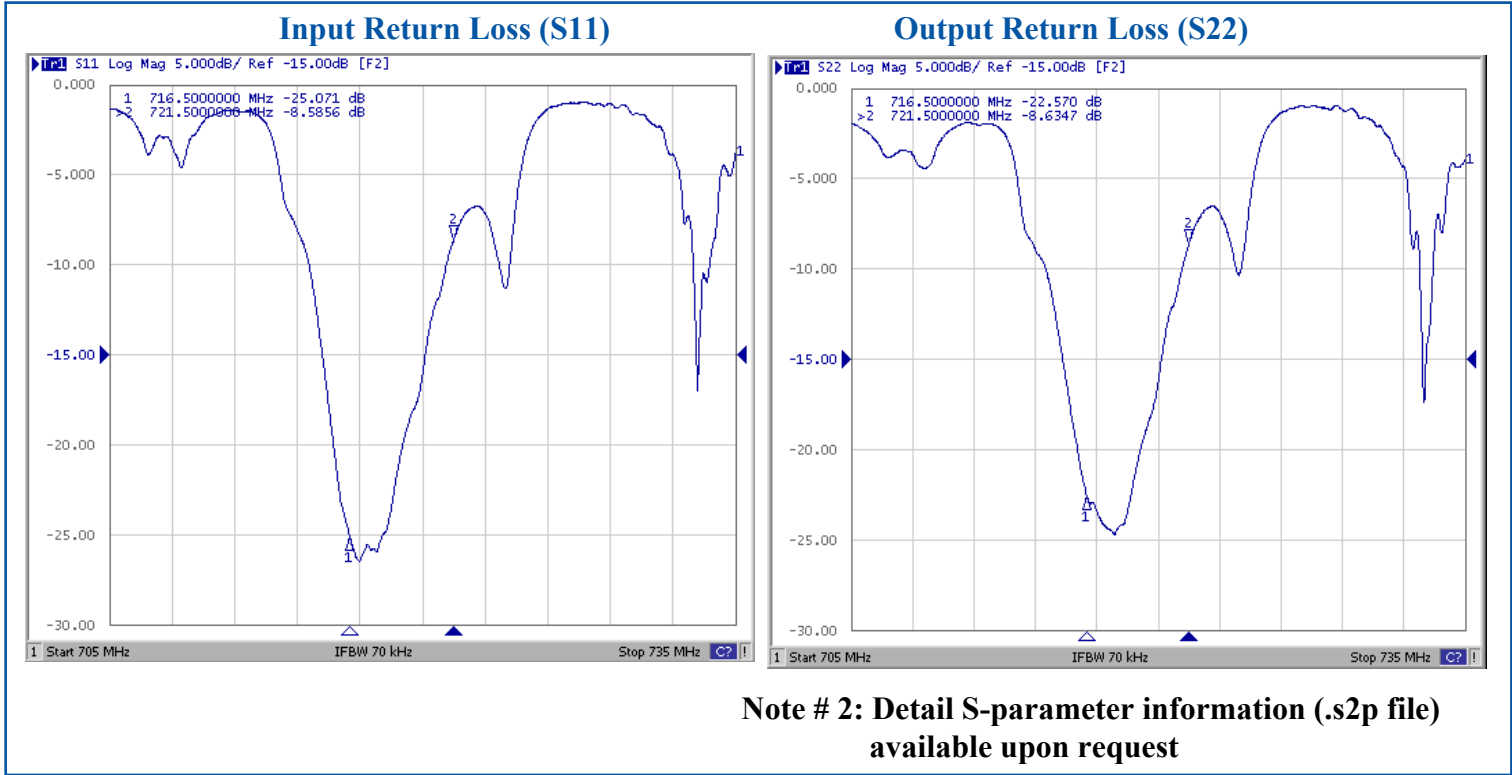

REFLOW PROFILE:

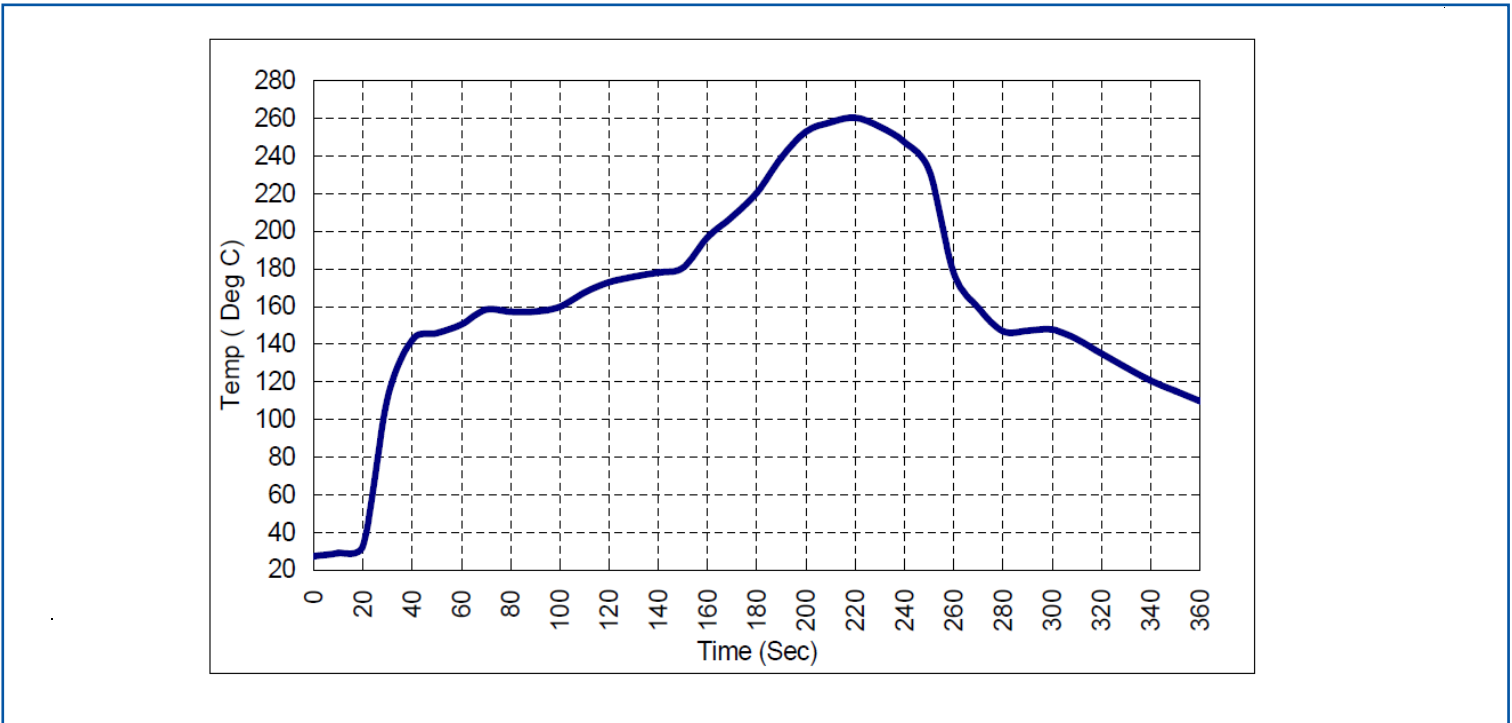

Surface Mount 719.0MHz SAW Filter

AFS20A05-719.00-T2



RoHS
Compliant

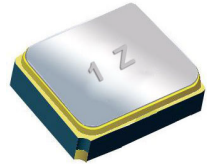

2.0 x 1.6 x 0.9 mm

PACKAGING: 2,000 units/reel

Reel Dimensions

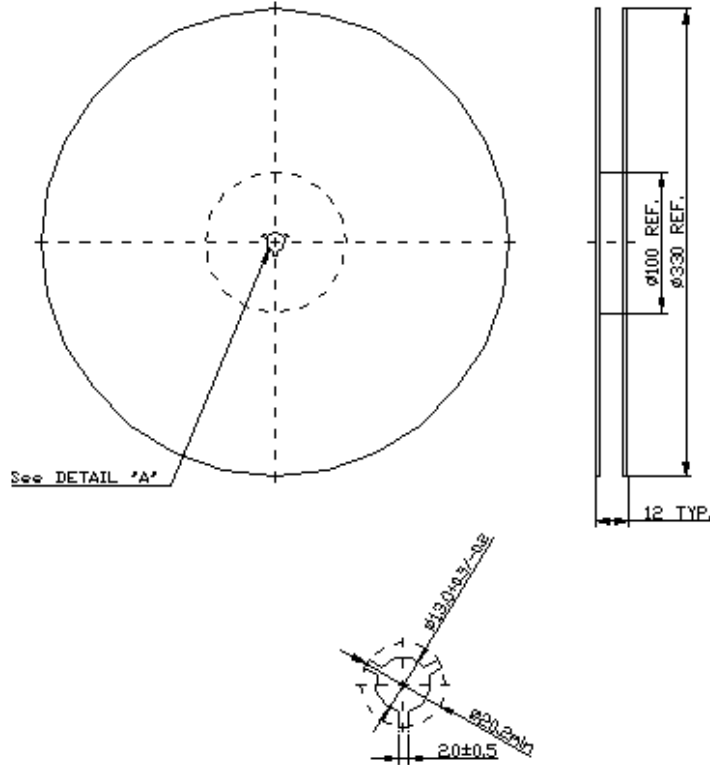

Tape Dimensions

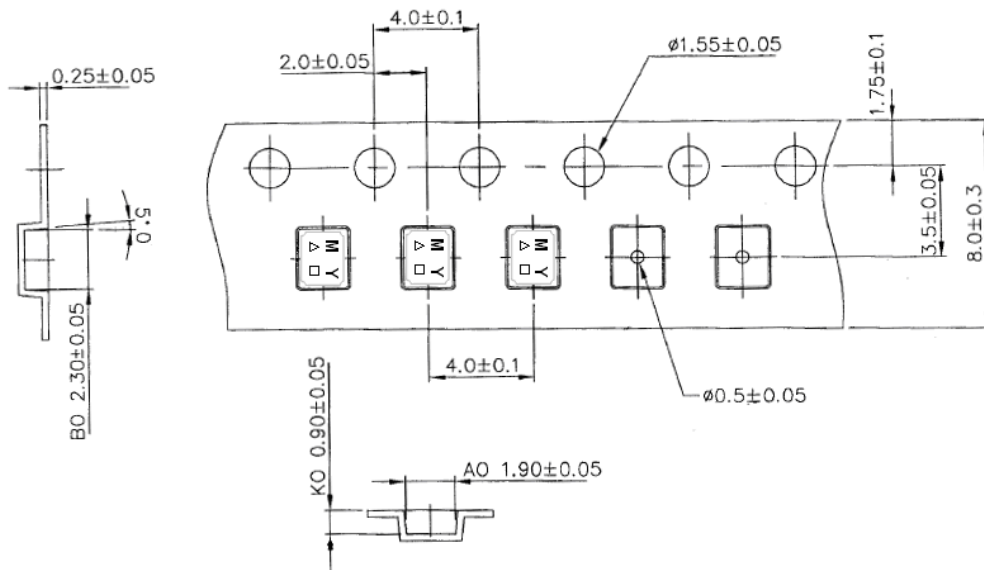

ATTENTION: Abracon Corporation's products are COTS – Commercial-Off-The-Shelf products; suitable for Commercial, Industrial and, where designated, Automotive Applications. Abracon's products are not specifically designed for Military, Aviation, Aerospace, Life-dependant Medical applications or any application requiring high reliability where component failure could result in loss of life and/or property. For applications requiring high reliability and/or presenting an extreme operating environment, written consent and authorization from Abracon Corporation is required. Please contact Abracon Corporation for more information.

ABRACON IS
ISO 9001:2008
CERTIFIED



Visit www.abracon.com for Terms & Conditions of Sale
30332 Esperanza, Rancho Santa Margarita, California 92688
tel 949-546-8000 | fax 949-546-8001 | www.abracon.com

Revised: 08.19.11