

Product Document



User Guide

UG001008

Illuminator Evaluation Kit

User Manual

EVALKIT_Illuminator

v1-00 • 2021-Mar-09

Content Guide

1	Introduction	3	4.11	How to Connect a Fast LVDS Trigger	30
1.1	Kit Content.....	3	5	How to Operate the Board.....	32
1.2	Ordering Information	4	5.1	Possible Thermal Issues	32
1.3	Safety Information	4	5.2	Connecting Oscilloscope Probes	33
2	Specifications Overview	5	5.3	Measuring the Cathode Voltage	33
2.1	Board Architecture.....	5	5.4	Taking Confidence Using a Resistive Dummy Load	34
2.2	Main Features	6	5.5	Measuring a Starboard-Mounted Laser with 1 μ s Pulse Length	39
2.3	Absolute Maximum Ratings.....	7	5.6	Measuring a Socket-Mounted (or Soldered) Laser with 1 μ s Pulse Length	45
2.4	Performance Characteristics	7	6	Troubleshooting	51
3	Hardware Description	10	6.1	Red LED DL1 is ON: Driver Fault.....	51
3.1	Board Settings	10	6.2	Yellow LED DL4 is ON: Board-Level Error ..	51
3.2	External Connections	10	6.3	No Current: Check Electrical Integrity of Output	52
3.3	Controls and Indicators	12	6.4	Sudden Board-Level Error While Using LVDS	52
3.4	Mechanical Interface	12	7	Annex.....	53
3.5	External Power Supply	13	7.1	Board Settings Configurations.....	53
4	Getting Started	16	7.2	External Connections	54
4.1	Illuminator Connection and the Influence of Inductance.....	16	7.3	Controls and Indicators.....	55
4.2	Setup of a Safe Starting Condition	16	8	Revision Information	57
4.3	How to Set the Laser Supply Voltage	17	9	Legal Information.....	58
4.4	How to Measure the Laser Current and Its Voltage Drop.....	18			
4.5	How to Minimize Readout Offset.....	19			
4.6	How to Connect the VCSEL Illuminator	21			
4.7	How to Set the Bias Current.....	24			
4.8	How to Set the Pulsed Current Amplitude..	25			
4.9	How to Set the PWM Oscillator	27			
4.10	How to Connect a Camera Master Strobe Signal.....	28			

1 Introduction

The illuminator evaluation kit EVALKIT_Illuminator intends to provide a flexible hardware interface to drive laser diodes in different application contexts using 2D based imaging systems as well as 3D time-of-flight systems.

With the kit, the user is able to drive most of **ams**' illuminator modules to allow the user to evaluate easily the performances of the product.

It is the user's responsibility to take care of the eye safety compliance at system level.

1.1 Kit Content

The shipment box of the Illuminator Evaluation Kit contains the following items:

- The Illuminator Evaluation Kit board
- The external AC/DC power adapter in its own cardboard box
- A small plastic bag with a 1 Ω high power resistor to use as a dummy load for testing

The shipment box does not include the C13 wall plug so it is on the user to get the suitable C13 plug fitting with the region.





Figure 1:
Pictures of the Kit Content



1.2 Ordering Information

Ordering Code	Description
EVALKIT_Illuminator	Illuminator Evaluation Kit

1.3 Safety Information

	<p>The device is only intended for laboratory testing use by trained personnel. Use by general public users has to be avoided.</p>
	<p>Even during normal operation of the device, the heatsink and some of the parts mounted on the board could become hot, with temperature up to 110°C for specific components.</p> <p>Provide stable mechanical mounting of the device and assure proper ventilation.</p> <p>Do not touch the device during operation and allow sufficient time to cool down after shut-down before handling it.</p>
	<p>The device is intended to drive high power laser diodes, which can be harmful to eyes.</p> <p>Check the compliance of the experimental setup to all present laser safety regulations before operating the device.</p> <p>Wear protection glasses while operating.</p>
	<p>This electronic product is subject to disposal and recycling regulations that vary by country and region: check for applicable rules on your site.</p> <p>In general, do not dispose waste electronic equipment in standard waste receptacle.</p>

2 Specifications Overview

2.1 Board Architecture

The Illuminator Evaluation Kit intends to provide a flexible hardware interface to drive VCSEL diodes in different application contexts. It allows to independently set a pulsed modulation current and a continuous bias current, using trimmers or applying external control voltages.

A variety of digital interfaces allow to apply an external strobe signal, which sets both pulse rate and duty cycle. An on-board oscillator at 100 kHz is also present, which provides variable duty cycle PWM and interacts with the external strobe signals with an AND logic. On-board analogue electronics makes easier to interface to an external oscilloscope to acquire the laser current waveform, as well as the voltage drop across the laser.

The device requires a single external supply and internally generates all the voltages required by the different electronics parts.

The board is based on the integrated laser driver circuit [iC-HG30](#) from IC-Haus.

Figure 2:
Block Diagram of the Illuminator Evaluation Kit

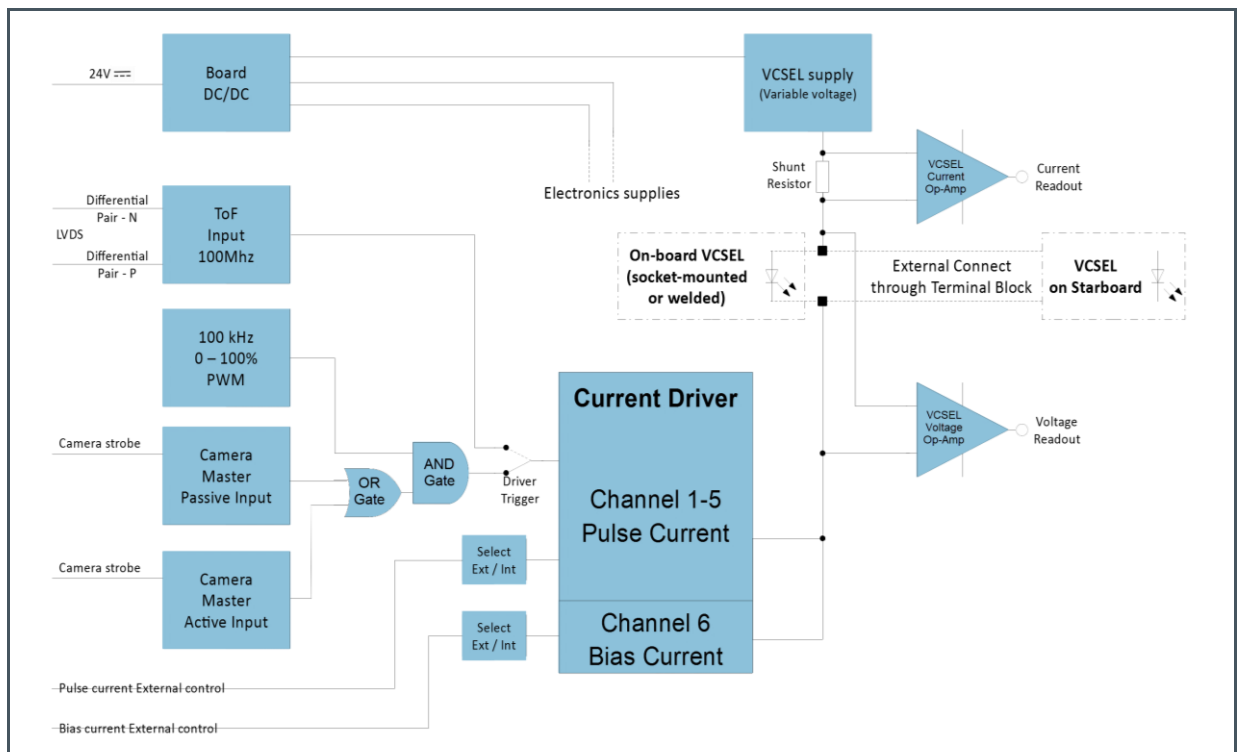

2.2 Main Features

The main features of the Illuminator Evaluation Kit are listed as follows:

- Laser driving:
 - Constant current operation
 - Up to 20 A pulsed current and up to 1 A bias current, with independent analogue settings
 - Selectable external or internal current control
 - Adjustable anode supply voltage to optimize speed or to support the external connection of multiple lasers in series (low-speed applications)
- Laser triggering:
 - Differential input trigger for high-speed applications (Time-of-Flight) up to 100 MHz
 - Camera Master strobe inputs for 2D Camera applications
 - On-board PWM oscillator, 100 kHz, 0–100% duty cycle
- Laser connection
 - Screw terminal block suitable for externally mounted devices
 - Soldering pads (socket-mount option) intended for high-speed applications, if using lasers with specific or compatible footprints as shown in Figure 3.
- Signal outputs for the electrical laser parameters, with different scales and bandwidth
- 24 V nominal supply voltage
 - External AC/DC adapter included
 - On-board ON/OFF sliding switch
- Operating ambient temperature range: 0 to 40 °C (non-condensing)
 - Restrictions may apply depending on the set laser current and modulation parameters
 - Over-temperature protection operates
 - Use of the provided heatsink is compulsory

Figure 3:
Module Bottom Pads Footprints Compatibility with the Kit Soldering Pads

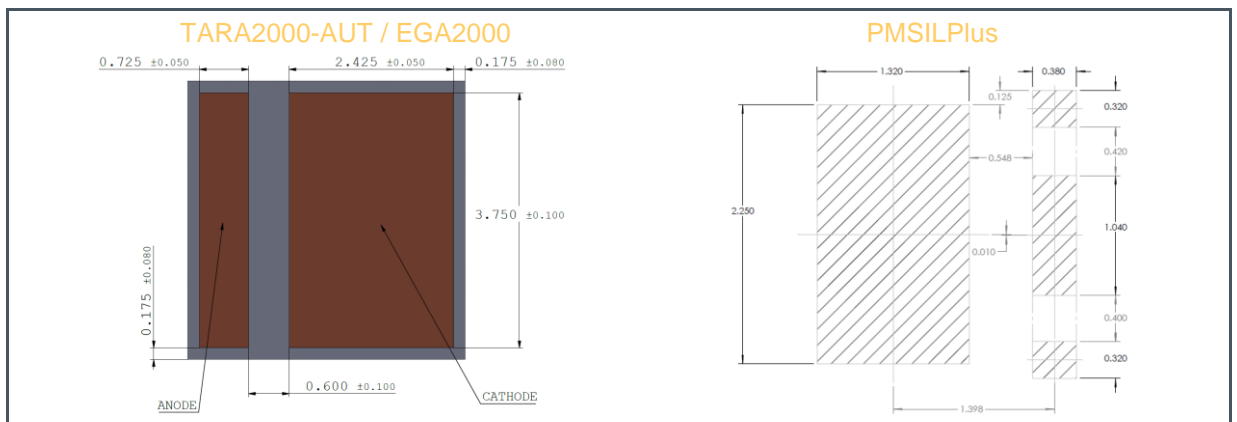

2.3 Absolute Maximum Ratings

Stresses beyond those listed under “Absolute Maximum Ratings” may cause permanent damage to the device. These are stress ratings only. Functional operation of the device at these or any other conditions beyond those indicated under “Operating Conditions” is not implied. Exposure to absolute maximum rating conditions for extended periods may affect device reliability.

Figure 4
Absolute Maximum Ratings of the Illuminator Evaluation Kit

Symbol	Parameter	Min	Max	Unit	Comments
Electrical Parameters					
I_{pulsed}	Pulsed Laser Current (With Heatsink)	0	20	A	Pulse length 10 ns Average duty cycle < 2% No bias
V_{supply}	Supply Voltage	20	28	V	
I_{biased}	Biased Laser Current (With heatsink)	0	1	A	
Temperature Ranges and Storage Conditions⁽¹⁾					
T_A	Operating Ambient Temperature	0	40	°C	
T_{STRG}	Storage Temperature Range	-20	70	°C	
$RH_{NC, op}$	Operating Relative Humidity (non-condensing)	20	90	%	
$RH_{NC, STRG}$	Storage Relative Humidity (non-condensing)	10	95	%	

(1) By design, not actually tested

2.4 Performance Characteristics

Figure 5:
Electrical Parameters

Parameter	Conditions	Min	Typ	Max	Unit
External Supply Voltage		22	24	26	V
Operating Mode		Constant current controller			
Star-board-mounted VCSEL Pulsed Current (see Figure 27 for setting) With heatsink in still air at 20 °C	Anode voltage $V_{driver} = 6\text{ V}$ Frequency 100 kHz Duty cycle 50% No bias	0	5	6	A

Parameter	Conditions	Min	Typ	Max	Unit
Socket-mounted VCSEL Pulsed Current (see Figure 27 for setting) With heatsink in still air at 20°C	Anode voltage $V_{\text{driver}} = 6 \text{ V}$ Frequency 100 kHz Duty cycle 10% No bias	0	15	18	A
	Anode voltage $V_{\text{driver}} = 20 \text{ V}$ Pulse length 10 ns Average duty cycle < 2% No bias	0	15	18	A
	Anode voltage $V_{\text{driver}} = 6 \text{ V}$ Frequency 100 MHz Duty cycle 50% No bias	0	4	5	A
	Anode voltage $V_{\text{driver}} = 6 \text{ V}$ Frequency 100 kHz Duty cycle 50% No bias	0	4	5	A
	Anode voltage $V_{\text{driver}} = 6 \text{ V}$ Frequency 100 kHz Duty cycle 20% No bias	0	8	10	A
VCSEL Bias Current ⁽²⁾ (With heatsink in still air at 20 °C)	Bias enabled (board jumper)	0	1	1.5	A
Pulse current setting with a voltage	Internal	12-turn Trimming Potentiometer			
	External Range	0		5	V
	External Bandwidth ⁽¹⁾		2		MHz
Bias current setting with a voltage	Internal	12-turn Trimming Potentiometer			
	External Range	0		3	V
	External Bandwidth ⁽¹⁾		2		MHz
VCSEL anode voltage range (V_{driver})		5.3		21.3	V
VCSEL anode voltage setting	Internal	12-turn Trimming Potentiometer			
VCSEL current readout	TP15 Scale		100		mV/A
	Bandwidth ⁽¹⁾		2		MHz
	TP15 Scale		1000		mV/A
	Bandwidth ⁽¹⁾		0.2		MHz
	TP8 Scale		2.5		mV/A
	Bandwidth ⁽¹⁾		300		MHz
VCSEL Anode-Cathode voltage readout	TP14 Scale		500		mV/V
	Bandwidth ⁽¹⁾		10		MHz
	TP10 Scale		50		mV/V
	Bandwidth ⁽¹⁾		450		MHz
Thermal Resistance Driver/Ambient	With heatsink		9		°K/W
	Without heatsink		30		°K/W

(1) By design, not actually tested

(2) Heat dissipation due to bias current reduces pulsed maximum current and/or duty cycle

Figure 6:
Mechanical Parameters

Parameter	Value	Unit
Driver Overall Dimension (included heatsink and components height)	115 x 95 x 23	mm
Driver weight	270	g
External AC/DC adapter dimensions	125 x 50 x 31.5	mm
External AC/DC weight	300	g

3 Hardware Description

3.1 Board Settings

The setting flexibility of the Illuminator Evaluation Kit is ensured with the on-board jumpers in order to set different configurations. The below picture helps locating them on the board and in the Annex chapter of this document is showing a detailed table list for the board configurations.

Figure 7:
Location of the Configuration Jumpers on the Board

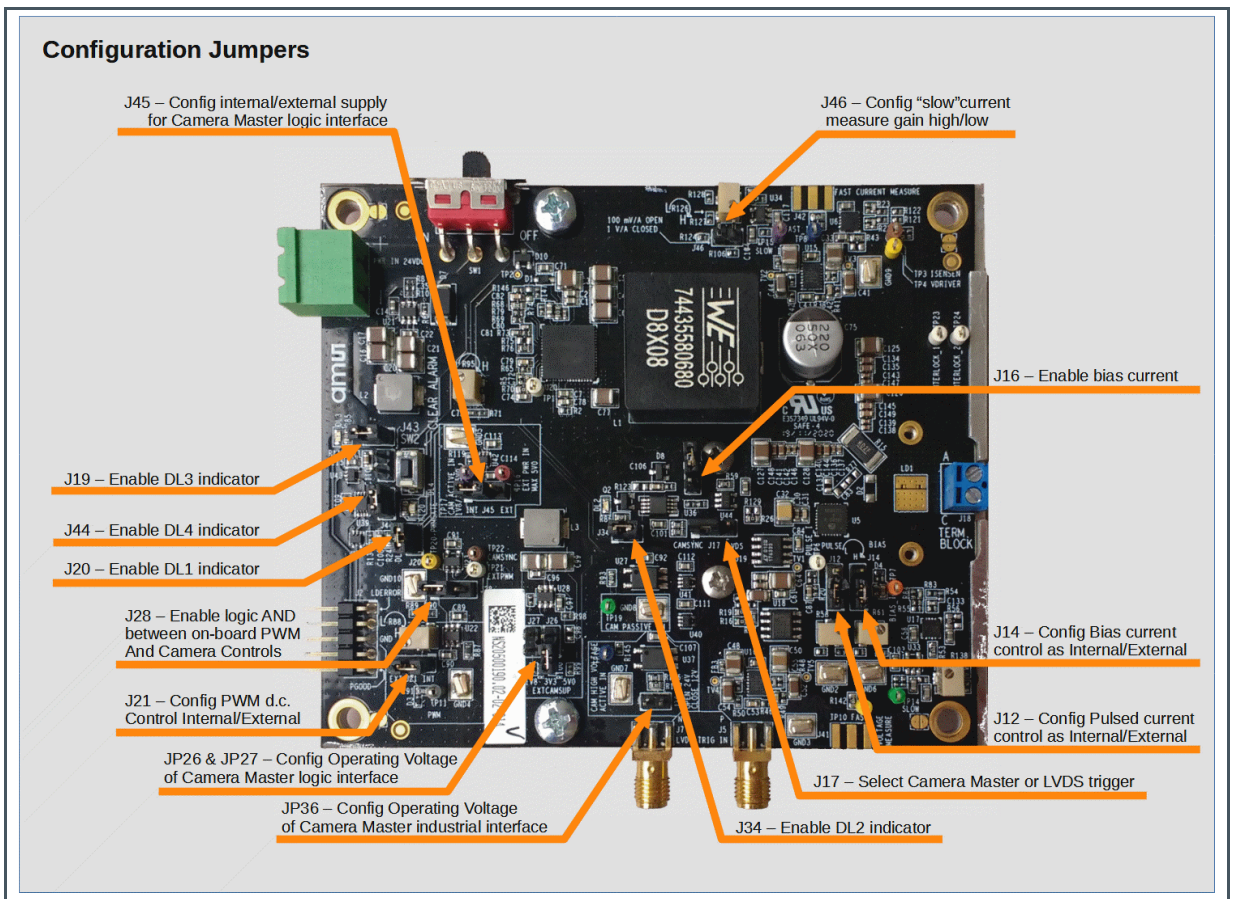

3.2 External Connections

In order to allow the user to use easily the evaluation kit, the board has several input and output connections as shown on the picture below. Several ground-loops, sequentially numbered with a prefix “GND”, are located in different positions on the board to ease ground connection of any external

equipment. The Annex chapter of this document is showing a detailed table list to describe further the different external connections.

Figure 8:
Location of Board Connectors

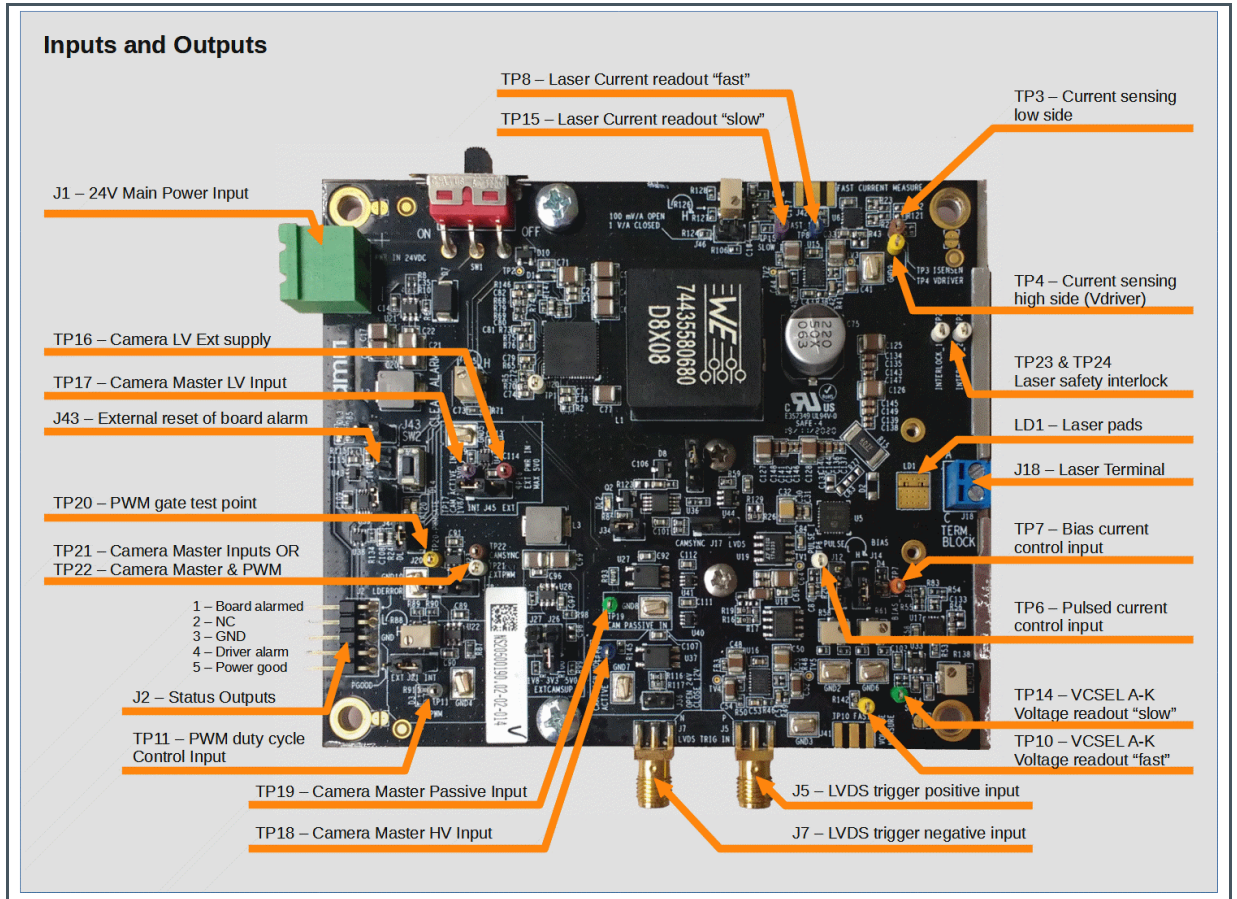

In the annex, there is a table listing the signals available on the pins of the status connector J2.

3.3 Controls and Indicators

The board has also different controls and light indicators as shown in the figure after. The Annex chapter of this document is showing a detailed table list to describe controls and indicators on the board.

Figure 9:
Location of Board Controls and Indicators

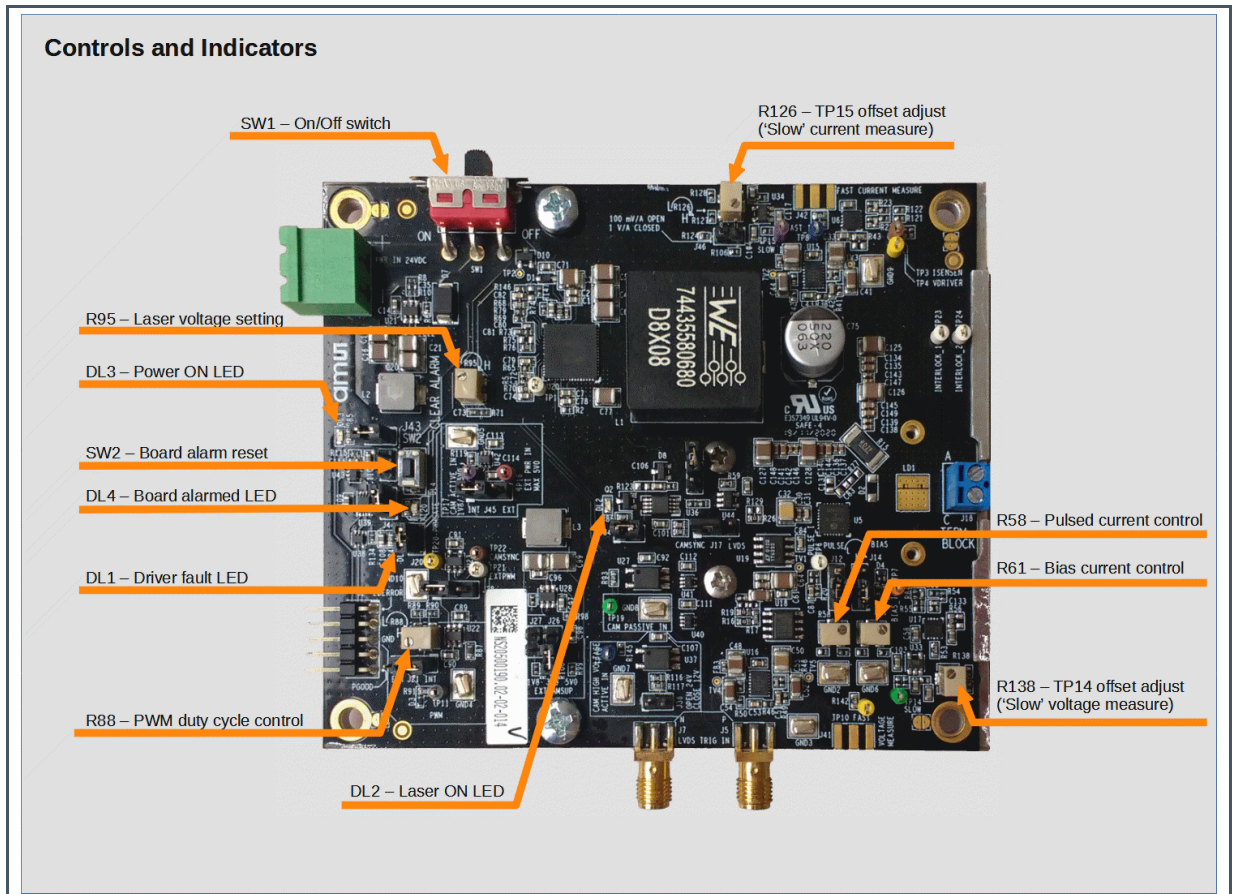

3.4 Mechanical Interface

The Figure 10 below shows the position of the mechanical fixing holes for an easy-handling of the board as follow:

- Four pass-through M4 holes provided to mount the board on a suitable base
- Two pass-through M4 holes usually intended to fix the board onto its heatsink
- Two pass-through M3 holes intended as fixings to better attach the heatsink
- Two pass-through M2 holes intended to mount the optional laser socket or to be used as further auxiliary fixings to better attach the heatsink

Figure 10:
Mechanical Interface

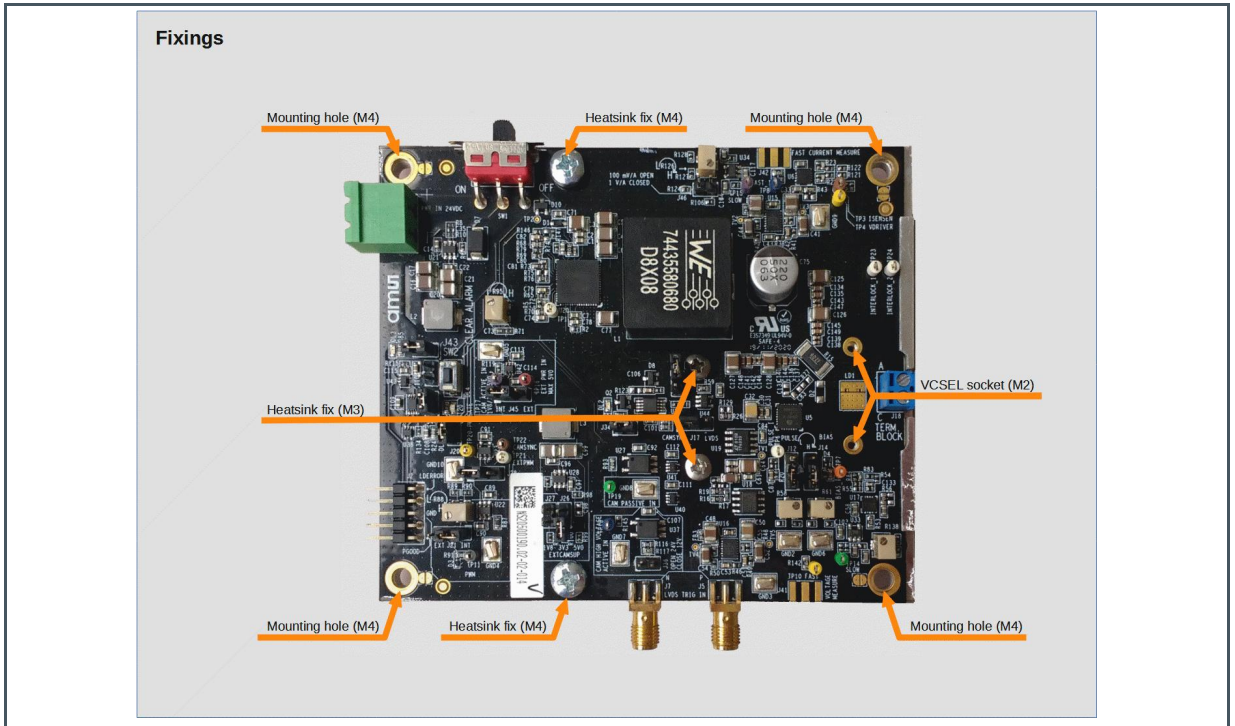

3.5 External Power Supply

An AC/DC adapter is delivered with the Illuminator Driver to provide the required 24 V supply. The Figure 11 below shows how to connect it to the green J1 socket, and the main specifications.

Figure 11:
Power Supply and Its Specifications



Specification	Value
INPUT voltage range	100 – 240V~, 50 – 60Hz, 1.4A max
OUTPUT voltage	24V $\overline{\text{---}}$, 2.5A
Power rating	60W
Operating Temperature	-30 – 50 °C
Operating Humidity	20 – 90 % non-condensing
Storage Conditions	-40 – 85 °C 10 – 95 % RH non-condensing

In case the user has to use a different supply within the experimental set-up, here follow some more information about the power requirements.

- Supply input socket: Phoenix Contact MSTBA_2,5/2-G-5,08 (P/N 1757242)
- Mating plug: MSTB_2,5/2-ST-5,08 (P/N 1757019)
- Wiring: See below (board protected against polarity inversion)
- Power consumption: Application dependent, see below

Figure 12:
Connection of the Supply Input

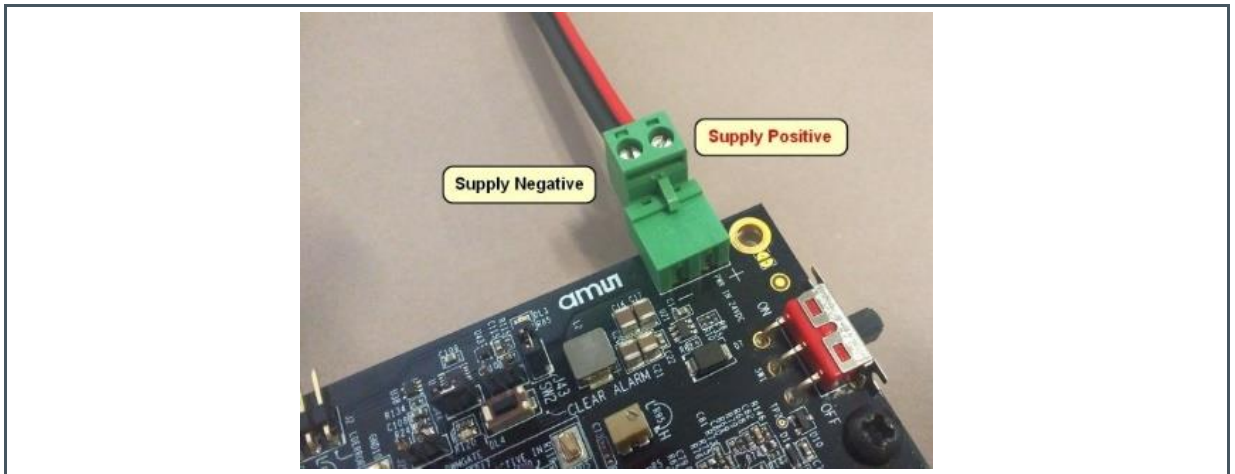

About power consumption, let's define that Stand-by refers to being the board powered-on without any trigger or strobe applied and with the laser bias current disabled. The connected load is thus not operating in any way. In this condition, current consumption depends mainly on the setting of the supply voltage to the laser. The Figure 13 below shows the typical trend of the current drained from an external supply at 24 V versus the set laser voltage value. Note that, on the supply voltage range, some dependence of the stand-by current on the external voltage exists, but it is usually within ± 10 mA. Looking at the stand-by current level may be useful as an at-a-glance check that nothing anomalous is occurring.

Figure 13:
Typical Value of the Current Drained in Stand-by From a 24 V External Supply

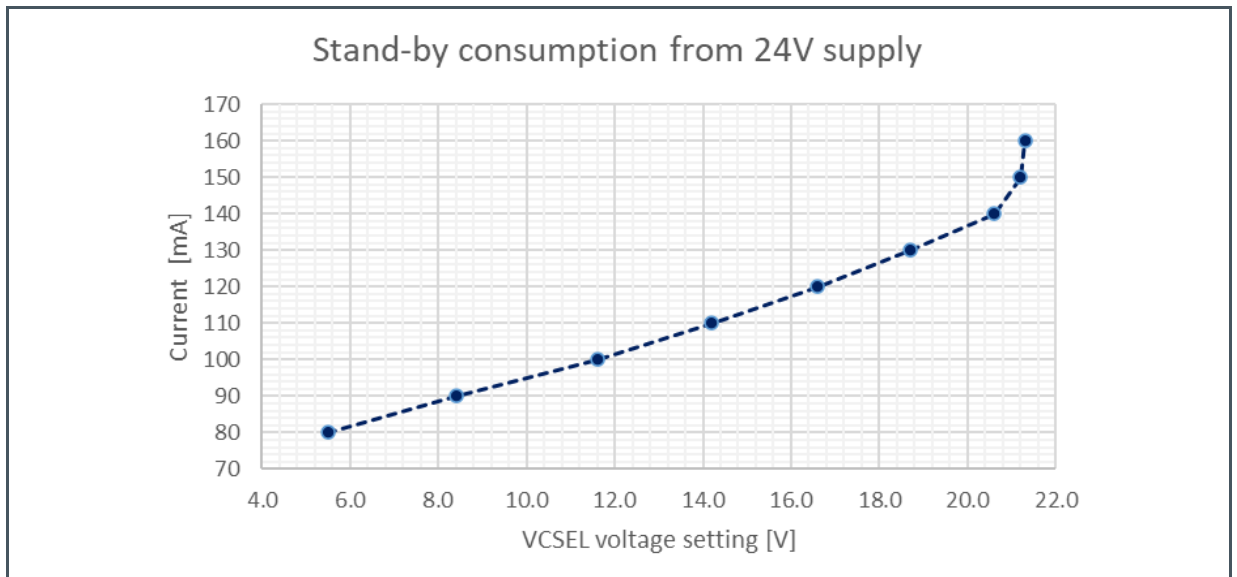

Operating power consumption depends on the setting of the laser voltage, on the laser current and on the pulse duty cycle. The following formula can be used to estimate it at the nominal 24 V supply:

$$I_s \text{ [mA]} \approx I_{SB} + (I_{LCW} + I_{LP} * P_{DC}) * V_{driver} / 24$$

where I_s is the current drained from the external supply, I_{SB} is the stand-by current, I_{LCW} the laser bias current, I_{LP} the peak value of the pulsed component of the laser current, P_{DC} the pulse duty cycle, assumed rectangular, and V_{driver} the laser supply voltage.

4 Getting Started

This section introduces general concepts about the use of the Illuminator Evaluation Kit and provides information about basic operations. All of this will be then put together presenting some real measures taken using the board.

4.1 Illuminator Connection and the Influence of Inductance

Laser connection considerations apply to any Illuminator Driver application, whether it uses long pulses at a relatively low frequency or requires short pulses at a high switching rate. The most important aspect is to keep the connection inductance as low as possible. The presence of stray capacitance is important too. The design of the board layout kept as a priority to minimize these stray parameters.

- *Direct soldering of the laser on the board* allows to get the best performance in terms of speed, but not practical when different devices have to be tested and compared. The use of the socket mounting option leads to very similar results and offers much more flexibility. These options are *especially suited for 3D ToF applications*.
- *Using the screw terminal block* is easy, but wiring adds much stray inductance. This solution is *more suitable for 2D camera applications*, which use longer pulse lengths. However, always keep the wires as short as possible. Also examine the contribution of the external mount, which will add some stray capacitance too.

The main effect of inductance and capacitance is to reduce the switching speed, putting a lower bound to the usable pulse length. They thus limit the minimum duty cycle in PWM applications or the maximum pulse rate in ToF systems. In general, an external connection is not suitable whenever pulses shorter than about 400 ns are involved.

It should also be considered that, whatever the pulse length, the inductance can reduce electronics reliability. In fact, since the switching edges of the laser current are fast, large voltage peaks occur that can exceed the maximum voltage rating of the driver. See next relevant sections about how to connect a laser.

4.2 Setup of a Safe Starting Condition

Preparing a new test setup requires following a sequence of steps designed to ensure the safety of both the operator, preventing the exposure to a dangerous level of laser light, and the board itself, avoiding any possible electrical damage.

Follow the below steps to start from a safe condition, whatever the foreseen application is:

- Verify that all the jumpers are correctly set for the experiment you intend to perform
- Mount the driver on a stable mechanical support
- Slide SW1 switch to OFF position (Figure 12)

- Remove any load from the J18 terminal block
 - If there is a laser, welded or in the socket, and it is not advisable to remove it, wear protective goggles in case of accidental laser emission
- Check the voltage of the external power supply
- Connect the external power supply to J1 (Figure 12)
- Switch-on the external power supply
- Slide SW1 switch to ON position and check LED DL3 lit
- Set to a minimum the pulsed current control, checking the value at J12 with a voltmeter. Depending on your configuration (Figure 14 below):
 - Turn counter-clockwise R58 until voltage reading at J12 is less than 500 mV
 - Check the external voltage applied to TP6 (white), possibly measuring it at J12
- In case a bias current is not required, open the J16 jumper and skip next step
- In case a bias current is required, start setting to a minimum the related control, checking the value at J14 with a voltmeter. Depending on your configuration (Figure 14 below):
 - Turn counter-clockwise R61 until voltage reading at J14 is less than 500 mV
 - Check the external voltage applied to TP7 (orange), possibly measuring it at J14

Figure 14:
Setting Bias and Pulse Currents

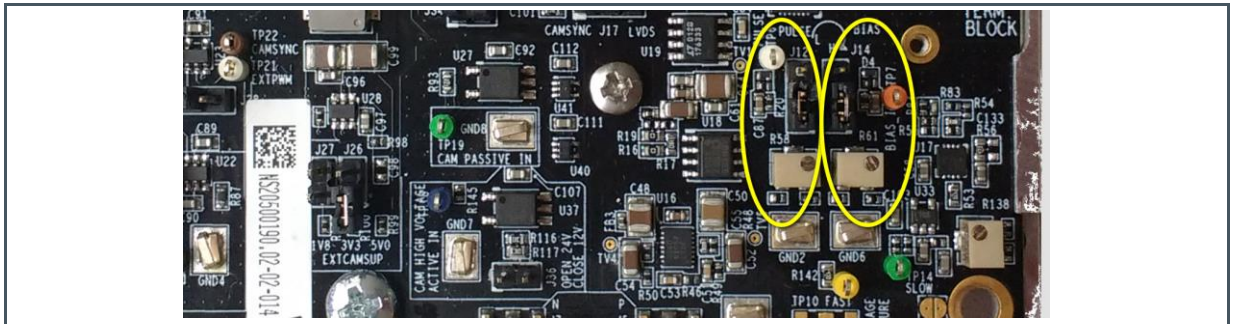

4.3 How to Set the Laser Supply Voltage

The voltage level at the VCSEL anode can be set at any voltage in the specified range (see Figure 7). The required minimum value depends on the voltage drops due to the standard device operation and to inductance. A 6 V minimum is typical, which computes as:

- 2 V required for the proper operation of the current controller
- 2-3 V to account for VCSEL cathode-anode voltage, depending operating current
- 1 V or larger, to account for inductive falls when switching

With pulse lengths shorter than some hundreds of ns, a higher anode supply voltage helps to get a better optical pulse shape, with faster fronts. The main drawback comes from the higher thermal load

that may make difficult to keep the driver cold. The actual setting will thus be a compromise between speed and the device operating temperature.

To set the voltage:

- Check SW1 is ON and LED DL3 lit
- Turn trimmer R95 clock-wise to increase, opposite to decrease (Figure 15 below)
- Measure voltage at TP4 (yellow) with a voltmeter

Figure 15:
Setting Laser Voltage Supply (V_{driver})

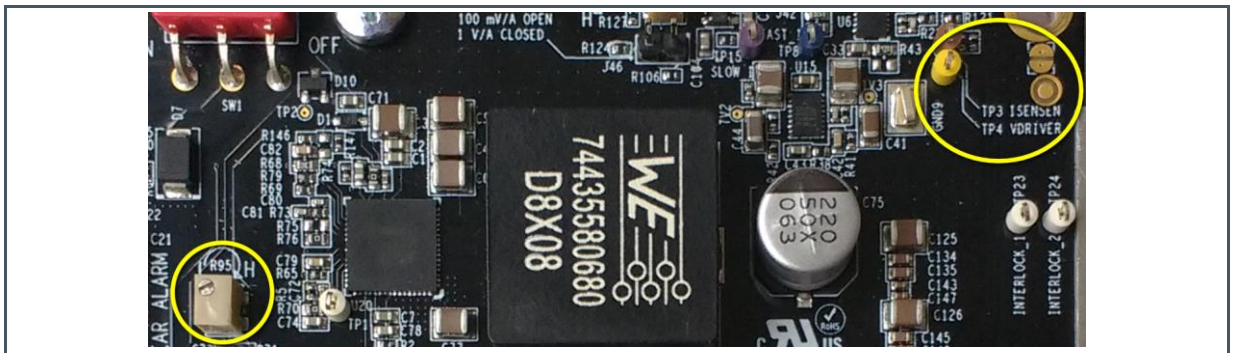

4.4 How to Measure the Laser Current and Its Voltage Drop

You can conveniently measure the laser current and the cathode to anode voltage at some test points, which differ for the measurement scaling and bandwidth figure 16 reports the gains to convert the voltage readings at the measuring point and the typical value of the measuring bandwidth. About listed measures, note that:

- Current scales refer to the use of the standard 0R02 (20mΩ) value for the R15 resistor
- All test points to be read using high impedance scope probes or a digital multimeter

Figure 16:
Gain and Bandwidth of the Measuring Points

Test Point	Description	Gain	BW
TP8 (blue)	“Fast” Current Readout	5 mV/A	300 MHz
TP15 (purple)	“Slow” Current Readout	100 mV/A (J46 open)	2 MHz
	“Slow” Current Readout	1 V/A (J46 closed)	0.2 MHz
TP10 (yellow)	“Fast” Laser Voltage Readout	100 mV/V	450 MHz
TP14 (green)	“Slow” Laser Voltage Readout	1 V/V	10 MHz

Test Point	Description	Gain	BW
TP4 (yellow) TP3 (brown)	Direct reading of voltage across the current sensing resistor.	Compute current as: Voltage difference (TP4 – TP3) / (R15 value)	Depends on used equipment
 Do not connect any of these test points to ground. Use high impedance multimeter or differential-mode scope probes. Any misuse can damage the board.			

Especially when dealing with short pulses, always consider the rated response bandwidth of the used test point. To get a complete and reliable information, we suggest the use of an oscilloscope to measure both the faster and the slower outputs, which helps to recognize bandwidth limitations too. You can also use a simple voltmeter, connected to the “slow” test points, to get some information about the laser voltage and current, but limitations exist in this case. The voltmeter only gives an average value of the parameter value, so a compensation and possibly further measures are needed to estimate maximum and minimum values.

4.5 How to Minimize Readout Offset

Electronics voltage offset affects the “Slow” readouts for both the laser voltage and the laser current. Measuring the peak-to-peak amplitude of the waveforms is free of any offset problem. However, a non-zero baseline badly affects getting data with a simple digital voltmeter and can annoy watching to oscilloscope traces. The driver has two separate controls to compensate for these offsets, although, depending on operating conditions, they could be only minimized but not nulled.

To get the minimum readout offset follow this procedure:

- Slide SW1 switch to OFF position (Figure 12)
- Do not apply any trigger or strobe signal
 - Possibly open J17 jumper to be sure of this (Figure 17 below)
- Do not apply any bias current
 - Possibly open J16 jumper to be sure of this (Figure 17 below)

Figure 17:
Disabling any Trigger and Bias (Opening J17 and J16)

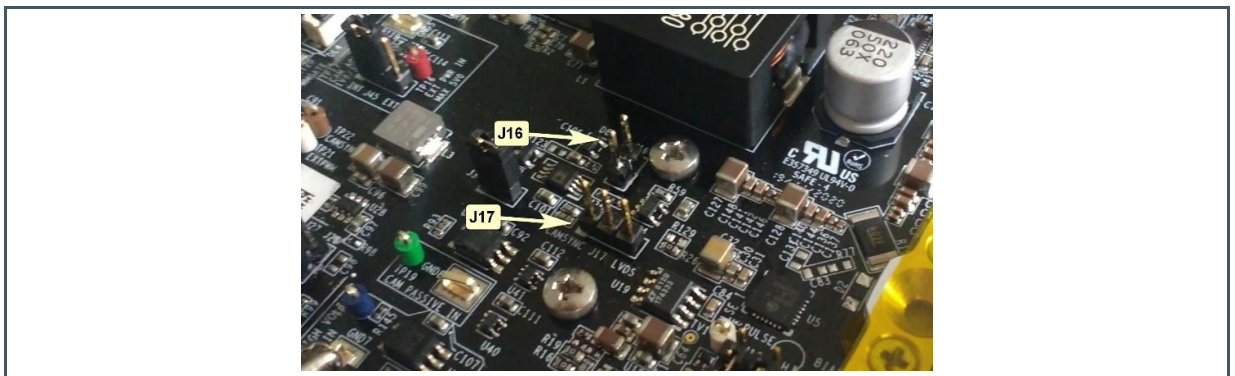

- Set the wished current measure gain using J46 (Figure 16 and Figure 19)
- Short the J18 contacts using a short wire (Figure 18)

Figure 18:
Shirting J18

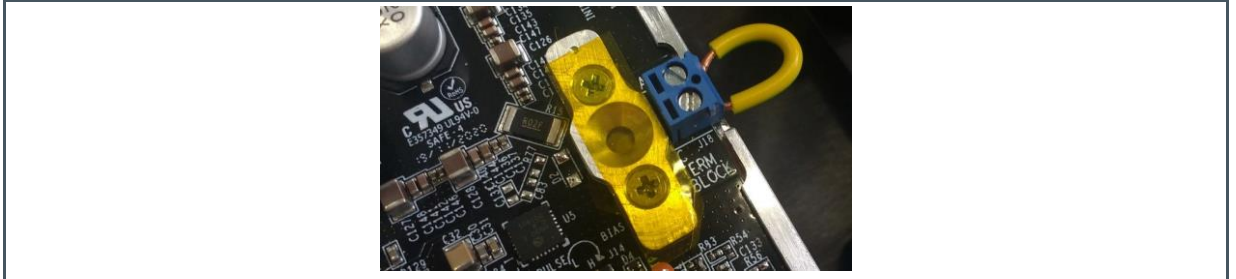

- Slide SW1 switch to ON position (Figure 12) and check LED DL3 lit
- Set the laser supply voltage at the wished value (section “How to set the laser supply voltage”)
 - Note that the offset of both the readout voltages usually changes toward negative values when the laser supply voltage increases to a higher level
- Minimize the offset of the TP15 (purple) current measure output (see Figure 19)
 - Measure offset at TP15 with a voltmeter
 - Adjust R126 to minimize voltmeter reading

Figure 19:
Adjusting TP15 Gain and Offset

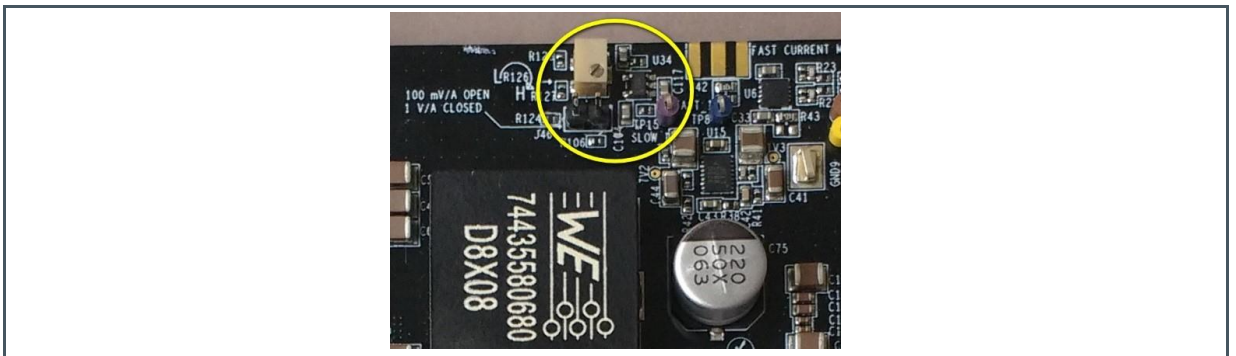

- Minimize the offset of the TP14 (green) voltage measure output (Figure 20)
 - Measure offset at TP14 with a voltmeter
 - Adjust R138 to minimize voltmeter reading

Figure 20:
Adjusting TP14 Offset

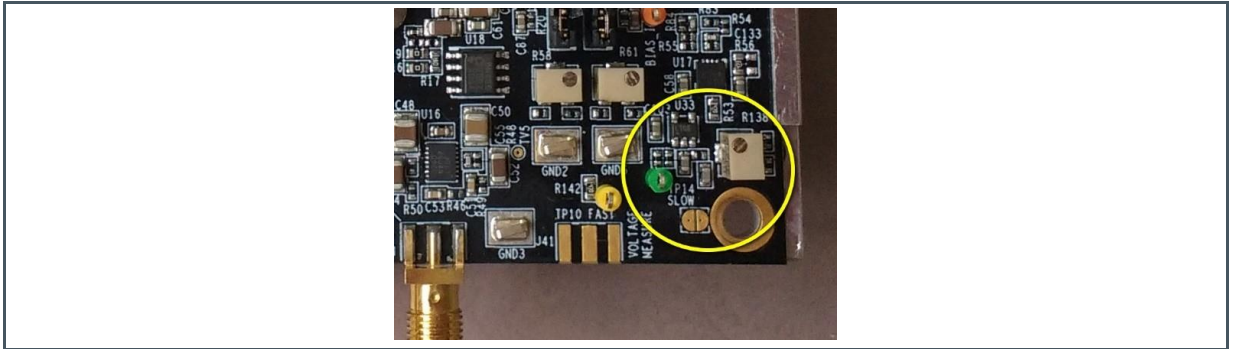

- Slide SW1 switch to OFF position (Figure 12)
- Remove the short from the J18 contacts
- Go on with other connections and actions

4.6 How to Connect the VCSEL Illuminator

- Slide SW1 switch to OFF position
- Use J18 (blue) terminal block for long-pulse applications (see previous hints about this)
- Use socket option or direct solder to on-board pads for highest speed

4.6.1 Using a Starboard Mounted Laser

To ease testing, the VCSEL can be available already mounted on a so-called “starboard”, a small printed circuit suitable for mechanical mounting. Depending on the wished thermal performance, the mounting substrate is FR4, Aluminum or Copper. Apart from heat conductivity and thermal capacity, the different versions have also somewhat different parasitic capacitance values. However, the main issue about starboards is the wires connecting to the laser driver.

The Figure 21 below shows the TARA2000-AUT / EGA2000 VCSEL modules mounted on two kinds of starboards and much different wiring. Connection on the left uses a twin stranded electrical cable that allows easy positioning of the laser off the board, but it adds a large amount of inductance. On the right, two short bare copper wires allow the shortest possible connection between the starboard and the terminal block, minimizing the inductance but forcing the laser position to near the board edge.

Figure 21:
TARA2000-AUT / EGA2000 VCSEL Modules Mounted on Starboards with Different Wiring



The Figure 22 below shows a star-board with the shortest-as-possible wires connected to J18. The laser socket is visible too, protected from dust by a piece of tape. To connect a wired star-board to the driver:

- Loose completely both the screws of the blue J18 terminal block
- Insert the wires in the terminal receptacles. Take care of VCSEL polarity. Anode side is to the top-right of the figure.
- Tight the screws, avoiding overtightening

	Take care of VCSEL Anode-Cathode orientation.
---	---

Figure 22:
Shortest Wiring Starboard Connected to the Driver



4.6.2 Using the Laser Socket

The use of the laser socket allows reducing much the connection stray inductance, so to get a much better performance in terms of speed. Mounting the VCSEL in the socket is not a difficult operation, but it nevertheless requires some care.

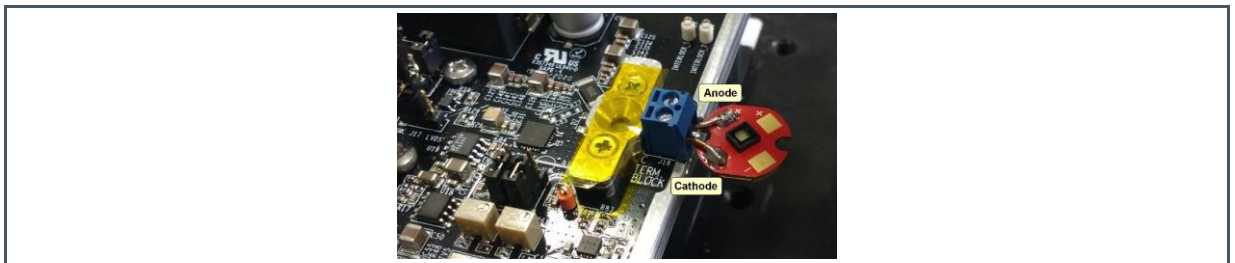
- Remove the protective tape
- Unscrew the socket cover to access the bottom part (see Figure 23 below)

	Do not ever remove the bottom part of the socket.
---	---

Figure 23:
The Socket Base



- Place the laser, centering it between the socket protrusions. Push it softly to be sure it is firmly in place. Look carefully to polarity: anode is on the side of the small notch drilled on the socket (top-right of the Figure 24 below)

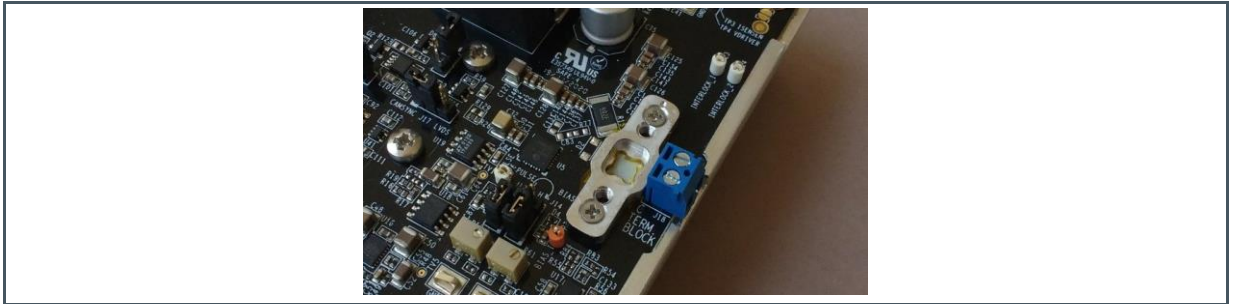

Take care of VCSEL Anode-Cathode orientation.

Figure 24:
A VCSEL Module Placed in the Socket Base

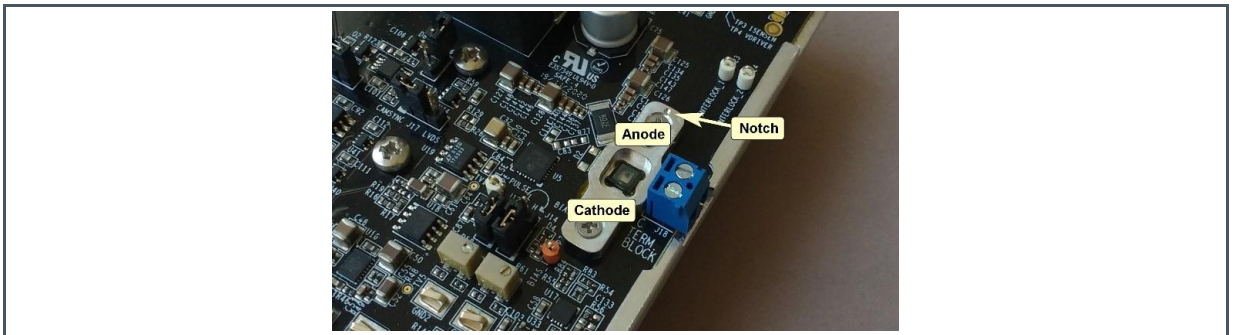

- Place the socket cover, taking care of its orientation. The small notches drilled on both the socket and the base have to be on the same side (top-right in the Figure 25 below).
- Fasten the screws slowly, so to fix the laser. Do not overtighten.

Figure 25:
A Socket-Mounted Module

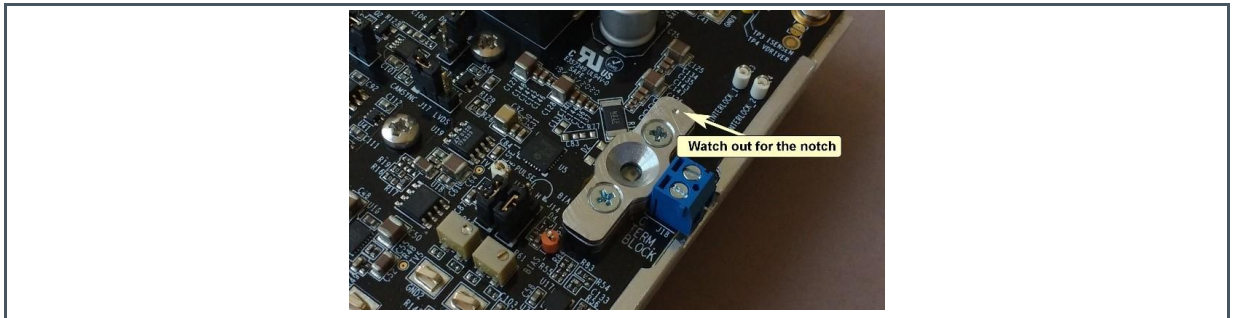

4.7 How to Set the Bias Current

	<p>WARNING: Apply safety rules to protect eyes from the CW laser output</p>
--	--

- Prepare to measure the bias current using one of the following approaches (Figure 16):
 - Use TP15 readout
 - Connect a voltmeter between TP4 and TP3
- Prepare to read control voltage value at J14 with a voltmeter (see below for reference only)

Figure 26:
Typical Control Voltage Values vs Bias Current at Room Temperature

Bias Current [A]	Control Voltage at J12 [mV]
0.00	0
0.01	842
0.05	1016
0.15	1146
0.30	1281
0.35	1320
0.40	1358
0.60	1499
0.60	1499
0.70	1567
0.80	1635
0.90	1704
1.00	1773

- Slide SW1 switch to ON position or check it is ON and LED DL3 lit
- Depending on your configuration and until the wished current level is reached:
 - Turn R61 (clockwise to increase)

- Set the external voltage applied to TP7
- Read control voltage at J14 and current according to your set-up
- Note that the actual current corresponding to a given control voltage value has a quite strong dependence on the driver temperature. The higher the temperature, the higher the control voltage value needed to get a given current value (see Figure 27 below from IC-HG30 data sheet)

Figure 27:
Typical Value of Current vs Control Voltage and Operating Temperature

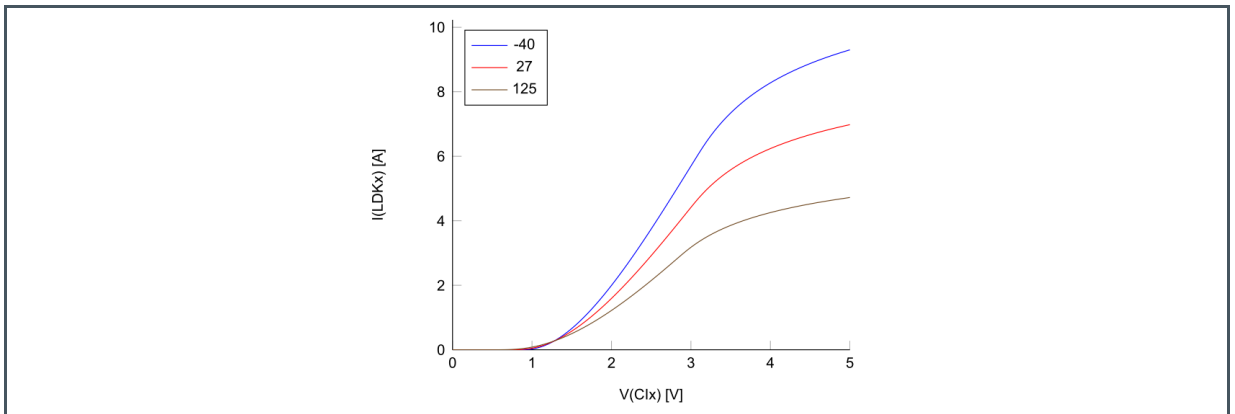

	<p>A setting done with a hot driver will result in an initially higher laser current at a cold start of the system.</p>
--	---

4.8 How to Set the Pulsed Current Amplitude

	<p>WARNING: Apply safety rules to protect eyes from the pulsed laser output</p>
--	--

The level control for the pulsed current has the same temperature dependence of the bias current one, but it is five times as sensitive because five current sources work in parallel to provide the required current. Data from Figure 27 still apply, but scale the current by a factor of five to get the real value. The Figure 28 helps showing typical setting values as measured from an actual device. The two curves account for the different amount of device heating while performing the measure.

Setting the pulsed current peak amplitude can actually be troublesome in case pulses shorter than about 400 ns are of interest. This is because of the bandwidth limitation of the TP15 “Slow” readout

and of the low gain and possibly noisy signal of the “Fast” TP8 output. In this case, two options are available:

- Refer to Figure 28 for the typical settings
 - In case an accurate control of the actual current level is needed, start from a lower current level and increase the control voltage slowly while letting the device temperature to stabilize
- Set-up the current using longer pulses first, if possible, and then apply the modulation pulse length needed by the actual application. In this case too, take in account the thermal response.

	<p>A setting done with a hot driver will result in an initially higher laser current at a cold start of the system.</p>
---	--

Figure 28:
Typical Values of Pulsed Current Amplitude vs Control Voltage

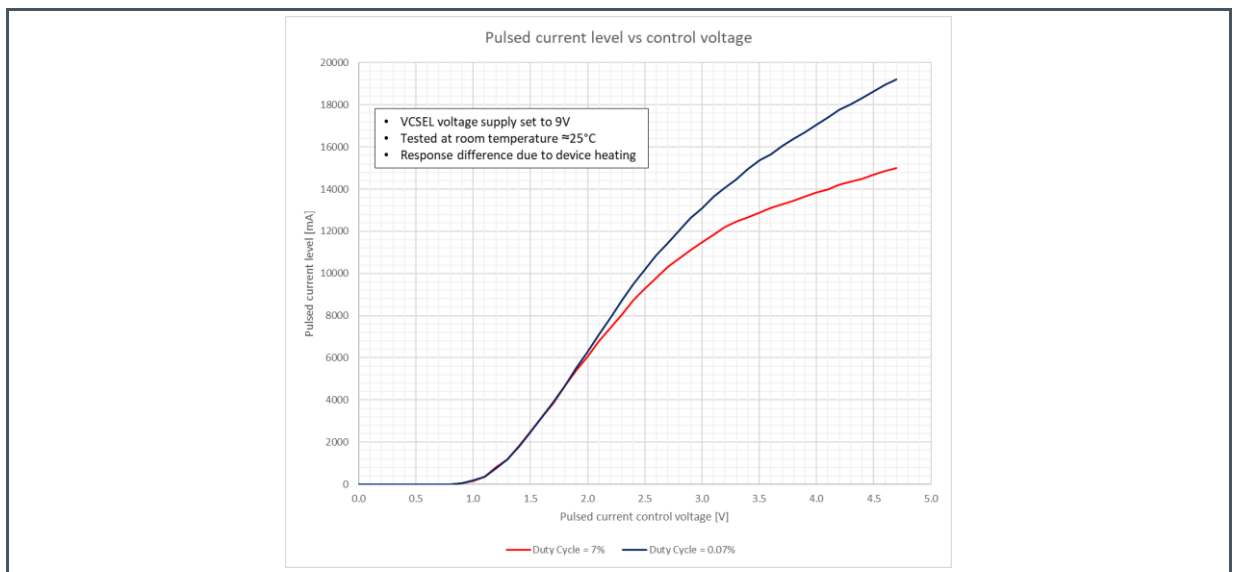

To set the current:

- Mount jumper J17 in the proper position for Camera Master or LVDS trigger
- Apply the required external trigger
- Set the pulsed current to the required level, reading at J12 using a voltmeter. Depending on your configuration:
 - Set using trimmer R58, turning clock-wise to increase
 - Apply an external voltage to TP6

- Depending on the actual test, pulsed current level can be conveniently read by looking to waveforms at TP8 and/or TP15
 - Note that because of switching noise and laser loop resonances, the waveform from the “fast” monitor output TP8 might be noisy

4.9 How to Set the PWM Oscillator

The on-board PWM oscillator provides pulses at 100 kHz rate with a variable duty cycle, which is regulated manually by R88 or externally voltage-controlled using the TP11 input (Figure 29 below).

To use it, first set the J28 and J21 jumpers:

- J28 actually enables/disables the use of the PWM oscillator. Close pins 1-2 to enable, while closing pins 2-3 disables.
- J21 sets whether the duty cycle is controlled by the board trimmer R88 (pins 1-2, marked INT) or by the external voltage connected between TP11 (Grey) and GND4 (pins 2-3, marked EXT). Actually, connect the ground reference to any of the available GND contacts.

The actual waveform from the PWM oscillator is monitored at TP20 (Yellow). In case it is disabled, you will find a fixed 5V level, but consider the same occurs for a 100% duty cycle waveform. Act on R88 or TP11 voltage to adjust the duty cycle.

Figure 29:
PWM Settings

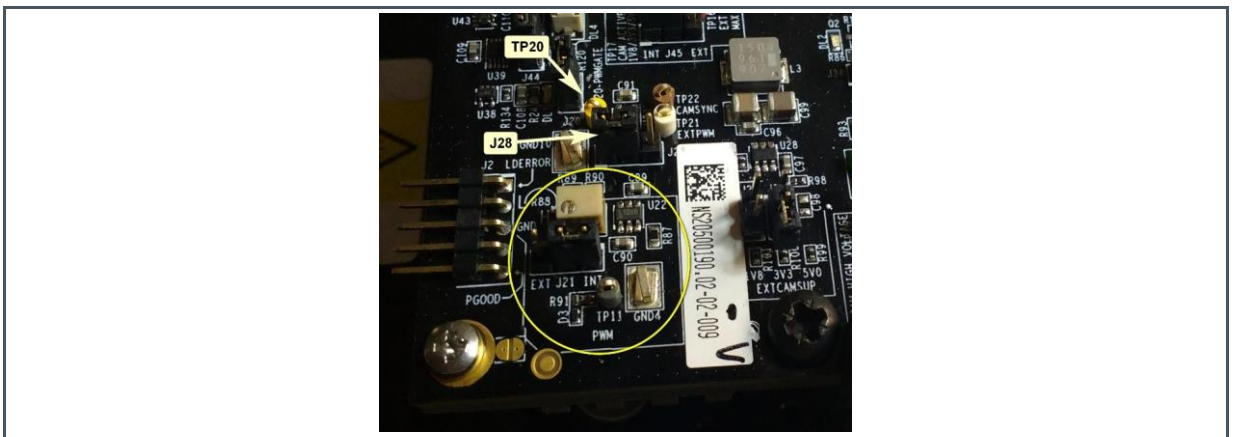

4.10 How to Connect a Camera Master Strobe Signal

4.10.1 Camera Master Passive Interface

The easiest way to operate the driver is making use of the Camera Master Passive Interface at the green TP19 input. It requires a clean contact shorts the input to ground, thus enabling the on-board PWM oscillator to actuate the current driver. The contact can be a mechanical switch, as well as a bipolar or a MOS transistor (see Figure 30 below).

Figure 30:
Camera Master Passive Input Circuit

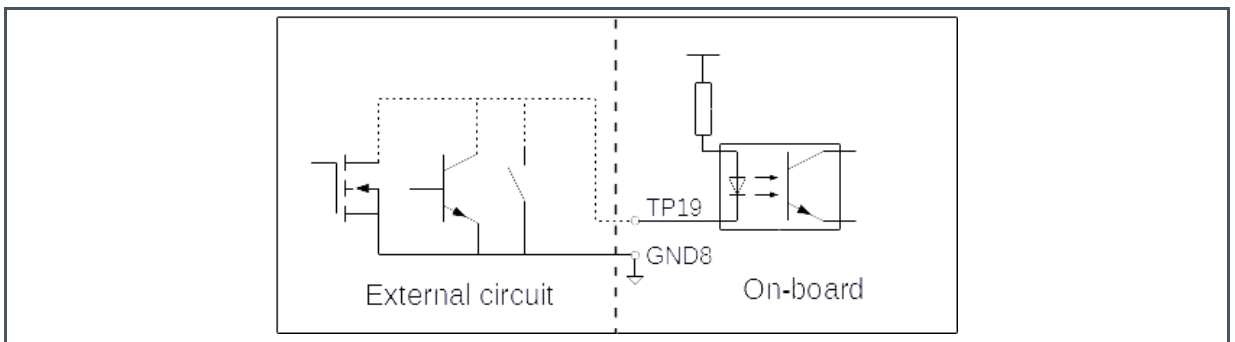

To go on:

- Place the jumper on the side marked as “CAMSYNC” of J17 (pins 1-2)
- Set the PWM oscillator as above described
- Connect the green TP19 to GND using your external circuitry. A simple, not-automated way to go is connecting TP19 to the nearby GND point of the board using a couple of clamp probes and a short wire (see Figure 31 below)

Figure 31:
Simple Activation of CAMSYNC

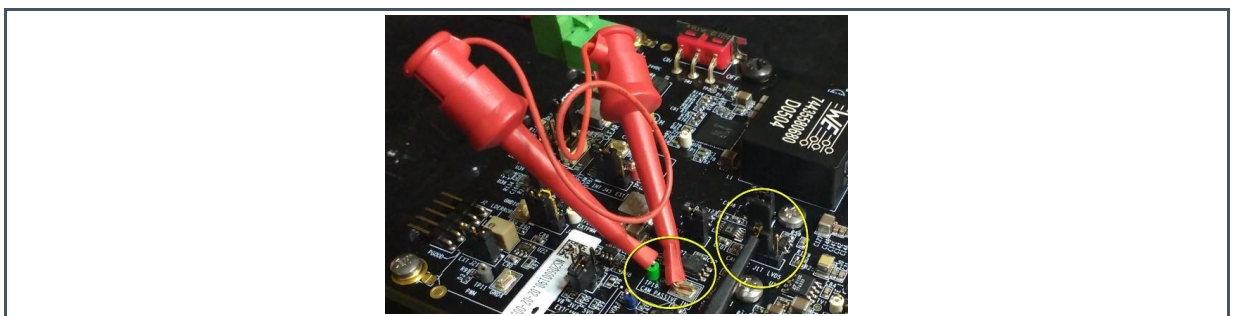

4.10.2 Camera Master Interface at Logistics Voltage Levels

In case a standard logic output is available from the camera, the Camera Master Interface at the purple TP17 input allows to use it (Figure 32). To go on:

- Set J45 jumper to select the voltage reference between “External” or “Internal”
 - In case the selection is “Internal”, set the voltage using J26 or J27:
 - 5.0 V logic: leave both open
 - 3.3 V logic: close J26 only
 - 1.8 V logic: close J27 only
 - In case the selection is “External”, connect your reference to the red TP16
- Connect your external strobe source to the purple TP17

Figure 32:
Camera Master Logic Input Circuit

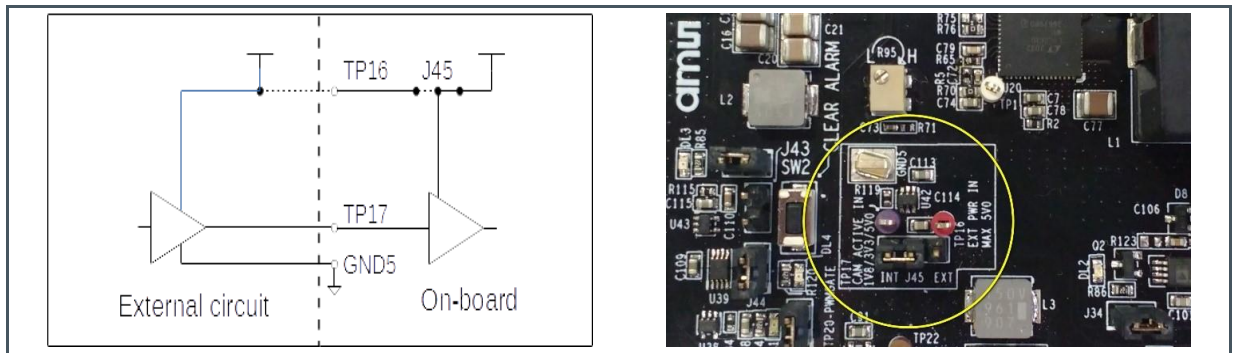

4.10.3 Camera Master Interface at Industrial Voltage Levels



In case the strobe output from the camera is at an industrial voltage level like 24 V or 12 V, the Camera Master Interface at the blue TP18 input allows to use it (see Figure 33 below). To go on:

- Set J36 jumper to select the voltage level
 - 24 V : Open
 - 12 V : Close
- Connect your external strobe source to the blue TP18

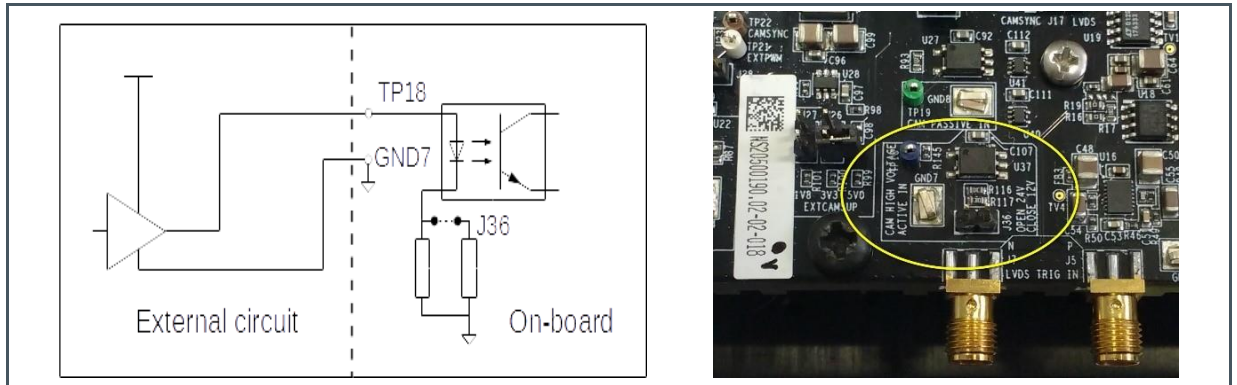
Figure 33:
Camera Master Industrial Input Circuit



4.11 How to Connect a Fast LVDS Trigger

	<p>Drive properly LVDS inputs when J17 is set for LVDS</p> <p>Keep LVDS_P < LVDS_N to prevent laser emission</p>
	<p>Do not leave LVDS inputs unconnected when J17 is set for LVDS</p>

The high-speed LVDS input requires to fulfil the specifications about voltage levels of the two input signals, according to the Figure 34 below.

Figure 34:
LVDS Levels

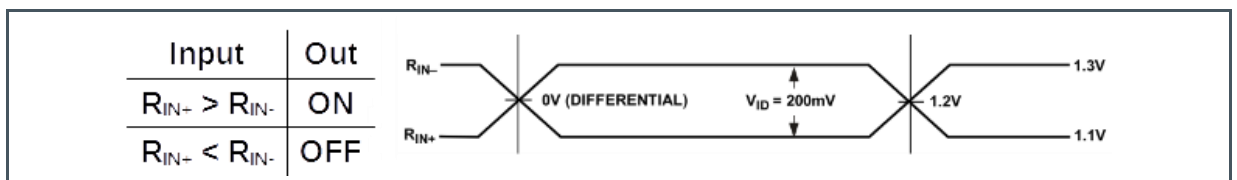

The output status is undefined with a differential input less than 200 mV. Do not to leave the inputs open and avoid they are at nearly the same level. Assure proper levels setting, notably when working with the emission of bursts. A wrong level setting between burst could result in laser being active while expected off.

- To use the LVDS trigger interface (see Figure 35 below)
- Set the J17 jumper on pins 2-3, on the side marked LVDS

Connect your differential LVDS signal to the SMA connectors marked LVDS_P and LVDS_N. Mind the proper polarity

Figure 35:
Connecting a LVDS Trigger⁽¹⁾

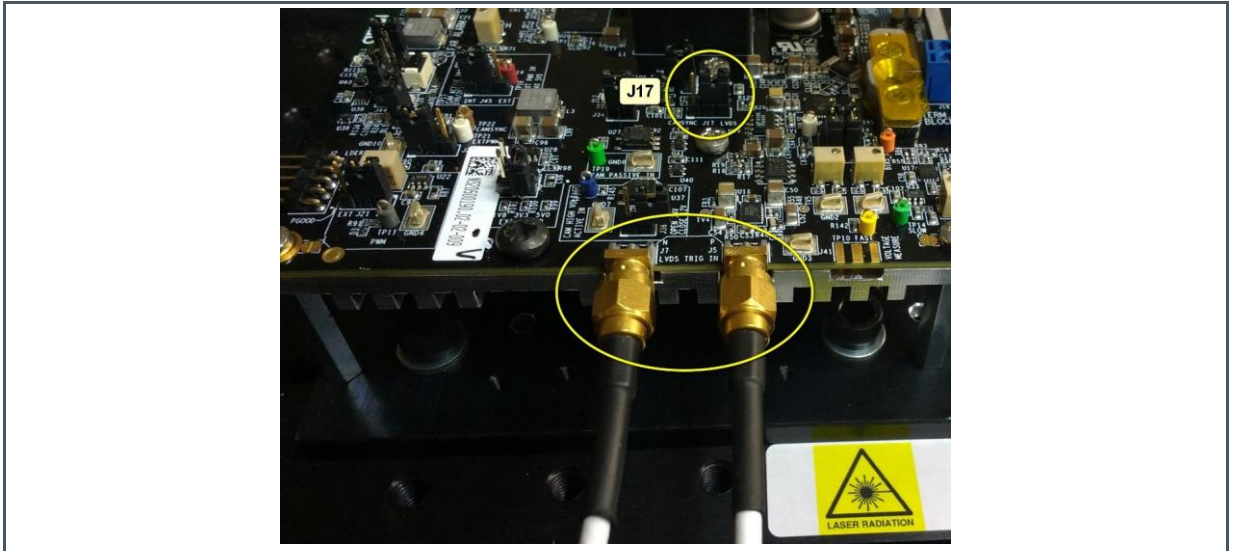

⁽¹⁾ Picture with board with the socket installed but the setup is valid without the socket

5 How to Operate the Board

Next sections present some use cases to illustrate how to operate the Illuminator Driver board. Before dealing with a laser, it is worth to practice using a resistive dummy load, without the additional risk of exposure to laser light and the possible damage of the VCSEL while setting the experiment. A high-power rated 1 Ω resistor is provided with the board to this purpose. Then, characterization tests of a star-board-mounted and a socket-mounted VCSEL will present.

5.1 Possible Thermal Issues

Depending on operating conditions, the driver supplies high average power to the laser, so much heat is dissipated on-board too. The temperature of some parts of the driver can rise over 60°C and, in some cases, even above 100°C too. The Figure 36 a) below shows the temperature distribution across the board at equilibrium, mainly due to a 10 W thermal load of the IC-HG30 current generator. Figure 36 b) is a more detailed view of the current generator area showing its measured temperature.

Figure 36:
Example of Temperature Distribution Across the Board

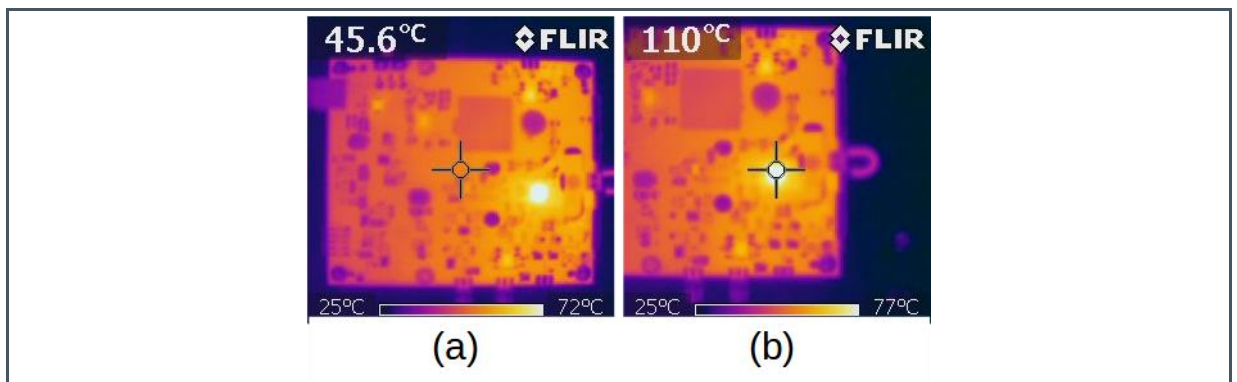

	<p>Driver IC temperature may exceed 100°C</p>
---	---

When its internal temperature goes over about 130 °C, the driver IC issues a fault signal and disables itself soon. That triggers a board-level alarm too. Laser operation cannot resume until a board reset, even after the device has cooled down. See more in the "Troubleshooting Section" later in this document.

Without its own heatsink, the temperature of the star-board carrying the VCSEL can rise above 100 °C too.

5.2 Connecting Oscilloscope Probes

To acquire all the useful waveforms, use an oscilloscope and connect it to the board using three 10 M Ω passive scope probes. In general, use the fourth channel, which a typical scope has, to connect a photodiode to detect the laser pulse. If available, active probes would allow to better appreciate fast details of the signals, but their usefulness depend on the specific application.

Assuming to use three probes, it is convenient to monitor the trigger signal at J17, which usually acts as scope trigger too, the laser current readout and the laser voltage readout. The use of the “Slow” or of the “Fast” readouts depends again on the specific application. Next sections will show the setup for specific measures, but basic probe connection is common to all the reported tests.

5.3 Measuring the Cathode Voltage

The first time a test is set-up, it is worth to monitor the voltage at the cathode side of the output, to prevent possible damage of the board and to get the best performance from the laser and the driver. This step can be dropped once you will be sufficiently confident about the performance of the experimental set-up. A convenient point to measure is the cathode pin of the blue J18 terminal block. For instance, the Figure 37 below shows how to connect a 10 M Ω oscilloscope probe to look at it when a star-board-mounted VCSEL is in use.

Figure 37:
Probe Connection to Cathode Side at J18 Terminal Block⁽¹⁾

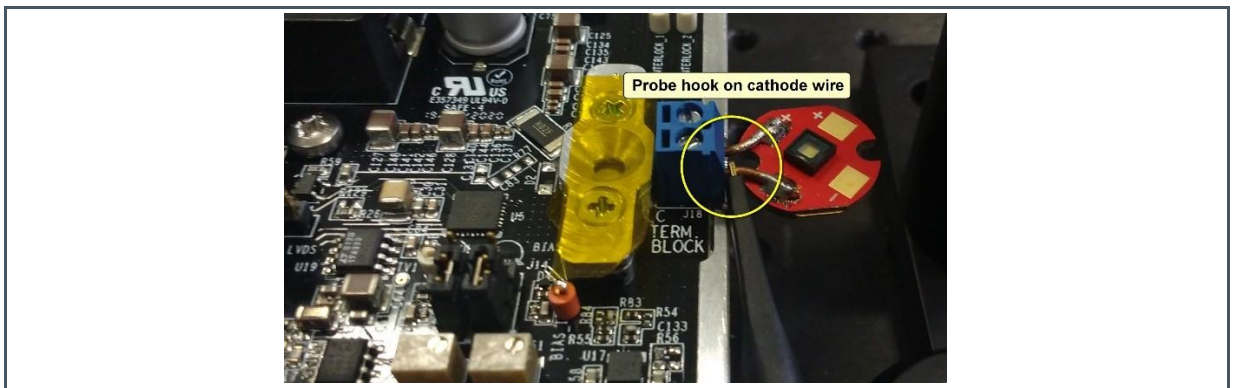

⁽¹⁾ Picture with board with the socket installed but the setup is valid without the socket

Main issues to look for are:

- A voltage in excess of 30 V, usually because of the presence of oscillations and spikes at the end of the laser pulse, can be harmful to the driver electronics.
- Best driver performance in terms of speed requires a cathode voltage always greater than 2 V. Usually, the voltage can drop below this limit when laser is switched on.

Minimizing the stray inductance in the laser connection addresses both these issues. It means to use as short as wires as possible when connecting the laser to the J18 terminal block. Whenever possible, the use of a socket-mounted or welded laser provides the best solution.

The second issue is of course more relevant for applications involving short pulses, like ToF ones. Besides inductance minimization, it can be addressed by adjusting the laser supply voltage (R95, TP4) to a higher value. However, this can rise the danger that cathode voltage spikes exceed the driver rating. The final result will thus be a compromise between switching speed and reliability.

5.4 Taking Confidence Using a Resistive Dummy Load

The use of a resistive dummy load is a convenient way to test the experimental bench and to learn about the possible performance of the driver. A 1 Ω power resistor is included in the driver kit and it can be easily connected to the blue J18 terminal block (Figure 38 below).

Figure 38:
Connecting a Resistive Dummy Load⁽¹⁾

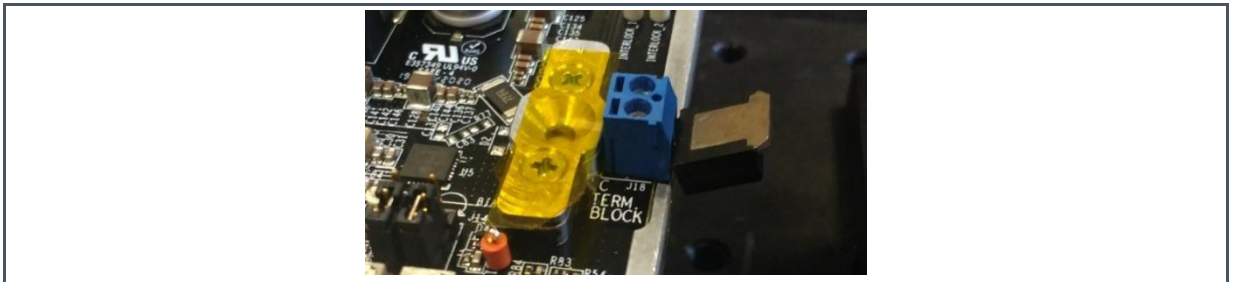

(1) Picture with board with the socket installed but the setup is valid without the socket

Consider bending a little the resistor pins to get the right pitch allowing insertion. Of course, being the stray inductance quite large, just rated as less than 100 nH for this resistor, the performance in terms of speed will be limited.

The Figure 39 below shows the test bench with three 10 M Ω passive scope probes connected. Signals are:

- On Ch1, the internal PWM signal, which acts as acquisition trigger
- On Ch2, the “Slow” current readout at TP15 (purple)
- On Ch4, the “Slow” VCSEL voltage readout at TP14 (green)

Figure 39:
Test Bench for a Resistive Dummy Load⁽¹⁾

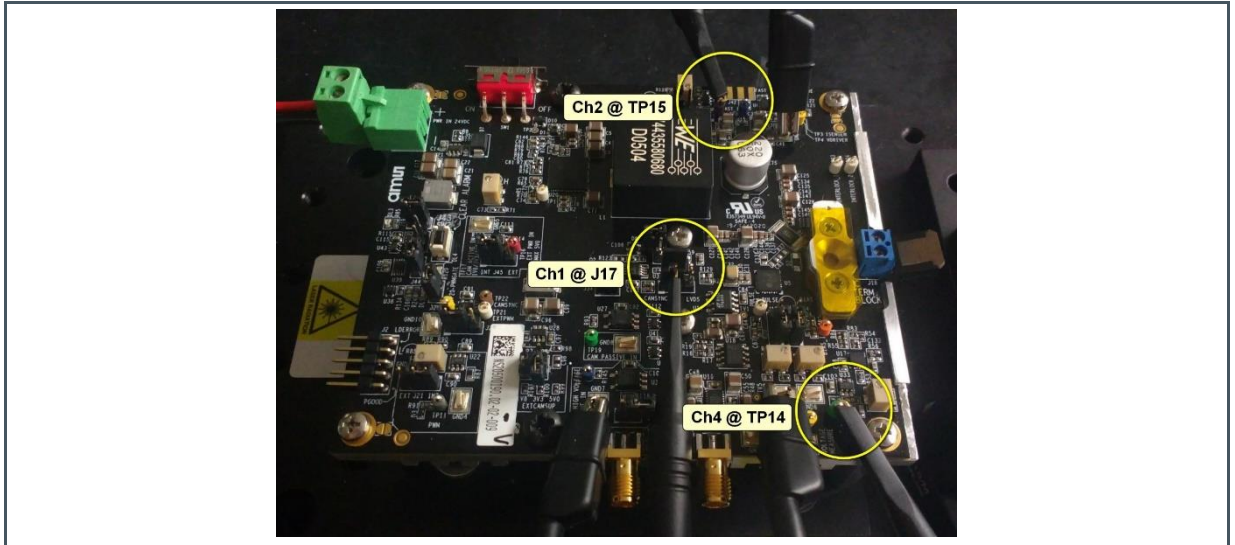

(1) Picture with board with the socket installed but the setup is valid without the socket.

5.4.1 Setting-Up the Measure

- Mount the driver on the test bench
- Connect the external power supply
- Connect the oscilloscope probes (see Figure 39 above)
- Manage the external inputs, if any, as described in previous relevant sections
 - Disable any external strobe or trigger source
 - Connect required cables
- Slide SW1 switch to ON position (Figure 12)
- Set bias and pulsed current to zero, as described above (Figure 14 and nearby)
 - Consider to remove J16 in case you do not need any bias current
- Set the laser supply voltage, as described above (Figure 15 and nearby)
- Minimise the voltage offset at TP14 and TP15, as described above (Figure 19 and nearby)
- Connect the 1 Ω resistive dummy load
- Enable the required strobe or trigger source
- Adjust bias and pulsed current accordingly to the application while monitoring the signals

5.4.2 Acquisition Examples

- Strobe source: on-board PWM oscillator, about 10% duty cycle (pulse length $\sim 1 \mu\text{s}$)
- Laser voltage supply: 6 V, 10 V
- No current bias

- Pulsed current level: 5 A
- Pulsed current readout gain: 100 mV/A (J46 open)
- Scope probes bandwidth: 500 MHz
- Oscilloscope bandwidth: 20 GHz

Oscilloscope and probe bandwidths have no important effects on the acquired signals for this test, although probes add a stray capacitance of about 11 pF that can influence results. Ground connection of the probes can affect the measured waveforms too. Make it using the nearest GND point.

The Figure 40 below shows typical waveforms got in these conditions, being:

- C1 (dark yellow) the strobe signal at J17
- C2 (pale red) the “Slow” current readout at TP15 (purple)
- C3 (blue) the voltage at the “cathode” side of the blue J18 terminal block
- C4 (green) the “Slow” voltage readout at TP14 (green)

Figure 40:
Waveforms Acquired Using a Resistive Dummy Load at 5 A and a 6 V Anode Voltage Supply

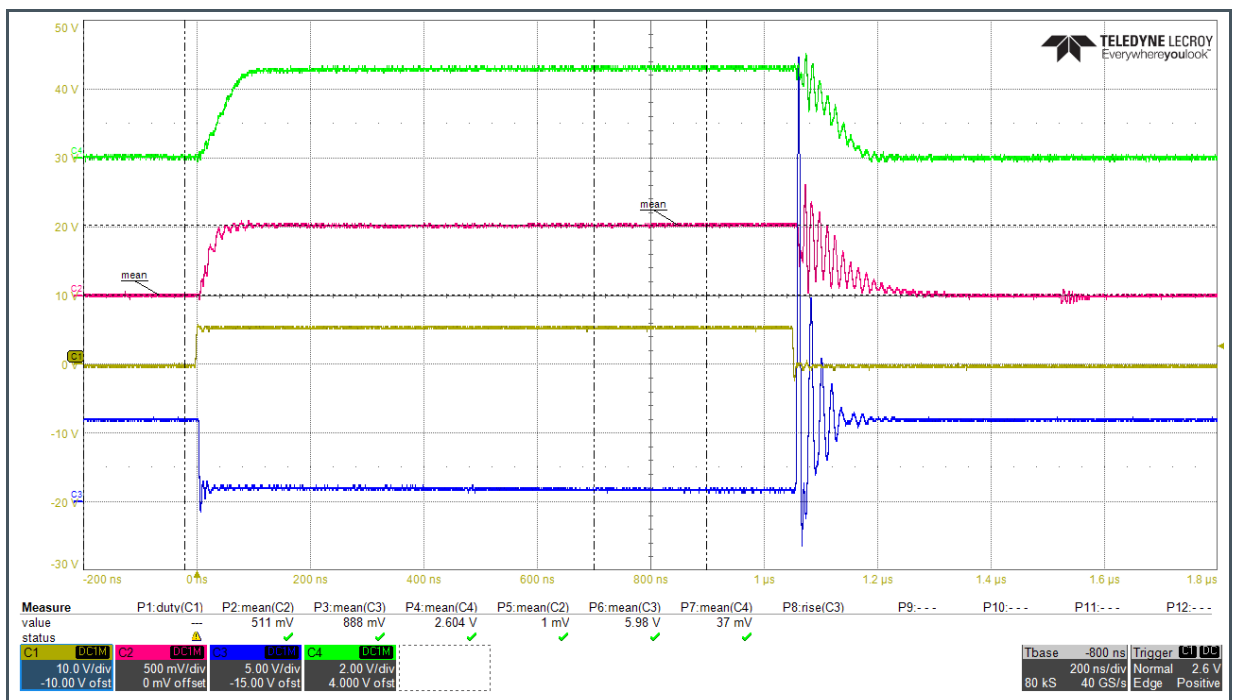

The oscilloscope automatic measuring feature provides information about the waveform amplitudes, as shown in the lower part of the figure. Measure P1 is empty, because a full period of the strobe signal is not present. Next Pn measures refer to the relevant channels and report the waveform average value measured within two specific windows, the first before the beginning of the pulse and the second across the center of the acquisition window. Vertical dash-dot black lines show the limits of these windows. Some aspects are worth to note from the Figure 40 above:

- C2 offset, minimized before the test, is nearly zero (P5 = 1 mV)
- C2 top value (P2 = 511 mV) means a level of the pulsed current of about 5.1 A (100 mV/A)

- C3 value before the pulse (P6=5.98 V) gives the actual setting of the laser supply voltage. The value during the pulse drops to about 0.89 V (P3=888 mV), which is lower than the minimum recommended for the proper operation of the current driver (2 V). However, for rather slow pulses like these are, this is not a real issue. Note that the voltage drop is even larger at the pulse start, where the voltage drops even below zero because of inductive effects.
- Another important aspect of the C3 waveform is the voltage resonance at the pulse end, again related to inductive effects. High amplitude is reached soon after the end of the pulse and, although for a very short time only, this can be higher than the driver maximum voltage rating and reduce its reliability. This is more clearly reported in the Figure 41 below.
- C4 value before the pulse (P7 = 37 mV) gives voltage drop on the dummy load of about 70 mV (not properly nulled before the measure)
- C4 value during the pulse (P4=2.604 V) raises up, giving voltage drop on the dummy load of about 5.2 V, which is in good agreement with the expected 5.1 V taking in account resistor precision and measurement errors, included possible temperature-related changes of the resistance value.

Figure 41:
Highlighting the Voltage Resonance on Cathode Side at the End of the Pulse

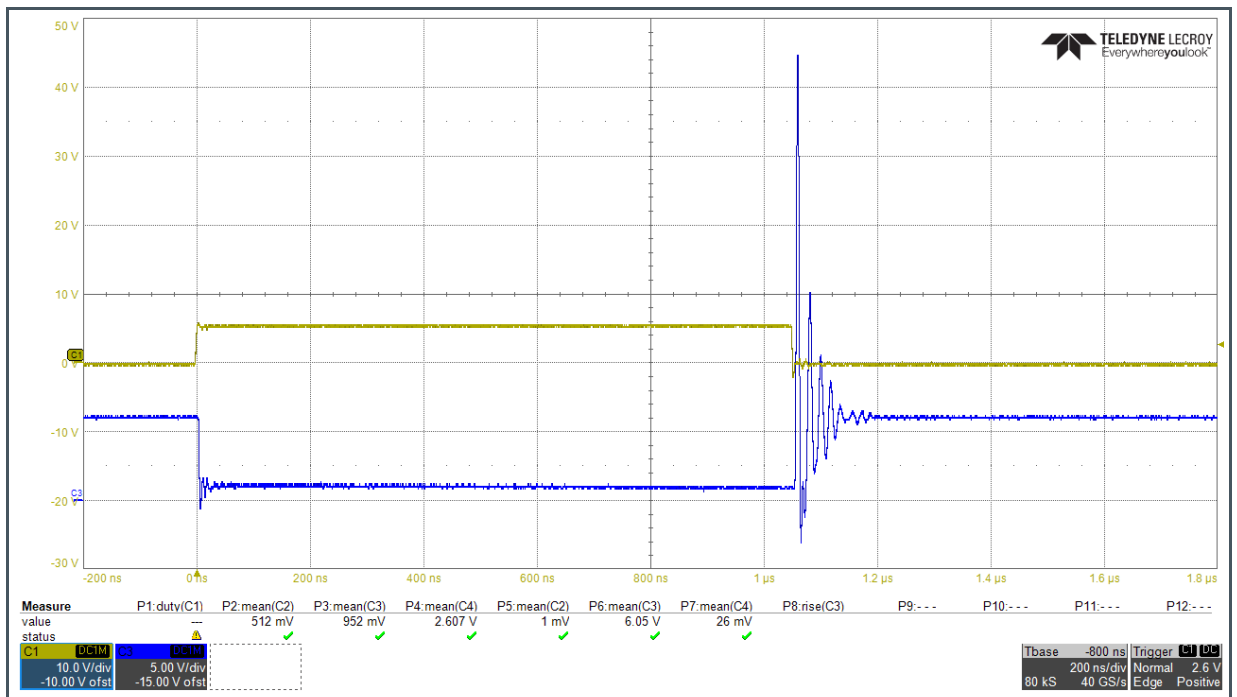

The falling front of C3, the voltage at the cathode side of the terminal block, shows the switching speed capability of the driver. The Figure 42 below reports the fall times measured using a anode voltage supply of 6 V, side (a), and of 10 V, side (b). The 90-10% reduces from about 1.56 ns to 1 ns when switching a 5 A current pulse. However, it is apparent how the pulse undershoot is much larger when using the higher voltage.

Figure 42:
Voltage Fall Time on Cathode Side of J18 Using a Resistive Load

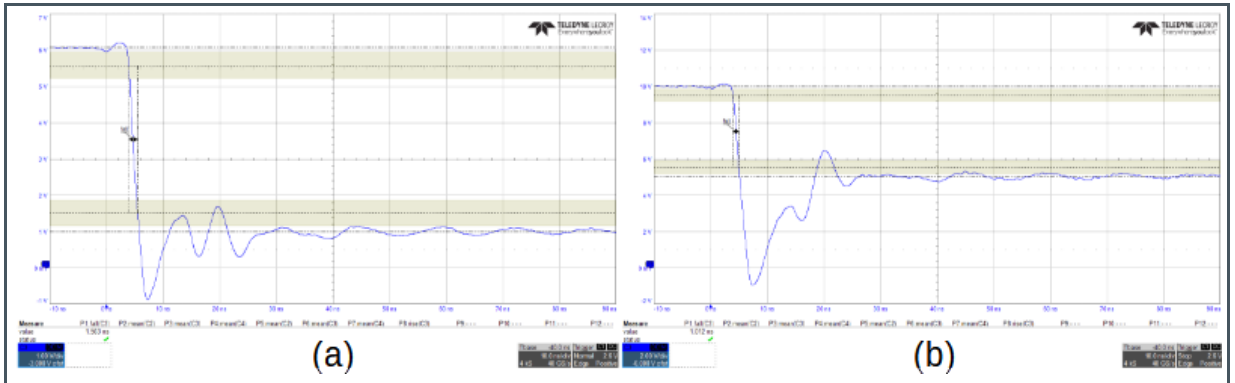

The Figure 43 below shows the waveform acquired when using the anode voltage supply of 10 V. In this case, C3 shows how the cathode side voltage never drops below the minimum 2 V required by the current driver specifications, but for the large drop at the pulse begin.

Figure 43:
Waveforms Acquired using a Resistive Load at 5 A and a 10 V Anode Voltage Supply

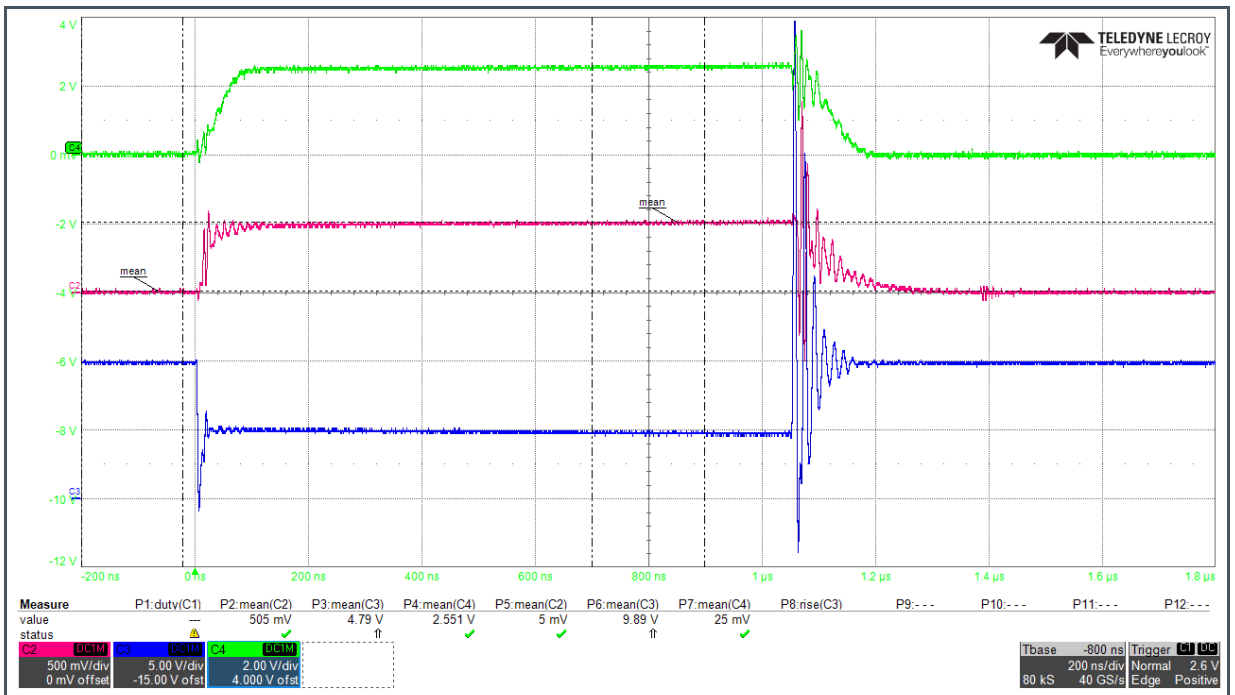

5.5 Measuring a Starboard-Mounted Laser with 1 μ s Pulse Length

The Figure 44 below shows the set-up of the test bench for a starboard-mounted TARA2000-AUT / EGA2000. The connection of the laser is the “shortest possible” already reported above. The trigger source for this test is the on-board PWM oscillator. Most considerations are similar to what already told for the previous test, but repeated for convenience.

As for the resistive load test, three 10 M Ω passive probes connect to three meaningful electrical signals, while a fast photodiode connects directly to the fourth channel with a 50 Ω coaxial cable. The photodiode signal is now present instead of the cathode voltage.

Thus, the acquired signals are:

- On Ch1, the internal PWM signal, which acts as acquisition trigger
- On Ch2, the “Slow” current readout at TP15 (purple)
- On Ch3, the optical pulse as detected by a fast photodiode
- On Ch4, the “Slow” VCSEL voltage readout at TP14 (green)

Figure 44:
The Test Bench for a TARA2000-AUT / EGA2000 Mounted on Starboard⁽¹⁾

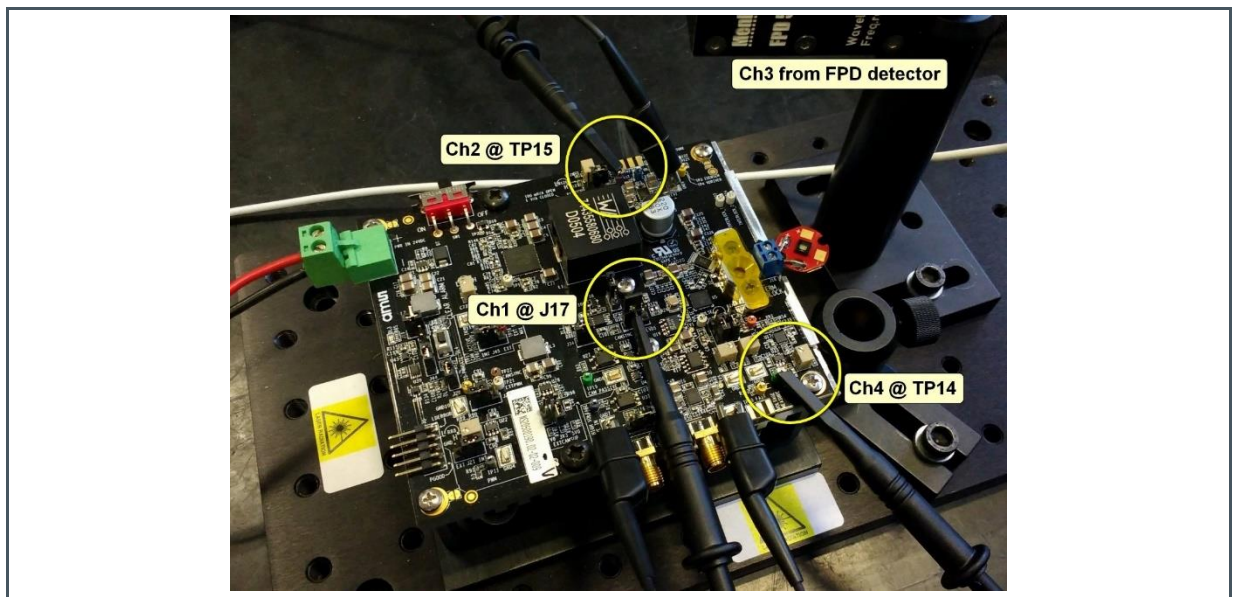

⁽¹⁾ Picture with board with the socket installed but the setup is valid without the socket

5.5.1 Setting-Up the Measure

- Mount the driver on the test bench
- Connect the external power supply
- Connect the oscilloscope probes (see Figure 44 above)

- Manage the external inputs, if any, as described in previous relevant sections
 - Disable any external strobe or trigger source
 - Connect required cables
- Slide SW1 switch to ON position (Figure 12)
- Set bias and pulsed current to zero, as described above (Figure 14 and nearby)
- Consider to remove J16 in case you do not need any bias current
- Set the laser supply voltage, as described above (Figure 15 and nearby)
- Minimize the voltage offset at TP14 and TP15, as described above (Figure 15 and nearby)
- Enable the required strobe or trigger source
- Adjust bias and pulsed current accordingly to the application while monitoring the signals

5.5.2 Acquisition Examples

- Strobe source: on-board PWM oscillator, about 10% duty cycle (pulse length $\sim 1 \mu\text{s}$)
- Laser voltage supply: 9 V
- No current bias
- Pulsed current level: 10 A
- Pulsed current readout gain: 100 mV/A (J46 open)
- Scope probes bandwidth: 500 MHz
- Oscilloscope bandwidth: 20 GHz
- Photodiode bandwidth: 200 MHz or 5 GHz, depending of test

Oscilloscope and probe bandwidths have no important effects on the acquired signals for this test. Probes add a stray capacitance of about 11 pF that can influence results, but larger capacitance is likely related to the PN junction of the laser, especially in forward bias. Ground connection of the probes can affect the measured waveforms too. Make it using the GND point nearest to the probe.

The Figure 45 below shows typical waveforms got in these conditions, being:

- C1 (dark yellow) the strobe signal at J17
- C2 (pale red) the “Slow” current readout at TP15 (purple)
- C3 (blue) the photodiode signal, i.e., the optical output
- C4 (green) the “Slow” voltage readout at TP14 (green)

Figure 45:
Short Wires Starboard-Mounted Module – Typical Waveforms (“Slow” Readouts)

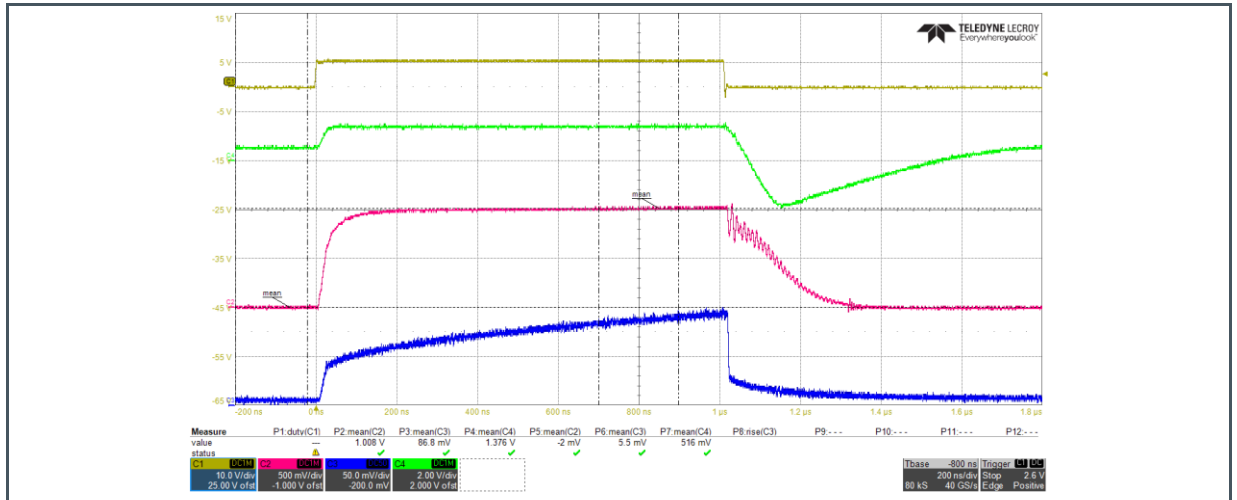

The oscilloscope automatic measuring feature provides information about the waveform amplitudes, as shown in the lower part of the figure. Measure P1 is empty, because a full period of the strobe signal is not present. Next Pn measures refer to the relevant channels and report the waveform average value measured within two specific windows, the first before the beginning of the pulse and the second across the center of the acquisition window. Vertical dash-dot black lines show the limits of these windows. Some aspects are worth to note from the Figure 45 above:

- C2 offset, minimized before the test, is nearly zero (P5 = -2 mV)
- C2 top value is about 1V (P2 = 1.008), which is consistent to the set level of the pulsed current of 10 A (expected $10\text{ A} \cdot 100\text{ mV/A} = 1\text{ V}$)
- C4 value before the pulse (P7 = 516 mV) gives an anode-cathode drop of about 1V, being the readout gain 500 mV/V. This drop figure is usual for TARA2000-AUT or EGA2000 lasers, considering that, for measuring purposes, the driver electronics let anyway flow a tiny rest current in the laser, about 10 mA in this case.
- C4 value during the pulse (P4=1.376 V) raises up, giving an anode-cathode drop of about 2.75 V, which is also a typical for TARA2000-AUT at this current level.
- C3 shows an optical response clearly characterized by different phases. At pulse start there is a quite fast rise of the emitted power, but a much slower increase follows. Because the current is constant during the slow increase phase, this is likely related to laser dynamics. Similarly, at the pulse end, the optical power drops quickly, but a rather long tail follows. In this case some laser dynamics effect can be present too, but the real current behavior needs some more investigation, as below reported.

The relatively low bandwidth of both C2 and C4 clearly contributes to their slow response at the pulse start. The much slower response at the pulse end is instead partly related to a real slower decay of the current. What is not visible here are the fast transients related to current switching. So:

- Move probe C2 to the “Fast” TP8 (blue) current readout
- Move probe C4 to the “Fast” TP10 (yellow) voltage readout

We can have now some more insight from the Figure 46 below. The 20 MHz bandwidth oscilloscope filter is active to clean the C2 and C4 waveforms, which would be much noisier without it. The filter does not hide the most important outcomes from these measures, considering it puts a rise/fall time limit of about 20 ns only.

Figure 46:
Short Wires Starboard-Mounted Modules – Typical Waveforms (“Fast” Readouts)

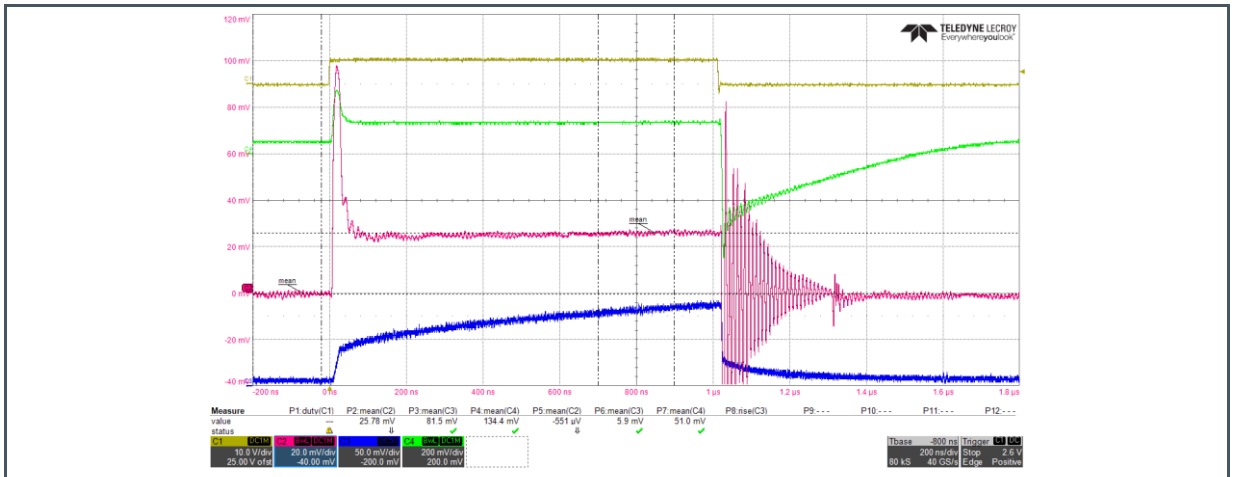

From these waveforms we see that:

- C2 readout is consistent with the previous one, giving zero current before the pulse and about 10.3 A at the flat top (P2 = 25.78 mV with 2.5 mV/A gain)
- C4 readout is consistent too, with a pre-pulse level of about 1V (P7 = 51 mV with 50 mV/V gain) and a flat-top one of 2.67 V (P4 = 134.4 mV)
- At pulse start an overshoot is present for both the laser current C2 and the anode-cathode voltage C4. The overshoot duration looks related to the first steeper rise of the optical power.
- At pulse end, a strong resonant oscillation is present on the current readout, due to the fast switch-off of the current. Frequency, amplitude and decay time depend on circuit inductance, capacitance and resistance.

At this stage, it is worth to have a look at the cathode voltage. Move the C4 probe and connect it to the cathode wire as shown in the Figure 37. We get the result on the Figure 47, which does not display the trigger signal to ease the view of C4. We get that:

- C4 value before the pulse is about 8.5 V (P4), which is rather consistent with the previous measures, although something around 8V were expected.
- C4 value during the “flat” part is 6.54 V (P4), which is consistent with previous measures
- A first important issue is that C4 shows a large drop to nearly ground at the pulse start, which is due to the inductive voltage drop caused by the fast switch-on of the current in the laser circuit. Because the IC-HG30 current source needs a 2 V minimum voltage to operate properly, this initial drop can badly affect the driver performance. A possible solution to mitigate the effect is the use of a larger laser supply voltage, so to have room to accommodate the inductive voltage drop. A first major drawback is of course an increase in power dissipation.

- A second important issue is the presence of a large resonant oscillation on the cathode voltage, not surprisingly similar to what already observed on the laser current. In this case, the critical aspect is that at the oscillation begin the voltage is quite large and possibly larger than the maximum rating of the driver current source, although for a very short time. To prevent possible reliability problems, the only solution is to minimize the circuit inductance and, of course, reduce the operating current level. Note that any increase of the laser voltage supply level, which helps about the initial voltage drop, can be instead detrimental about this second issue.

Figure 47:
Short Wires Starboard-Mounted Module – Watching to Cathode Voltage

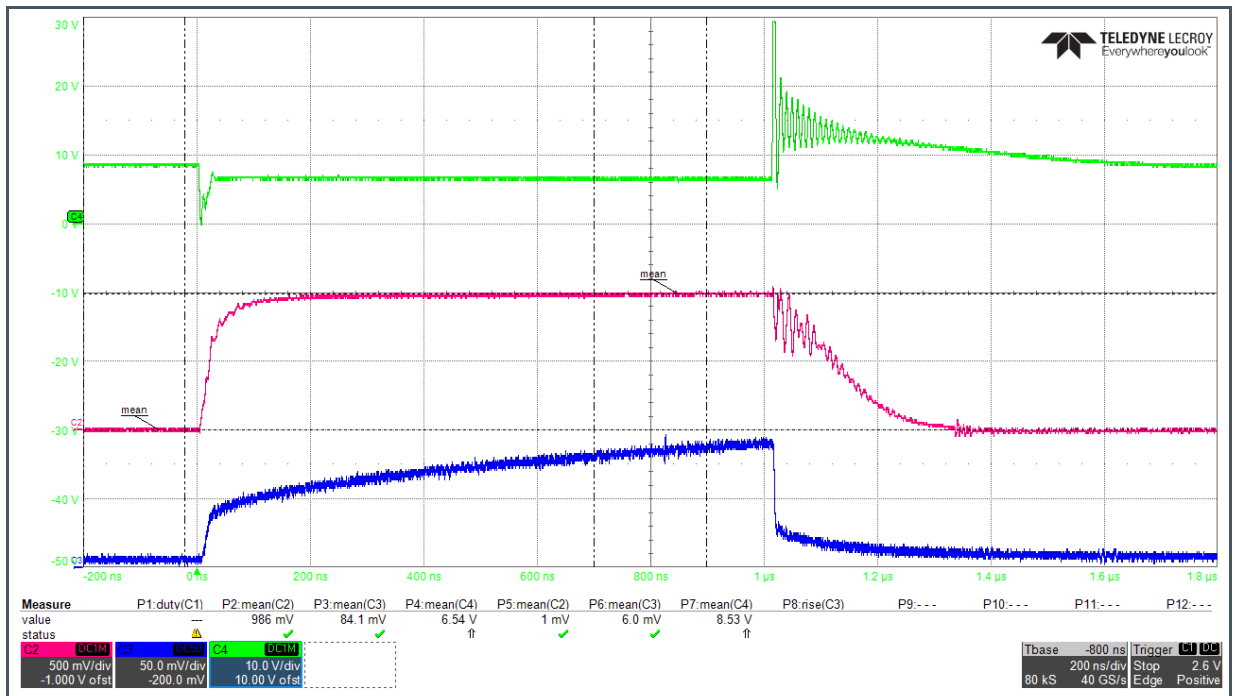

Further insight comes from using a very fast photodiode to look at the very beginning of the optical pulse. The Figure 48 below shows the waveforms obtained at 9 V, 12 V and 15 V. The C4 trace shows the cathode voltage and it comes out that the minimum value increases only a little with the laser supply voltage V_L . This is because the faster the switching becomes, the larger is the inductive voltage drop. However, the rise time of the initial part of the pulse largely benefits of the increasing supply voltage, as apparent from part (d) of the figure with overlapped traces. The rise time decreases from about 15 ns at 9 V down to about 10 ns at 12 V and finally to about 8 ns at 15 V.

The improvement in speed is less effective while the laser voltage increases, as shown on the Figure 49. The optimal operating value has to take in account that thermal load increases with the laser supply voltage. The overall board consumption for this test increases by about 50% from 9 V to 15 V and the rise time decreases correspondingly by a similar proportion. However, the rate of rise time reduction is more favorable rising the laser voltage to 12 V only, which gives a 24% increase in consumption but a 34% decrease in the rise time. Of course, this trade-off strongly depends on the specific application.

Finally, from the obtained results it is apparent that with this setup the laser can switch with pulse lengths in the order of some tens of nanosecond, but at the expense of the optical output power. In fact, it takes more than 1 μ s to reach the maximum of the optical power corresponding to the used pumping current. In other words, given the current level, the pulsed optical power is lower than expected on the basis of long pulse or quasi-CW measures.

Figure 48:
Short Wires Starboard-Mounted Mounted – Optical Rise Time at Different Anode Voltage

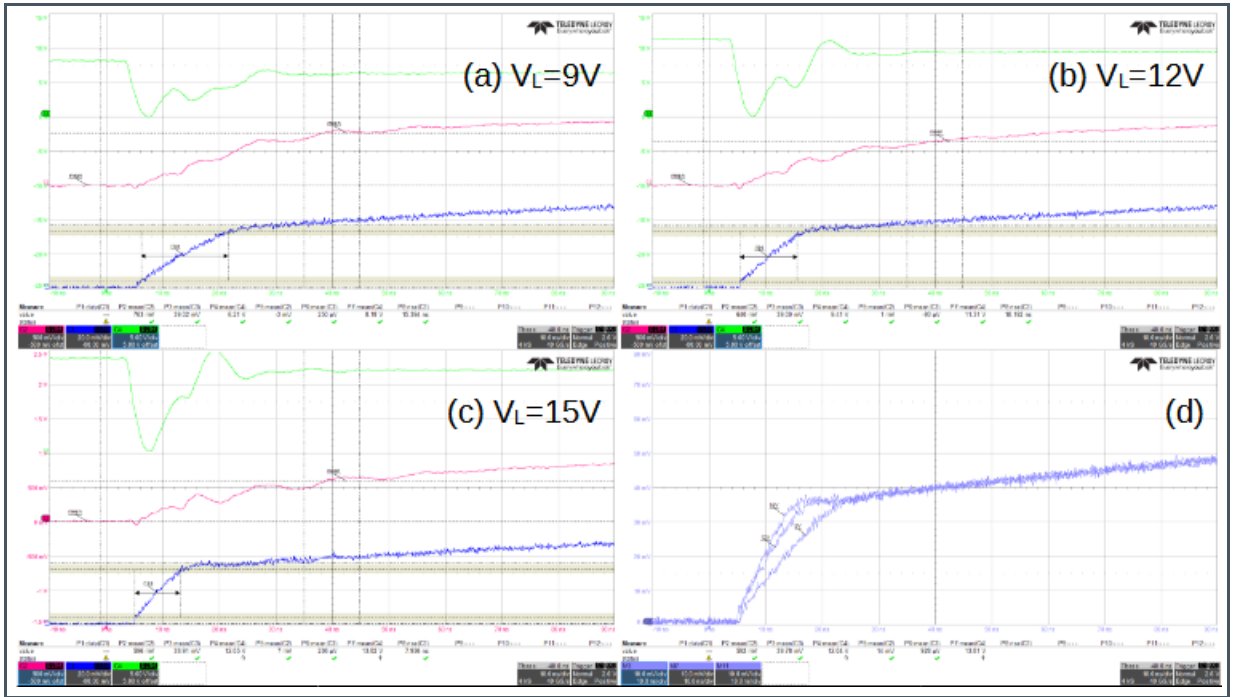

Figure 49:
Consumption vs Laser Supply

Vlaser [V]	Rise [ns]	P@24V [W]	dRT/RT	dP/P
9	15.4	13	---	---
12	10.2	16	-34%	24%
15	7.9	19	-22%	18%

5.6 Measuring a Socket-Mounted (or Soldered) Laser with 1 μ s Pulse Length

The Figure 50 below shows the set-up of the test bench for a socket-mounted TARA2000-AUT / EGA2000. The trigger source for this test is the on-board PWM oscillator. Most considerations are similar to what already told for the previous tests, but repeated for convenience.

As for the star-board mounted test, three 10 M Ω passive probes connect to three meaningful electrical signals, while a fast photodiode connects directly to the fourth channel with a 50 Ω coaxial cable. Thus, acquired signals are:

- On Ch1, the internal PWM signal, which acts as acquisition trigger
- On Ch2, the “Slow” current readout at TP15 (purple)
- On Ch3, the optical pulse as detected by a fast photodiode
- On Ch4, the “Slow” VCSEL voltage readout at TP14 (green)

Figure 50:
The Test Bench for a TARA2000-AUT / EGA2000 Mounted on the Socket⁽¹⁾

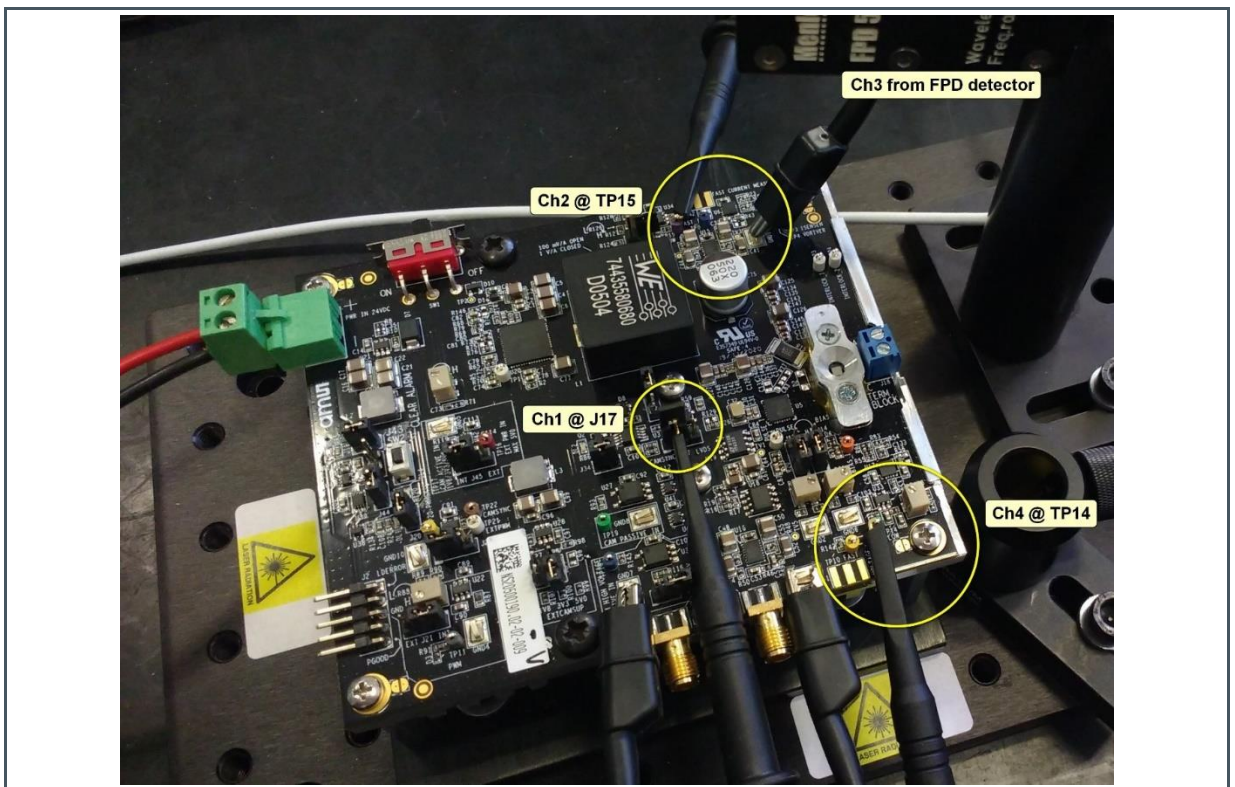

(1) Picture with board with the socket installed but the setup is valid without the socket

5.6.1 Setting-Up the Measure

- Mount the driver on the test bench
- Connect the external power supply
- Connect the oscilloscope probes (see Figure 50 above)
- Manage the external inputs, if any, as described in previous relevant sections
 - Disable any external strobe or trigger source
 - Connect required cables
- Slide SW1 switch to ON position (Figure 12)
- Set bias and pulsed current to zero, as described above (Figure 14 and nearby)
 - Consider to remove J16 in case you do not need any bias current
- Set the laser supply voltage, as described above (Figure 15 and nearby)
- Minimize the voltage offset at TP14 and TP15, as described above (Figure 19 and nearby)
- Enable the required strobe or trigger source
- Adjust bias and pulsed current accordingly to the application while monitoring the signals

5.6.2 Acquisition Examples

- Strobe source: on-board PWM oscillator, about 10% duty cycle (pulse length $\sim 1\ \mu\text{s}$)
- Laser voltage supply: 9 V
- No current bias
- Pulsed current level: 10 A
- Pulsed current readout gain: 100 mV/A (J46 open)
- Scope probes bandwidth: 500 MHz
- Oscilloscope bandwidth: 20 GHz
- Photodiode bandwidth: 200 MHz or 5 GHz, depending of test

Oscilloscope and probe bandwidths can have some effect on the acquired signals for this test, being the waveforms faster. Consider the bandwidth of all the involved devices when evaluating the speed of response. As for previous tests, the probes add a stray capacitance of about 11 pF that can influence results, but larger capacitance is likely related to the PN junction of the laser, especially in forward bias. Ground connection of the probes can affect the measured waveforms too. Make it using the GND point nearest to the probe.

The Figure 51 below shows the waveforms of the main signals, being:

- C1 (dark yellow) the strobe signal at J17
- C2 (pale red) the “Slow” current readout at TP15 (purple)
- C3 (blue) the photodiode signal, i.e., the optical output
- C4 (green) the “Slow” voltage readout at TP14 (green)

Figure 51:
Socket-Mounted (or Soldered) Module – Typical Waveforms (“Slow” Readouts)

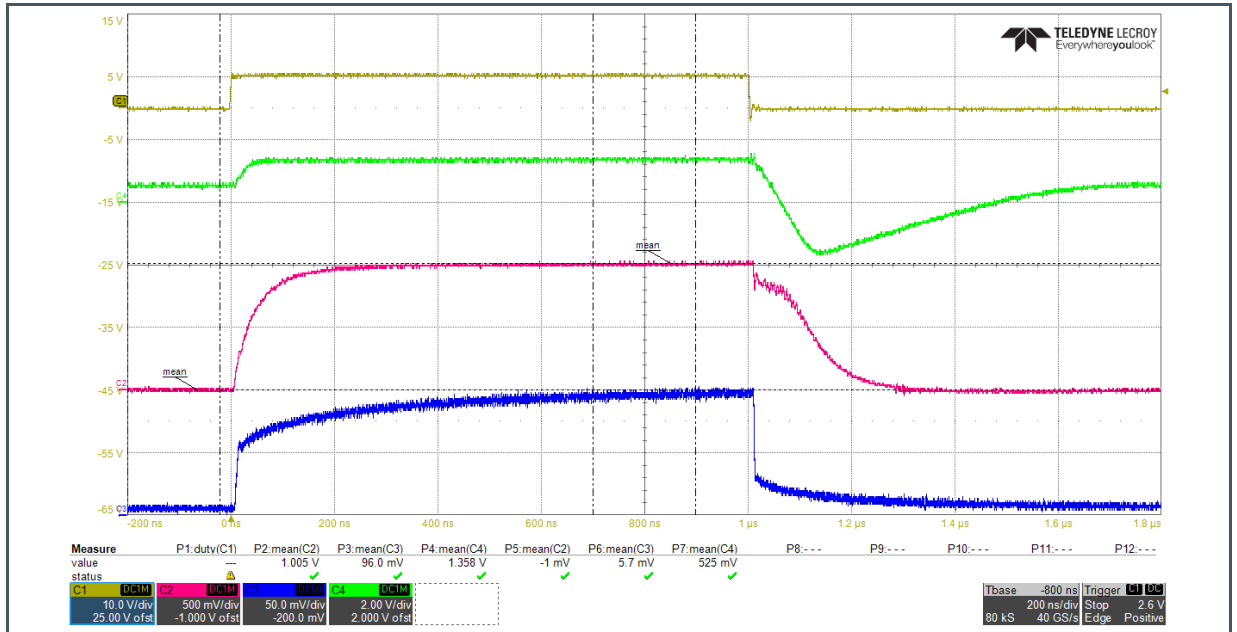

The oscilloscope automatic measuring feature provides information about the waveform amplitudes, as shown in the lower part of the figure. Measure P1 is empty, because a full period of the strobe signal is not present. Next Pn measures refer to the relevant channels and report the waveform average value measured within two specific windows, the first before the beginning of the pulse and the second across the center of the acquisition window. Vertical dash-dot black lines show the limits of these windows. Some aspects worth to note from the Figure 45:

- C2 offset, minimized before the test, is nearly zero (P5 = -1 mV)
- C2 top value is about 1 V (P2 = 1.005), which is consistent to the set level of the pulsed current of 10 A (expected $10 \text{ A} * 100 \text{ mV/A} = 1 \text{ V}$)
- C4 value before the pulse (P7 = 525 mV) gives an anode-cathode drop of about 1V, being the readout gain 500 mV/V. This drop figure is usual for TARA / EGA lasers, considering that, for measuring purposes, the driver electronics let anyway flow a tiny rest current in the laser, about 10 mA in this case.
- C4 value during the pulse (P4=1.358 V) raises up, giving an anode-cathode drop of about 2.72 V, which is again typical for TARA2000-AUT / EGA2000 at this current level.
- C3 shows an optical response clearly characterized by different phases, as already seen for the star-board-mounted device. At pulse start there is a fast rise of the emitted power, but a slower further increase follows. Because the current is constant during the slow increase phase, this is likely related to laser dynamics. Similarly, at the pulse end, the optical power drops quickly, but a rather long tail follows. In this case some laser dynamics effect can be present too, but the current behavior is further investigated below.
- Comparing this C3 response with Figure 45, obtained using the star-board-mounted laser, it is apparent that it is quite faster:
 - The initial part is much steeper and reaches a higher fraction of the final value
 - The second and slower part is anyway faster, so that the pulse reaches a flat top

- At the pulse end, the first falling part is somewhat faster too, while the tail is quite similar

As in previous tests, the relatively low bandwidth of both C2 and C4 clearly contributes to their slow response at the pulse start. The much slower response at the pulse end is instead partly related to a real slower decay of the current. What is not visible here are the fast transients related to current switching. So:

- Move probe C2 to the “Fast” TP8 (blue) current readout
- Move probe C4 to the “Fast” TP10 (yellow) voltage readout

We can now have some more insight from the Figure 52 below. The 20 MHz bandwidth oscilloscope filter is active to clean the C2 and C4 waveforms, which would be much noisier without it. The filter does not hide the most important outcomes from these measures, considering it puts a rise/fall time limit of about 20 ns only.

Figure 52:
Socket-Mounted (or Soldered) – Typical Waveforms (“Fast” Readouts)

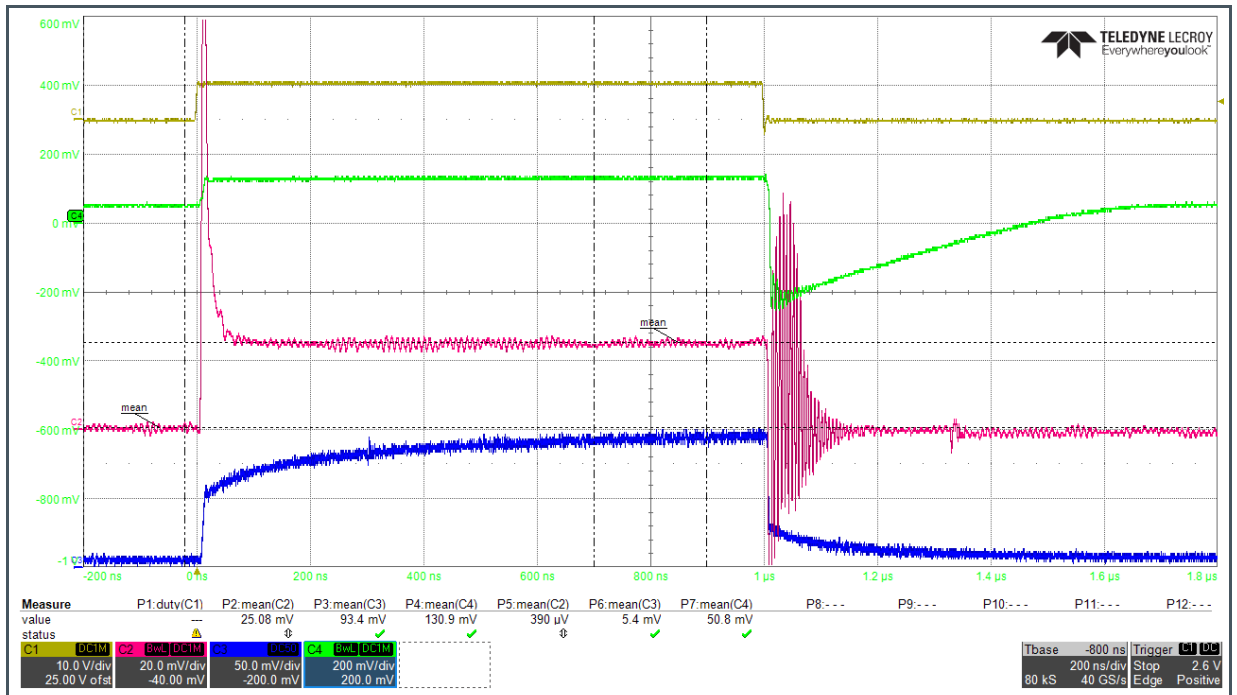

From these waveforms we see that:

- C2 readout is consistent with the previous one, giving zero current before the pulse and about 10 A at the flat top (P2 = 25.08 mV with 2.5 mV/A gain)
- C4 readout is consistent too, with a pre-pulse level of about 1 V (P7 = 50.8 mV with 50 mV/V gain) and a flat-top one of 2.62 V (P4 = 130.9 mV)
- At pulse start an overshoot is present for both the laser current C2 and the anode-cathode voltage C4. The overshoot duration looks related to the first steeper rise of the optical power, as it was for the socket-mounted laser.

- At pulse end, a strong resonant oscillation is present on the current readout, due to the fast switch-off of the current. As told before, frequency, amplitude and decay time depend on circuit parasitic parts. Compared to Figure 46, the decay is faster and the maximum amplitude smaller, which indicate a less amount of stray inductance and capacitance.

At this stage, as for the star-board-mounted device, it is worth to have a look at the cathode voltage. In this case, the best way to go is to move the C4 probe and connect it to a wire inserted in the blue J18 terminal block (see Figure 53).

Figure 53:
Connecting to J18 Cathode⁽¹⁾

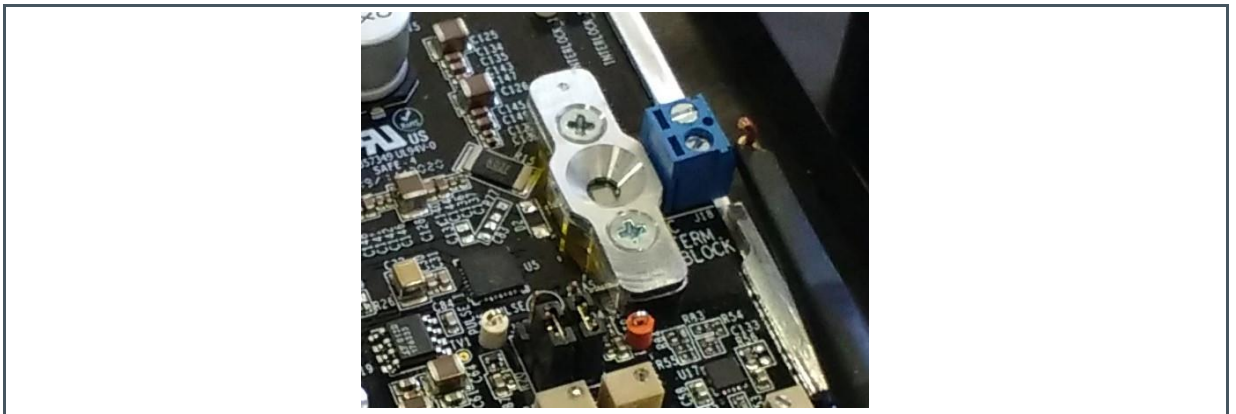

(1) Picture with board with the socket installed but the setup is valid without the socket

The Figure 54 below shows the acquired waveforms, but without the C1 trigger signal to ease the view of C4.

We get that:

- C4 value before the pulse is about 8.5 V (P4), which is rather consistent with the previous measures, although something around 8 V were expected.
- C4 value during the “flat” part is 6.51 V (P4), which is consistent with previous measures
- The first important issue is that C4 shows a large drop to nearly ground at the pulse start, which is due to the inductive voltage drop caused by the fast switch-on of the current in the laser circuit. Because the IC-HG30 current source needs a 2 V minimum voltage to operate properly, this initial drop can badly affect the driver performance. A possible solution to mitigate the effect is the use of a larger laser supply voltage, so to have room to accommodate the inductive voltage drop. A first major drawback is of course an increase in power dissipation.
- A second important issue is the presence of a resonant oscillation on the cathode voltage, not surprisingly similar to what already observed on the laser current. In this case, the critical aspect is that at the oscillation begin the voltage can be larger than the maximum rating of the driver current source, although for a very short time. To prevent possible reliability problems, the only solution is to minimize the circuit inductance and, of course, reduce the operating current level. Note that any increase of the laser voltage supply level, which helps about the initial voltage drop, can be instead detrimental about this second issue.

- With respect to the star-board-mounted device we notice:
 - The initial cathode voltage drop is lower. It allows for a better operation of the driver and ultimately gives a faster response.
 - The oscillation at the end of the pulse is less evident, decays faster, as already seen about the current, and its maximum value is somewhat lower too. As told about the current resonance, this indicates that parasitic inductance and capacitance are much lower in this case.

Figure 54:
Socket-Mounted (or Soldered) Modules – Watching to Cathode Voltage

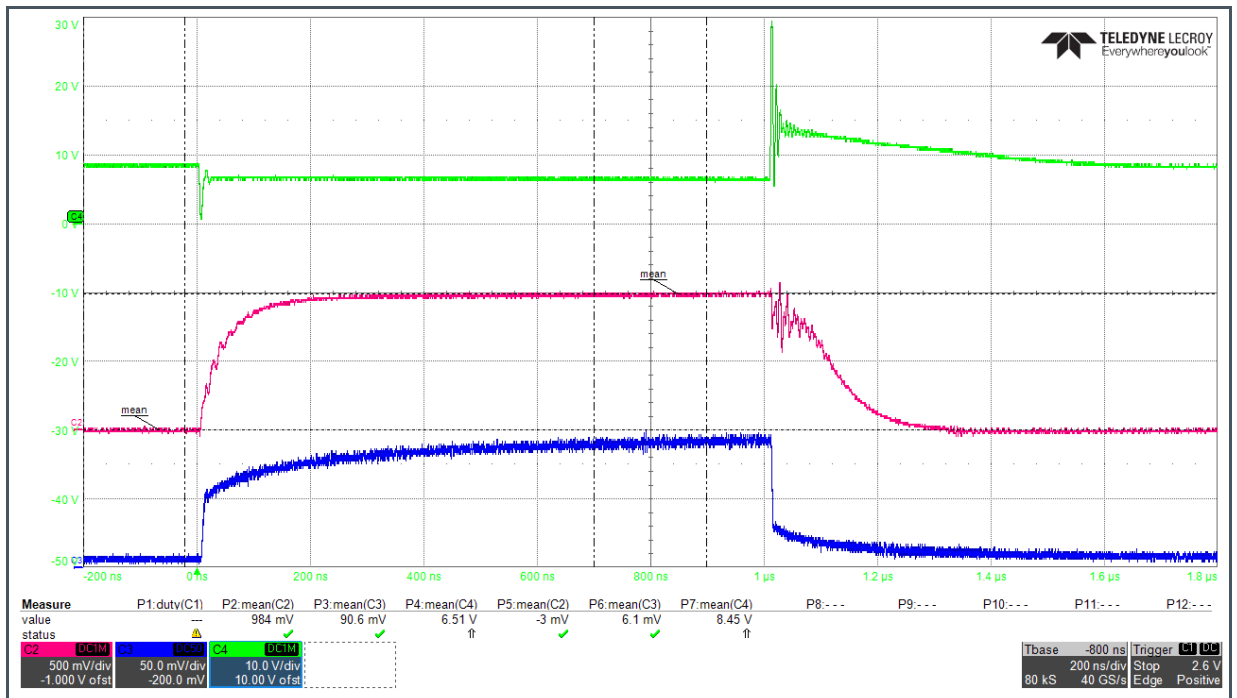

6 Troubleshooting

6.1 Red LED DL1 is ON: Driver Fault

The source of any alarm is the IC-HG30 driver, which can assert both permanent and temporary failure conditions. The lighting of the red DL1 LED signals the presence of an IC-HG30 fault. The most common problem is overheating, which triggers a board-level alarm too (see next section). The device shuts down and quickly cools down, ending the error condition. In this case, DL1 only flashes shortly and then stay off.

In case a permanent lighting of DL1 is present, the problem requires board maintenance by trained personnel. Ask the manufacturer about this.

6.2 Yellow LED DL4 is ON: Board-Level Error

The yellow DL4 LED lighting signals the presence of a board-level alarm condition, which origins from a fault condition asserted by the IC-HG30 driver.

In case both DL4 and DL1 are stably on, the problem requires board maintenance by trained personnel. Ask the manufacturer about this.

In case DL1 is off, the most common reason for being DL4 on is over-heating. The IC-HG30 driver set a temporary failure condition after its internal temperature had raised above 130°C, but the automatic shutdown already allowed the temperature to reach a safe lower value. For safety, the alarm has been latched and needs a reset action.

It is recommended to remove input trigger before going on and to think about the origin of the overheating condition. Two ways exist to go on:

- Push briefly the SW2 push button
- Use an external control that shorts the J43 pin for a while using a clean contact
 - A so-called “clean contact” is a simple mechanical switch or an electronic device that does not apply any voltage to the circuit. For instance, it can be the drain of a MOS transistor with its source grounded.

After reset assertion, DL4 switches off and the board resumes to operate immediately, depending on the presence or not of input trigger or strobe signals.



Board operation resumes soon after reset.

Consider trigger removal before resetting.

6.3 No Current: Check Electrical Integrity of Output

In case no output current is present, first check:

- Green DL3 power-on LED lights
- Blue DL2 trigger LED lights
- Yellow DL4 board alarm LED is off
- Red DL1 IC-HG30 faoul LED is off
- In case DL1 or DL4 are on, see previous sections

A simple verification of the electrical integrity of the board is to measure the resistance between the anode and cathode connection points and from them to ground too. The measure has to be performed using an electronic multimeter, with the board switched off and without any laser mounted. Because polarity matters, repeat twice the measure for each couple of terminals reversing it from one to the other. The screws of the blue J8 terminal block are convenient points to be used for this test. The Figure 55 reports the typical resistance ranges expected.

Consider that each different multimeter can give different results and have its own response time, depending on the actual current the instrument injects to take the measure. This test looks for a fault condition, actually a short or an open circuit, which has not to be found, while the listed normal resistance ranges are for reference only. The measured resistance is usually independent on the connection polarity, but some variation could occur for the Anode-to-GND one depending on the instrument used.

Figure 55:
Typical Resistance Measured Across Laser Connection Points and to Ground

		The positive probe of ohm-meter is connected to:		
		Cathode	Anode	Ground
The other to	Cathode	--	1900-2100 Ω	1350-1500 Ω
	Anode	1900-2100 Ω	--	300-600 Ω
	Ground	1350-1500 Ω	300-600 Ω	--

6.4 Sudden Board-Level Error While Using LVDS

When the LVDS mode is in use, a board-level error can rise soon after the board switch-on. The most likely cause of this is a sudden over-heating of the driver.

- In the rather common case, the emission is in burst of 50% duty cycle pulses separated by some rest time, check that the voltage level applied at the inputs between one burst and another is such to keep the laser off. Some arbitrary waveforms generators can have issues when used to emulate bursts of LVDS signals
- In case your input is a continuous waveform, check that the power dissipation is within limits considering the current level and the waveform duty cycle

7 Annex

7.1 Board Settings Configurations

The Figure 56 below lists the on-board jumpers that allow to set different configurations. The yellow highlighted sections are the factory configuration.

Figure 56:
Board Configurations

Label	Description	Close to Select	
J12	Select internal/external source for pulsed current setting	1-2 Internal	2-3 External
J14	Select internal/external source for bias current setting	1-2 Internal	2-3 External
J16	Enable bias current source	1-2 Enabled	Open Disabled
J17	Select LVDS trigger or Camera Master strobe	1-2 Camera Master	2-3 LVDS
J19	Enable DL3 LED lighting: Board is powered ON	Closed LED enabled	Open LED disabled
J20	Enable DL1 LED lighting: Driver alarm	Closed LED enabled	Open LED disabled
J21	Select PWM duty cycle control internal/external	1-2 Internal	2-3 External
J26	Configure the on-board supply for the Camera Master interface at logic levels (1V8, 3V3 or 5 V)	5V	3V3 1V8
J27		J26 Open	Closed Open
		J27 Open	Open Closed
J28	Enable AND logic between external strobe and on-board PWM	1-2 PWM enabled	2-3 PWM disabled
J34	Enable DL2 LED lighting: Laser is ON	Closed LED enabled	Open LED disabled
J36	Configure the input range for the Camera Master interface at industrial levels (12 V or 24 V)	1-2 12V input	Open 24V input
J45	Select internal/external voltage supply for the Camera Master interface at logic levels	1-2 Internal	2-3 External
J44	Enable DL4 LED lighting: Board disabled alarm	Closed LED enabled	Open LED disabled
J46	Gain for "Slow" current measure at TP15 (purple)	Closed 1 V/A	Open 100 mV/A

7.2 External Connections

The Figure 57 below lists the board input and output connections. Several ground-loops, sequentially numbered with a prefix “GND”, are located in different positions on the board to ease ground connection of any external equipment.

Figure 57:
Illuminator Evaluation Kit Board Connectors

Label	Function	Description
J1 (green socket)	Power Supply	Supply input, nominal 24 V (± 2 V range)
J2 (black header)	Board Status	Logic levels reporting board status (see Figure 39)
J5 (SMA)	LVDS+ trigger	Differential trigger input with LVDS logic levels
J7 (SMA)	LVDS- trigger	
J18 (blue)	VCSEL terminal	Terminal block for wired VCSEL connection
J43 (black header)	Reset of board alarm	Input to reset board fault (use clean contact to GND)
LD1	VCSEL pads	Pads for laser soldering or socket mounting
TP3 (brown)	Current sensing low side (negative)	Negative side of current sensing resistor
TP4 (yellow)	Current sensing high side (positive) V_{driver} test point	Positive side of current sensing resistor, directly connected to V_{driver} supply
TP6 (white)	Pulse current level	External 0-5 V voltage to set pulsed current level
TP7 (orange)	Bias current level	External 0-3 V voltage to set bias current level
TP8 (blue)	Laser current “Fast”	readout of laser current 300 MHz bandwidth 2.5 mV/A gain
TP10 (yellow)	Laser voltage “Fast”	Readout of Anode-Cathode voltage, wide bandwidth 450 MHz bandwidth 50 mV/V gain
TP11 (grey)	PWM duty cycle external control	0–1 V voltage input to set PWM duty cycle
TP14 (green)	Laser voltage “Slow”	Readout of Anode-Cathode voltage, low-pass filtered 10 MHz bandwidth 500 mV/V gain
TP15 (purple)	Laser current “Slow” (J46 open)	Readout of laser current, low-pass filtered 2 MHz bandwidth 100 mV/A gain
	Laser current “Slow” High-gain (J46 closed)	Readout of laser current, low-pass filtered 200 kHz bandwidth 1 V/A gain
TP16 (red)	Camera Master external supply	External supply input for logic levels interface
TP17 (purple)	Camera Master (logic levels)	Camera master digital input
TP18 (blue)	Camera Master (industrial levels)	Camera Master digital input at selectable 12 V or 24 V levels
TP19 (green)	Camera Master Passive	Clean contact to GND for Camera Master strobe
TP20 (yellow)	PWM output	Test point for on-board PWM oscillator

Label	Function	Description
TP21 (white)	Camera Master output	Test point for Camera Master strobe
TP22 (brown)	Camera Sync output	Test point for the AND logic between Camera Master and the on-board PWM oscillators
TP23 (white) TP24 (white)	VCSEL Interlock pins (PMSIL+ only)	Connected to PMSIL+ safety interlock pins

Figure 58:
Caption to J2 Pins

Pin	Signal (5 V logic level)
1	Board error (latched, Active_High). A driver error occurred. If present, it disables laser power supply until reset.
2	Not connected
3	GND
4	Driver error (real-time, Active_Low). Usually related to driver IC over-heating. It sets Pin1 latched error and prevents board reset until present.
5	Laser power supply status. High: Good. Low: disabled or failure.

7.3 Controls and Indicators

The Figure 59 and Figure 60 tables below list the on-board available controls and the light indicators and their meaning.

Figure 59:
Board Controls

Label	Function	Description
SW1	Power switch	Switch to power on/off the board after external power has been applied to J1
SW2	Board alarm reset	Push-button to clear the board alarm
R58	Pulsed current setting	Trimmer to set the pulsed current peak amplitude
R61	Bias current setting	Trimmer to set the bias current level
R88	PWM duty cycle	Trimmer to set the duty cycle of the on-board PWM oscillator
R95	Laser supply voltage	Trimmer to set the level of the laser supply voltage
R126	TP15 offset adjust	Trimmer to null the offset of the “Slow” current readout at TP15 (purple)

Label	Function	Description
R138	TP14 offset adjust	Trimmer to null the offset of the “Slow” voltage readout at TP14 (green)

Figure 60:
Light Indicators

Label	Color	Meaning When On
DL1	Red	A laser driver error is present (usually due to over-heating)
DL2	Blue	Laser strobe/trigger is present
DL3	Green	Board is powered on
DL4	Yellow	Board disabled (A laser driver error occurred and has been latched)

8 Revision Information

Changes from previous version to current revision v1-00	Page
Updated Figure 2	5
Added section 5 “How to Operate the Board”	32 - 50

- Page and figure numbers for the previous version may differ from page and figure numbers in the current revision.
- Correction of typographical errors is not explicitly mentioned.

9 Legal Information

Copyrights & Disclaimer

Copyright ams AG, Tobelbader Strasse 30, 8141 Premstaetten, Austria-Europe. Trademarks Registered. All rights reserved. The material herein may not be reproduced, adapted, merged, translated, stored, or used without the prior written consent of the copyright owner.

Demo Kits, Evaluation Kits and Reference Designs are provided to recipient on an "as is" basis for demonstration and evaluation purposes only and are not considered to be finished end-products intended and fit for general consumer use, commercial applications and applications with special requirements such as but not limited to medical equipment or automotive applications. Demo Kits, Evaluation Kits and Reference Designs have not been tested for compliance with electromagnetic compatibility (EMC) standards and directives, unless otherwise specified. Demo Kits, Evaluation Kits and Reference Designs shall be used by qualified personnel only.

ams AG reserves the right to change functionality and price of Demo Kits, Evaluation Kits and Reference Designs at any time and without notice.

Any express or implied warranties, including, but not limited to the implied warranties of merchantability and fitness for a particular purpose are disclaimed. Any claims and demands and any direct, indirect, incidental, special, exemplary or consequential damages arising from the inadequacy of the provided Demo Kits, Evaluation Kits and Reference Designs or incurred losses of any kind (e.g. loss of use, data or profits or business interruption however caused) as a consequence of their use are excluded.

ams AG shall not be liable to recipient or any third party for any damages, including but not limited to personal injury, property damage, loss of profits, loss of use, interruption of business or indirect, special, incidental or consequential damages, of any kind, in connection with or arising out of the furnishing, performance or use of the technical data herein. No obligation or liability to recipient or any third party shall arise or flow out of ams AG rendering of technical or other services.

RoHS Compliant & ams Green Statement

RoHS Compliant: The term RoHS compliant means that ams AG products fully comply with current RoHS directives. Our semiconductor products do not contain any chemicals for all 6 substance categories plus additional 4 substance categories (per amendment EU 2015/863), including the requirement that lead not exceed 0.1% by weight in homogeneous materials. Where designed to be soldered at high temperatures, RoHS compliant products are suitable for use in specified lead-free processes.

ams Green (RoHS compliant and no Sb/Br/Cl): ams Green defines that in addition to RoHS compliance, our products are free of Bromine (Br) and Antimony (Sb) based flame retardants (Br or Sb do not exceed 0.1% by weight in homogeneous material) and do not contain Chlorine (Cl) not exceed 0.1% by weight in homogeneous material).

Important Information: The information provided in this statement represents ams AG knowledge and belief as of the date that it is provided. ams AG bases its knowledge and belief on information provided by third parties, and makes no representation or warranty as to the accuracy of such information. Efforts are underway to better integrate information from third parties. ams AG has taken and continues to take reasonable steps to provide representative and accurate information but may not have conducted destructive testing or chemical analysis on incoming materials and chemicals. ams AG and ams AG suppliers consider certain information to be proprietary, and thus CAS numbers and other limited information may not be available for release.

Headquarters

ams AG
Tobelbader Strasse 30
8141 Premstaetten
Austria, Europe
Tel: +43 (0) 3136 500 0

Please visit our website at www.ams.com

Buy our products or get free samples online at www.ams.com/Products

Technical Support is available at www.ams.com/Technical-Support

Provide feedback about this document at www.ams.com/Document-Feedback

For sales offices, distributors and representatives go to www.ams.com/Contact

For further information and requests, e-mail us at ams_sales@ams.com