

Driver LCO 96W 700/1050/1400/2000/2670mA 0-10V C ADV UNV
OUTDOOR advanced series

**Product description**

- _ Constant current LED driver
- _ Only for US applications
- _ Dimmable via 0 ... 10 V interface
- _ Dimming range 10 to 100 %
- _ UL Listed Class P
- _ FCC Part 15
- _ Dry and damp location
- _ Max. output power 96 W
- _ Up to 92 % efficiency
- _ Nominal lifetime up to 100,000 h
- _ 5 years guarantee (conditions at www.tridonic.com)

Housing properties

- _ Metal casing black
- _ Potted style
- _ Type of protection IP67

Functions

- _ Over voltage protection
- _ Short-circuit protection
- _ No-load protection

Typical applications

- _ For cobra head, high bay and street applications

Website

<http://www.tridonic.us/28002163>



Spotlights



Downlights



Linear



Area



Floor | Wall



Free-standing



Street



Decorative

Driver LCO 96W 700/1050/1400/2000/2670mA 0-10V C ADV UNV
 OUTDOOR advanced series

The complete data sheet for this product is available in the Downloads section.

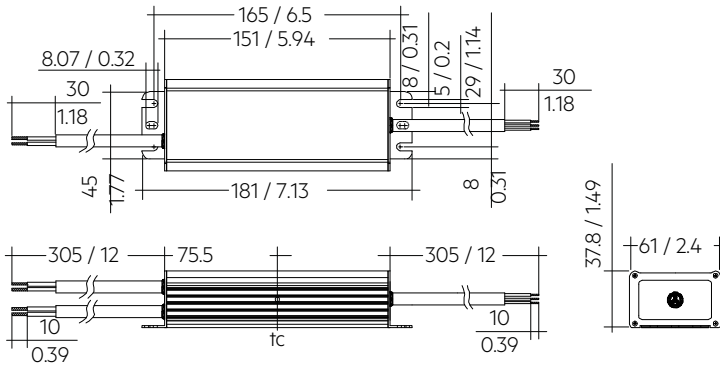

Dimensions in mm / inch

Approval marks



Standards

UL 8750, UL 1310, FCC PART 15, ANSI C62.41, ANSI C63.4, UL 1012, NEMA 4, CSA C22.2