

GT5 Series

— Connectors for Coaxial Cables —

(In-line type, Board type, Hybrid type, Waterproof type)

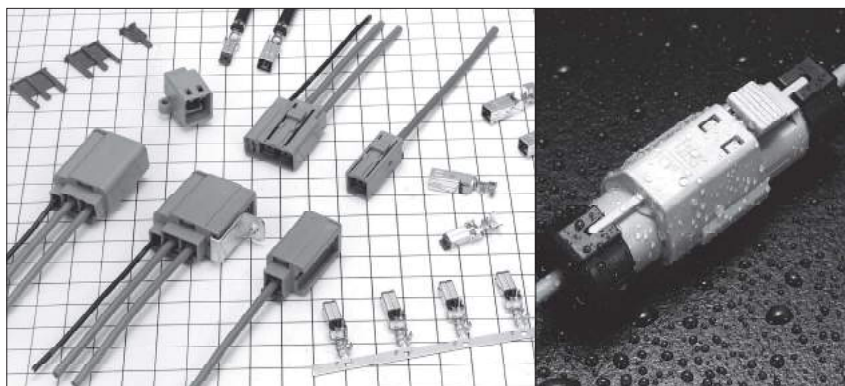

■ Features

● Cost performance:

Labor costs can be kept low because signal wires and shield wires can be crimped in one step. Additionally, the cable assembly process is semi-automatic.

● Excellent high frequency performance

Please refer to V.S.W.R data on the following pages.

■ Applications

For car TV, radio antenna, etc.

◆ TEST DATA (using 1.5D-2V Type cable)

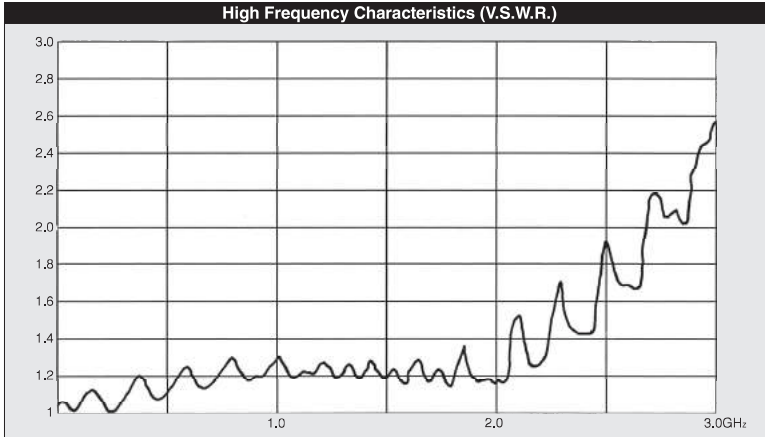

(Note) The above measurement data is for GT5-1S-HU and GT5-1PP-HU.

◆ Cable Assembly Instructions

1. Strip the cable.

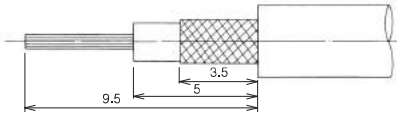

3. Insert the terminal into the housing. (Push it in until the housing lance latches.)

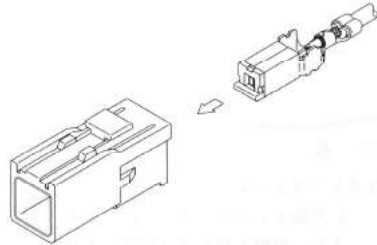

2. Crimp the cable to the terminal.

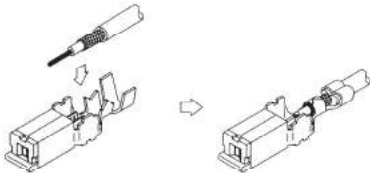

4. Attach the retainer (Push in the retainer until it locks.)

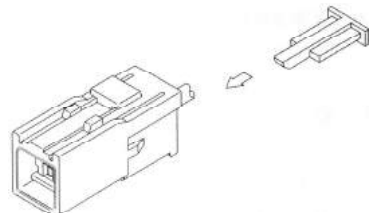

Apr. 1, 2023 Copyright 2023 HIROSE ELECTRIC CO., LTD. All Rights Reserved. GT5 GT13 GT16 GT19 FH65 FH40 FH35 FH67

Terminal for Coaxial Cable

F Connector Terminals

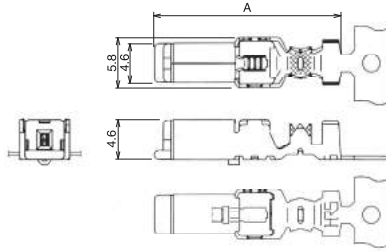

Part No.	HRS No.	Material / Finish or color	Conductor size	Insulator outer diameter	Jacket outer diameter	A	Sales unit	RoHS
GT5-30/0.7-1.5SCF(70)	755-0065-1 70	Insulator : PBT/Dark gray Center terminal : Phosphor bronze/Tin plating Outer terminal : Brass/Tin plating	AWG#30	φ0.6~0.9	φ1.4~1.8	22.7	1,300pcs/reel	○
GT5-2428/1.1-2.2SCF	755-0123-6		AWG#24~28	φ1.0~1.4	φ2.0~2.4	21.7		
GT5-2428/1.6-2.5SCF(70)	755-0078-3 70		AWG#30	φ1.5~2.0	φ2.3~2.7			
GT5-30/1.6-2.9SCF(70)	755-0022-9 70		AWG#24~28	φ2.0~2.5	φ3.3~3.7	22.7		
GT5-2428/1.6-2.9SCF(70)	755-0002-1 70		AWG#30	φ2.5~2.9	φ3.6~4.0			
GT5-2022/1.6-2.9SCF(70)	755-0071-4 70		AWG#20~22	φ2.5~2.9	φ4.6~5.0	22.7		
GT5-2022/F2.7-3.5SCF(70)	755-0077-0 70		AWG#24~28					
GT5-2022/F3.3-3.8SCF(70)	755-0054-5 70		AWG#30	φ3.0~3.6	AWG#20~22			
GT5-30/F3.3-5SCF(70)	755-0016-6 70		AWG#24~28					
GT5-2428/F3.3-5SCF(70)	755-0012-5 70		AWG#20~22	φ3.0~3.6	AWG#20~22			
GT5-2022/F3.3-5SCF(70)	755-0034-8 70	AWG#30						
GT5-30/F4-5SCF(70)	755-0020-3 70	AWG#24~28	φ3.0~3.6	AWG#20~22				
GT5-2428/F4-5SCF(70)	755-0024-4 70	AWG#20~22						
GT5-2022/F4-5SCF(70)	755-0036-3 70							

Note : Products marked with an asterisk (*) support insulators made of polyethylene foam.

M Connector Terminals

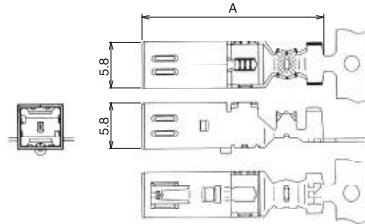

Part No.	HRS No.	Material / Finish or color	Conductor size	Insulator outer diameter	Jacket outer diameter	A	Sales unit	RoHS
GT5-30/0.7-1.5PCF(70)	755-0017-9 70	Insulator : PBT/Dark gray Center terminal : Brass/Tin plating Outer terminal : Brass/Tin plating	AWG#30	φ0.6~0.9	φ1.4~1.8	24.05	900pcs/reel	○
GT5-30/1.6-2.9PCF(70)	755-0021-6 70		AWG#24~28	φ1.5~2.0	φ2.6~3.4	23.05		
GT5-2428/1.6-2.9PCF(70)	755-0001-9 70		AWG#20~22	φ2.0~2.5	φ3.3~3.7			
GT5-2022/1.6-2.9PCF(70)	755-0094-0 70		AWG#30	φ2.5~2.9	φ3.6~4.0	24.05		
GT5-2022/F2.7-3.5PCF(70)	755-0076-8 70		AWG#24~28	φ2.5~2.9	φ4.6~5.0			
GT5-2022/F3.3-3.8PCF(70)	755-0053-2 70		AWG#20~22					
GT5-30/F3.3-5PCF(70)	755-0015-3 70		AWG#30	φ3.0~3.6	AWG#20~22			
GT5-2428/F3.3-5PCF(70)	755-0011-2 70		AWG#24~28					
GT5-2022/F3.3-5PCF(70)	755-0033-5 70		AWG#20~22	φ3.0~3.6	AWG#20~22			
GT5-30/F4-5PCF(70)	755-0019-4 70		AWG#30					
GT5-2428/F4-5PCF(70)	755-0023-1 70	AWG#24~28	φ3.0~3.6	AWG#20~22				
GT5-2022/F4-5PCF(70)	755-0035-0 70	AWG#20~22						

Note : Products marked with an asterisk (*) support insulators made of polyethylene foam.

Terminal for Low-insertion M Connector

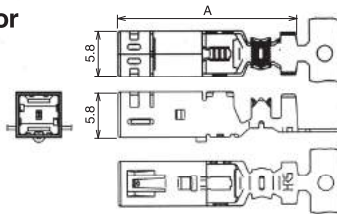

Part No.	HRS No.	Material / Finish or color	Conductor size	Insulator outer diameter	Jacket outer diameter	A	Sales unit	RoHS
GT5L30/0.7-1.5PCF(70)	755-0068-0 70	Insulator : PBT/Dark gray Center terminal : Brass/Tin plating Outer terminal : Brass/Tin plating	AWG#30	φ0.6~0.9	φ1.4~1.8	24.05	900pcs/reel	○
GT5L2428/1.6-2.5PCF(70)	755-0079-6 70		AWG#24~28	φ1.5~2.0	φ2.3~2.7	23.05		
GT5L30/1.6-2.9PCF(70)	755-0067-7 70		AWG#30		φ2.6~3.4			
GT5L2428/1.6-2.9PCF(70)	755-0066-4 70		AWG#24~28					

GT5
GT13
GT16
GT19
GT21
GT36
GT43
GT17
GT32
GT25
KM37
ZE05
ZG05J2
HM-H-200
ZE64W
H207U
FK26
DE40
DE40GL
FH28K
FH2K
FH65
FH40
FH63S
FH67

1 Pos. for Coaxial Cable

F Connector

● Housing



GT5-1S-HU

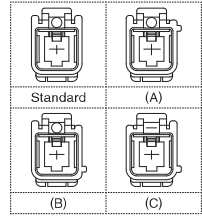
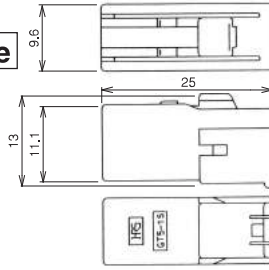

◆ Shown with retainer inserted.

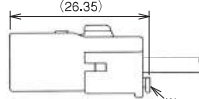

*Use together with separate retainer (GT5-1P/S-R) sold separately.

Part No.	HRS No.	Material	Color	Key position	Corresponding M Connector Housing	Corresponding M Connector Board-Mounting	Sales unit	RoHS
GT5-1S-HU	755-0004-7	PBT	Light gray	Standard	GT5-1PP-HU(70)	GT5-1P-DS(70)	1	○
GT5-1S-HU(A)	755-0037-6		Brown	(A)	GT5-1PP-HU(A)(70)	GT5-1P-DS(A)(70)		
GT5-1S-HU(B)	755-0038-9		Green	(B)	GT5-1PP-HU(B)(70)	GT5-1P-DS(B)(70)		
GT5-1S-HU(C)	755-0080-5		Blue	(C)	GT5-1PP-HU(C)(70)	GT5-1P-DS(C)(70)		

*M connector mating table (Use types with matching key positions as described above.)

● Retainer (Used with: GT5-1S-HU, GT5-1PP-HU, GT5N-1PP-HU, GT5H-1PP-HU)



Part No.	HRS No.	Material	Color	Sales unit	RoHS
GT5-1P/S-R	755-0006-2	PBT	Dark gray	1	○

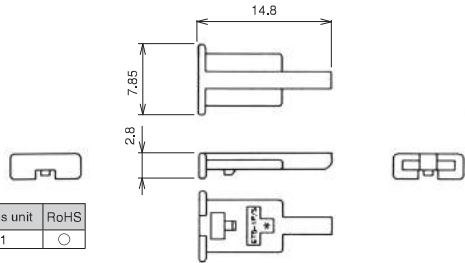

● Housing (Retainer Not Required)



GT5R-1S-HU

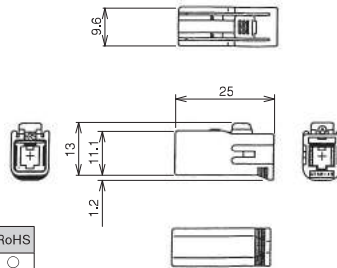

Part No.	HRS No.	Material	Color	Sales unit	RoHS
GT5R-1S-HU	755-0047-0	PBT	Light gray	1	○

Apr. 1. 2023 Copyright 2023 HIROSE ELECTRIC CO., LTD. All Rights Reserved.

GT5
 GT13
 GT16
 GT19
 HIROSE ELECTRIC CO., LTD. All Rights Reserved.
 FH65
 FH40
 FH35
 FH67

M Connector

● Housing

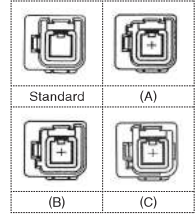
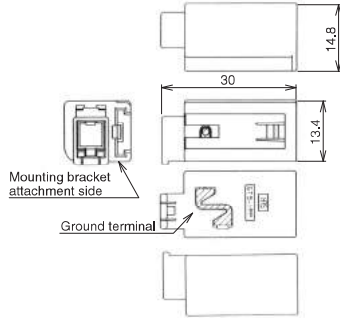

◆ Shown with retainer inserted.

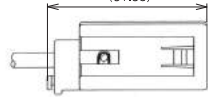

*Use together with separate retainer (GT5-1P/S-R) sold separately.

Part No.	HRS No.	Corresponding F Connector Housing	Material / Finish	Color	Key position	Sales unit	RoHS
GT5-1PP-HU(70)	755-0005-0 70	GT5-1S-HU	Housing: PBT	Light gray	Standard	1	○
GT5-1PP-HU(A)(70)	755-0039-1 70	GT5-1S-HU (A)	Ground terminal: Phosphor	Brown	(A)		
GT5-1PP-HU(B)(70)	755-0040-0 70	GT5-1S-HU (B)		Green	(B)		
GT5-1PP-HU(C)(70)	755-0103-9 70	GT5-1S-HU (C)	bronze/Tin plating	Blue	(C)		

*See page 17 for panel mounting in-line bracket.

*Please use a corresponding F connector housing with a matching key type.

● Housing (H type bracket)

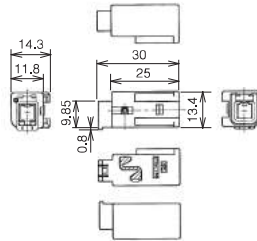

◆ Mated Connector

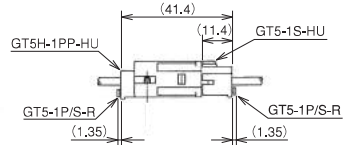

*Use together with separate retainer (GT5-1P/S-R) sold separately.

Part No.	HRS No.	Material	Color	Corresponding F Connector	Sales unit	RoHS
GT5H-1PP-HU(10)	755-0093-7 10	PBT	Light gray	GT5-1S-HU GT5R-1S-HU	1	○

● Housing (N type bracket)

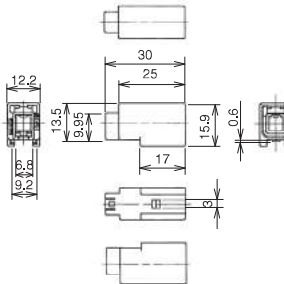

◆ Mated Connector

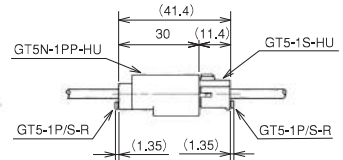

*Use together with separate retainer (GT5-1P/S-R) sold separately.

Part No.	HRS No.	Material	Color	Corresponding F Connector	Sales unit	RoHS
GT5N-1PP-HU	755-0090-9	PBT	Light gray	GT5-1S-HU GT5R-1S-HU	1	○

● Housing

〔 Panel Mount type
Enforced Shield type 〕

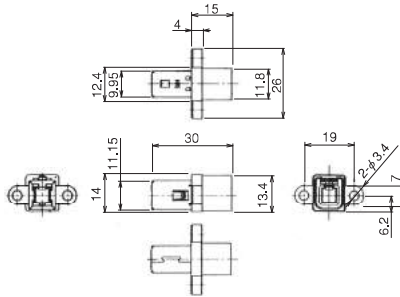
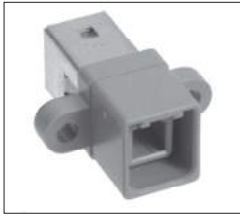

◆ Recommended Panel Dimensions

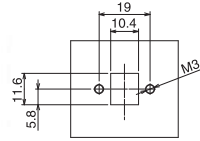

◆ Mated Connector

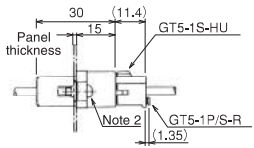

Part No.	HRS No.	Material / Finish or color	Corresponding F Connector	Sales unit	RoHS
GT5A-1PP-HU(70)	755-0025-7 70	Housing : PBT/ Light gray Ground terminal : Brass/Tin plating	GT5-1S-HU GT5R-1S-HU	1	○

Note 1 : This product does not require a retainer.

Note 2 : Use M3 screws listed in JIS B 1111 and 1101 M3 screws for mounting screws.

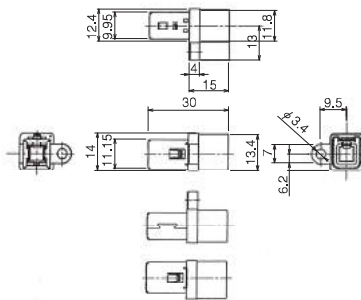

◆ Recommended Panel Dimensions

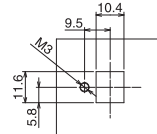

Part No.	HRS No.	Material / Finish or color	Corresponding F Connector	Sales unit	RoHS
GT5P-1PP-HU(70)	755-0030-7 70	Housing : PBT/ Light gray Ground terminal : Brass/Tin plating	GT5-1S-HU GT5R-1S-HU	1	○

Note 1 : This product does not require a retainer.

Note 2 : Use M3 screws listed in JIS B 1111 and 1101 M3 screws for mounting screws.

GT5
 GT13
 GT16
 GT19
 HIROSE ELECTRIC CO., LTD. All Rights Reserved.
 FH65
 FH40
 FH35
 FH67

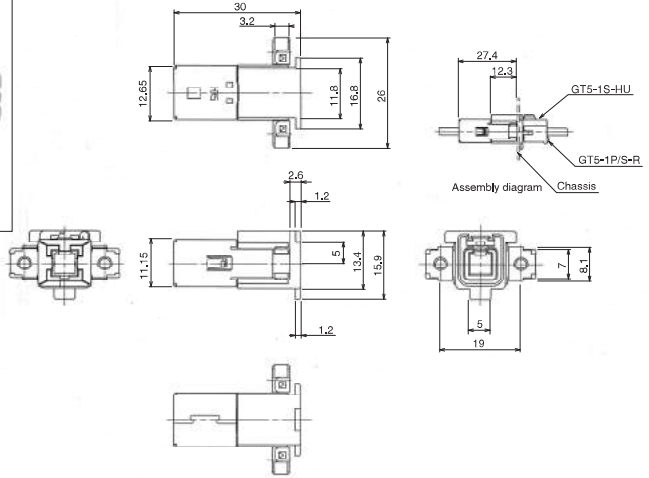

Part No.	HRS No.	Material / Finish or color	Corresponding F Connector	Sales unit	RoHS
GT5B-1PP-HU(70)	755-0051-7 70	Housing : PBT/ Light gray Ground terminal : Phosphor bronze/Tin plating	GT5-1S-HU GT5R-1S-HU	1	○

Note 1 : This product does not require a retainer.

Note 2 : Use JIS B 1115 and 1122 class 4, nominal diameter 3, length 6 screws for the mounting screws.

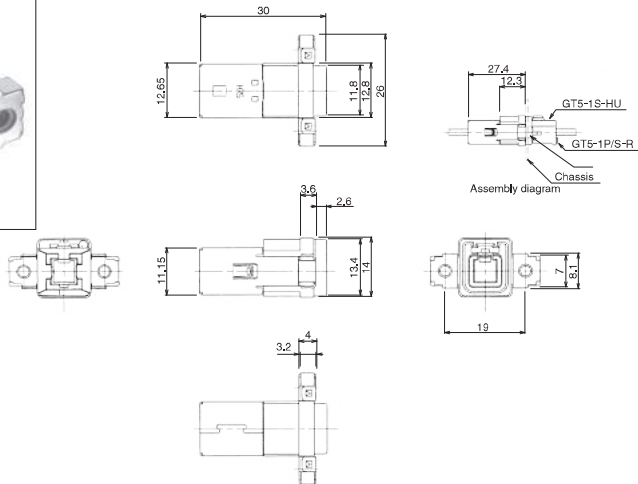

Part No.	HRS No.	Material / Finish or color	Corresponding F Connector	Sales unit	RoHS
GT5S-1PP-HU(70)	755-0050-4 70	Housing : PBT/ Light gray Ground terminal : Phosphor bronze/Tin plating	GT5-1S-HU GT5R-1S-HU	1	○

Note 1 : This product does not require a retainer.

Note 2 : Use JIS B 1115 and 1122 class 4, nominal diameter 3, length 6 screws for the mounting screws.

● Board Mount type

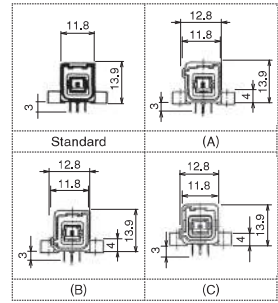
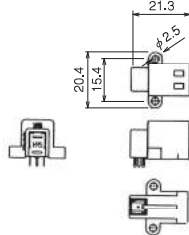

◆ Mated Connector

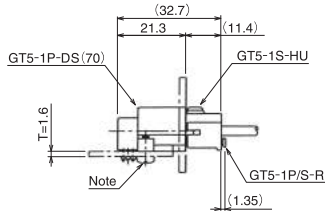

◆ Recommended Board Dimensions

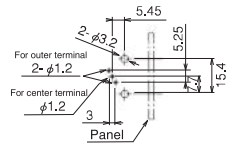

Part No.	HRS No.	Material / Finish or color	Color	Key position	Corresponding connector	Sales unit	RoHS
GT5-1P-DS(70)	755-0007-5 70	Housing : PBT	Light gray	Standard	GT5-1S-HU	1	○
GT5-1P-DS(A)(70)	755-0041-3 70	Center terminal : Brass/Tin plating	Brown	(A)	GT5-1S-HU(A)		
GT5-1P-DS(B)(70)	755-0042-6 70	Insulator : PBT/Dark gray	Green	(B)	GT5-1S-HU(B)		
GT5-1P-DS(C)(70)	755-0083-3 70	Outer terminal : Phosphor bronze/Tin plating	Blue	(C)	GT5-1S-HU(C)		

Note : Use JIS B 1115 and 1122 class 4, nominal diameter 3, length 6 screws (for a board thickness of 1.6 mm) for the mounting screws.
 *Six types of keys are available.
 Please use a corresponding F connector housing with a matching key type.

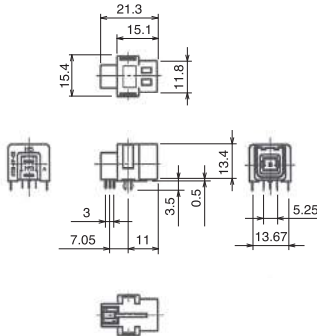

◆ Mated Connector

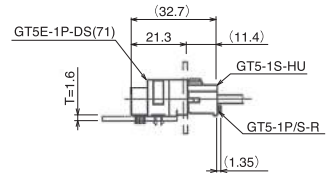

◆ Recommended Board Dimensions

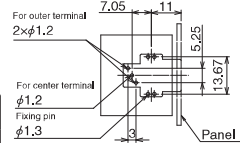

Part No.	HRS No.	Material / Finish or color	Corresponding connector	Sales unit	RoHS
GT5E-1P-DS(71)	755-0125-1 71	Housing : PA/ Natural Center terminal : Brass/Tin plating Insulator : PA/Black Outer terminal : Phosphor bronze/Tin plating Fixing pin : Brass/ Tin plating	GT5-1S-HU GT5R-1S-HU	1	○

1 Pos. for Coaxial Cable, Waterproof type

■ F Connector

● Housing

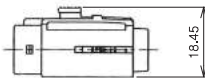
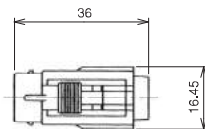

Part No.	HRS No.	Material	Color	Sales unit	RoHS
GT5W-1S-HU	755-0027-2	PBT	Light gray	1	○

Note : Use this product with a retainer that matches the cable.

● Retainer (Used with: GT5W-1PP-HU, GT5JW-1PP-HU, GT5W-1S-HU, GT5W-1P-HU)

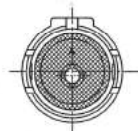
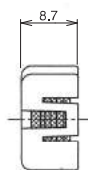
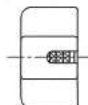
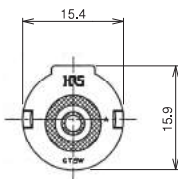

Part No.	HRS No.	Material / Finish or color	Sales unit	RoHS
GT5W-1P/S-R	755-0028-5	Retainer : PBT/Dark gray Rubber : Silicon rubber/Light blue	1	○

*This product supports cables with outer diameters of $\phi 2.9$ to $\phi 3.4$.
Waterproofness will depend on the cable. Please contact Hirose Electric if you intend to use cables other than those recommended.

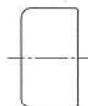

GT5
GT13
GT16
GT19
GT21
GT36
GT43
GT17
GT32
GT25
KM37
ZE05
ZG052
HM-200
ZBK4W
H202L
FX26
DE40
DF40GL
FH28K
FH2K
FH65
FH40
FH63
FH67

M Connector

Housing

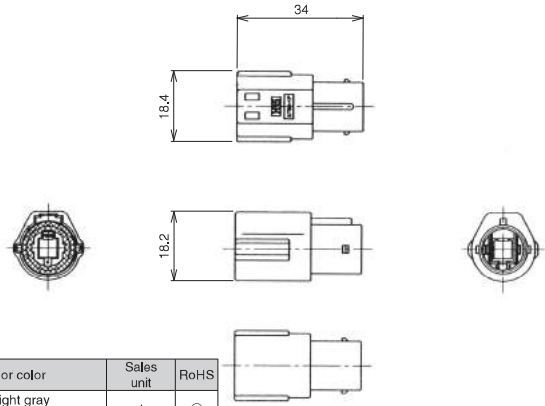

Part No.	HRS No.	Material / Finish or color	Sales unit	RoHS
GT5W-1P-HU	755-0026-0	Housing : PBT/ Light gray Connector seal : Silicon rubber/White	1	○

Note : Use this product with a retainer that matches the cable.

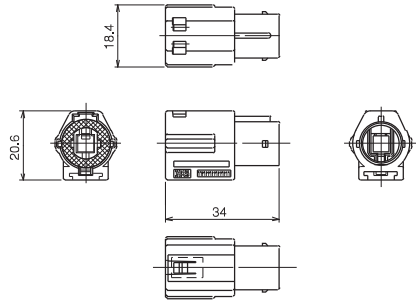

Recommended Bracket Dimensions (Used with GT5W-1PP-HU)

Please check with Hirose for information on the bracket for GT5JW-1PP-HU.

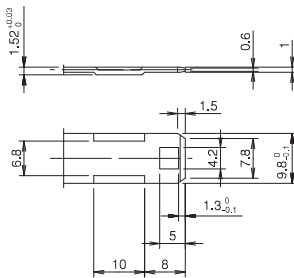

Mated Connector

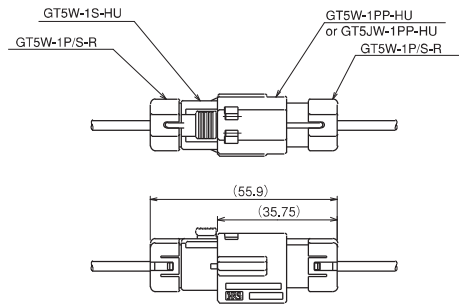

Part No.	HRS No.	Material / Finish or color	Sales unit	RoHS
GT5W-1PP-HU	755-0070-1	Housing : PBT/ Light gray Connector seal : Silicon rubber/White	1	○
GT5JW-1PP-HU	755-0069-2			

Note : Use this product with a retainer that matches the cable.

Apr. 1. 2023 Copyright 2023 HIROSE ELECTRIC CO., LTD. All Rights Reserved.

G Terminal

■ For Cable Termination Part

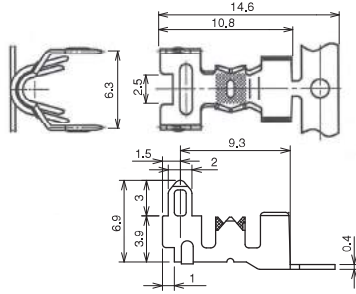
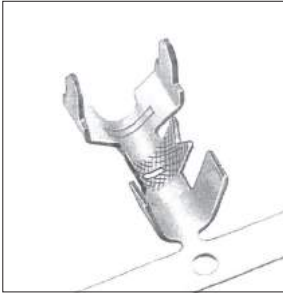

◆ Recommended Cable Assembly Diagram

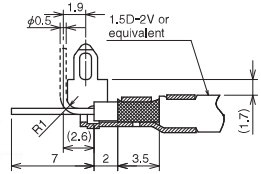

◆ Recommended Board Dimensions

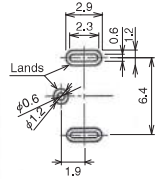

Part No.	HRS No.	Material	Finish	Sales unit	RoHS
GTA-1.6CF(70)	755-0032-2 70	Brass	Tin plating	1,500 pcs/reel	○

◆ Recommended Cable Assembly Diagram

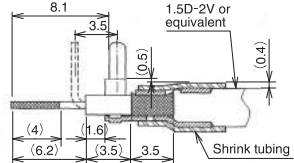
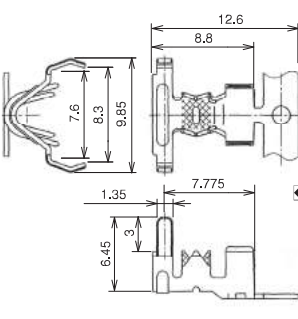
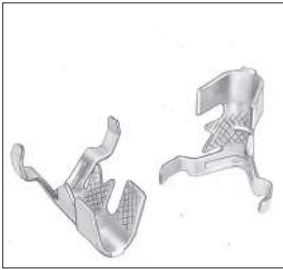

◆ Recommended Board Dimensions

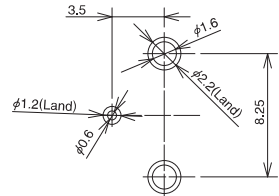

Part No.	HRS No.	Material	Finish	Sales unit	RoHS
GTB-1.6CF(70)	755-0049-5 70	Brass	Tin plating	1,500 pcs/reel	○

◆ Recommended Cable Assembly Diagram

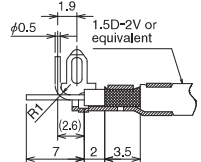
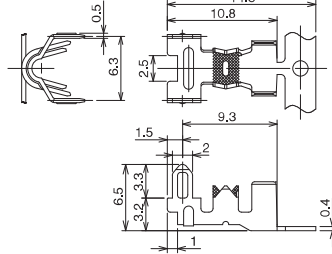

◆ Recommended Board Dimensions

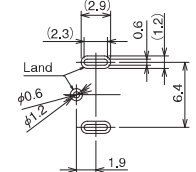

Part No.	HRS No.	Material	Finish	Sales unit	RoHS
GTG-1.6CF	755-0106-7	Brass	Tin plating	1,500 pcs/reel	○

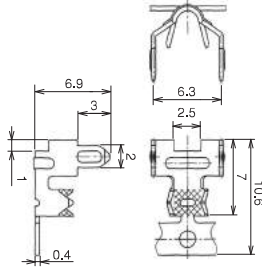
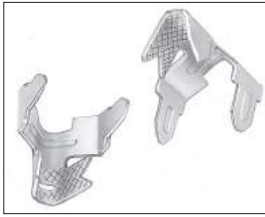

Part No.	HRS No.	Material	Finish	Sales unit	RoHS
G-1.6PCF(70)	755-0029-8 70	Brass	Tin plating	1,500 pcs/reel	○

◆ Recommended Cable Assembly Diagram

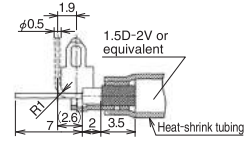

◆ Recommended Board Dimensions

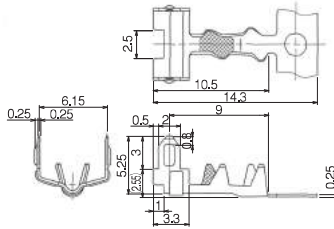
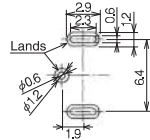

Part No.	HRS No.	Material	Finish	Sales unit	RoHS
GTA-0.7CF	755-0074-2	Brass	Tin plating	1,500 pcs/reel	○

◆ Recommended Cable Assembly Diagram

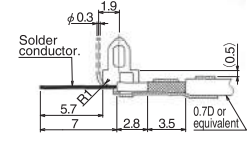

◆ Recommended Board Dimensions

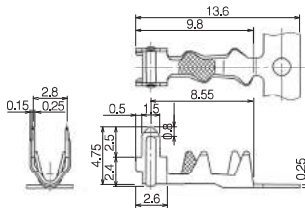
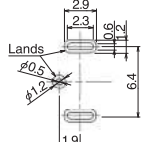

Part No.	HRS No.	Material	Finish	Sales unit	RoHS
GTB-0.7CF	755-0075-5	Brass	Tin plating	1,500 pcs/reel	○

◆ Recommended Cable Assembly Diagram

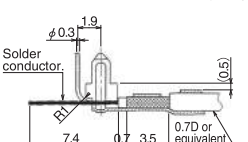

◆ Recommended Board Dimensions

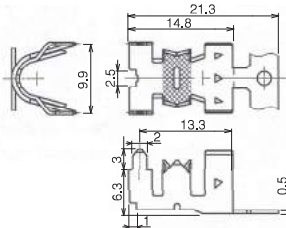
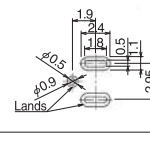

Part No.	HRS No.	Material	Finish	Sales unit	RoHS
GTE-3.7CF	755-0122-3	Brass	Tin plating	1,100 pcs/reel	○

◆ Recommended Cable Assembly Diagram

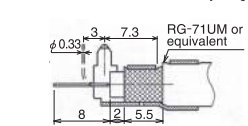

◆ Recommended Board Dimensions

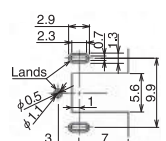

GT5 GT13 GT16 GT19 GT22 GT25 GT28 GT31 GT34 GT37 GT40 GT43 GT46 GT49 GT52 GT55 GT58 GT61 GT64 GT67 GT70 GT73 GT76 GT79 GT82 GT85 GT88 GT91 GT94 GT97 GT100 GT103 GT106 GT109 GT112 GT115 GT118 GT121 GT124 GT127 GT130 GT133 GT136 GT139 GT142 GT145 GT148 GT151 GT154 GT157 GT160 GT163 GT166 GT169 GT172 GT175 GT178 GT181 GT184 GT187 GT190 GT193 GT196 GT199 GT202 GT205 GT208 GT211 GT214 GT217 GT220 GT223 GT226 GT229 GT232 GT235 GT238 GT241 GT244 GT247 GT250 GT253 GT256 GT259 GT262 GT265 GT268 GT271 GT274 GT277 GT280 GT283 GT286 GT289 GT292 GT295 GT298 GT301 GT304 GT307 GT310 GT313 GT316 GT319 GT322 GT325 GT328 GT331 GT334 GT337 GT340 GT343 GT346 GT349 GT352 GT355 GT358 GT361 GT364 GT367 GT370 GT373 GT376 GT379 GT382 GT385 GT388 GT391 GT394 GT397 GT400 GT403 GT406 GT409 GT412 GT415 GT418 GT421 GT424 GT427 GT430 GT433 GT436 GT439 GT442 GT445 GT448 GT451 GT454 GT457 GT460 GT463 GT466 GT469 GT472 GT475 GT478 GT481 GT484 GT487 GT490 GT493 GT496 GT499 GT502 GT505 GT508 GT511 GT514 GT517 GT520 GT523 GT526 GT529 GT532 GT535 GT538 GT541 GT544 GT547 GT550 GT553 GT556 GT559 GT562 GT565 GT568 GT571 GT574 GT577 GT580 GT583 GT586 GT589 GT592 GT595 GT598 GT601 GT604 GT607 GT610 GT613 GT616 GT619 GT622 GT625 GT628 GT631 GT634 GT637 GT640 GT643 GT646 GT649 GT652 GT655 GT658 GT661 GT664 GT667 GT670 GT673 GT676 GT679 GT682 GT685 GT688 GT691 GT694 GT697 GT700 GT703 GT706 GT709 GT712 GT715 GT718 GT721 GT724 GT727 GT730 GT733 GT736 GT739 GT742 GT745 GT748 GT751 GT754 GT757 GT760 GT763 GT766 GT769 GT772 GT775 GT778 GT781 GT784 GT787 GT790 GT793 GT796 GT799 GT802 GT805 GT808 GT811 GT814 GT817 GT820 GT823 GT826 GT829 GT832 GT835 GT838 GT841 GT844 GT847 GT850 GT853 GT856 GT859 GT862 GT865 GT868 GT871 GT874 GT877 GT880 GT883 GT886 GT889 GT892 GT895 GT898 GT901 GT904 GT907 GT910 GT913 GT916 GT919 GT922 GT925 GT928 GT931 GT934 GT937 GT940 GT943 GT946 GT949 GT952 GT955 GT958 GT961 GT964 GT967 GT970 GT973 GT976 GT979 GT982 GT985 GT988 GT991 GT994 GT997 GT1000

Shield Plate

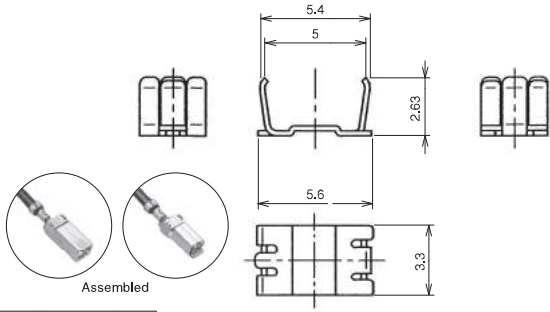

Part No.	HRS No.	Material	Finish	Sales unit	RoHS
GT5C-1P/S-CSB(70)	755-0048-2 70	Brass	Tin plating	1	○

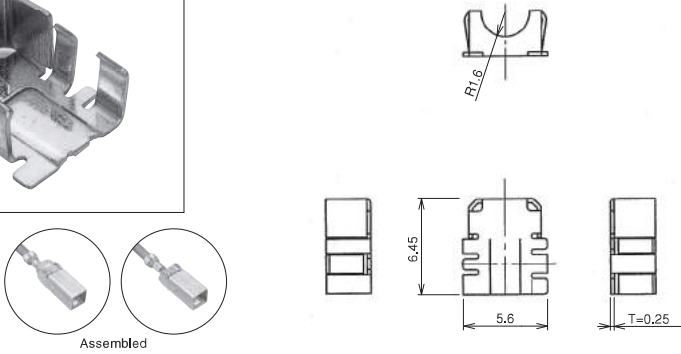
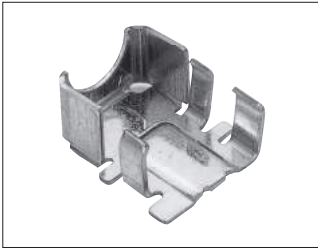

Part No.	HRS No.	Material	Finish	Sales unit	RoHS
GT5C-1P/S-CSB(70)	755-0088-7 70	Brass	Tin plating	1	○

Panel Mount In-line Bracket

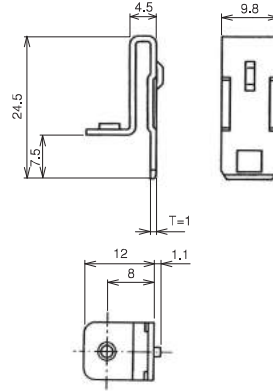

Part No.	HRS No.	Material	Finish	Used with connectors	Sales unit	RoHS
GT-BK(70)	751-0039-6 70	SPCC	Tin plating	GT5-1PP-HU(70), GT5-1PP-HU(A)(70), GT5-1PP-HU(B)(70) GT5-1PP-HU(C)(70), GT5-1PP-HU(D)(70) GT5-1PP-HU(E)(70), GT5-1PP-HU(F)(70) GT5-1PP-HU(G)(70), GT5-1PP-HU(H)(70) GT5-2/1PP-HU(70), GT5-2PP-HU(70) GT5-2PP-HU(A)(70), GT5-2PP-HU(B)(70) GT5-2PP-HU(C)(70)	1	○

Crimping Tools

Please ask your Hirose Electric account representative for a user manual.

Automatic Crimping Machine



Photo for reference only.
Subject to change.

Part No. CM-105C

Specifications

Item	Specifications	Remarks
Press capacity	1,5tons	
Stroke length	30mm	
Number of strokes	200spm (50Hz)	200spm (60Hz)
Weight	75kg	
Motor	0.2kW	AC100V
Crimping speed	2,000-4,000/H	

*Terminal crimp height setting tables are available for each cable type. Please contact your Hirose Electric account representative.

Please note that we will need to define new crimp heights for novel cables and this may take a few days.

● **Harness Tools**

Contact Product No.	Contact HRS No.	Tool No.	Tool HRS No.
GT5-30/0,7-1,5PCF(70)	755-0017-9 70	AP105-GT5-30/0,7-1,5P	901-5021-8
GT5-30/0,7-1,5SCF(70)	755-0065-1 70	AP105-GT5-30/0,7-1,5S	901-5080-7
GT5L-2428/1,6-2,5PCF(70)	755-0079-6 70	AP105-GT5-2428/1,6-2,5P	901-5100-2
GT5-2428/1,6-2,5SCF(70)	755-0078-3 70	AP105-GT5-2428/1,6-2,5S	901-5101-5
GT5-30/1,6-2,9PCF(70)	755-0021-6 70	AP105-GT5-30/1,6-2,9P-ID	901-5019-6
		AP105-GT5-30/1,6-2,9P	901-5017-0
GT5-30/1,6-2,9SCF(70)	755-0022-9 70	AP105-GT5-30/1,6-2,9S-ID	901-5020-5
		AP105-GT5-30/1,6-2,9S	901-5018-3
GT5-2428/1,6-2,9PCF(70)	755-0001-9 70	AP105-GT5-2428/1,6-2,9P	901-5029-0
		AP105-GT5-2428/1,6-2,9PWS	901-5031-3
		AP105-GT5-2428/1,6-2,9P-B	901-5103-0
GT5-2428/1,6-2,9SCF(70)	755-0002-1 70	AP105-GT5-2428/1,6-2,9S	901-5030-9
		AP105-GT5-2428/1,6-2,9SWS	901-5032-4
		AP105-GT5-2428/1,6-2,9S-B	901-5104-3
GT5-2022/1,6-2,9SCF(70)	755-0071-4 70	AP105-GT5-2022/1,6-2,9S	901-5088-9
GT5-2022/F2,7-3,5PCF(70)	755-0076-8 70	AP105-GT5-2022/F2,7-3,5P	901-5091-3
GT5-2022/F2,7-3,5SCF(70)	755-0077-0 70	AP105-GT5-2022/F2,7-3,5S	901-5092-6
GT5-2022/F3,3-3,8PCF(70)	755-0053-2 70	AP105-GT5-2022/F3,3-3,8P	901-5075-7
GT5-2022/F3,3-3,8SCF(70)	755-0054-5 70	AP105-GT5-2022/F3,3-3,8S	901-5076-0
GT5-2022/F3,3-5PCF(70)	755-0033-5 70	AP105-GT5-2022/F3,3-5P-ID	901-5058-8
		AP105-GT5-2022/F3,3-5P	901-5059-0
GT5-2022/F3,3-5SCF(70)	755-0034-8 70	AP105-GT5-2022/F3,3-5S-ID	901-5060-0
		AP105-GT5-2022/F3,3-5S	901-5061-2
GT5-30/F4-5PCF(70)	755-0019-4 70	AP105-GT5-30/F4-5P-ID	901-5033-7
GT5-30/F4-5SCF(70)	755-0020-3 70	AP105-GT5-30/F4-5S-ID	901-5034-0
GT5-2428/F4-5PCF(70)	755-0023-1 70	AP105-GT5-2428/F4-5P-ID	901-5035-2
		AP105-GT5-2428/F4-5P-3C2V	901-5056-2
GT5-2428/F4-5SCF(70)	755-0024-4 70	AP105-GT5-2428/F4-5S-ID	901-5036-5
		AP105-GT5-2428/F4-5S-3C2V	901-5057-5
GT5-2022/F4-5PCF(70)	755-0035-0 70	AP105-GT5-2022/F4-5P	901-5052-1
		AP105-GT5-2022/F4-5P-18ID	901-5121-2
GT5-2022/F4-5SCF(70)	755-0036-3 70	AP105-GT5-2022/F4-5S	901-5053-4
		AP105-GT5-2022/F4-5S-18ID	901-5102-8
G-1,6PCF(70)	755-0029-8 70	AP105-G-1,6P	901-5041-5
GTA-0,7CF	755-0074-2	AP105-GTA,B-0,7P	901-5141-0
GTB-0,7CF	755-0075-5	AP105-GTA,B-0,7P	901-5141-0
GTA-1,6CF(70)	755-0032-2 70	AP105-GTA,B-1,6P	901-5047-1
GTB-1,6CF(70)	755-0049-5 70	AP105-GTA,B-1,6P	901-5047-1
GTC-1,6CF	755-0106-7	AP105-GTA,B-1,6P	901-5047-1
GTE-3,7CF	755-0122-3	AP105-GTE-3,7	901-5151-3

Please refer to our cable termination procedure manual for performing terminations.

Apr. 1, 2023 Copyright 2023 HIROSE ELECTRIC CO., LTD. All Rights Reserved.