

CGHV35400F

400 W, 2.9 - 3.5 GHz, 50-Ohm Input/Output Matched, GaN HEMT for S-Band Radar Systems

Description

Cree's CGHV35400F is a gallium nitride (GaN) high electron mobility transistor (HEMT) designed specifically with high efficiency, high gain and wide bandwidth capabilities, which makes the CGHV35400F ideal for 2.9 - 3.5 GHz S-Band radar amplifier applications. The transistor is matched to 50-ohms on the input and 50-ohms on the output. The CGHV35400 is based on Cree's high power density 50 V, 0.4 μm GaN on silicon carbide (SiC) foundry process. The transistor is supplied in a ceramic/metal flange package, type 440225.

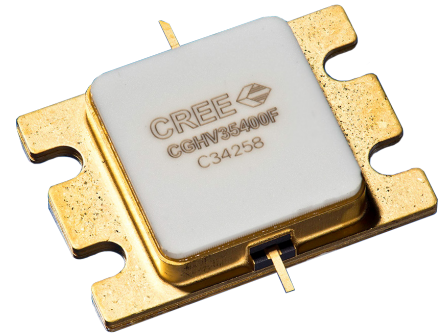

PN: CGHV35400F
Package Type: 440225

Typical Performance Over 2.9-3.5 GHz ($T_c = 25^\circ\text{C}$) of Demonstration Amplifier

Parameter	2.9 GHz	3.2 GHz	3.5 GHz	Units
Output Power	500	535	480	W
Gain	11.0	11.3	10.8	dB
Drain Efficiency	74	69	64	%

Note: Measured in the CGHV35400F-AMP application circuit, under 500 μs pulse width, 10% duty cycle, $P_{IN} = 46\text{ dBm}$.

Features

- 2.9 - 3.5 GHz Operation
- 500 W Typical Output Power
- 11 dB Power Gain
- 70% Typical Drain Efficiency
- 50 Ohm Internally Matched
- <0.3 dB Pulsed Amplitude Droop

 Large Signal Models Available for ADS and MWO

RoHS
COMPLIANT



Absolute Maximum Ratings (not simultaneous)

Parameter	Symbol	Rating	Units	Conditions
Pulse Width	PW	500	μs	
Duty Cycle	DC	10	%	
Drain-Source Voltage	V_{DSS}	150	Volts	25 °C
Gate-to-Source Voltage	V_{GS}	-10, +2	Volts	25 °C
Storage Temperature	T_{STG}	-65, +150	°C	
Operating Junction Temperature	T_J	225	°C	
Maximum Forward Gate Current	I_{GMAX}	80	mA	25 °C
Maximum Drain Current ¹	I_{DMAX}	24	A	25 °C
Soldering Temperature ²	T_S	245	°C	
Screw Torque	τ	40	in-oz	
Pulsed Thermal Resistance, Junction to Case	$R_{\theta JC}$	0.22	°C/W	100 μsec, 10%, 85 °C, $P_{DISS} = 418$ W
Pulsed Thermal Resistance, Junction to Case	$R_{\theta JC}$	0.30	°C/W	500 μsec, 10%, 85 °C, $P_{DISS} = 418$ W
Case Operating Temperature	T_C	-40, +125	°C	

Notes:

¹ Current limit for long term, reliable operation

² Refer to the Application Note on soldering at wolfspeed.com/rf/document-library

Electrical Characteristics

Characteristics	Symbol	Min.	Typ.	Max.	Units	Conditions
DC Characteristics ¹ ($T_C = 25^\circ\text{C}$)						
Gate Threshold Voltage	$V_{GS(th)}$	-3.8	-3.0	-2.3	V_{DC}	$V_{DS} = 10$ V, $I_D = 83.6$ mA
Gate Quiescent Voltage	$V_{GS(Q)}$	-	-2.7	-	V_{DC}	$V_{DS} = 50$ V, $I_D = 0.5$ A
Saturated Drain Current ²	I_{DS}	62.7	75.5	-	A	$V_{DS} = 6.0$ V, $V_{GS} = 2.0$ V
Drain-Source Breakdown Voltage	V_{BR}	125	-	-	V_{DC}	$V_{GS} = -8$ V, $I_D = 83.6$ mA

Notes:

¹ Measured on wafer prior to packaging

² Scaled from PCM data

Electrical Characteristics (Continued)

Characteristics	Symbol	Min.	Typ.	Max.	Units	Conditions
RF Characteristics ³ (T _c = 25°C, F _o = 2.9 - 3.5 GHz unless otherwise noted)						
Output Power at 2.9 GHz	P _{OUT1}	445	500	-	W	V _{DD} = 50 V, I _{DQ} = 500 mA, P _{IN} = 46 dBm
Output Power at 3.2 GHz	P _{OUT2}	475	535	-	W	V _{DD} = 50 V, I _{DQ} = 500 mA, P _{IN} = 46 dBm
Output Power at 3.5 GHz	P _{OUT3}	410	480	-	W	V _{DD} = 50 V, I _{DQ} = 500 mA, P _{IN} = 46 dBm
Gain at 2.9 GHz	G _{P1}	10.5	11	-	dB	V _{DD} = 50 V, I _{DQ} = 500 mA, P _{IN} = 46 dBm
Gain at 3.2 GHz	G _{P2}	10.75	11.3	-	dB	V _{DD} = 50 V, I _{DQ} = 500 mA, P _{IN} = 46 dBm
Gain at 3.5 GHz	G _{P3}	10.1	10.8	-	dB	V _{DD} = 50 V, I _{DQ} = 500 mA, P _{IN} = 46 dBm
Drain Efficiency at 2.9 GHz	D _{E1}	60	70	-	%	V _{DD} = 50 V, I _{DQ} = 500 mA, P _{IN} = 46 dBm
Drain Efficiency at 3.2 GHz	D _{E2}	60	70	-	%	V _{DD} = 50 V, I _{DQ} = 500 mA, P _{IN} = 46 dBm
Drain Efficiency at 3.5 GHz	D _{E3}	54	64	-	%	V _{DD} = 50 V, I _{DQ} = 500 mA, P _{IN} = 46 dBm
Small Signal Gain	S ₂₁	10.5	12	-	dB	V _{DD} = 50 V, I _{DQ} = 500 mA, P _{IN} = -10 dBm
Input Return Loss	S ₁₁	-	-8	-3.0	dB	V _{DD} = 50 V, I _{DQ} = 500 mA, P _{IN} = -10 dBm
Output Return Loss	S ₂₂	-	-8	-4.0	dB	V _{DD} = 50 V, I _{DQ} = 500 mA, P _{IN} = -10 dBm
Amplitude Droop	D	-	-0.3	-	dB	V _{DD} = 50 V, I _{DQ} = 500 mA, P _{IN} = 46 dBm
Output Stress Match	VSWR	-	5:1	-	Ψ	No damage at all phase angles, V _{DD} = 50 V, I _{DQ} = 500 mA, P _{IN} = 46 dBm Pulsed

Notes:

³ Measured in CGHV35400F-AMP. Pulse Width = 500 μS, Duty Cycle = 10%

Electrostatic Discharge (ESD) Classifications

Parameter	Symbol	Class	Test Methodology
Human Body Model	HBM	1A (> 250 V)	JEDEC JESD22 A114-D
Charge Device Model	CDM	II (200 < 500V)	JEDEC JESD22 C101-C



Typical Performance

Figure 1. CGHV35400F Typical S Parameters

$V_{DD} = 50\text{ V}$, $I_{DQ} = 0.5\text{ A}$

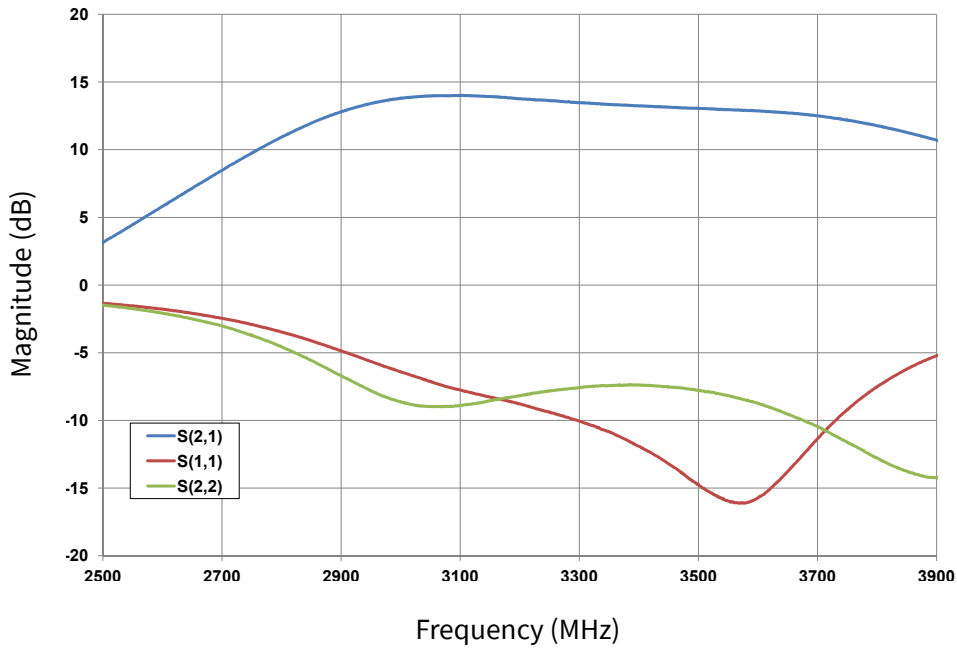
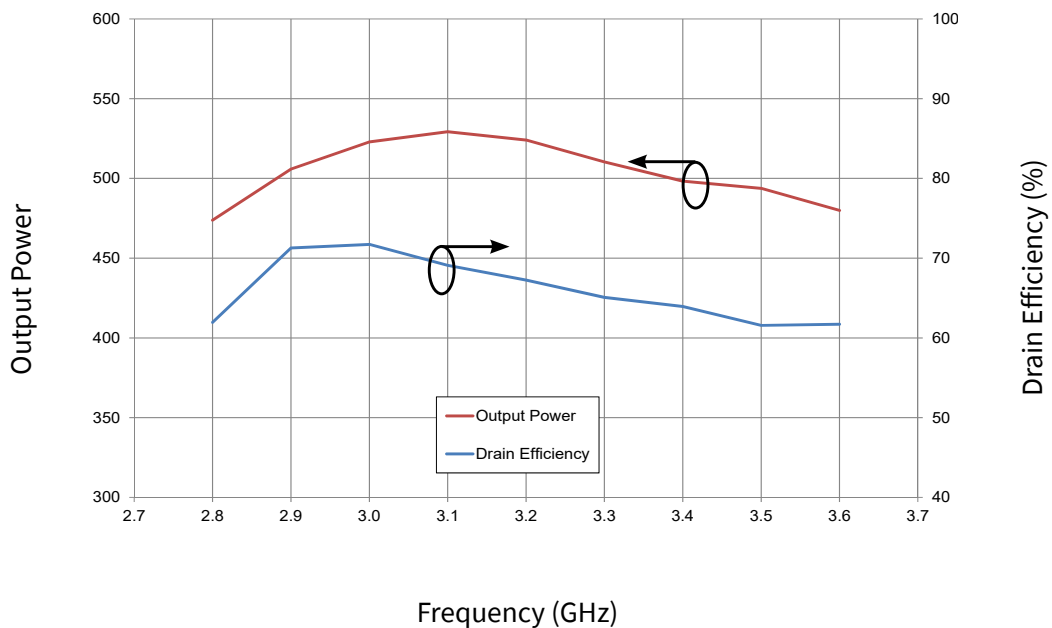

Figure 2. CGHV35400F P_{OUT} and Drain Efficiency vs Frequency at $T_{case} = 25^\circ\text{ C}$

$V_{DD} = 50\text{ V}$, $I_{DQ} = 0.5\text{ A}$, $P_{IN} = 46\text{ dBm}$, Pulse Width = $500\mu\text{s}$, Duty Cycle = 10%





Typical Performance

Figure 3. CGHV35400F Output Power vs Input Power
 $V_{DD} = 50\text{ V}$, $I_{DQ} = 500\text{ mA}$, Pulse Width = $500\ \mu\text{s}$, Duty = 10%, $T_{case} = 25\text{ }^\circ\text{C}$

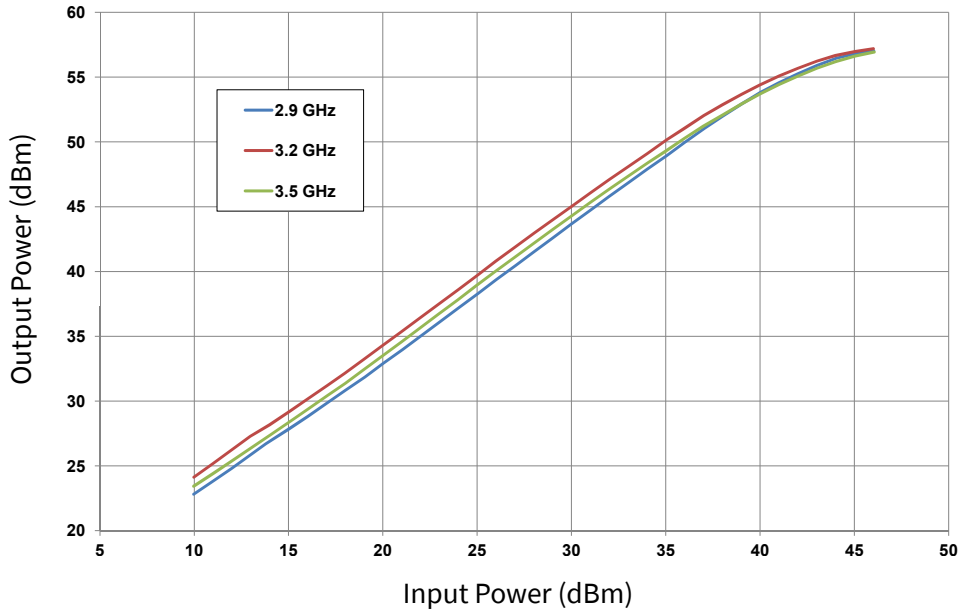
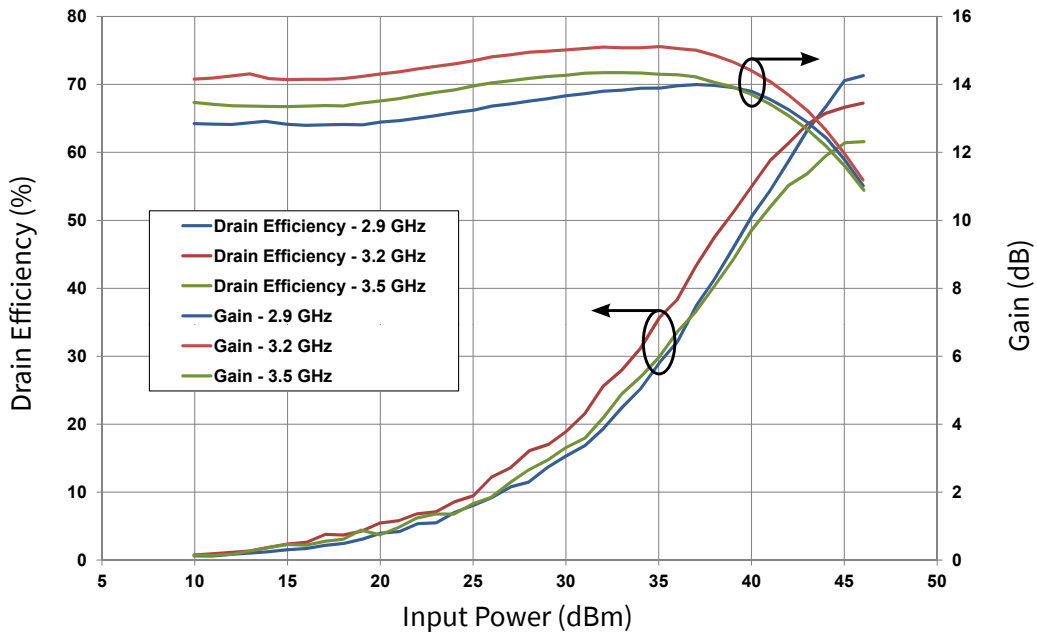

Figure 4. CGHV35400F Drain Efficiency & Gain vs Input Power
 $V_{DD} = 50\text{ V}$, $I_{DQ} = 500\text{ mA}$, Pulse Width = $500\ \mu\text{s}$, Duty Cycle = 10%, $T_{case} = 25\text{ }^\circ\text{C}$





CGHV35400F-AMP Application Circuit Bill of Materials

Designator	Description	Qty
R1	RES, 511, OHM, +/- 1%, 1/16W, 0603	1
R2	RES, 5.1, OHM, +/- 1%, 1/16W, 0603	1
C1	CAP, 6.8pF, +/-0.25%, 250V, 0603	1
C2, C7, C8	CAP, 10.0pF, +/-1%, 250V, 0805	3
C3	CAP, 10.0pF, +/-5%, 250V, 0603	1
C4, C9	CAP, 470pF, 5%, 100V, 0603, X	2
C5	CAP, 33000 pF, 0805, 100V, X7R	1
C6	CAP, 10uF 16V TANTALUM	1
C10	CAP, 1.0uF, 100V, 10%, X7R, 1210	1
C11	CAP, 33uF, 20%, G CASE	1
C12	CAP, 3300uF, +/-20%, 100V, ELECTROLYTIC	1
J1,J2	CONN, SMA, PANEL MOUNT JACK, FL	2
J3	HEADER, RT>PLZ, 0.1CEN LK 9POS	1
J4	CONNECTOR; SMB, Straight, JACK, SMD	1
W1	CABLE, 18 AWG, 4.2	1
-	PCB, RO4350, 2.5 X 4.0 X 0.030	1
Q1	CGHV35400F	1

CGHV35400F Power Dissipation De-rating Curve

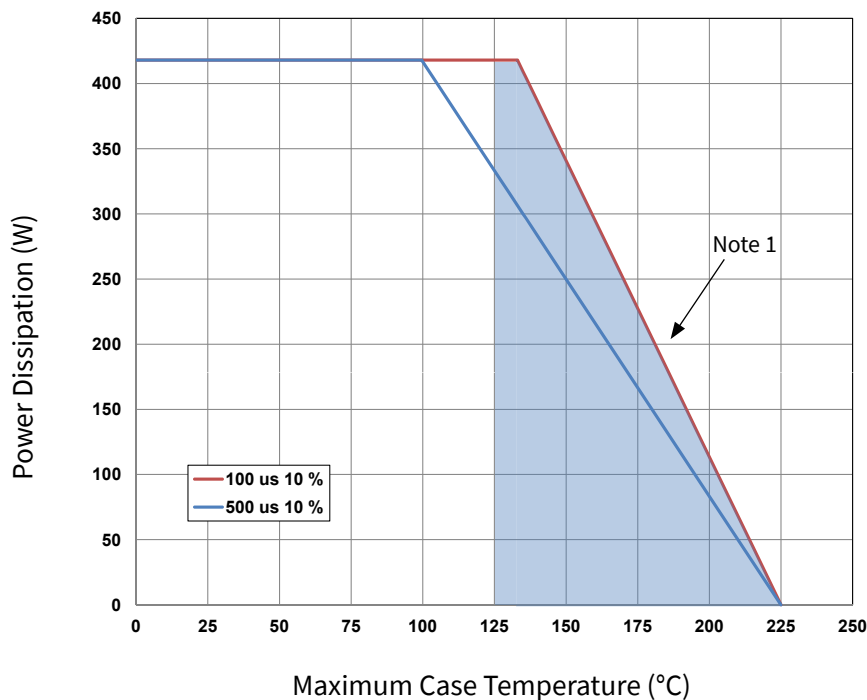

Note 1. Area exceeds Maximum Case Operating Temperature (See Page 2).



CGHV35400F-AMP Application Circuit Outline

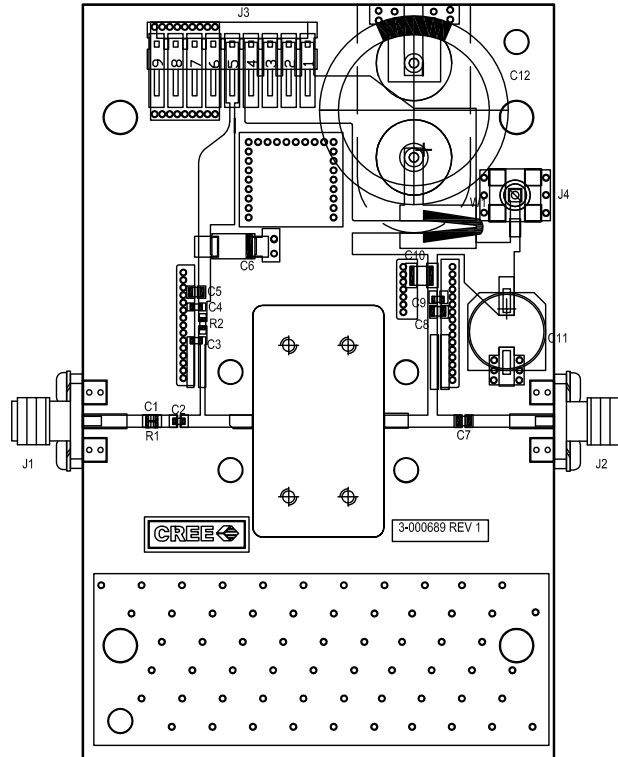

CGHV35400F-AMP Application Circuit Schematic

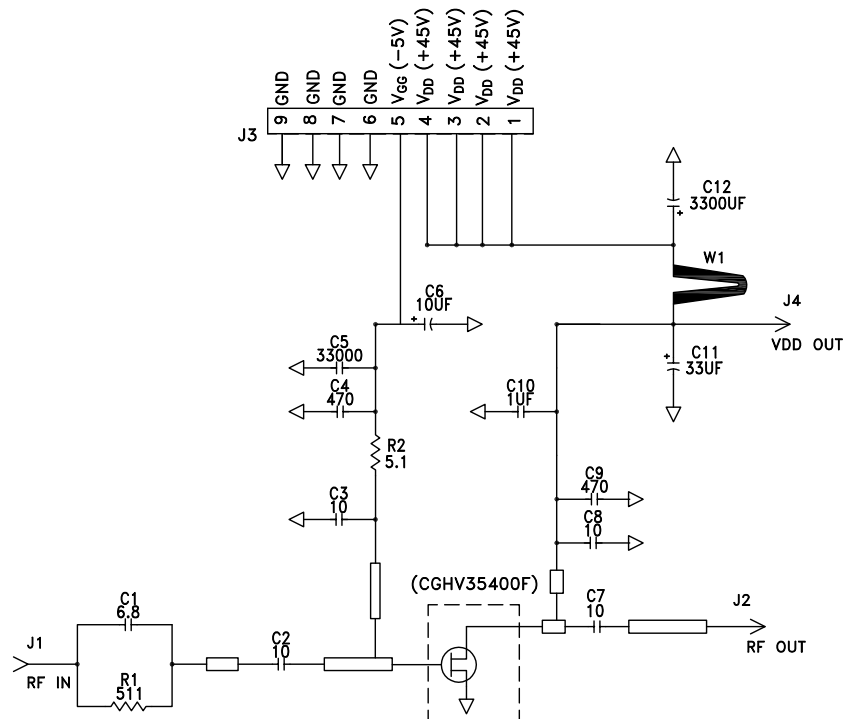



Product Dimensions CGHV35400F (Package Type — 440225)

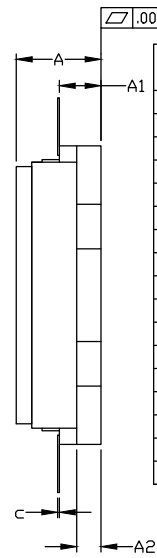
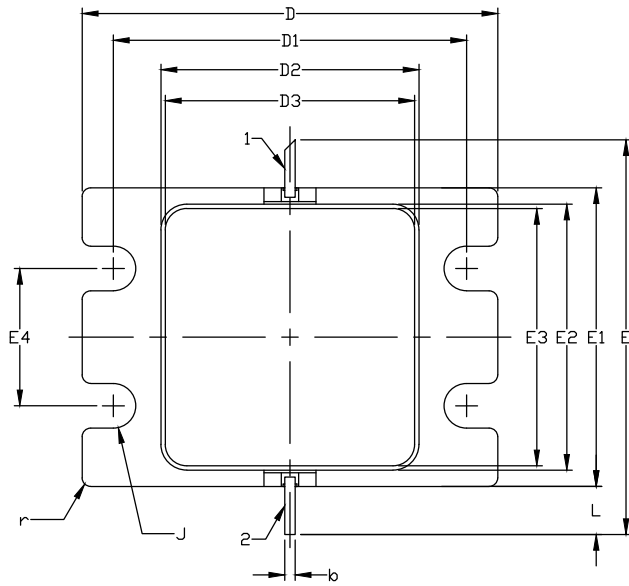

1. GATE
2. DRAIN

DIM	INCHES		MILLIMETERS		NOTES
	MIN	MAX	MIN	MAX	
A	0.185	0.201	4.70	5.11	
A1	0.088	0.100	2.24	2.54	2x
A2	0.049	0.061	1.24	1.55	
b	0.022	0.026	0.56	0.66	2x
c	0.003	0.006	0.08	0.15	
D	0.935	0.955	23.75	24.26	
D1	0.797	0.809	20.24	20.55	2x
D2	0.581	0.593	14.76	15.06	
D3	0.565	0.571	14.35	14.50	
E	0.906		23.01		REF
E1	0.679	0.691	17.25	17.55	
E2	0.604	0.616	15.34	15.65	
E3	0.588	0.594	14.93	15.09	
E4	0.309	0.321	7.85	8.15	2x
J	∅0.097	∅0.107	∅2.46	∅2.72	4x
L	0.090	0.130	2.29	3.30	2x
r	0.02 TYP		0.51 TYP		12x



Part Number System

CGHV35400F

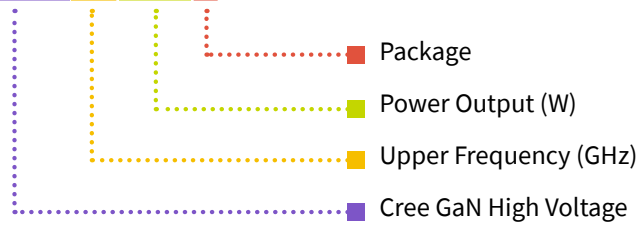

Table 1.

Parameter	Value	Units
Upper Frequency ¹	3.5	GHz
Power Output	400	W
Package	Flange	-

Note¹: Alpha characters used in frequency code indicate a value greater than 9.9 GHz. See Table 2 for value.

Table 2.

Character Code	Code Value
A	0
B	1
C	2
D	3
E	4
F	5
G	6
H	7
J	8
K	9
Examples:	1A = 10.0 GHz 2H = 27.0 GHz



Product Ordering Information

Order Number	Description	Unit of Measure	Image
CGHV35400F	GaN HEMT	Each	
CGHV35400F-AMP	Test board with GaN HEMT installed	Each	



For more information, please contact:

4600 Silicon Drive
Durham, North Carolina, USA 27703
www.wolfspeed.com/RF

Sales Contact
RFSales@cree.com

Notes

Disclaimer

Specifications are subject to change without notice. Cree, Inc. believes the information contained within this data sheet to be accurate and reliable. However, no responsibility is assumed by Cree for any infringement of patents or other rights of third parties which may result from its use. No license is granted by implication or otherwise under any patent or patent rights of Cree. Cree makes no warranty, representation or guarantee regarding the suitability of its products for any particular purpose. “Typical” parameters are the average values expected by Cree in large quantities and are provided for information purposes only. These values can and do vary in different applications and actual performance can vary over time. All operating parameters should be validated by customer’s technical experts for each application. Cree products are not designed, intended or authorized for use as components in applications intended for surgical implant into the body or to support or sustain life, in applications in which the failure of the Cree product could result in personal injury or death or in applications for planning, construction, maintenance or direct operation of a nuclear facility.