



Operating the THERMOMARK ROLL 2.0 thermal transfer printer

User manual

User manual

Operating the THERMOMARK ROLL 2.0 thermal transfer printer

UM EN THERMOMARK ROLL 2.0, Revision 01

2019-02-15

This user manual is valid for:

Designation	Revision	Order No.
THERMOMARK ROLL 2.0		1085260

Table of contents

1	For your safety	5
1.1	Identification of warning notes	5
1.2	Qualification of users	5
1.3	Field of application of the product	6
1.4	Safety notes.....	6
2	Starting up the printer	8
2.1	Unpacking and setup	8
2.2	Overview of the device	9
2.3	Connecting the device	10
2.3.1	Connecting the mains cable	10
2.3.2	Connecting the printer via USB	11
2.3.3	Connecting a printer via WLAN	12
2.3.4	Connecting a printer via Ethernet	12
2.4	Inserting the material and printing.....	13
2.4.1	Inserting the material	13
2.4.2	Inserting Leporello labels	14
2.4.3	Inserting the ink ribbon	15
2.4.4	Printing	16
2.4.5	Creating print jobs	16
3	Operating the printer	17
3.1	Touch screen display.....	17
3.1.1	Operating the display	17
3.1.2	Changing the language	17
3.1.3	Start page	18
3.2	Operation via the menu.....	19
3.3	Configuration via the website.....	27
3.4	Printing via FTP	28
3.4.1	FTP login	28
3.4.2	Sending print data via FTP	28
3.4.3	FTP access to storage media	29
3.4.4	FTP firmware update	29
4	Mounting accessories	30
4.1	Cutter or perforator	30
4.2	Mounting the external media hub.....	34

5	Maintenance and troubleshooting	35
5.1	Cleaning the device	35
5.2	Cleaning the printhead.....	36
5.3	Cleaning and replacing the pressure roller	37
5.4	Troubleshooting.....	38
5.5	Error messages	39
5.6	Repairs	40
5.7	Storage and disposal	40
A	Appendix	41
A 1	Ordering data.....	41
A 2	Technical data	44
A 3	Approvals and declarations	46
A 4	Declaration of conformity	47
A 5	Index.....	49

1 For your safety

Read this user manual carefully and keep it for future reference.

1.1 Identification of warning notes



This symbol indicates hazards that could lead to personal injury.

There are three signal words indicating the severity of a potential injury.

DANGER

Indicates a hazard with a high risk level. If this hazardous situation is not avoided, it will result in death or serious injury.

WARNING

Indicates a hazard with a medium risk level. If this hazardous situation is not avoided, it could result in death or serious injury.

CAUTION

Indicates a hazard with a low risk level. If this hazardous situation is not avoided, it could result in minor or moderate injury.



This symbol together with the **NOTE** signal word warns the reader of actions that might cause property damage or a malfunction.



Here you will find additional information or detailed sources of information.

1.2 Qualification of users

This user manual is addressed to persons, who are familiar with the relevant safety concepts for handling electrical machines. The persons must be able to recognize dangers.

1.3 Field of application of the product

The THERMOMARK ROLL 2.0 is a thermal transfer printer and thermal direct printer for the industrial sector. With this printer, you can print continuous material such as labels and shrink sleeves.

With thermal transfer printing, heat causes the color layer of an ink ribbon to be transferred onto the print medium.

The result of the print depends essentially on the suitable combination of material and ink ribbon. A low-quality ink ribbon can lead to premature wear on the printhead and result in a poor print image. Use only print materials from Phoenix Contact.

With thermal direct printing, the printer prints directly onto thermally sensitive paper. An ink ribbon is not required.

You may only use the printer with Phoenix Contact materials which are intended for the THERMOMARK ROLL 2.0. The use of other materials can result in damage to the unit.

Do not use the device at locations where children may be present.

1.4 Safety notes

Life-threatening danger from mains voltage

Never open the housing of the device.

Risk of injury

If you operate the device with the cover open, rotating parts are exposed. The moving parts can catch on loose clothing, jewelry or hair.

The device has openings that are large enough for a child's finger to fit through. Do not use the device at locations where children may be present.

Danger of crushing from cover

Make sure you do not crush yourself with the cover.

Risk of burns

During operation, the printhead can get hot. Allow the printhead to cool down before you change the material or clean the printhead line.

Hazard to operational safety

Incorrect operation or modifications to the device can endanger your safety or damage the device. Do not repair the device yourself. If the device is defective, please contact Phoenix Contact.

Damage to the device

- Only operate the device in locations that are dust-free as far as possible, dry and protected against splashwater.
- Protect the device and materials from humidity, damp, and dirt.
- Do not expose the device to direct sunlight.
- The device is equipped with a wide range power supply unit for AC voltages between 100 V and 240 V. The electrical connection conditions must comply with the details on the rating plate.

Radio interference

This is a Class A item of equipment (EN 55032). When using the equipment in residential areas, it may cause radio interference. In this case, the operator is obligated to take appropriate measures.

Notes on the printhead

The printhead is the most sensitive part of your printer. Improper handling can damage the printhead.

During printing, always make sure that there is no contamination on the material as this could be pulled underneath the printhead. This can damage the printhead.

The ink ribbon must be at least 5 mm wider than the material. Direct contact between the printhead and the material can lead to increased wear on the printhead.

2 Starting up the printer

2.1 Unpacking and setup

Scope of supply

- Printer
- Mains cable
- USB cable
- Empty film core (possibly already mounted on the take-up hub)
- Label roll EML (20X8)R/TL
- THERMOMARK-RIBBON 110/50 ink ribbon
- Data carrier with download link for the driver. The data carrier also contains this user manual in several languages.
- User manual in German and English

Unpacking

- Check the device for damage which may have occurred during transport.
- Retain the original packaging for subsequent transport.



When transporting the printer, you must remove the ink ribbon and the label material.

Requirements for the installation location



NOTE: Damage to the device

Only operate the device in locations that are dust-free as far as possible, dry and protected against splashwater. Protect the device and materials from humidity, damp, and dirt. Do not expose the device to direct sunlight.

- Place the device on a level surface.

2.2 Overview of the device

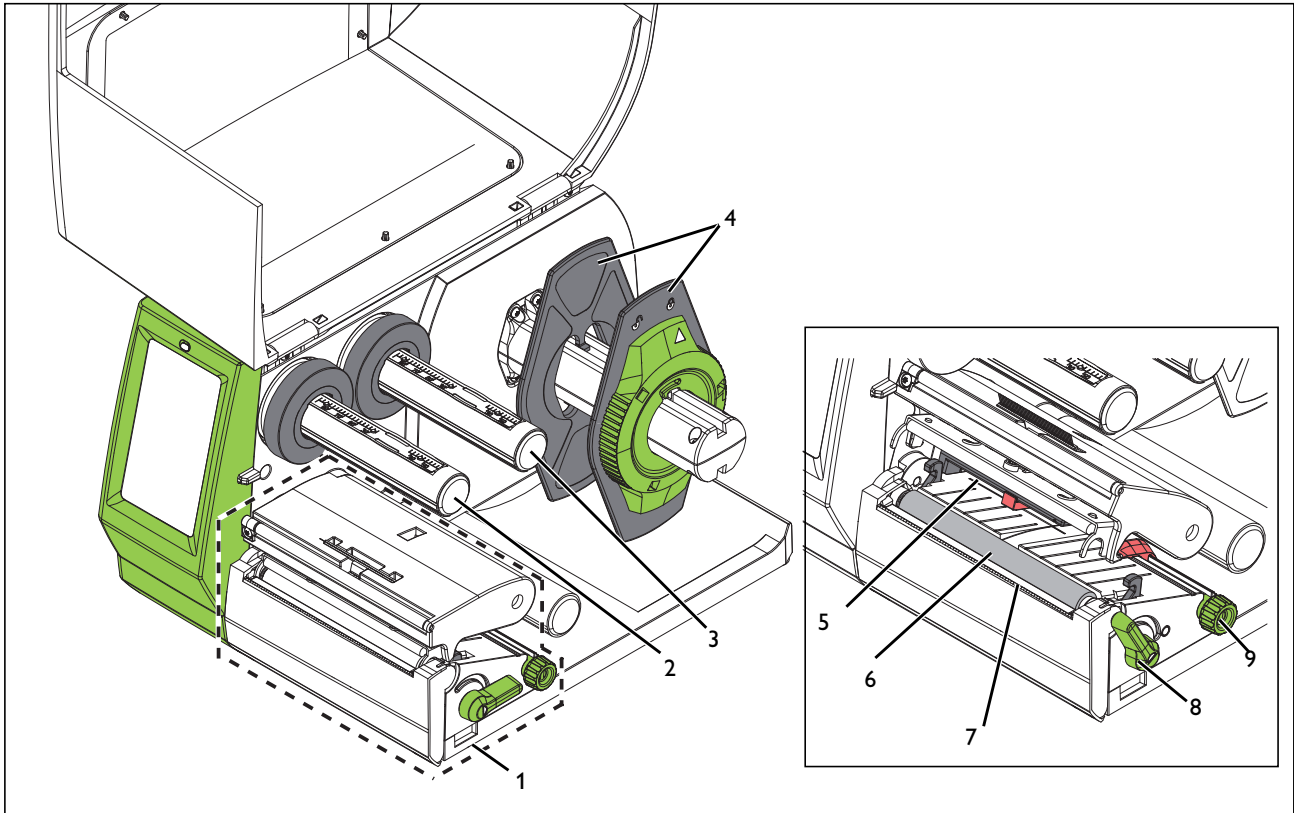

Figure 2-1 Overview

- 1 **Printing unit**
- 2 **Take-up hub**, for winding the ink ribbon
- 3 **Supply hub**, for supplying the ink ribbon
- 4 **Margin stop**, for securing the material roll
- 5 **Photoelectric barrier**, for label detection
- 6 **Pressure roller**
- 7 **Tear-off plate**
- 8 **Lever**, for locking the printhead
- 9 **Rotary dial**, for setting the material guide margin stop

2.3 Connecting the device

Mains and computer connections

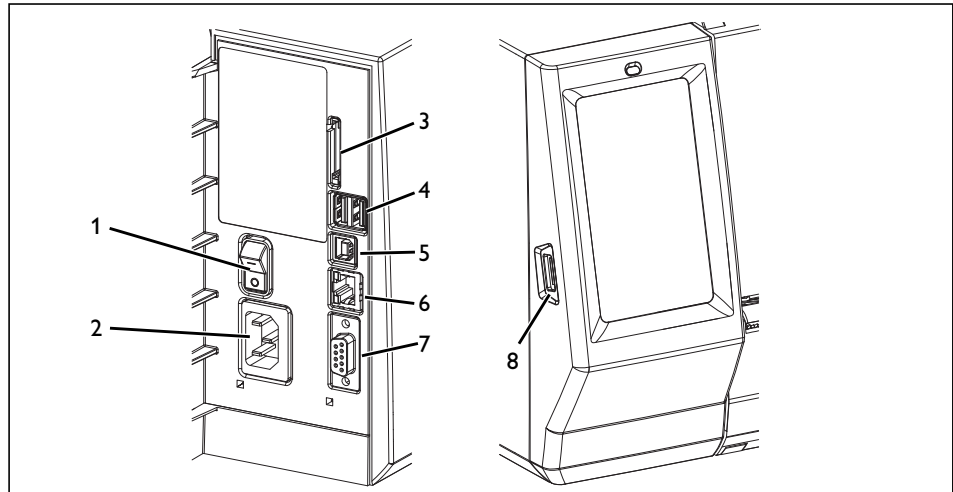

Figure 2-2 Connections on the rear of the device

- 1 Power supply switch
- 2 Mains socket
- 3 SD card slot
- 4 Two USB master interfaces for keyboard, scanner, USB memory device and WLAN stick
- 5 USB slave interface, full-speed, for connection to a computer
- 6 Ethernet 10/100Base-T
- 7 RS-232 interface
- 8 USB master interface for keyboard, scanner, USB memory device, WLAN stick and Bluetooth adapter

Errors can occur during operation due to insufficient or missing grounding. Make sure that all devices and cables connected to the printer are grounded.

Before connecting or disconnecting devices or cables, switch off the printer and the connected devices. USB connections can be established and disconnected when the printer is switched on.

2.3.1 Connecting the mains cable

The THERMOMARK ROLL 2.0 is equipped with a wide range power supply unit for AC voltages between 100 V and 240 V.

- Insert the mains cable into the socket of the device.
- Connect the mains cable to a socket.

2.3.2 Connecting the printer via USB

**NOTE: Malfunctions during operation due to insufficient or missing shielding**

Ensure that all the cables connected to the device are shielded.

A driver must be installed in order to operate the printer. The driver can be found on the Internet at phoenixcontact.net/qr/1085260.

- Switch on the computer.
- Exit all programs that are currently running.
- Switch on the device.
- Connect the computer to the device using the supplied USB cable.
- Download and install the driver software.

Following successful installation, an icon for the THERMOMARK ROLL 2.0 appears in the Windows “Devices and Printers” system folder.

- Open the marking software.
 - CLIP PROJECT can be downloaded at phoenixcontact.net/qr/5146053.
 - PROJECT complete can be downloaded at phoenixcontact.net/qr/1050453.

CLIP PROJECT marking

- Open “File, Print setup...” and create a new device under “Thermo, THERMOMARK ROLL 2.0”.
- Set up the device in the marking software.
You can find CLIP PROJECT marking instructions at phoenixcontact.net/qr/5146040.

PROJECT complete marking

- Open “File, Printer Configurations” and select the THERMOMARK ROLL 2.0 printer in the “New” field.
- Select the THERMOMARK ROLL 2.0 from the field with available printers.
- Set up the device in the marking software.

2.3.3 Connecting a printer via WLAN

Installing a WLAN stick

- Insert a WLAN stick into the USB interface to the left of the display.

Setting up the WLAN connection

- Activate the WLAN interface via the menu (see [“Setting up WLAN”](#) on [page 22](#)).
- Select Access Point. The search for available access points starts. The available access points, including hidden access points, are shown on the display.
- Select the access point. To use a hidden access point, enter its SSID.
- Assign an IP address with subnet mask and gateway or select DHCP.
When you configure a WLAN connection via the website, do not change the “IP” and “Gateway” parameters. Otherwise, the connection to the printer is interrupted.
- For protected networks, the network key is requested. Enter the network key. The connection is established. The network name and IP address are displayed.

2.3.4 Connecting a printer via Ethernet

To connect a printer via the Ethernet interface, use a cable with RJ45 connectors and the 10Base-T or 100Base-T transmission standard. Use a shielded cable.

- Connect the printer to a network socket or a computer.
- Set up the Ethernet interface via the menu (see [“Setting up Ethernet”](#) on [page 22](#)).

When you configure a WLAN connection via the website, do not change the “IP” and “Gateway” parameters. Otherwise, the connection to the printer is interrupted.

2.4 Inserting the material and printing

2.4.1 Inserting the material

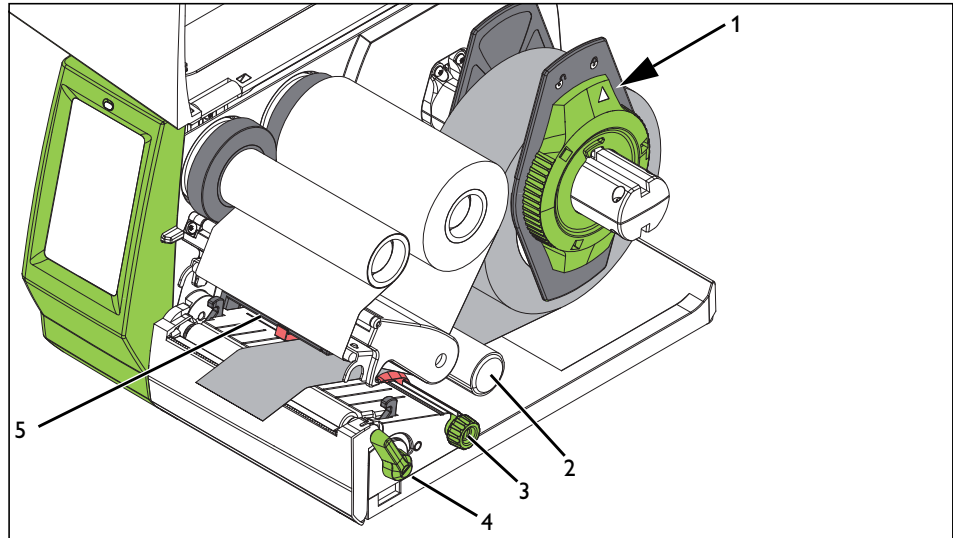



Figure 2-3 Inserting material off the roll

Inserting the material roll

- Open the cover.
- Release the margin stop (1). To do this, turn the green adjustable ring counterclockwise until the arrow points to the  symbol.
- Pull the margin stop off the media hub.
- Push the material roll onto the media hub in such a way that the material side to be printed faces upwards.
- Put the margin stop back on. Push it until both margin stops are touching the material roll. Here, a definite resistance can be felt when pushing.
- Clamp down the margin stop. To do this, turn the adjustable ring clockwise until the arrow points to the  symbol.
- Unwind a lengthy strip of the material.

Inserting material in the printhead

- To lift the printhead, turn the green lever (4) counterclockwise.
- Turn the green knurled screw (3) until the material fits between the red guides.
- Push the material below the guide roller (2) towards the printing unit. Guide the material through below the label sensor (5).
- Move the guides close to the edges of the material. The material must not become jammed.
- To close the printhead, turn the green lever clockwise.

2.4.2 Inserting Leporello labels

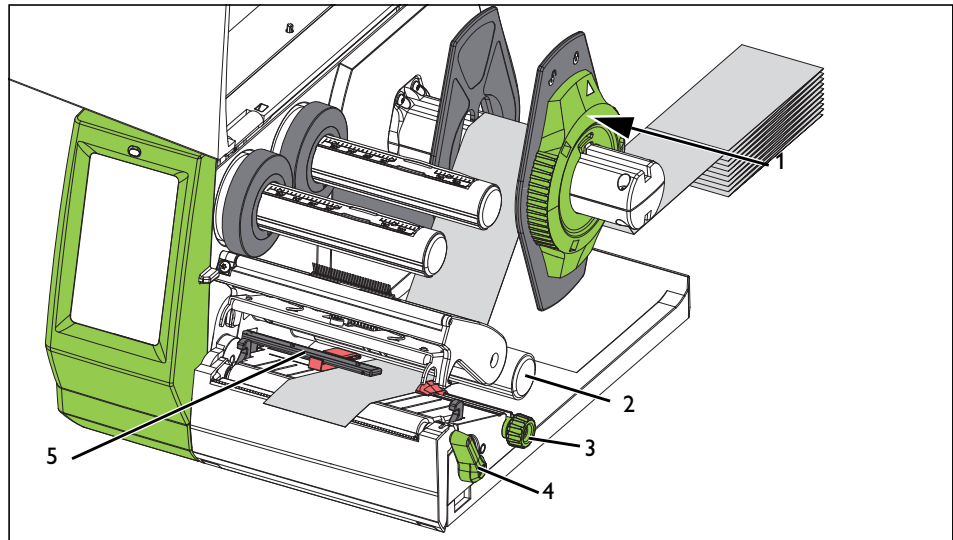



Figure 2-4 Material feed path with Leporello labels

Inserting Leporello labels

- Open the cover.
- Release the margin stop (1). To do this, turn the green adjustable ring counterclockwise until the arrow points to the  symbol.
- Position the margin stop in such a way that the material fits between the two margin stops.
- Place the label stack behind the printer. Make sure that the material side to be printed is facing upwards.
- Guide the Leporello labels over the holder for the material roll.
- Check the position of the margin stop. The material must make contact on both sides but must not jam.
- Clamp down the margin stop. To do this, turn the adjustable ring clockwise until the arrow points to the  symbol.

Inserting material in the printhead

- To lift the printhead, turn the green lever (4) counterclockwise.
- Turn the green knurled screw (3) until the material fits between the red guides.
- Push the material below the guide roller (2) towards the printing unit. Guide the material through below the label sensor (5).
- Move the guides close to the edges of the material. The material must not become jammed.
- To close the printhead, turn the green lever clockwise.

2.4.3 Inserting the ink ribbon

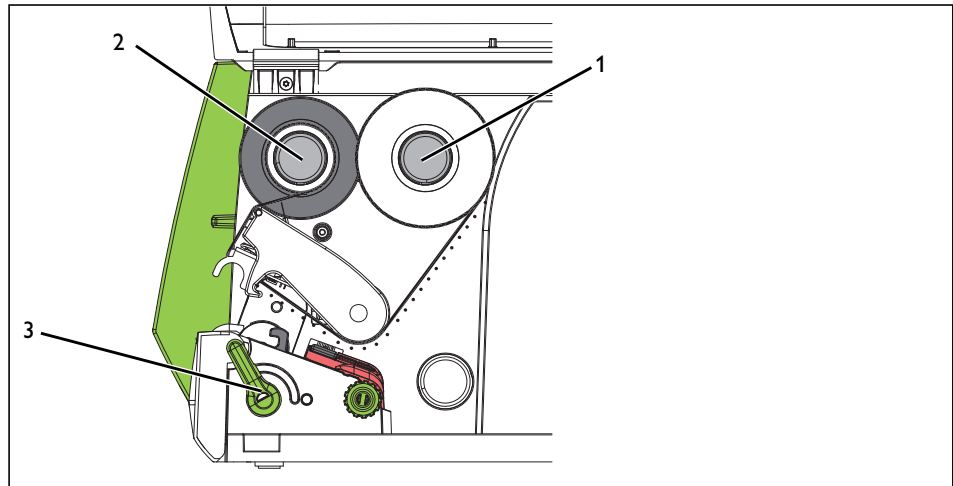

Figure 2-5 Feed path of the ink ribbon

The ink ribbon is only required for **thermal transfer printing**. Clean the printhead before inserting the ink ribbon (see [“Cleaning the printhead”](#) on page 36).

Inserting the ink ribbon

- To lift the printhead, turn the green lever (3) counterclockwise.
- Push the ink ribbon roll onto the supply hub (1) so that the color coating of the film faces downwards during unwinding.
- The Phoenix Contact ink ribbon rolls for this printer have the color coating on the outside of the winding. Observe the unwinding direction shown in [Figure 2-5](#). **If the color coating is positioned incorrectly, the film will stick to the printhead.**
- Push the empty core of an ink ribbon roll onto the take-up hub (2).
- Guide the ink ribbon through the printing unit as shown in [Figure 2-5](#). Guide the ink ribbon through above the label sensor.
- Secure the starting end of the ink ribbon centrally on the empty core of the ink ribbon roll using adhesive tape. Observe the counterclockwise running direction of the take-up hub.
- To tighten the feed path of the ink ribbon, turn the take-up hub counterclockwise.
- To close the printhead, turn the green lever clockwise.

2.4.4 Printing

The THERMOMARK ROLL 2.0 is ready for operation once all connections have been established, the material and ink ribbon have been inserted, and the printhead is locked.

Tear-off plate

After printing, the material strips are detached by hand. The printer is equipped with a tear-off plate for this purpose.

Cutter or perforator

A cutter which automatically cuts off labels is available as an accessory (THERMOMARK ROLL-CUTTER, 5146422).

A perforator is available for shrink sleeves (THERMOMARK ROLL-CUTTER/P, 5146435).

For installation see “Cutter or perforator” on [page 30](#).

2.4.5 Creating print jobs

Create the print jobs using the CLIP PROJECT or PROJECT complete marking software.

The marking software can be used to create markings on the computer that are adapted to the Phoenix Contact marking material.

Select the THERMOMARK ROLL 2.0 as the output device there. You will be provided with a list of materials that are suitable for this device.

- CLIP PROJECT can be downloaded at phoenixcontact.net/qr/5146053.
- PROJECT complete can be downloaded at phoenixcontact.net/qr/1050453.

3 Operating the printer

3.1 Touch screen display

You can change the basic settings of the printer via the touch screen display, for example:

- Pause, continue or cancel print jobs
- Configure interfaces
- Set language and time
- Update the firmware



Use only CLIP PROJECT or PROJECT complete software to modify print jobs.

3.1.1 Operating the display

- To select a menu item, briefly touch the corresponding icon.
- Move your finger up and down the display to scroll through lists.

3.1.2 Changing the language

The language is set when the printer is started up. To select a different language later, proceed as follows:



- Touch this icon.



- Touch this icon.



- Touch this icon.



- Touch this icon.
- Touch the desired language.

3.1.3 Start page

Not always are all icons visible. An icon is hidden if it is not used in the current printer status.



Call the menu



Pause print job



Continue print job



Repeat last page printed









Delete all print jobs



Feed an empty label

3.2 Operation via the menu

Table 3-1 Menu structure

	Menu	Setting option	Default
	Printer information	Printer type, version number and firmware creation date, serial number of CPU, operating time, and number of printed labels, printed length, IP and MAC addresses	–
	Access to the storage medium	Can only be selected when an external storage medium is present If a storage medium is inserted, the following directories are created on the storage medium: /fonts, /images, /misc, /labels	–
		Open saved print jobs from the /labels directory on the external storage medium (SD card, USB stick)	–
		Create list of files available on an external storage medium (SD card, USB stick)	–
		Copy files between different storage media (SD card, USB stick)	–
		Select default storage medium Specify storage medium to be accessed via the interfaces and FTP management. For other functions, all storage media can be selected but the default storage medium is suggested first. External storage media – USB memory device – SD cards	USB memory device

THERMOMARK ROLL 2.0

Table 3-1 Menu structure









	Menu	Setting option [...]	Default	
	Settings			
		Changing printing parameters		
		Setting the heat level If the printing quality is inadequate, you can change the value. We recommend increasing or reducing the heat level via the marking software first. <ul style="list-style-type: none"> - CLIP PROJECT: at “File, Print setup...” - PROJECT complete: at “File, Printer Configurations” You will find the “Printer parameters” under THERMOMARK ROLL 2.0. Only change the settings in the printer after this has been done. This will result in an additional increase or reduction.	0	
		Moving the print position horizontally This can also be changed via the marking software. <ul style="list-style-type: none"> - CLIP PROJECT: at “File, Print setup...” - PROJECT complete: at “File, Printer Configurations” You will find the “Printer parameters” under THERMOMARK ROLL 2.0. The values from the printer and the marking software are added.	0.0 mm	
		Moving the print position vertically This can also be changed via the marking software. <ul style="list-style-type: none"> - CLIP PROJECT: at “File, Print setup...” - PROJECT complete: at “File, Printer Configurations” You will find the “Printer parameters” under THERMOMARK ROLL 2.0. The values from the printer and the marking software are added. A negative value is only possible via the printer.	0.0 mm	
		Printing on request Off: All labels of a print job are printed without interruption. On: The next label will only be printed when the corresponding button is pressed on the touch screen.	Off 	
	Repeating the print by pressing the button There are several setting options. You can repeat the same print job or query the data again before.	Edit		

Table 3-1 Menu structure

















	Menu	Setting option [...]	Default
		Label detection	
		 <p>Changing the procedure for detecting the label sensor If you are printing with Phoenix Contact material, adjustment is not required. Continuous material is automatically detected.</p>	Gap sensor
		Warning before end of ink ribbon	
		 <p>Switching the warning that the ink ribbon is almost at its end on/off If the diameter of the ink ribbon roll falls below the value set here, a warning appears on the display. The possible setting range is indicated on the display.</p>	Off 
		Changing tear-off mode and position	
		 <p>Positioning the label material for tearing off at the tear-off plate On: After the last printed label, the label gap is positioned at the tear-off plate. Off: Label feed stops once the last label has completely passed the print line.</p>	On 
		Cutting settings Only visible when a cutter or perforator is present	
		 <p>Shifting the cutting position (reference: rear edge of label) If this value is positive, the label is transported further out of the printer.</p>	0.0 mm
		 <p>Increasing the perforation degree If this value is positive, the perforation will become deeper.</p>	0

Table 3-1 Menu structure















































	Menu	Setting option [...]	Default	
		Setting up interfaces		
		Setting up Ethernet		
			Entering the host name Unique designation for the printer in the network	
		 DHCP	DHCP, method for assigning the IP address On: Dynamic assignment of the IP address by the DHCP server Off: Direct assignment of the IP address by the operator	On 
		 IP	Entering the IP address IP address of the label printer. Only visible when no DHCP server is active	-
		 MASK	Entering the network mask Subnet mask of local network	-
			Switching on the gateway Connection between local and other networks	Off 
		Setting up WLAN		
		 Only visible when a WLAN stick is inserted		
			Activating the WLAN interface	Off 
	Search and selection of the access point to be used to establish the WLAN connection	-		
 DHCP	DHCP, method for assigning the IP address On: Dynamic assignment of the IP address by the DHCP server Off: Direct assignment of the IP address by the operator (see “Setting up Ethernet”)	On 		
		Network services		
		  HTTP	Website Activating the HTTP protocol for access to the printer-internal website (see “Configuration via the website”)	On 
		Printer behavior in case of error messages		
		 	On: After an error message, the last label is printed again Off: After an error message the next label is printed	On 
		 	In case of problems with the network connection, the printer is set to the error state Off: The printer ignores network problems	On 

Table 3-1 Menu structure

	Menu	Setting option [...]	Default
		Setting the language and country	
		 Setting the language	English
		 Setting the country Setting the country-specific date and time formats	Germany
		 Setting the keyboard layout when using an external keyboard When you select the automatic setting, the keyboard layout depends on the “ Setting the country ” parameter setting.	Automatic
		Setting the time and date	
		 Setting the time zone. The time zone is indicated with reference to UTC	UTC+1
		 Selecting the daylight savings time of a region. The time is automatically changed.	EU
		 Setting the date in DD.MM.YYYY format The print output of the date is in the format set via the “ Setting the country ” parameter.	–
	 Setting the system time in HH:MM:SS format When changing the time, ensure that the parameters for time zone, daylight savings time and date are correct. The print output of the time is in the format set via the “ Setting the country ” parameter.	–	
		Adjusting the display	
		 Adjusting the brightness of the display	8
		 Time without activity before the printer is set to energy-saving mode	5 min
	Test print		
		Test print on EML(20x8)R	–

THERMOMARK ROLL 2.0

Table 3-1 Menu structure























	Menu	Setting option [...]	Default
	Security		
		Activating PIN protection, password for protection of print parameter changes via the display (default: 0000)	Off
		Password for printing via FTP (see “Printing via FTP” on page 28) FTP login as ftpprint	print
		Password for FTP access to a storage medium, such as a USB stick, SD card, IFFS FTP login as ftpcard	card
		Password for FTP firmware update FTP login as ftpadmin	admin
	Password for setting parameters via the website Login as admin	admin	

Table 3-1 Menu structure

	Menu	Setting option [...]	Default	
	Extras			
		<p>Updating the firmware</p> <p>Copy the firmware file into the /misc directory of the storage medium. Insert storage medium into the printer. Then click on this button. Select the file with the firmware. The printer restarts after the update.</p>	-	
		<p>Saving the settings</p> <p>The current printer configuration is saved as an .xml file on a storage medium in the /misc directory.</p>	-	
		<p>Loading the settings</p> <p>The printer configuration is loaded from the /misc directory of a storage medium to the printer</p>	-	
		<p>Resetting</p> <p>With the exception of the passwords, all configuration settings are reset to the default values</p>	-	
		<p>Setting the cleaning interval</p> <p>Setting the intervals for printhead cleaning depending on the material throughput in steps of 100 m</p> <p>The “Clean printhead!” message appears on the display on two conditions:</p> <ul style="list-style-type: none"> - Material of the set length has passed the printhead. - There is an error in the material flow (e.g., end of material, end of ink ribbon) <p>As long as no error is present in the material flow, no message is displayed and the print job is continued even if the cleaning interval has expired.</p> <p>Only after you have acknowledged the “Clean printhead!” message, the error message for the error that occurred in the material flow is displayed.</p>	1000 m	
	Licenses and software libraries for third-party components used in the firmware		-	

THERMOMARK ROLL 2.0

Table 3-1 Menu structure

	Menu	Setting option [...]	Default
	Watching help videos		
		Video on how to insert the ink ribbon	–
		Video on how to insert the material	–
		Video on how to install the cutter	–
		Video on how to change the pressure roller	–
		Video on maintenance	–
		Video on firmware update	–

3.3 Configuration via the website

All the parameters which are accessible via the display can also be configured via a website. The website is included in the printer's firmware. Use a browser (e.g., Microsoft Internet Explorer or Mozilla Firefox) with activated JavaScript.

Access the website via the Ethernet or WLAN interface.

Opening the website

To configure settings via the website, you must enter "admin" as the user name and a password.

The default value for the password also is "admin".

You can change the password via the website.

- Start the browser.
- Open the website. Enter the IP address of the printer via HTTP (e.g., `http://192.168.9.10`).
A start screen appears.
- Use the mouse to click on the buttons. This way, you can operate the printer just like with the touch screen on the device.

Tabs on the website

The structure of the website corresponds to the menu structure of the printer.

- Reading the status of the printer
- Setting configuration parameters which are also accessible via the display in the "Settings" menu (see [page 20](#))
- Setting passwords
- Viewing lists of hardware and optional components
- Viewing overview of available fonts
- Opening auxiliary functions

3.4 Printing via FTP

With the File Transfer Protocol (FTP), you can manage and transfer files in the network via the Ethernet or WLAN interface. For printer management, you require an FTP program (FTP client) which supports the “binary” transfer mode. The printer acts as an FTP server.

The FTP printer management has three functions:

- Direct printing by copying from JScript files
- Management of the storage media installed on the label printer
- Firmware update

3.4.1 FTP login

To establish an FTP connection, the client must be logged in to the server. The type of login depends on the client. You must enter the following information in any case:

- IP address of the printer
- User name and password

Access to the printer management functions depends on the user name:

Table 3-2 Default passwords

Function	User name	Default password ¹
Printing via FTP	ftpprint	print
Access to storage medium via FTP	ftpcard	card
Firmware update via FTP	ftpadmin	admin

¹ Change the passwords via the printer menu (see [page 24](#))

After logging in, you can access the FTP server in the same way you would access a Windows folder.

3.4.2 Sending print data via FTP

You can print the print data in JScript format via an FTP connection.

- Establish an FTP connection to the printer with the user name ftpprint and the specified password (default: print). An empty folder of the FTP server is displayed.
- Copy the label file in JScript format into the folder of the FTP server.
Printing of the label file starts immediately. After the print job is complete, the associated file is automatically deleted.
- End the FTP connection.

3.4.3 FTP access to storage media

Via FTP, you can edit files that are available on an installed storage medium.

- Establish an FTP connection to the printer with the user name ftpcard and the specified password (default: card).
The content of the storage medium is displayed. The files are divided into several subfolders according to the file type.
- Edit the files as necessary. When you copy files onto the FTP server, the files are automatically sorted into subfolders according to file type.
- End the FTP connection.

3.4.4 FTP firmware update

You can update the firmware via FTP.

- Establish an FTP connection to the printer with the user name ftpadmin and the specified password (default: admin). An empty folder of the FTP server is displayed
- Copy a valid firmware file (e. g., 500_6714.cfw) into the folder of the FTP server.
While the firmware is being copied, a progress indicator appears on the display. Once the file is successfully copied, the printer restarts automatically.
- End the FTP connection.

In the status display, you can check whether the firmware update was successful.

4 Mounting accessories

4.1 Cutter or perforator

A cutter which automatically cuts off labels is available as an accessory (THERMOMARK ROLL-CUTTER, 5146422).

A perforator is available for shrink sleeves (THERMOMARK ROLL-CUTTER/P, 5146435).



WARNING: Danger of cutting due to unintentional blade movement

Disconnect the printer from the power supply before installing, removing, or cleaning the cutter blade.

Removing the tear-off plate

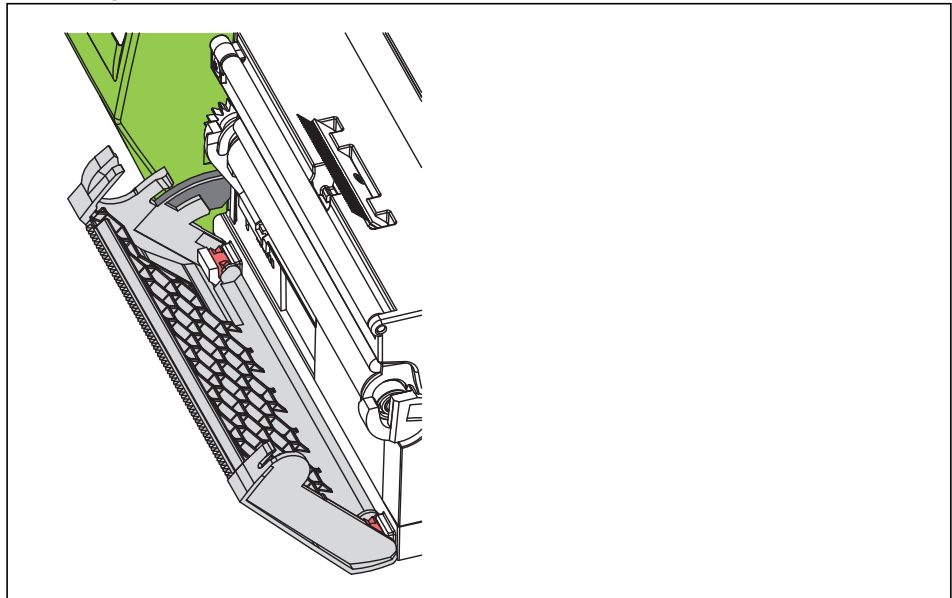

Figure 4-1 Removing the tear-off plate

- Flip open the panel with the tear-off plate so that the groove on the latching hook is visible.
- Pull the panel up out of the holder.

Mounting the cutter or perforator

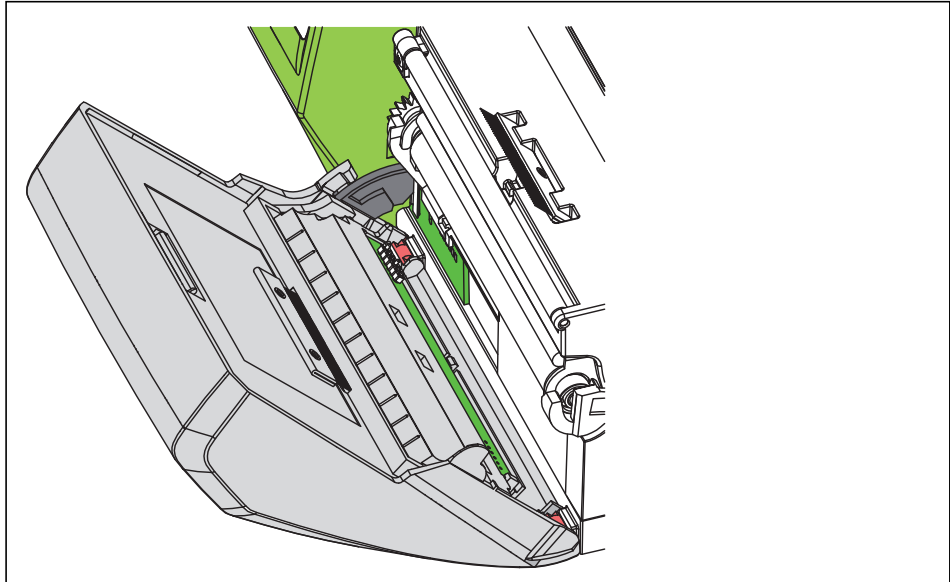

Figure 4-2 Mounting the cutter or perforator

- Insert the cutter latching hook with the groove first into the guide on the carrier.
- Press the cutter downwards into the holders.
- Flip the cutter such that it snaps into place on both sides of the carrier.



Activate the cutter or perforator in the marking software.

- CLIP PROJECT: at "File, Print setup..."
- PROJECT complete: at "File, Printer Configurations"
- You will find the "Printer parameters" with the "Accessory mode" under THERMOMARK ROLL 2.0.

Cleaning the cutter or perforator

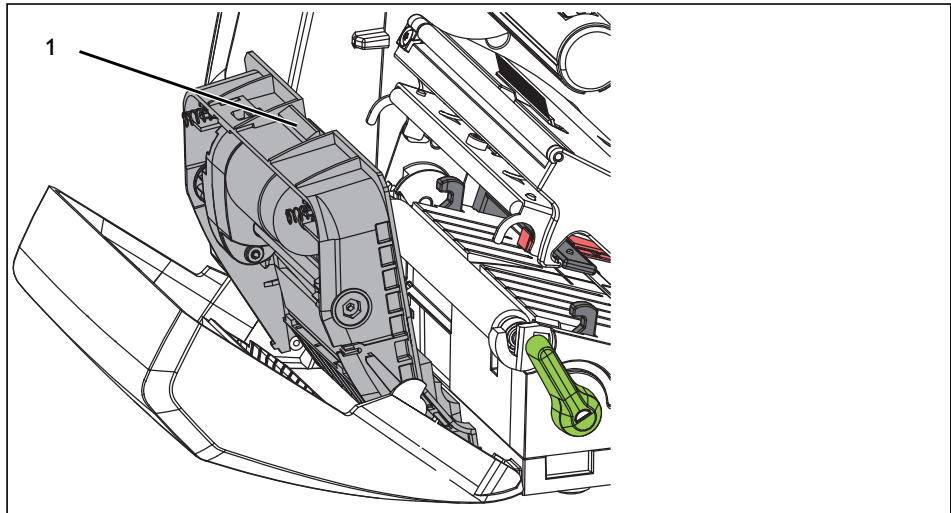

Figure 4-3 Removing the cutter blades



WARNING: Danger of cutting due to unintentional blade movement

Disconnect the printer from the power supply before installing, removing, or cleaning the cutter blade.



WARNING: Danger of cutting

The cutter blades are sharp.

- Swivel the cutter or perforator away.
- Actuate the release button (1). Take the blade assembly out of the panel.
- If the blades are soiled only slightly, clean them with a soft cloth.
- If the blades are heavily soiled with adhesive, the blades must be removed (see [“Removing the blades”](#) on [page 33](#)).
- Hook the blade assembly into the axes. Swivel the blade assembly in the panel until it snaps into place.
- Swivel the cutter towards the printer.

Removing the blades

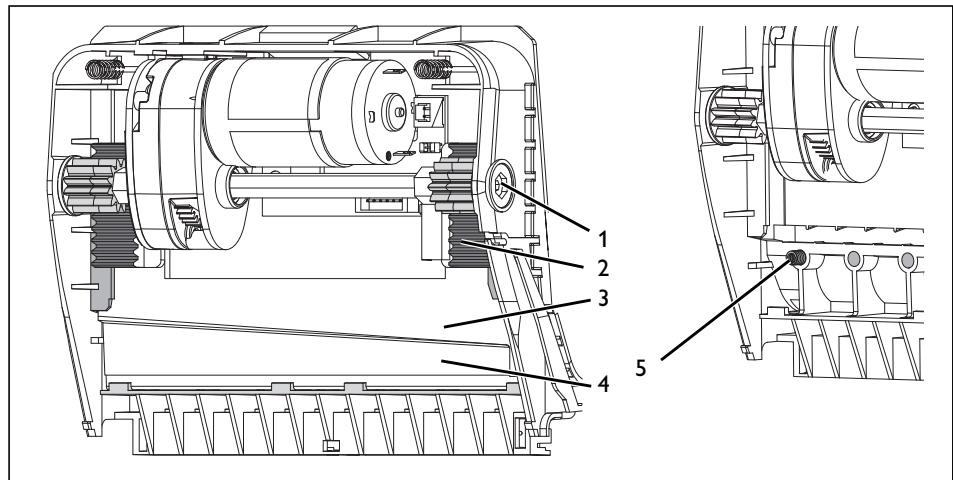

Figure 4-4 Removing the blades



WARNING: Danger of cutting

The cutter blades are sharp.

- Rotate the shaft (1) clockwise using a TX10 Torx screwdriver until the gear racks (2) are disengaged.
- Pull the upper blade (3) out of the guides.
- Remove the lower blade (4).
- Remove any deposits on the blades using a cloth dampened with label remover.
- Push the lower blade into the holders from above.
- If necessary, place the springs (5) back in the spring pockets.
- To insert the upper blade, push the lower blade onto the panel. Place the upper blade in the guide. Push it upwards until the gear racks engage with the gear wheels.
- Rotate the shaft using the Torx screwdriver until the blade reaches the upper stop.

4.2 Mounting the external media hub

An external media hub on which rolls with a larger diameter can be mounted is available as an accessory.

- **External media hub**, for roll diameters of 150 mm to 400 mm:
THERMOMARK ROLL-ERH, 5146448

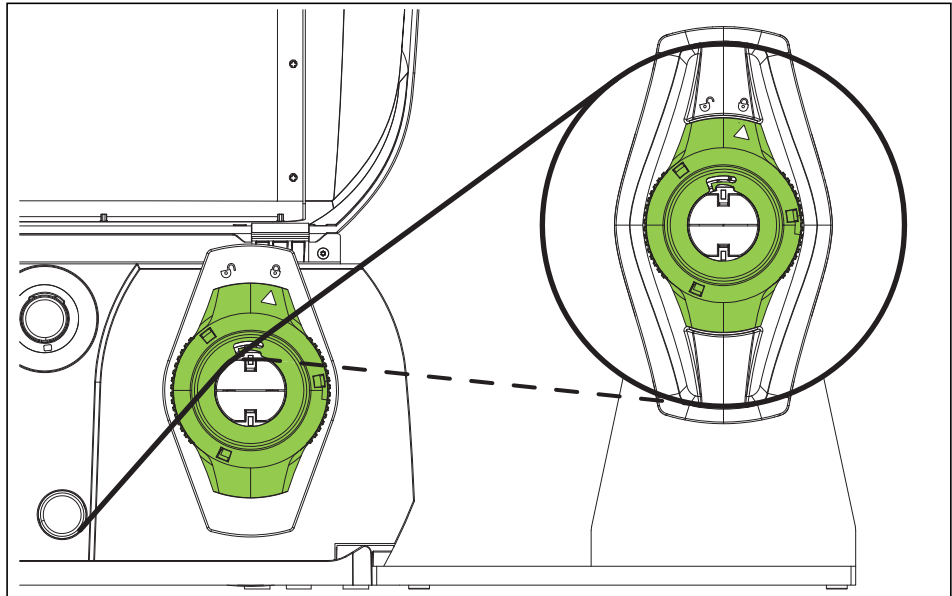



Figure 4-5 Inserting material into an external media hub

Mounting the supply hub

- Position the media hub behind the printer.
- Lift the printer slightly. Place the base onto the two hooks of the media hub.

Inserting material

- Turn the adjustable ring with the arrow to the  symbol. Pull the margin stop from the media hub.
- Push the material roll onto the media hub in such a way that the material side to be printed faces upwards.
- Put the margin stop back on. Push it onto the material roll up to the stop.
- Turn the adjustable ring with the arrow to the  symbol. By doing so, the margin stop is clamped onto the media hub.
- Adjust the printer margin stop to the width of the material.
- Guide the material over the printer media hub to the printing unit.

5 Maintenance and troubleshooting

**DANGER: Risk of electric shock**

Disconnect the device from the power grid before carrying out any maintenance work.

5.1 Cleaning the device

- Protect the device from dust and other contaminants. If the device is not used, cover it.
- Wipe down the device with a duster. The duster can either be dry or dampened with a mild cleaning agent.
- Remove dust and paper fluff in the printing area with a soft brush or vacuum cleaner.
- It is important to clean the printhead regularly. This ensures consistently good printing and reduces wear on the printhead.
- We recommend to clean the printer once a month.

5.2 Cleaning the printhead

Cleaning periods

- Thermal direct printing: after each material roll change
- Thermal transfer printing: after each ink ribbon change

After a certain amount of material flow, a message on the display indicates that the printhead should be cleaned (see “Setting the cleaning interval” on page 25).

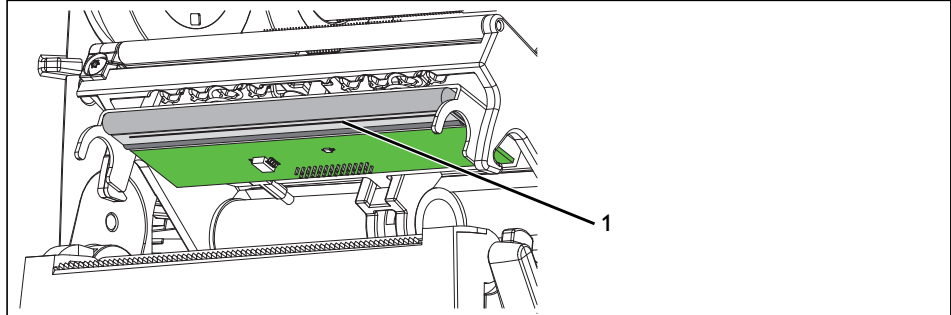

Figure 5-1 Cleaning the printhead line

During printing, impurities can collect on the printhead and reduce the print quality.



WARNING: Risk of burns

During operation, the printhead can get hot. Allow the printhead to cool down before you change the material or clean the printhead line.



NOTE: Damage to the printhead

Do not use sharp items (knives, screwdrivers etc.) to clean the printhead.

The printhead has a protective layer in the lower front area. Do not touch this protective layer with your hand.

Do not touch the printhead line.

Switch off the device.

- Make sure the print mechanism has cooled down.
- To lift the printhead, turn the green lever counterclockwise.
- Remove the material and the ink ribbon from the printer.
- Clean the printhead line (1) with a cotton bud soaked in alcohol. You can also use a cleaning stick (CLEANING STICK, 5146697).
- Let the printhead dry for 2 to 3 minutes.

5.3 Cleaning and replacing the pressure roller

Impurities on the pressure roller can impair the printing and material transport performance. Poor quality printing may result if the pressure roller is damaged or worn. In this case, you must replace the pressure roller.



Large amounts of sleeve material being processed may lead to constrictions in the pressure roller. Constrictions over the width of the sleeve material occur. In this area, there might be dropouts in the printing of labels. The pressure roller often recovers after approximately 24 hours.

We recommend using separate pressure rollers for sleeve material and for labels.

- Pressure roller, standard, TRM-PRESSURE ROLLER STANDARD, 0804655
- Pressure roller for sleeve material, TRM-PRESSURE ROLLER 4-50, 0804656

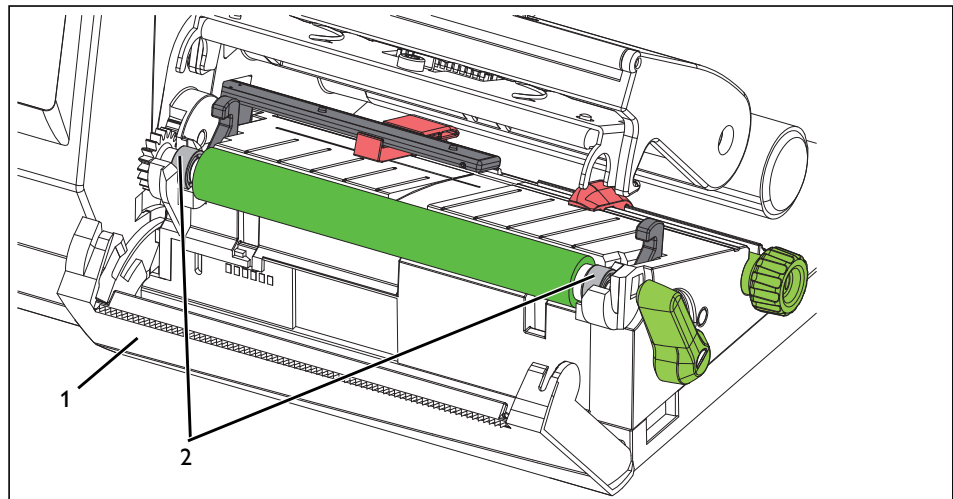

Figure 5-2 Pressure roller

Removing and installing the pressure roller

- If a cutter or perforator is installed, remove it.
- To lift the printhead, turn the green lever counterclockwise.
- Remove the material and the ink ribbon from the printer.
- Flip open the panel (1) with the tear-off plate.
- Lift the pressure roller out of the two holders (2). To do so, first strongly pull up the side with the gear.
- Remove the pressure roller.
- Clean the pressure roller using a roller cleaner, or replace it. Do not use any sharp objects to clean the pressure roller.
- Push the pressure roller with bearings into the holders until it snaps into place.
- Flip in the panel.

5.4 Troubleshooting

Table 5-1 Troubleshooting

Problem	Cause	Remedy	Page
Ink ribbon wrinkles	Feed path of the ink ribbon	Check the ink ribbon path Check the horizontal position of the ink ribbon on the take-up hub and supply hub	15
Print image is blurred or missing in places	Printhead is dirty	Clean the printhead.	36
	Pressure roller is dirty	Clean the pressure roller	37
	Pressure roller damaged	Replace the pressure roller	37
Printer transports the labels but they are not printed	Ink ribbon not inserted correctly	Clean the printhead.	36
		Insert the ink ribbon correctly	15
Printer only prints every second label	The label size defined in the marking software does not match the actual label size	Cancel the print job. Change the label format in the marking software. As an alternative, adapt the label material in the printer to the format defined in the marking software. Restart the print job.	–
Vertical white lines on the print image	Printhead is dirty	Clean the printhead.	36
	Printhead is defective	Contact Phoenix Contact	–
Print image lighter on one side	Printhead is dirty	Clean the printhead.	36

5.5 Error messages

Table 5-2 Troubleshooting

Error message	Cause	Remedy	Page
"Printhead open"	Printhead is open	Close printhead	13
"Printhead too hot"	Printhead has become overheated	The print job continues automatically after a pause	–
"Out of ribbon"	Ink ribbon used up	Insert new ink ribbon	15
	Ink ribbon torn during printing	Cancel the print job. Clean the printhead. Insert the ink ribbon. Restart the print job.	36 15
"No label found"	The label size defined in the marking software does not match the actual label size	Cancel the print job. Change the label format in the marking software. Restart the print job.	–
"Cutter jammed"	Cutter blade does not cut through material, but can return to initial position	Cancel the print job	–
		Clean the cutter blade	32
"Cutter blocked"	Cutter blade remains stuck in the material	Switch off the printer. Remove jammed material	–
	No cutter function	Switch printer off and on again. If this problem occurs again, contact Phoenix Contact.	–
"Out of paper"	Label roll or shrink sleeve has been used up	Insert material	13
	Error in material flow	Check material flow, adapt margin stops, if necessary	13
"Voltage error"	Hardware fault	Switch printer off and on again. If this problem occurs again, contact Phoenix Contact.	–
"Syntax error"	Printer has received an unknown or incorrect command	Skip command or cancel print job	–
		Check if the correct printer is set in the marking software	–

5.6 Repairs



WARNING: Hazard to operational safety

Incorrect operation or modifications to the device can endanger your safety or damage the device. Do not repair the device yourself. If the device is defective, please contact Phoenix Contact.

5.7 Storage and disposal

Transporting the device

- Remove the material and the ink ribbon.
- Pack the device in the original packaging for shipping.

Storage

- Only store the device in dry surroundings.
- Store the device in such a way as to avoid any potential damage.
- Store the device completely with individual parts and accessories. Otherwise, key components could be missing when restarting the device.

Disposal



The device contains valuable recyclable materials, which should be utilized. The electronic circuit board is fitted with a lithium battery.

A Appendix

A 1 Ordering data

Thermal transfer printer

Description	Type	Order No.	Pcs./Pkt.
Thermal transfer printer for labels and shrink sleeves, including connecting cables, 300 dpi	THERMOMARK ROLL 2.0	1085260	1

Accessories

Description	Type	Order No.	Pcs./Pkt.
Cutter	THERMOMARK ROLL-CUTTER	5146422	1
Perforator	THERMOMARK ROLL-CUTTER/P	5146435	1
External media hub , for roll diameters from 150 mm to 400 mm	THERMOMARK ROLL-ERH	5146448	1
Pressure roller , standard	TRM-PRESSURE ROLLER STANDARD	0804655	1
Pressure roller , for continuous shrink sleeve	TRM-PRESSURE ROLLER 4-50	0804656	1

Ink ribbon

Description	Type	Order No.	Pcs./Pkt.
Ink ribbon , length: 50 m, width: 110 mm, color: black	THERMOMARK-RIBBON 110/50	0800687	1
Ink ribbon , length: 60 m, width: 110 mm, color: white	TM-RIBBON 110 WH 100	0804661	1
Ink ribbon , length: 300 m, width: 110 mm, color: black	THERMOMARK-RIBBON 110	5145384	1
Ink ribbon , length: 300 m, width: 110 mm, color: blue	THERMOMARK-RIBBON 110 BU	0829544	1
Ink ribbon , length: 300 m, width: 110 mm, color: green	THERMOMARK-RIBBON 110 GN	0829542	1
Ink ribbon , length: 300 m, width: 110 mm, color: red	THERMOMARK-RIBBON 110 RD	0829543	1
Ink ribbon , specifically for EMT, TMT, WMTB HF, length: 300 m, width: 110 mm, color: black	THERMOMARK-RIBBON 110-WMTB HF	5148007	1
Ink ribbon , specifically for WMTB HF, length: 300 m, width: 110 mm, color: white	TM-RIBBON 110-WMTB HF WH	0802990	1
Ink ribbon , for high-temperature EML-HT labels, length: 300 m, width 110 mm, color: black	THERMOMARK-RIBBON 110-EML-HT	0800342	1

THERMOMARK ROLL 2.0

Ink ribbon

Description	Type	Order No.	Pcs./Pkt.
Ink ribbon , specifically for WMS... shrink sleeves, length: 300 m, width: 110 mm, color: black	THERMOMARK-RIBBON 110-WMSU	0801358	1
Ink ribbon , specifically for WMS... shrink sleeves, length: 300 m, width: 110 mm, color: white	THERMOMARK-RIBBON 110-WMSU WH	0801359	1
Ink ribbon , specifically for WMS... shrink sleeves, length: 300 m, width: 64 mm, color: black	THERMOMARK-RIBBON 64-WMSU	0801360	1
Ink ribbon , specifically for WMS... shrink sleeves, length: 300 m, width: 64 mm, color: white	THERMOMARK-RIBBON 64-WMSU WH	0801361	1
Ink ribbon , specifically for WMS-OT HF... marking sleeve (not shrinkable), length: 300 m, width: 25 mm, color: black	TM-RIBBON 25 BK 102	1053499	1

Materials

Description	Type	Order No.	Pcs./Pkt.
Terminal block markers			
Markers for terminal blocks , attachment method: latching into universal marker groove, latching into flat marker groove	TMT ... R		1
Marking foil for zack marker strip, attachment method: adhesive	TML (...X..)R		1
Marker strip for terminal blocks, attachment method: adhesive	SK .. (...X..)R		1

Wire marking

Cable marker , attachment method: adhesive	WML.. (...X..)R		1
Cable marker , halogen-free, attachment method: adhesive	WML HF .. (...X..)R		1
Cable marking flags	WML-FLAG .. (...X..)R		1
Insert label , attachment method: latching in marker carrier	EMT (...X..)R		1
Cable marker , attachment method: threading	WMT .. (...X..)R		1
Cable marker , attachment method: cable binder assembly	WMTB (...X..)R		1
Cable marker , halogen-free, attachment method: cable binder assembly	WMTB HF (...X..)R		1
Shrink sleeve	WMS .. (...X..)R		1
Shrink sleeve , halogen-free	WMS-2 HF .. (...X..)R		1
Marking sleeve (not shrinkable), halogen free	WMS-OT HF .. (EX..)R		1

Materials

Description	Type	Order No.	Pcs./Pkt.
Equipment marking			
Labels , attachment method: adhesive	EML(..X..)R		1
Labels for sensitive components , attachment method: adhesive	EML-ESD(..X..)R		1
Labels for rough surfaces , attachment method: adhesive	EML-HA(..X..)R		1
Labels for high-temperature applications , attachment method: adhesive	EML-HT(..X..)R		1
Removable labels , attachment method: adhesive	EML-RM(..X..)R		1
Detectable labels , attachment method: adhesive	EML-D(..X..)R		
Labels offering particular flexibility , adhesive over edges, attachment method: adhesive	EMLC(..X..)R		1
Labels offering particular flexibility , for rough surfaces, attachment method: adhesive	EMLF(..X..)R		1
Plastic label , attachment method: adhesive	EMLP(..X..)R		1
Safety label with special adhesive, attachment method: adhesive	EMLS(..X..)R		1
Insert label , attachment method: latching in marker carrier	EMT(..X..)R		1
Plant marking			
Electric circuit label , attachment method: adhesive	PML-C101 (D39)R	1032780	1
Hazardous substances label , attachment method: adhesive	PML-GHS100(..X..)R		1
Mandatory sign , attachment method: adhesive	PML-M..(..X..)R		1
Prohibition sign , attachment method: adhesive	PML-P..(..X..)R		1
Warning label , attachment method: adhesive	PML-W..(..X..)R		1
Pipeline marker , attachment method: adhesive	PML-T..(..X..)R		1
Magnetic sign , attachment method: magnetic adhesion	PMM(..X..)R		1

A 2 Technical data

Printhead	
Printing method	Thermal transfer, thermal direct
Print resolution	300 dpi x 300 dpi (12 dots/mm x 12 dots/mm)
Material sensor	
Position	Centered
Type	Transmissive sensor
Detection	Inter-label clearance, black mark and hole mark
Print speed	30 mm/s ... 150 mm/s
Print length	5 mm, minimum, 1000 mm, maximum
Print width	104 mm, maximum
Material	
Outside diameter of the label roll	152 mm, maximum
Internal core diameter	38.1 mm ... 76 mm
Ink ribbon	
Length	300 m, maximum
Outside diameter of the ink ribbon roll	68 mm, maximum
Internal core diameter	25.4 mm
Printer dimensions	
Dimensions (W x H x D)	189 mm x 320 mm x 253 mm
Weight	3.5 kg
Electronics	
High-speed processor, 32 bits, ColdFire	
Cycle rate	800 MHz
Main memory (RAM)	265 MB
Program memory (ROM)	50 MB
Slot for SD memory card (SDHC, SDXC)	Up to 512 GB

Interfaces

Serial RS-232 C	1200 to 230400 baud/8 bits
USB 2.0	High-speed slave for PC connection
USB host	2 x on the back, up to 500 mA
USB host	1 x on the control panel, up to 500 mA
Ethernet	LPD, IPv4, IPv6, RawIP printing, DHCP, HTTP, FTP, SMTP, SNMP, TIME, NTP, Zeroconf, SOAP web service

Software

Marking software	CLIP PROJECT marking advanced / professional PROJECT complete marking
------------------	---

Operating data

Voltage	100 V AC ... 240 V AC, 50/60 Hz, PFC
Power consumption	150 W, typically / 300 W, maximum
Temperature	
Operation	+5°C ... +35°C
Storage	0°C ... +60°C
Transport	-25°C ... +60°C
Humidity	
Operation	10% ... 85%, non-condensing
Storage	20% ... 80%, non-condensing
Transport	20% ... 80%, non-condensing

Approvals

Approvals	CE, FCC class A, UL, CB, CCC, KC, ICES3
-----------	---

A 3 Approvals and declarations

A 3.1 Federal Communications Commission (FCC)

NOTE: This equipment has been tested and found to comply with the limits for a Class A digital device, pursuant to Part 15 of the FCC Rules.

These limits are designed to provide reasonable protection against harmful interference when the equipment is operated in a commercial environment. The equipment generates, uses, and can radiate radio frequency and, if not installed and used in accordance with the instruction manual, may cause harmful interference to radio communications.

Operation of this equipment in a residential area is likely to cause harmful interference in which case the user may be required to correct the interference at his own expense.

A 3.2 Interference-Causing Equipment Standard (ICES)

Industry Canada Compliance Statement

This Class A digital apparatus complies with Canadian ICES-003.

CAN ICES-3 (A)/NMB-3(A)

A 3.3 GPL code

This product includes software code developed by third parties, including software code subject to the GNU General Public License ("GPL") or GNU Lesser General Public License ("LGPL"). As applicable, the terms of the GPL and LGPL, and information on obtaining access to the GPL Code and LGPL Code used in this product, are available to you at: phoenixcontact.net/products under the description of the printer.

The GPL Code and LGPL Code used in this product is distributed WITHOUT ANY WARRANTY and is subject to the copyrights of one or more authors. For details, see the GPL Code and the LGPL Code for this product and the terms of the GPL and LGPL.

Written Offer to GPL Source Code:

Whereas such specific license terms entitle you to the source code of such software, PHOENIX CONTACT will provide upon written request via email and/or traditional paper mail the applicable GPL source code files via CD-ROM for a nominal cost to cover shipping and media charges as allowed under the GPL and LGPL.

Please direct all inquiries to:

PHOENIX CONTACT GmbH & Co. KG
Flachmarktstraße 8
32825 Blomberg
DEUTSCHLAND

A 4 Declaration of conformity

The THERMOMARK ROLL 2.0 complies with the key requirements of the following directives:

- 2011/65/EU Restriction of the use for certain hazardous substances
- 2014/30/EU EMC Directive (electromagnetic compatibility)
- 2014/35/EU Low Voltage Directive

The standards consulted for evaluating conformity can be found at:

phoenixcontact.net/product/1085260

A 5 Index

C

Changing the language	17
Cleaning	
Device	35
Cleaning interval	25
Connections	10
Creating print jobs	16

D

Display	17
Disposal	40

E

Error causes	39
Error messages	39, 40
Ethernet	12
Exchanging the roller	37

F

FTP	28
-----------	----

I

Ink ribbon	
Inserting	
Ordering data	41
Inserting label strips in printhead	13, 14
Inserting labels	13
Inserting Leporello labels	14
Inserting marker sleeve	13
Inserting material	13
Inserting shrink sleeve	13
Installation location	8

O

Ordering data	41
---------------------	----

P

Pressure roller	
Exchanging	37
Printhead	
Cleaning	36
Notes	7

S

Scope of supply	8
-----------------------	---

T

Technical data	44
Transfer film, see ink ribbon	
Transport	40
Troubleshooting	39

U

Unpacking	8
-----------------	---

W

Website	27
WLAN	12

Please observe the following notes

General Terms and Conditions of use for technical documentation

Phoenix Contact reserves the right to alter, correct, and/or improve the technical documentation and the products described in the technical documentation at its own discretion and without giving prior notice, insofar as this is reasonable for the user. The same applies to any technical changes that serve the purpose of technical progress.

The receipt of technical documentation (in particular user documentation) does not constitute any further duty on the part of Phoenix Contact to furnish information on modifications to products and/or technical documentation. You are responsible to verify the suitability and intended use of the products in your specific application, in particular with regard to observing the applicable standards and regulations. All information made available in the technical data is supplied without any accompanying guarantee, whether expressly mentioned, implied or tacitly assumed.

In general, the provisions of the current general Terms and Conditions of Phoenix Contact apply exclusively, in particular as concerns any warranty liability.

This manual, including all illustrations contained herein, is copyright protected. Any changes to the contents or the publication of extracts of this document are prohibited.

Phoenix Contact reserves the right to register its own intellectual property rights for the product identifications of Phoenix Contact products that are used here. Registration of such intellectual property rights by third parties is prohibited.

Other product identifications may be afforded legal protection, even where they may not be indicated as such.

How to contact us

Internet

Up-to-date information on Phoenix Contact products and our Terms and Conditions can be found on the Internet at:

phoenixcontact.com

Make sure you always use the latest documentation.

It can be downloaded at:

phoenixcontact.net/products

Subsidiaries

If there are any problems that cannot be solved using the documentation, please contact your Phoenix Contact subsidiary.

Subsidiary contact information is available at phoenixcontact.com.

Published by

PHOENIX CONTACT GmbH & Co. KG

Flachsmarktstraße 8

32825 Blomberg

GERMANY

Should you have any suggestions or recommendations for improvement of the contents and layout of our manuals, please send your comments to:

tecdoc@phoenixcontact.com

PHOENIX CONTACT GmbH & Co. KG
Flachmarktstraße 8
32825 Blomberg, Germany
Phone: +49 5235 3-00
Fax: +49 5235 3-41200
E-mail: info@phoenixcontact.com
phoenixcontact.com

© PHOENIX CONTACT 2019-02-15

108716_en_01
Order No. — 01