



Signal converter for converting potentiometer positions to an analogue standard signal, Screw connection, Mounting type: Mounting rail TS 35, Supply voltage: 24 VDC

Business data

Article number	<u>15641.2</u>
Article name	CML-POT-UI
GTIN (EAN)	4044211207366
Packaging unit	1
Quantity unit	PC
Weight per piece (not including packaging)	55 g
Weight per piece (including packaging)	78 g
Unit of weight	G
Customs number	85423990
Country of origin	NL
Product description	Converter unit

Technical data

Dimensions

Length	93.1 mm
Width	6.2 mm
Height	102.5 mm

Ratings

Overvoltage category	III
Contamination degree	2

Connection data

Connection principle	Screw connection
Wire cross-section single core (rigid), min.	0.2 mm ²
Wire cross-section single-core (rigid), max.	2.5 mm ²
Wire cross-section stranded, min.	0.2 mm ²
Wire cross-section stranded, max.	2.5 mm ²
Wire cross-section stranded with wire-end ferrules, min.	0.2 mm ²
Wire cross-section stranded with wire-end ferrules, max.	2.5 mm ²
Stripping length	12 mm
Torque	0.6 Nm

Input data

Input signals	Poti min: 1 kOhm, Poti max: 20 kOhm -
---------------	---------------------------------------

Output data

Output signal adjustable via DIP switch	✓
Load resistance U	>1K Ohm
Load resistance I	<500 Ohm
Offset I	20 µA
Offset U	10 mV
Output signal I, max.	22 mA
Output signal U, max.	11 V

Materials

Working temperature, min.	-20 °C
Working temperature, max.	55 °C
Temperature coefficient	<0,02% °C

Technical data

Further technical data

Power supply	24 VDC -15% / +10% -
Current consumption	40 mA
Response time	100 ms
Transmission error (from end value)	<0,2%
Limit frequency (-3 dB)	10 Hz
Protection class	IP20

Environmental Product Compliance

REACH Conform	yes
REACH Reference date	2023-01-17
REACH Candidate Substance Note	No
RoHS Conform	yes

Approvals

Standards and regulations

CE compliant

yes

Standards / specifications

DIN VDE 0110 / EN 50178

Media

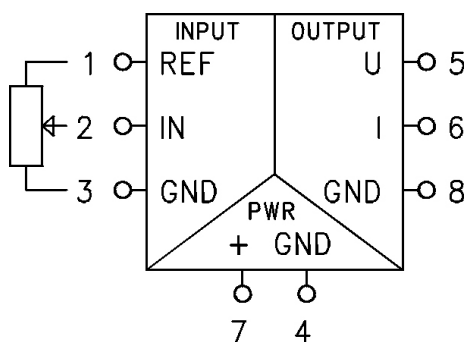

DIPSWITCH SELECTION

OUTPUT	1	2	3	4
0..10V	X	X	X	X
0..20mA	X	OFF	OFF	X
4..20mA	X	ON	ON	X

X = Don't Care

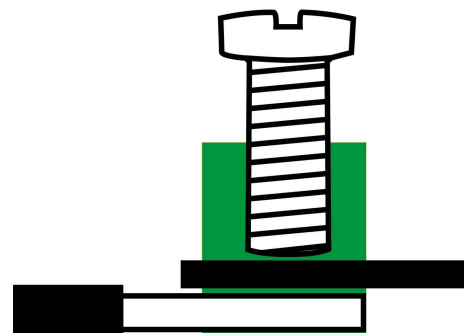

Accessories
