

## 15489.2 PRC 220...240V AC/DC

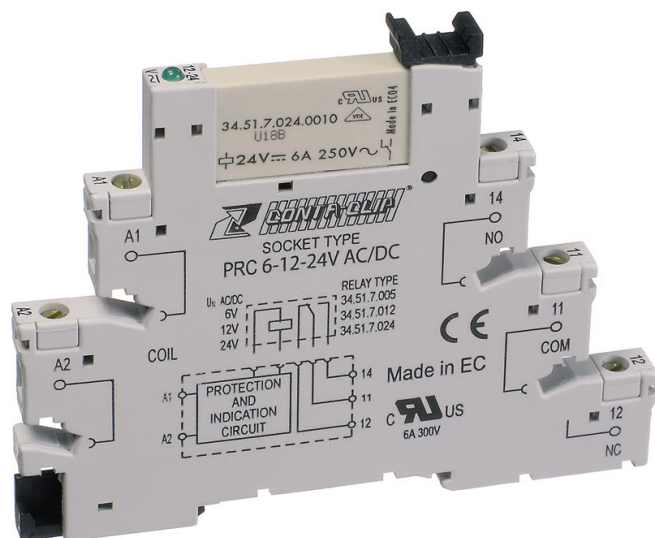

Plug-Relay-Compact (PRC) socket base PRC with screw connection, Mounting type: Mounting rail TS 35, 1 CO contact, Input voltage: 220 to 240 VAC/DC

### Business data

Article number	15489.2
Article name	PRC 220...240V AC/DC
GTIN (EAN)	4044211118259
Packaging unit	10
Quantity unit	PC
Weight per piece (not including packaging)	30.3 g
Weight per piece (including packaging)	32.32 g
Unit of weight	G
Customs number	85369010
Country of origin	IT
Product description	Relay socket base with screw connection

### Technical data

#### Dimensions

Length	87.3 mm
Width	6.2 mm
Height TS 35 / 7.5 with BA	79.9 mm

#### Ratings

Rated voltage Un	220-240 VAC/DC -
Overvoltage category	III
Contamination degree	3

#### Connection data

Connection principle	Screw connection
Wire cross-section single core (rigid), min.	0.2 mm <sup>2</sup>
Wire cross-section single-core (rigid), max.	2.5 mm <sup>2</sup>
Wire cross-section stranded, min.	0.2 mm <sup>2</sup>
Wire cross-section stranded, max.	2.5 mm <sup>2</sup>
Stripping length	10 mm
Torque	0.5 Nm

#### Output data

Switching voltage / switching voltage max.	250 / 400 VAC
Contact configuration	1 CO contact

#### Materials

Working temperature, min.	-40 °C
Working temperature, max.	70 °C

#### Further technical data

Degree of protection	IP20
Status display	✓

#### Environmental Product Compliance

REACH Conform	yes
REACH Reference date	2023-01-17
REACH Candidate Substance Note	No
RoHS Conform	yes

---

### Approvals

---

#### Standards and regulations

---

CE compliant	yes
cUL approval	CSA-C22.2 No. 14
UL approval	UL 508
UL Recognized	1
cUL Recognized	1

---

### Media

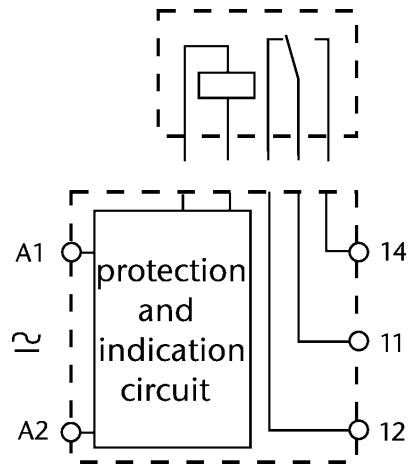
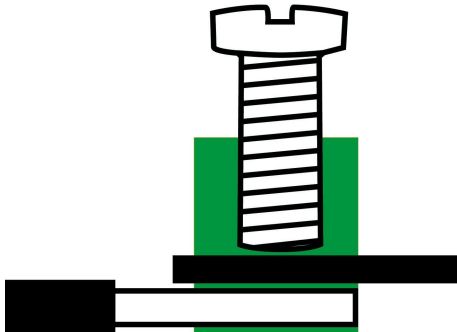

### Accessories

#### Cross-connector

External cross-connector insulated for Plug-Relay-Compact (PRC), 20-pole, can be shortened, Voltage: 250 V, Current: 36 A

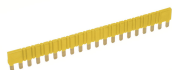

Article number	Article name	GTIN (EAN)	Packaging unit
<u>15545.8</u>	AQI/PRC/20 YE	4044211118440	1

#### Quick marking

Terminal marker / Pocket Maxicard, Length: 12 mm, Width: 6 mm, Colour: White



Article number	Article name	GTIN (EAN)	Packaging unit
<u>9107.7</u>	PMC BSTR 6/30 So WH	4044211099749	300 ST

Terminal marker / Pocket Maxicard, Length: 12 mm, Width: 6 mm, Colour: White

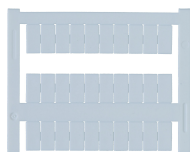

Article number	Article name	GTIN (EAN)	Packaging unit
<u>9106.7</u>	PMC BSTR 6/30 WH	4044211099732	300 ST

#### Screwdriver

Screwdriver with bare blade, Colour: Black-grey



Article number	Article name	GTIN (EAN)	Packaging unit
<u>1086.0</u>	SDB 0,6x3,5	4044211014797	1 ST

#### Relays

Plug-in miniature power relay, With power contact, 1 CO contact, Input voltage: 60 VDC



Article number	Article name	GTIN (EAN)	Packaging unit
<u>15503.2</u>	PRC 1/60V DC	4044211118167	10 ST

## 15489.2 PRC 220...240V AC/DC

### Relays



Plug-in miniature power relay, With multi-layer gold contact, 1 CO contact, Input voltage: 60 VDC

Article number	Article name	GTIN (EAN)	Packaging unit
<u>15568.2</u>	PRC 1/60V DC Au	4044211118419	10 ST

### Partition plate



Partition plate for Plug-Relay-Compact (PRC) for separating relay blocks, width: 1.5 mm

Article number	Article name	GTIN (EAN)	Packaging unit
<u>15546.2</u>	TW/PRC GR	4044211118457	1 ST