

# Product data sheet

Specifications



## softstarter-ATS22-control 110V- power 208V(40hp)/230V(40hp)/460V(10

ATS22C14S6U

### Main

Range of product	Altestart 22
Product or component type	Soft starter
Product destination	Asynchronous motors
Product specific application	Pumps and fans
Component name	ATS22
Network number of phases	3 phases
[Us] rated supply voltage	208...600 V - 15...10 %
Motor power hp	100 hp 460 V 125 hp 575 V 40 hp 208 V 50 hp 230 V
Factory setting current	124 A
Power dissipation in W	82 W for standard applications
Utilisation category	AC-53A
Type of start	Start with torque control (current limited to 3.5 In)
IcL starter rating	140 A for connection in the motor supply line for standard applications
IP degree of protection	IP00

### Complementary

Assembly style	With heat sink
Function available	Internal bypass
Supply voltage limits	177...660 V
Supply frequency	50...60 Hz - 10...10 %
Network frequency	45...66 Hz
Device connection	In the motor supply line
[Uc] control circuit voltage	110 V - 15...10 % 50/60 Hz
Control circuit consumption	20 W
Discrete output number	2
Discrete output type	Relay outputs R1 230 V running, alarm, trip, stopped, not stopped, starting, ready C/O Relay outputs R2 230 V running, alarm, trip, stopped, not stopped, starting, ready C/O
Minimum switching current	100 mA at 12 V DC (relay outputs)

<b>Maximum switching current</b>	5 A 250 V AC resistive 1 relay outputs 5 A 30 V DC resistive 1 relay outputs 2 A 250 V AC inductive 0.4 20 ms relay outputs 2 A 30 V DC inductive 7 ms relay outputs
<b>Discrete input number</b>	3
<b>Discrete input type</b>	(LI1, LI2, LI3) logic, 5 mA 20 kOhm
<b>Discrete input voltage</b>	110 V <= 121 V
<b>Discrete input logic</b>	Positive logic LI1, LI2, LI3 at State 0: < 20 V and <= 15 mA at State 1: > 79 V, <= 2 mA
<b>Output current</b>	0.4...1 Icl adjustable
<b>PTC probe input</b>	750 Ohm
<b>Communication port protocol</b>	Modbus
<b>Connector type</b>	1 RJ45
<b>Communication data link</b>	Serial
<b>Physical interface</b>	RS485 multidrop
<b>Transmission rate</b>	4800, 9600 or 19200 bps
<b>Installed device</b>	31
<b>Protection type</b>	Phase failure: line Thermal protection: motor Thermal protection: starter
<b>Marking</b>	CE
<b>Type of cooling</b>	Forced convection
<b>Operating position</b>	Vertical +/- 10 degree
<b>Height</b>	356 mm
<b>Width</b>	150 mm
<b>Depth</b>	229.5 mm
<b>Net weight</b>	18 kg

## Environment

<b>Electromagnetic compatibility</b>	Conducted and radiated emissions level A conforming to IEC 60947-4-2 Damped oscillating waves level 3 conforming to IEC 61000-4-12 Electrostatic discharge level 3 conforming to IEC 61000-4-2 Immunity to electrical transients level 4 conforming to IEC 61000-4-4 Immunity to radiated radio-electrical interference level 3 conforming to IEC 61000-4-3 Voltage/current impulse level 3 conforming to IEC 61000-4-5
<b>Standards</b>	EN/IEC 60947-4-2
<b>Product certifications</b>	C-Tick CCC CSA UL GOST
<b>Vibration resistance</b>	1 gn (f= 13...200 Hz) conforming to EN/IEC 60068-2-6 1.5 mm (f= 2...13 Hz) conforming to EN/IEC 60068-2-6
<b>Shock resistance</b>	15 gn for 11 ms conforming to EN/IEC 60068-2-27
<b>Noise level</b>	56 dB
<b>Pollution degree</b>	Level 2 conforming to IEC 60664-1
<b>Relative humidity</b>	0...95 % without condensation or dripping water conforming to EN/IEC 60068-2-3
<b>Ambient air temperature for operation</b>	-10...40 °C (without derating) 40...60 °C (with current derating 2.2 % per °C)
<b>Ambient air temperature for storage</b>	-25...70 °C
<b>Operating altitude</b>	<= 1000 m without derating > 1000...< 2000 m with current derating of 2.2 % per additional 100 m

## Packing Units

Unit Type of Package 1	PCE
Number of Units in Package 1	1
Package 1 Height	25.0 cm
Package 1 Width	33.0 cm
Package 1 Length	41.0 cm
Package 1 Weight	13.214 kg
Unit Type of Package 2	P06
Number of Units in Package 2	4
Package 2 Height	73.5 cm
Package 2 Width	80.0 cm
Package 2 Length	60.0 cm
Package 2 Weight	65.856 kg

## Offer Sustainability

Sustainable offer status	Green Premium product
REACH Regulation	<a href="#">REACH Declaration</a>
EU RoHS Directive	Pro-active compliance (Product out of EU RoHS legal scope) <a href="#">EU RoHS Declaration</a>
Mercury free	Yes
China RoHS Regulation	<a href="#">China RoHS declaration</a>
RoHS exemption information	Yes
Environmental Disclosure	<a href="#">Product Environmental Profile</a>
Circularity Profile	<a href="#">End of Life Information</a>
WEEE	The product must be disposed on European Union markets following specific waste collection and never end up in rubbish bins
California proposition 65	WARNING: This product can expose you to chemicals including: Lead and lead compounds, which is known to the State of California to cause cancer and birth defects or other reproductive harm. For more information go to <a href="http://www.P65Warnings.ca.gov">www.P65Warnings.ca.gov</a>

## Contractual warranty

Warranty	18 months
----------	-----------

## Frame Size C

### Dimensions

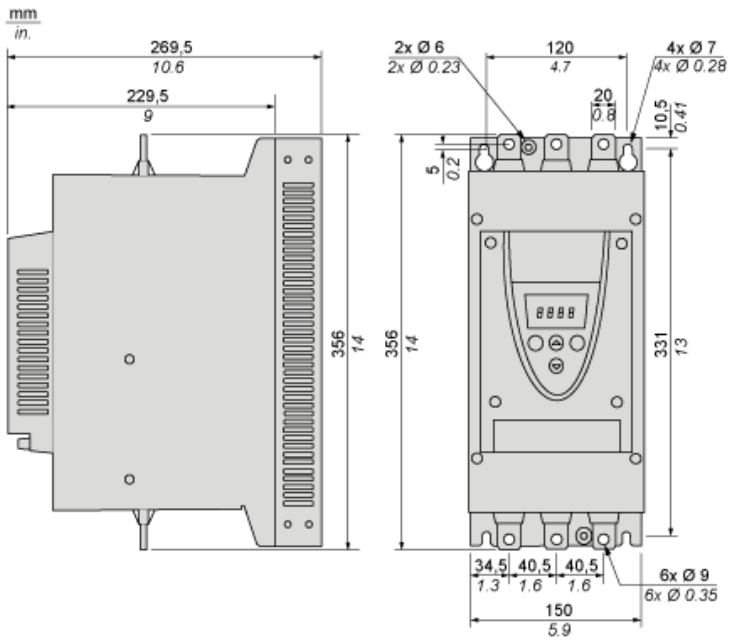

**Precautions**

**Standards**

The Altistart 22 soft starter is compliant with pollution Degree 2 as defined in NEMA ICS1-1 or IEC 60664-1.  
For environment pollution degree 3, install the Altistart 22 soft starter inside a cabinet type 12 or IP54.

**⚠ DANGER**

HAZARD OF ELECTRIC SHOCK, EXPLOSION, OR ARC FLASH  
ATS22 soft starters are open devices and must be mounted in a suitable enclosure.  
Failure to follow these instructions will result in death or serious injury.

**Air Circulation**

Leave sufficient free space to help the air required for cooling purposes to circulate from the bottom to the top of the unit.

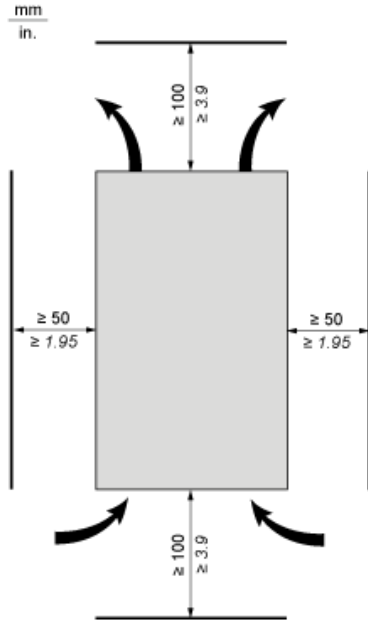

**Overheating**

To avoid the soft starter to overheat, respect the following recommendations:

- Mount the Altistart 22 Soft Starter within  $\pm 10^\circ$  of vertical.
- Do not locate the Altistart 22 Soft Starter near heat radiating elements.
- Electrical current through the Altistart 22 Soft Starter will result in heat losses that must be dissipated into the ambient air immediately surrounding the unit.
- If several soft starters are installed in a control panel, arrange them in a row. Do not stack soft starters. Heat generated from the bottom soft starter can affect the top soft starter.

**Mounting**

---

**Connection Between the Fan and the Altistart 22 Soft Starter**

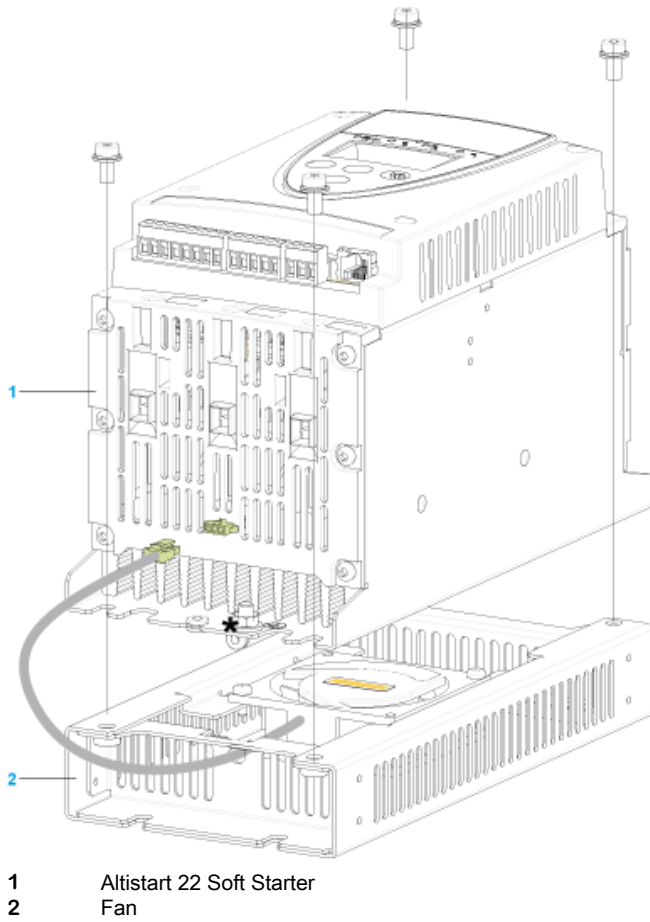

**Wall mounted or Floor-standing Enclosure with IP 23 Degree of protection**

---

**Introduction**

To help proper air circulation in the soft starter, grilles and forced ventilation can be installed.

**Ventilation Grilles**

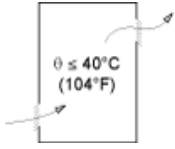

**Forced Ventilation Unit**

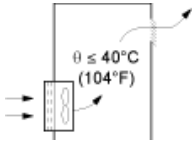

**Power Terminal**

**Bar Style**

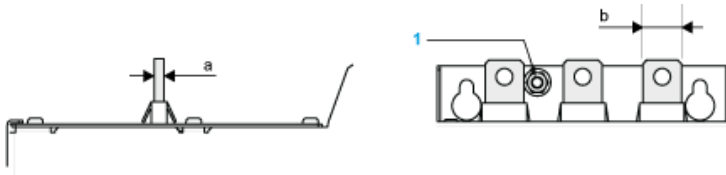

Power supply and output to motor	Bar	b	20 mm (0.79 in)
		a	5 mm (0.2 in)
		Bolt	M8 (0.31 in)
	Cable and protective cover	Size	95 mm <sup>2</sup>
		Gauge	250 MCM
		Protective cover	LA9F702
		Tightening torque	18 N.m
			157.5 lb.in

**Power connections, minimum required wiring section**

IEC cable mm <sup>2</sup> (Cu 70°C/158°F) (1)	UL cable AWG (Cu 75°C/167°F) (1)
50	2/0



**110 Vac control, Logic Inputs (LI) 110 Vac, 3-wire control**

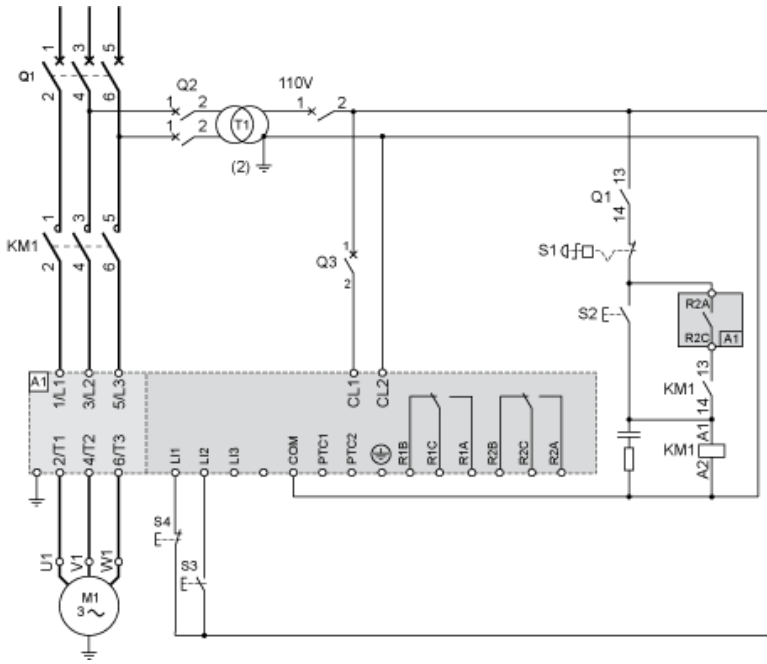

110 Vac control, Logic Inputs (LI) 110 Vac, 2-wire control, freewheelstop

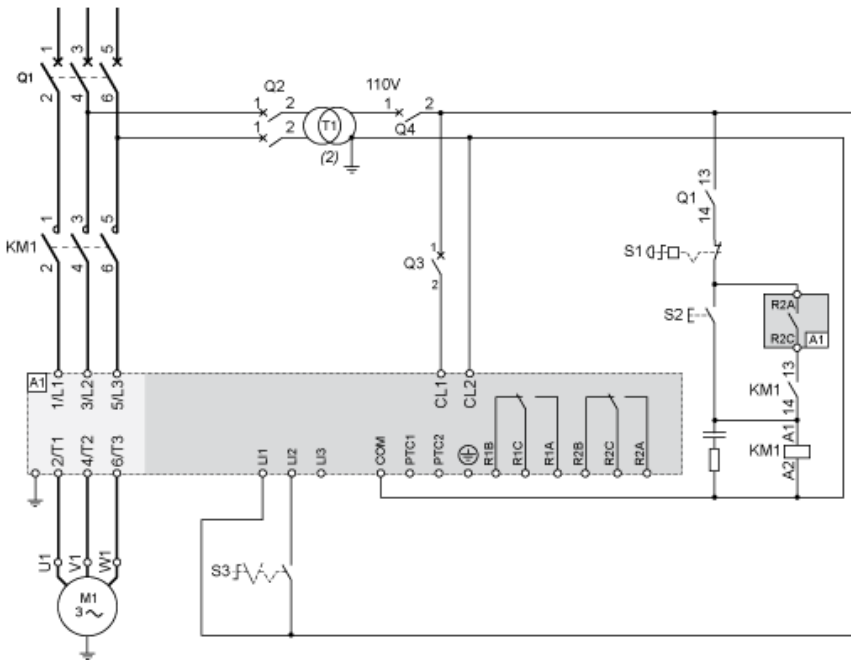

**Motor Thermal Protection - Cold Curves**

**Curves**

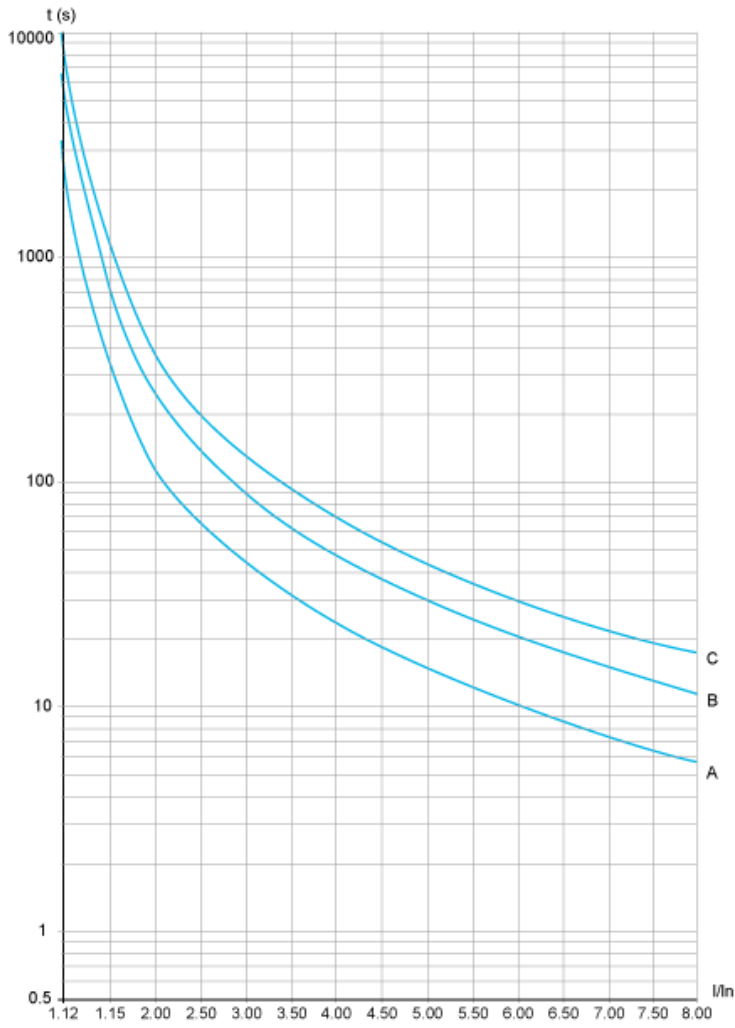

- A** Class 10
- B** Class 20
- C** Class 30

**Trip time for a Standard Application (Class 10)**

3.5 In
32 s

**Trip time for a Severe Application (Class 20)**

3.5 In
63 s

**Trip time for a Severe Application (Class 30)**

3.5 In
95 s

**Motor Thermal Protection - Warm Curves**

**Curves**

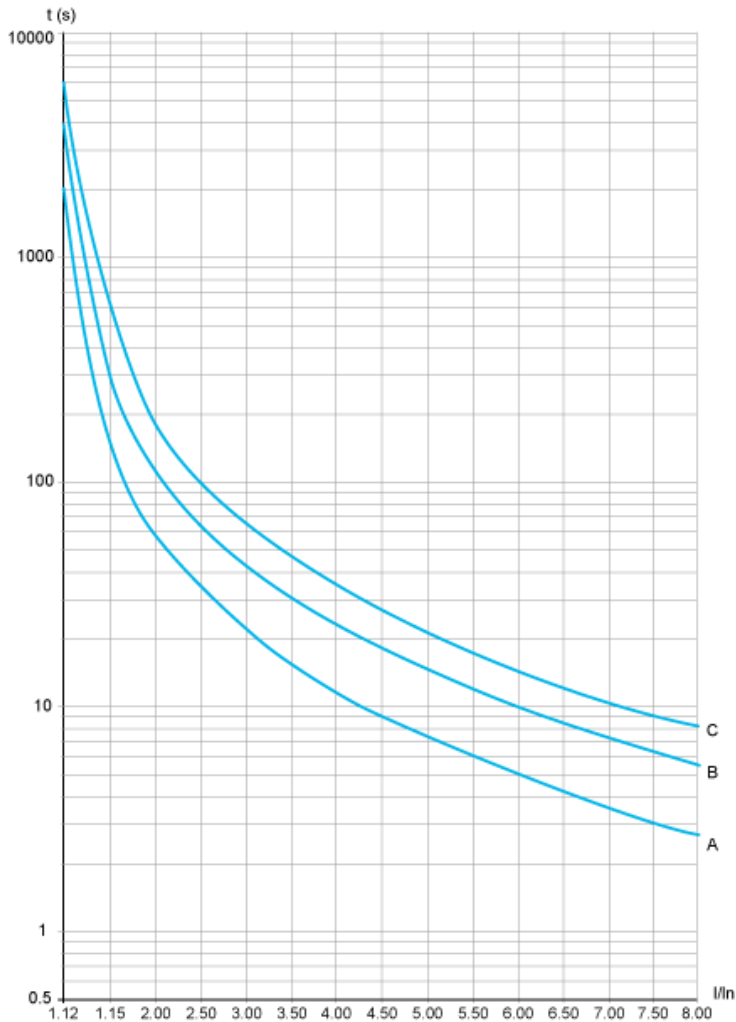

- A** Class 10
- B** Class 20
- C** Class 30

**Trip time for a Standard Application (Class 10)**

3.5 In
16 s

**Trip time for a Severe Application (Class 20)**

3.5 In
32 s

**Trip time for a Severe Application (Class 30)**

3.5 In
48 s

**Recommended replacement(s)**