

## Metallized Polyester Film Capacitors MKT Radial Potted Type

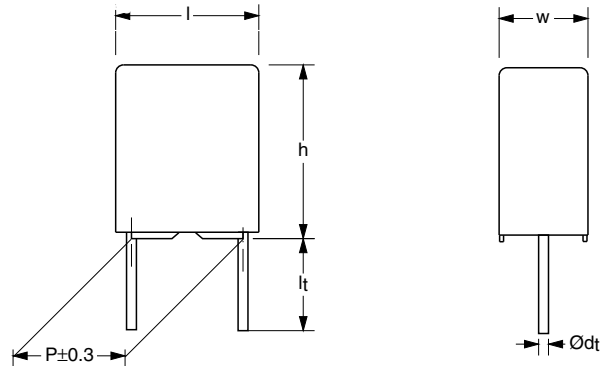

Dimensions in mm

### APPLICATIONS

Blocking, coupling and decoupling. Bypass and energy reservoir

### MARKING

C-value; tolerance; rated voltage; year and week of manufacturer; manufacturer's type designation, manufacturers logo or name, location

### DIELECTRIC

Polyester film

### ELECTRODES

Vacuum deposited aluminum

### ENCAPSULATION

Flame retardant plastic case and epoxy resin (UL-class 94 V-0)

### CONSTRUCTION

Wound mono construction

### LEADS

Tinned wire

### CAPACITANCE TOLERANCE

± 10 %; ± 5 %

### FEATURES

Pitch 5 mm available loose in box, ammopack and taped on reel.

- Material categorization:  
For definitions of compliance please see [www.vishay.com/doc?99912](http://www.vishay.com/doc?99912)

### CAPACITANCE RANGE (E12 SERIES)

0.001  $\mu$ F to 1.2  $\mu$ F

### RATED (DC) VOLTAGE

63 V; 100 V; 250 V; 400 V

### RATED (AC) VOLTAGE

40 V; 63 V; 160 V; 200 V

### CLIMATIC CATEGORY

55/125/56

### RATED TEMPERATURE

85 °C

### MAXIMUM APPLICATION TEMPERATURE

125 °C

### REFERENCE SPECIFICATIONS

IEC 60384-2

### PERFORMANCE GRADE

Grade 1 (long life)

### DETAIL SPECIFICATION

For more detailed data and test requirements contact: [dc-film@vishay.com](mailto:dc-film@vishay.com)



## COMPOSITION OF CATALOG NUMBER

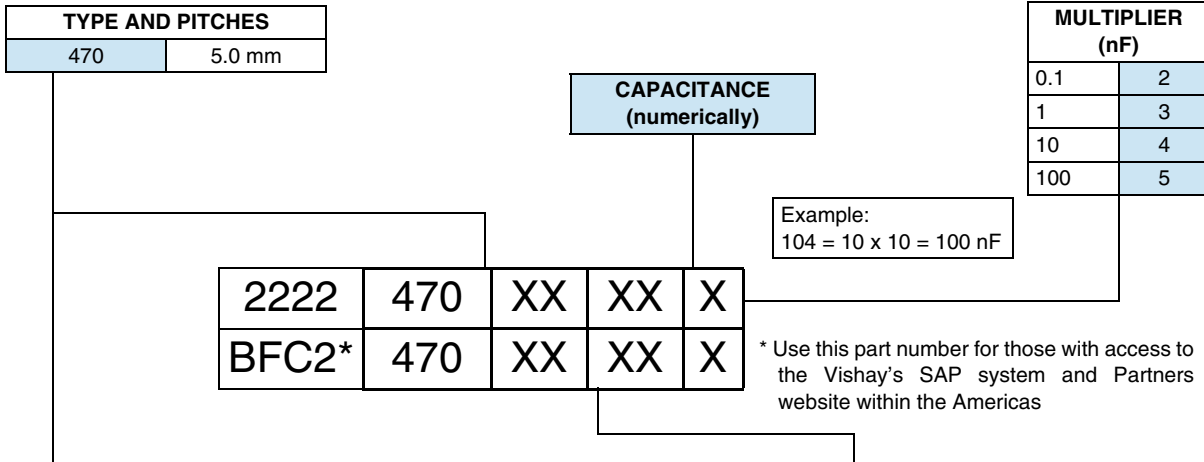

TYPE	PACKAGING	LEAD CONFIGURATION	PREFERRED TYPES				
			C-TOL.	63 V	100 V	250 V	400 V
470	ammopack	H = 18.5 mm; P <sub>0</sub> = 12.7 mm	± 10 %	75	85	35	65
			± 5 %	76	86	36	66
			ON REQUEST				
470	loose in box	lead length 4.0 + 1.0/- 0.5 mm	± 10 %	11	21	41	51
			± 5 %	12	22	42	52
		lead length 26.0 ± 2.0 mm	± 10 %	15	25	45	55
			± 5 %	16	26	46	56
	taped on reel	H = 18.5 mm; P <sub>0</sub> = 12.7 mm; reel diameter 356 mm	± 10 %	18	28	48	58
			± 5 %	19	29	49	59

### Note

- For detailed tape specification refer to packaging information [www.vishay.com/doc?27139](http://www.vishay.com/doc?27139)

## SPECIFIC REFERENCE DATA

DESCRIPTION	VALUE			
	at 1 kHz	at 10 kHz	at 100 kHz	at 1 MHz
Tangent of loss angle:				
C ≤ 0.1 μF	≤ 60 x 10 <sup>-4</sup>	≤ 120 x 10 <sup>-4</sup>	≤ 200 x 10 <sup>-4</sup>	≤ 250 x 10 <sup>-4</sup> (1)
0.1 μF < C ≤ 0.47 μF	≤ 60 x 10 <sup>-4</sup>	≤ 120 x 10 <sup>-4</sup>	≤ 200 x 10 <sup>-4</sup>	-
0.47 μF < C ≤ 1.2 μF	≤ 60 x 10 <sup>-4</sup>	≤ 120 x 10 <sup>-4</sup>	-	-
Rated voltage pulse slope (dU/dt) <sub>R</sub> at	63 V <sub>DC</sub>	100 V <sub>DC</sub>	250 V <sub>DC</sub>	400 V <sub>DC</sub>
	100 V/μs	160 V/μs	400 V/μs	800 V/μs
R between leads, for C ≤ 0.33 μF:				
at 10 V; 1 min	> 15 000 MΩ			
at 100 V; 1 min		> 15 000 MΩ	> 15 000 MΩ	> 15 000 MΩ
RC between leads, for C > 0.33 μF				
at 10 V; 1 min	> 5000 s			
at 100 V; 1 min		> 5000 s		
R between interconnected leads and casing (foil method)	> 30 000 MΩ	> 30 000 MΩ	> 30 000 MΩ	> 30 000 MΩ
Withstanding (DC) voltage (cut off current 10 mA) (2); rise time ≤ 1000 V/s	100 V; 1 min	160 V; 1 min	400 V; 1 min	640 V; 1 min
Withstanding (DC) voltage between leads and case	200 V; 1 min	200 V; 1 min	500 V; 1 min	800 V; 1 min

### Notes

- (1) Only for 250 V and 400 V for C ≤ 0.01 μF  
 (2) See "Voltage Proof Test for Metalized Film Capacitors": [www.vishay.com/doc?28169](http://www.vishay.com/doc?28169)



Metallized Polyester Film Capacitors    Vishay BCcomponents  
MKT Radial Potted Type

$U_{Rdc} = 63 \text{ V}$ ;  $U_{Rac} = 40 \text{ V}$

C ( $\mu\text{F}$ )	DIMENSIONS W x H x L (mm)	MASS <sup>(1)</sup> (g)	CATALOG NUMBER 2222 470 ... AND PACKAGING						
			AMMOPACK <sup>(2)</sup>			REEL <sup>(2)</sup>	LOOSE IN BOX		
			H = 18.5 mm			SPQ	SPQ	short leads	long leads
			C-tol. = $\pm 10\%$ last 5 digits of catalog number	C-tol. = $\pm 5\%$ last 5 digits of catalog number	SPQ			SPQ	SPQ
<b>Pitch = <math>5.0 \pm 0.3 \text{ mm}</math>; <math>d_t = 0.50 \pm 0.05 \text{ mm}</math></b>									
0.068	2.5 x 6.5 x 7.2	0.25	75683	76683	2000	2000	2000	1000	
0.082			75823	76823					
0.1			75104	76104					
0.12	3.5 x 8.0 x 7.2	0.35	75124	76124	1500	1500	2000	1000	
0.15			75154	76154					
0.18			75184	76184					
0.22			75224	76224					
0.27			75274	76274					
0.33			75334	76334					
0.39	75394	76394							
0.47	4.5 x 9.0 x 7.2	0.45	75474	76474	1000	1000	2000	1000	
0.56			75564	76564					
0.68			75684	76684					
0.82	6.0 x 11.0 x 7.2	0.60	75824	76824	750	1000	2000	1000	
1			75105	76105					
1.2			75125	76125					

**Notes**

- (1) Net weight for short lead product only
- (2) H = In-tape height;  $P_0$  = Sprocket hole distance; for detailed specifications refer to Packaging Information
- SPQ = Standard packing quantity

$U_{Rdc} = 100 \text{ V}$ ;  $U_{Rac} = 63 \text{ V}$

C ( $\mu\text{F}$ )	DIMENSIONS W x H x L (mm)	MASS <sup>(1)</sup> (g)	CATALOG NUMBER 2222 470 ... AND PACKAGING						
			AMMOPACK <sup>(2)</sup>			REEL <sup>(2)</sup>	LOOSE IN BOX		
			H = 18.5 mm			SPQ	SPQ	short leads	long leads
			C-tol. = $\pm 10\%$ last 5 digits of catalog number	C-tol. = $\pm 5\%$ last 5 digits of catalog number	SPQ			SPQ	SPQ
<b>Pitch = <math>5.0 \pm 0.3 \text{ mm}</math>; <math>d_t = 0.50 \pm 0.05 \text{ mm}</math></b>									
0.022	2.5 x 6.5 x 7.2	0.25	85223	86223	2000	2000	2000	1000	
0.027			85273	86273					
0.033			85333	86333					
0.039			85393	86393					
0.047			85473	86473					
0.056			85563	86563					
0.068	3.5 x 8.0 x 7.2	0.35	85683	86683	1500	1500	2000	1000	
0.082			85823	86823					
0.1			85104	86104					
0.12			85124	86124					
0.15	4.5 x 9.0 x 7.2	0.45	85154	86154	1000	1000	2000	1000	
0.18			85184	86184					
0.22			85224	86224					
0.27			85274	86274					
0.33	6.0 x 11.0 x 7.2	0.65	85334	86334	750	1000	2000	1000	
0.39			85394	86394					
0.47			85474	86474					

**Notes**

- (1) Net weight for short lead product only
- (2) H = In-tape height;  $P_0$  = Sprocket hole distance; for detailed specifications refer to Packaging Information
- SPQ = Standard packing quantity

Vishay BCcomponents Metallized Polyester Film Capacitors  
MKT Radial Potted Type

$U_{Rdc} = 250\text{ V}$ ;  $U_{Rac} = 160\text{ V}$

C ( $\mu\text{F}$ )	DIMENSIONS W x H x L (mm)	MASS <sup>(1)</sup> (g)	CATALOG NUMBER 2222 470 ... AND PACKAGING						
			AMMOPACK <sup>(2)</sup>			REEL <sup>(2)</sup>	LOOSE IN BOX		
			H = 18.5 mm			SPQ	SPQ	short leads	long leads
			C-tol. = $\pm 10\%$	C-tol. = $\pm 5\%$	SPQ			SPQ	
			last 5 digits of catalog number	last 5 digits of catalog number					
<b>Pitch = <math>5.0 \pm 0.3\text{ mm}</math>; <math>d_t = 0.50 \pm 0.05\text{ mm}</math></b>									
0.01	2.5 x 6.5 x 7.2	0.25	35103	36103	2000	2000	2000	1000	
0.012			35123	36123					
0.015			35153	36153					
0.018			35183	36183					
0.022	3.5 x 8.0 x 7.2	0.35	35223	36223	1500	1500	2000	1000	
0.027			35273	36273					
0.033			35333	36333					
0.039			35393	36393					
0.047	4.5 x 9.0 x 7.2	0.45	35473	36473	1000	1000	2000	1000	
0.056			35563	36563					
0.068			35683	36683					
0.082	6.0 x 11.0 x 7.2	0.60	35823	36823	750	1000	2000	1000	
0.1			35104	36104					
0.12			35124	36124					

Notes

<sup>(1)</sup> Net weight for short lead product only

<sup>(2)</sup> H = In-tape height;  $P_0$  = Sprocket hole distance; for detailed specifications refer to Packaging Information

- SPQ = Standard packing quantity

$U_{Rdc} = 400\text{ V}$ ;  $U_{Rac} = 200\text{ V}$

C ( $\mu\text{F}$ )	DIMENSIONS W x H x L (mm)	MASS <sup>(1)</sup> (g)	CATALOG NUMBER 2222 470 ... AND PACKAGING						
			AMMOPACK <sup>(2)</sup>			REEL <sup>(2)</sup>	LOOSE IN BOX		
			H = 18.5 mm			SPQ	SPQ	short leads	long leads
			C-tol. = $\pm 10\%$	C-tol. = $\pm 5\%$	SPQ			SPQ	
			last 5 digits of catalog number	last 5 digits of catalog number					
<b>Pitch = <math>5.0 \pm 0.3\text{ mm}</math>; <math>d_t = 0.50 \pm 0.05\text{ mm}</math></b>									
0.001	2.5 x 6.5 x 7.2	0.25	65102	66102	2000	2000	2000	1000	
0.0012			65122	66122					
0.0015			65152	66152					
0.0018			65182	66182					
0.0022			65222	66222					
0.0027			65272	66272					
0.0033			65332	66332					
0.0039			65392	66392					
0.0047			65472	66472					
0.0056			65562	66562					
0.0068			65682	66682					
0.0082			65822	66822					
0.01	3.5 x 8.0 x 7.2	0.35	65103	66103	1500	1500	2000	1000	
0.012			65123	66123					
0.015			65153	66153					
0.018	4.5 x 9.0 x 7.2	0.45	65183	66183	1000	1000	2000	1000	
0.022			65223	66223					
0.027			65273	66273					
0.033	6.0 x 11.0 x 7.2	0.60	65333	66333	750	1000	2000	1000	
0.039			65393	66393					
0.047			65473	66473					

Notes

<sup>(1)</sup> Net weight for short lead product only

<sup>(2)</sup> H = In-tape height;  $P_0$  = Sprocket hole distance; for detailed specifications refer to Packaging Information

- SPQ = Standard packing quantity

## MOUNTING

### Normal Use

The capacitors are designed for mounting on printed-circuit boards. The capacitors packed in bandoliers are designed for mounting in printed-circuit boards by means of automatic insertion machines.

For detailed tape specifications refer to: "Packaging Information": [www.vishay.com/doc?28139](http://www.vishay.com/doc?28139)

### Specific Method of Mounting to Withstand Vibration and Shock

In order to withstand vibration and shock tests, it must be ensured that the stand-off pips are in good contact with the printed-circuit board:

- For pitches  $\leq 15$  mm capacitors shall be mechanically fixed by the leads
- For larger pitches the capacitors shall be mounted in the same way and the body clamped

### Space Requirements on Printed-Circuit Board

The maximum space for length ( $l_{max.}$ ), width ( $w_{max.}$ ) and height ( $h_{max.}$ ) of film capacitors to take in account on the printed circuit board is shown in the drawings.

For products with pitch  $\leq 15$  mm,  $\Delta w = \Delta l = 0.3$  mm and  $\Delta h = 0.1$  mm

Eccentricity defined as in drawing. The maximum eccentricity is smaller than or equal to the lead diameter of the product concerned.

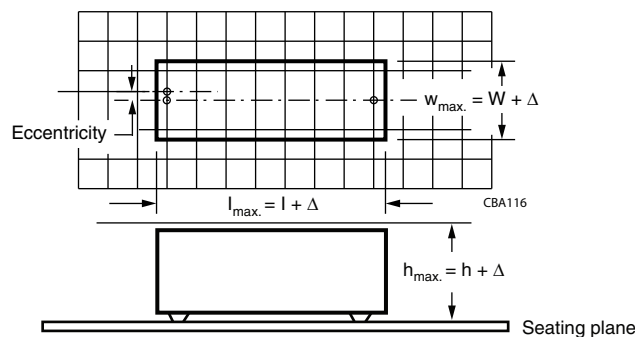

## SOLDERING

For general soldering conditions and wave soldering profile, we refer to the application note:

"Soldering Guidelines for Film Capacitors": [www.vishay.com/doc?28171](http://www.vishay.com/doc?28171)

### Storage Temperature

Storage temperature:  $T_{stg} = -25$  °C to  $+40$  °C with RH maximum 80 % without condensation

### Ratings and Characteristics Reference Conditions

Unless otherwise specified, all electrical values apply to an ambient temperature of  $23$  °C  $\pm 1$  °C, an atmospheric pressure of 86 kPa to 106 kPa and a relative humidity of  $50$  %  $\pm 2$  %.

For reference testing, a conditioning period shall be applied over  $96$  h  $\pm 4$  h by heating the products in a circulating air oven at the rated temperature and a relative humidity not exceeding 20 %.

**CHARACTERISTICS**

Capacitance as a function of frequency (typical curve)

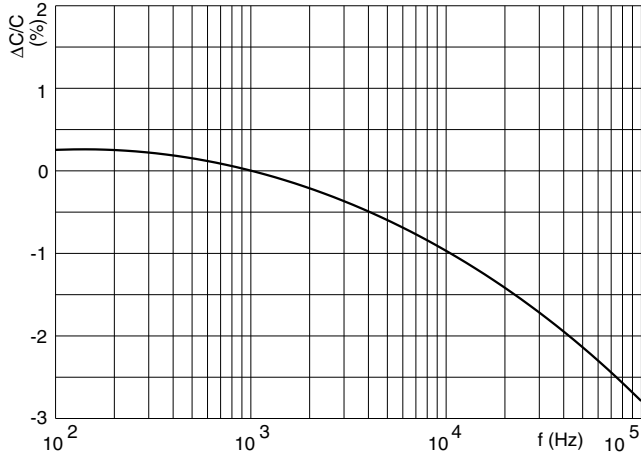

Capacitance as a function of ambient temperature (typical curve)

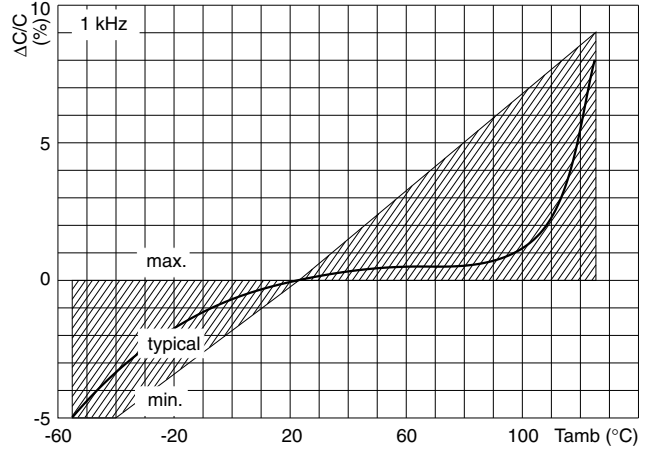

Impedance as a function of frequency (typical curve)

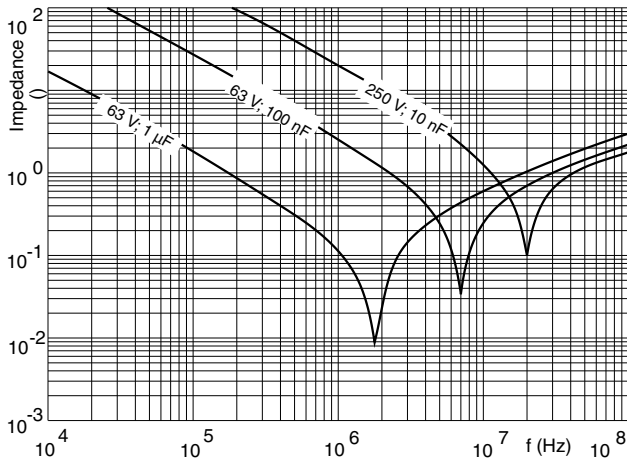

Maximum DC and AC voltage as a function of temperature

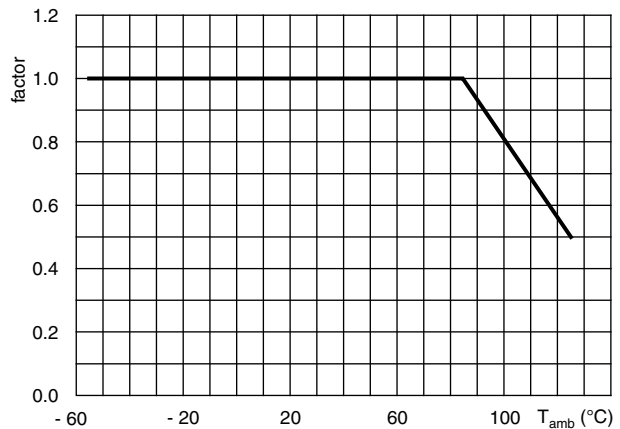

Maximum RMS voltage as a function of frequency

Maximum RMS current as a function of frequency



Metallized Polyester Film Capacitors Vishay BCcomponents  
MKT Radial Potted Type

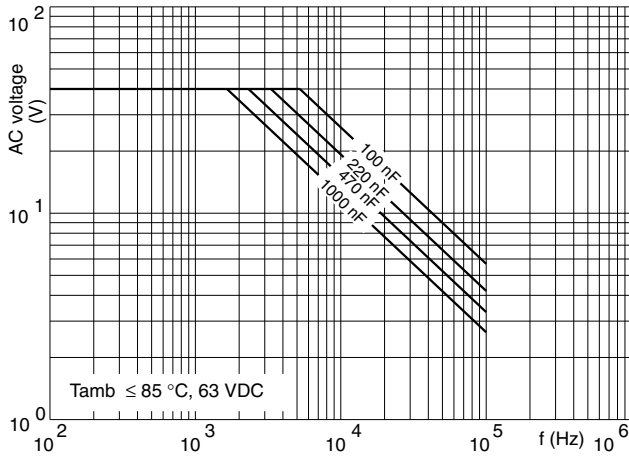

Maximum RMS voltage as a function of frequency

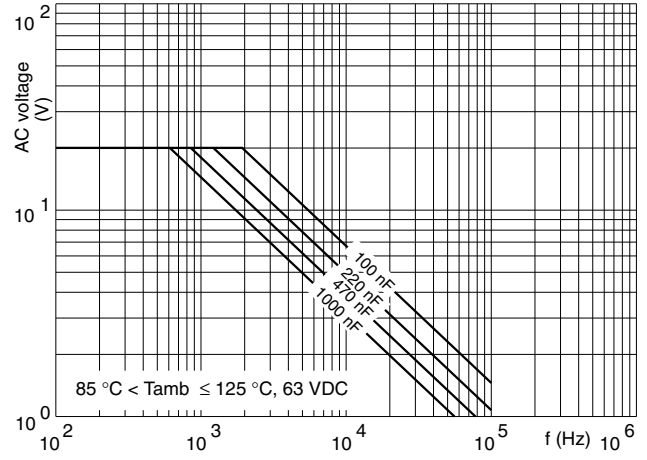

Maximum RMS current as a function of frequency

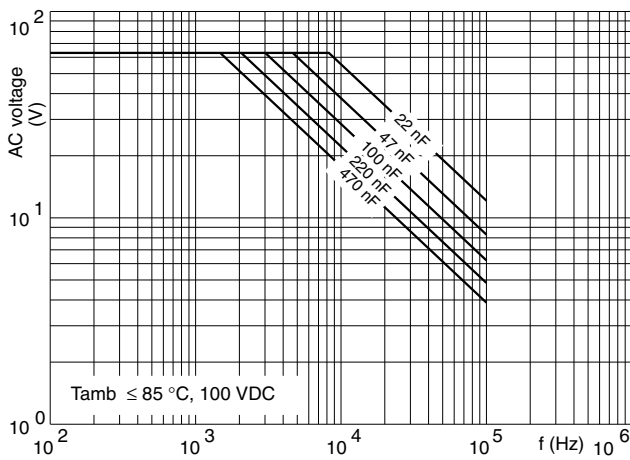

Maximum RMS voltage as a function of frequency

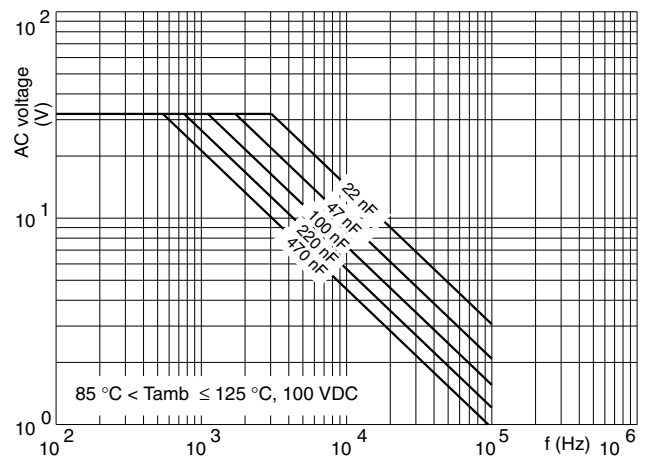

Maximum RMS current as a function of frequency

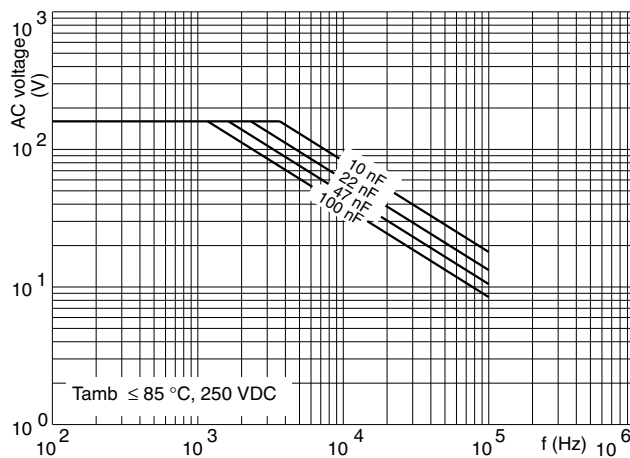

Maximum RMS voltage as a function of frequency

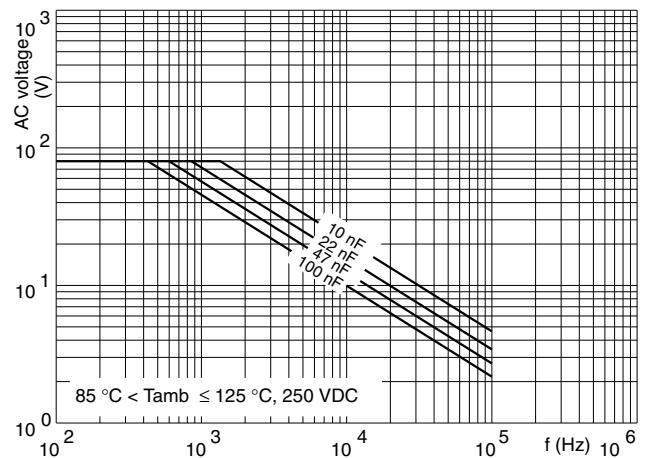

Maximum RMS current as a function of frequency



Maximum RMS voltage as a function of frequency

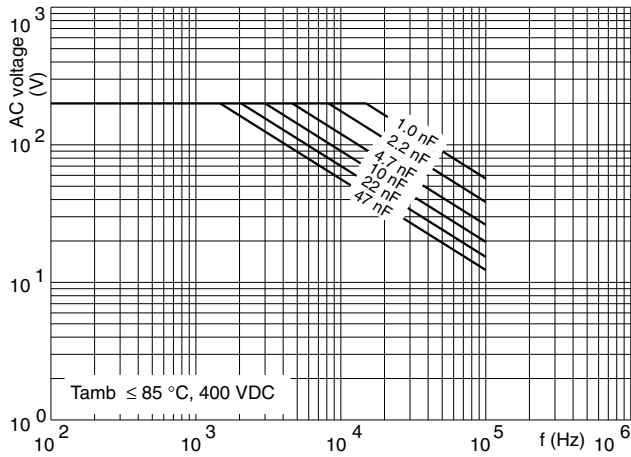

Maximum RMS current as a function of frequency

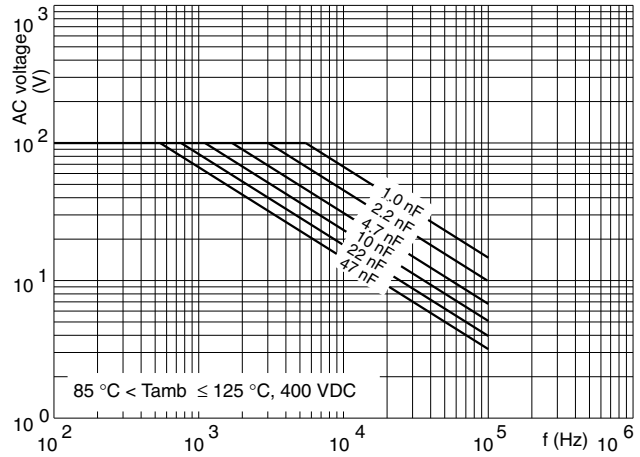

**MAXIMUM RMS CURRENT (SINEWAVE) AS A FUNCTION OF FREQUENCY**

The maximum RMS current is defined by  $I_{ac} = \omega \times C \times U_{ac}$ .

$U_{ac}$  is the maximum AC voltage depending on the ambient temperature in the curves “ Maximum RMS voltage and AC current as a function of frequency”.





Metallized Polyester Film Capacitors Vishay BCcomponents  
MKT Radial Potted Type

Tangent of loss angle as a function of frequency (typical curve)

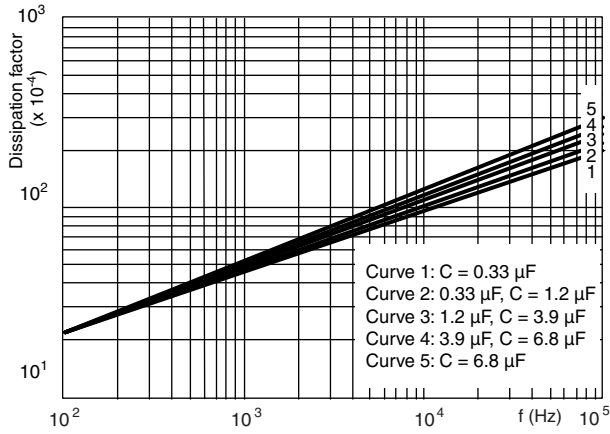

Insulation resistance as a function of ambient temperature (typical curve)

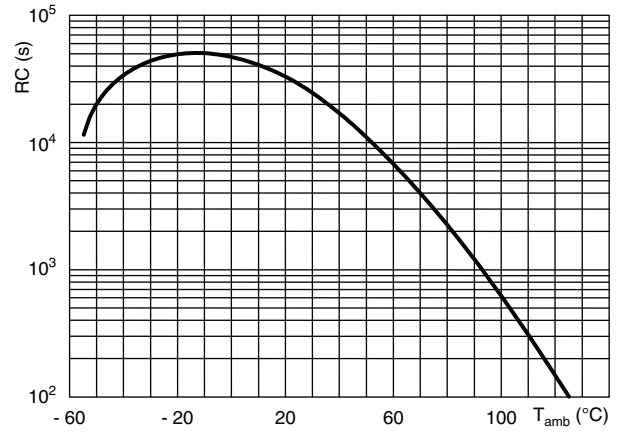

Maximum allowed component temperature rise (ΔT) as a function of the ambient temperature (T<sub>amb</sub>)

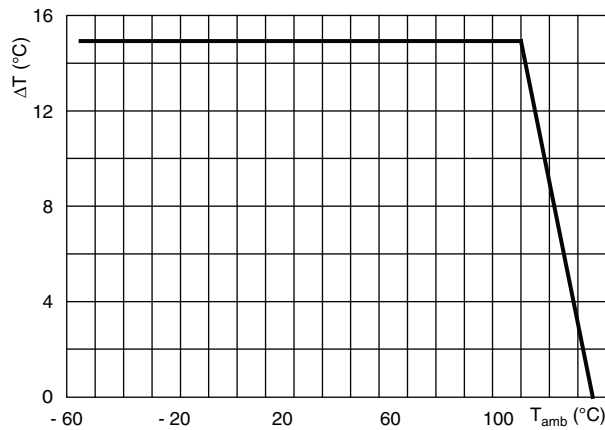

Maximum DC and AC voltage as a function of temperature

**HEAT CONDUCTIVITY (G) AS A FUNCTION OF PITCH AND CAPACITOR BODY THICKNESS IN mW/°C**

W <sub>max.</sub> (mm)	HEAT CONDUCTIVITY (mW/°C)
	PITCH 5 mm
2.5	2.5
3.5	3.0
4.5	4.0
6.0	5.5

**POWER DISSIPATION AND MAXIMUM COMPONENT TEMPERATURE RISE**

The power dissipation must be limited in order not to exceed the maximum allowed component temperature rise as a function of the free ambient temperature.

The power dissipation can be calculated according type detail specification "HQN-384-01/101: Technical Information Film Capacitors".

The component temperature rise ( $\Delta T$ ) can be measured (see section "Measuring the Component Temperature" for more details) or calculated by  $\Delta T = P/G$ :

- $\Delta T$  = Component temperature rise (°C)
- P = Power dissipation of the component (mW)
- G = Heat conductivity of the component (mW/°C)

**MEASURING THE COMPONENT TEMPERATURE**

A thermocouple must be attached to the capacitor body as in:

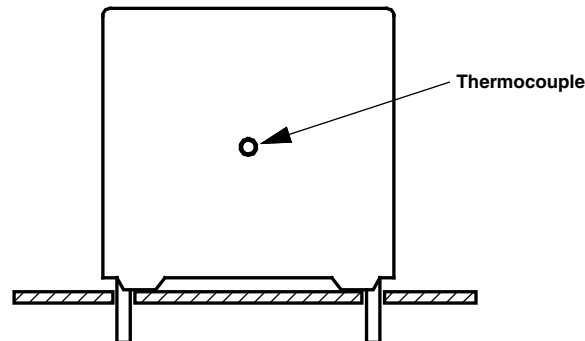

The temperature is measured in unloaded ( $T_{amb}$ ) and maximum loaded condition ( $T_C$ ).

The temperature rise is given by  $\Delta T = T_C - T_{amb}$ .

To avoid radiation or convection, the capacitor should be tested in a wind-free box.



Metallized Polyester Film Capacitors Vishay BCcomponents  
MKT Radial Potted Type

**APPLICATION NOTE AND LIMITING CONDITIONS**

These capacitors are not suitable for mains applications as across-the-line capacitors without additional protection, as described hereunder. These mains applications are strictly regulated in safety standards and therefore electromagnetic interference suppression capacitors conforming the standards must be used.

For capacitors connected in parallel, normally the proof voltage and possibly the rated voltage must be reduced. For information depending of the capacitance value and the number of parallel connections contact: [dc-film@vishay.com](mailto:dc-film@vishay.com)

To select the capacitor for a certain application, the following conditions must be checked:

1. The peak voltage ( $U_P$ ) shall not be greater than the rated DC voltage ( $U_{RDC}$ ).
2. The peak-to-peak voltage ( $U_{P-P}$ ) shall not be greater than  $2\sqrt{2} \times U_{RAC}$  to avoid the ionization inception level.
3. The voltage pulse slope ( $dU/dt$ ) shall not exceed the rated voltage pulse slope in an RC-circuit at rated voltage and without ringing. If the pulse voltage is lower than the rated DC voltage, the rated voltage pulse slope may be multiplied by  $U_{RDC}$  and divided by the applied voltage.

For all other pulses following equation must be fulfilled:

$$2 \times \int_0^T \left(\frac{dU}{dt}\right)^2 \times dt < U_{Rdc} \times \left(\frac{dU}{dt}\right)_{rated}$$

T is the pulse duration.

The rated voltage pulse slope is valid for ambient temperatures up to 85 °C. For higher temperatures a derating factor of 3 % per K shall be applied.

4. The maximum component surface temperature rise must be lower than the limits (see graph “Max. allowed component temperature rise”).
5. Since in circuits used at voltages over 280 V peak-to-peak the risk for an intrinsically active flammability after a capacitor breakdown (short circuit) increases, it is recommended that the power to the component is limited to 100 times the values mentioned in the table: “Heat Conductivity”
6. When using these capacitors as across-the-line capacitor in the input filter for mains applications the applicant must guarantee that the following conditions are fulfilled in any case (spikes and surge voltages from the mains or line card supply included).
7. For continuous use as series connection with an impedance to the mains, please refer to application note [www.vishay.com/doc?28153](http://www.vishay.com/doc?28153).

**Voltage Conditions for 6 Above**

ALLOWED VOLTAGES	$T_{amb} \leq 85 \text{ °C}$	$85 \text{ °C} < T_{amb} \leq 100 \text{ °C}$	$100 \text{ °C} < T_{amb} \leq 125 \text{ °C}$
Maximum continuous RMS voltage	$U_{RAC}$	$0.8 \times U_{RAC}$	$0.5 \times U_{RAC}$
Maximum temperature RMS-overvoltage (< 24 h)	$1.25 \times U_{RAC}$	$U_{RAC}$	$0.625 \times U_{RAC}$
Maximum peak voltage ( $V_{O-P}$ ) (< 2 s)	$1.6 \times U_{RDC}$	$1.3 \times U_{RDC}$	$0.8 \times U_{RDC}$

## INSPECTION REQUIREMENTS

## General Notes:

Sub-clause numbers of tests and performance requirements refer to the “Sectional Specification, Publication IEC 60384-2 and Specific Reference Data”.

## Group C Inspection Requirements

SUB-CLAUSE NUMBER AND TEST	CONDITIONS	PERFORMANCE REQUIREMENTS
<b>SUB-GROUP C1A PART OF SAMPLE OF SUB-GROUP C1</b>		
4.1 Dimensions (detail)		As specified in chapters “General Data” of this specification
4.3.1 Initial measurements	Capacitance Tangent of loss angle for: C ≤ 10 nF at 1 MHz 10 nF < C ≤ 470 nF at 100 kHz C > 470 nF at 10 kHz	No visible damage
4.3 Robustness of terminations	Tensile: Load 10 N; 10 s Bending: Load 5 N; 4 x 90°	
4.4 Resistance to soldering heat	Method: 1A Solder bath: 280 °C ± 5 °C Duration: 10 s	
4.14 Component solvent resistance	Isopropylalcohol at room temperature Method: 2 Immersion time: 5 min ± 0.5 min Recovery time: Min. 1 h, max. 2 h	
4.4.2 Final measurements	Visual examination  Capacitance Tangent of loss angle	No visible damage Legible marking  $ \Delta C/C  \leq 2\%$ of the value measured initially Increase of $\tan \delta$ ≤ 0.005 for: C ≤ 10 nF or ≤ 0.003 for: 10 nF < C ≤ 470 nF or ≤ 0.002 for: C > 470 nF Compared to values measured in 4.3.1
<b>SUB-GROUP C1B PART OF SAMPLE OF SUB-GROUP C1</b>		
4.6.1 Initial measurements	Capacitance Tangent of loss angle for: C ≤ 10 nF at 1 MHz 10 nF < C ≤ 470 nF at 100 kHz C > 470 nF at 10 kHz	
4.6 Rapid change of temperature	θA = - 55 °C θB = + 125 °C 5 cycles Duration t = 30 min	
4.7 Vibration	Visual examination Mounting: See section “Mounting” of this specification Procedure B4 Frequency range: 10 Hz to 55 Hz Amplitude: 0.75 mm or Acceleration 98 m/s <sup>2</sup> (whichever is less severe) Total duration 6 h	No visible damage
4.7.2 Final inspection	Visual examination	No visible damage



Metallized Polyester Film Capacitors Vishay BCcomponents  
MKT Radial Potted Type

SUB-CLAUSE NUMBER AND TEST	CONDITIONS	PERFORMANCE REQUIREMENTS
<b>SUB-GROUP C1B PART OF SAMPLE OF SUB-GROUP C1</b>		
4.9 Shock  4.9.3 Final measurements	Mounting: See section "Mounting" of this specification Pulse shape: Half sine Acceleration: 490 m/s <sup>2</sup> Duration of pulse: 11 ms  Visual examination Capacitance  Tangent of loss angle  Insulation resistance	No visible damage $ \Delta C/C  \leq 5\%$ for $w = 2.5$ mm or $ \Delta C/C  \leq 3\%$ for $w > 2.5$ mm of the value measured in 4.6.1 Increase of $\tan \delta$ : $\leq 0.005$ for: $C \leq 10$ nF or $\leq 0.003$ for: $10$ nF $< C \leq 470$ nF or $\leq 0.002$ for: $C > 470$ nF Compared to values measured in 4.6.1 As specified in section "Insulation Resistance" of this specification
<b>SUB-GROUP C1 COMBINED SAMPLE OF SPECIMENS OF SUB-GROUPS C1A AND C1B</b>		
4.10 Climatic sequence 4.10.2 Dry heat  4.10.3 Damp heat cyclic Test Db, first cycle 4.10.4 Cold  4.10.6 Damp heat cyclic Test Db, remaining cycles 4.10.6.2 Final measurements	Temperature: + 125 °C Duration: 16 h  Temperature: - 55 °C Duration: 2 h  Voltage proof = $U_{RDC}$ for 1 min within 15 min after removal from test chamber Visual examination  Capacitance  Tangent of loss angle  Insulation resistance	No breakdown or flash-over  No visible damage Legible marking $ \Delta C/C  \leq 5\%$ of the value measured in 4.4.2 or 4.9.3 Increase of $\tan \delta$ : $\leq 0.008$ for: $C \leq 10$ nF or $\leq 0.005$ for: $10$ nF $< C \leq 470$ nF or $\leq 0.003$ for: $C > 470$ nF Compared to values measured in 4.3.1 or 4.6.1 $\geq 50\%$ of values specified in section "Insulation Resistance" of this specification
<b>SUB-GROUP C2</b>		
4.11 Damp heat steady state 4.11.1 Initial measurements  4.11.3 Final measurements	56 days, 40 °C, 90 % to 95 % RH Capacitance Tangent of loss angle at 1 kHz Voltage proof = $U_{RDC}$ for 1 min within 15 min after removal from test chamber Visual examination  Capacitance Tangent of loss angle  Insulation resistance	No breakdown or flash-over  No visible damage Legible marking $ \Delta C/C  \leq 5\%$ of the value measured in 4.11.1. Increase of $\tan \delta$ : $\leq 0.005$ for: $C \leq 470$ nF or $\leq 0.003$ for: $C > 470$ nF Compared to values measured in 4.11.1 $\geq 50\%$ of values specified in section "Insulation Resistance" of this specification

SUB-CLAUSE NUMBER AND TEST	CONDITIONS	PERFORMANCE REQUIREMENTS
<b>SUB-GROUP C3</b>		
4.12 Endurance	Duration: 2000 h 1.25 x U <sub>RDC</sub> at 85 °C 0.625 x U <sub>RDC</sub> at 125 °C	
4.12.1 Initial measurements	Capacitance Tangent of loss angle for: C ≤ 10 nF at 1 MHz 10 nF < C ≤ 470 nF at 100 kHz C > 470 nF at 10 kHz	No visible damage Legible marking  ΔC/C  ≤ 5 % compared to values measured in 4.12.1 Increase of tan δ: ≤ 0.005 for: C ≤ 10 nF or ≤ 0.003 for: 10 nF < C ≤ 470 nF or ≤ 0.002 for: C > 470 nF Compared to values measured in 4.12.1 ≥ 50 % of values specified in section "Insulation Resistance" of this specification
4.12.5 Final measurements	Visual examination  Capacitance  Tangent of loss angle  Insulation resistance	
<b>SUB-GROUP C4</b>		
4.13 Charge and discharge	10 000 cycles Charged to U <sub>RDC</sub> Discharge resistance: $R = \frac{U_R}{C \times 5 \times (dU/dt)_R}$	ΔC/C  ≤ 3 % compared to values measured in 4.13.1 Increase of tan δ: ≤ 0.005 for: C ≤ 10 nF or ≤ 0.003 for: 10 nF < C ≤ 470 nF or ≤ 0.002 for: C > 470 nF Compared to values measured in 4.13.1 ≥ 50 % of values specified in section "Insulation Resistance" of this specification
4.13.1 Initial measurements	Capacitance Tangent of loss angle for: C ≤ 10 nF at 1 MHz 10 nF < C ≤ 470 nF at 100 kHz C > 470 nF at 10 kHz	
4.13.3 Final measurements	Capacitance  Tangent of loss angle  Insulation resistance	



## Disclaimer

ALL PRODUCT, PRODUCT SPECIFICATIONS AND DATA ARE SUBJECT TO CHANGE WITHOUT NOTICE TO IMPROVE RELIABILITY, FUNCTION OR DESIGN OR OTHERWISE.

Vishay Intertechnology, Inc., its affiliates, agents, and employees, and all persons acting on its or their behalf (collectively, "Vishay"), disclaim any and all liability for any errors, inaccuracies or incompleteness contained in any datasheet or in any other disclosure relating to any product.

Vishay makes no warranty, representation or guarantee regarding the suitability of the products for any particular purpose or the continuing production of any product. To the maximum extent permitted by applicable law, Vishay disclaims (i) any and all liability arising out of the application or use of any product, (ii) any and all liability, including without limitation special, consequential or incidental damages, and (iii) any and all implied warranties, including warranties of fitness for particular purpose, non-infringement and merchantability.

Statements regarding the suitability of products for certain types of applications are based on Vishay's knowledge of typical requirements that are often placed on Vishay products in generic applications. Such statements are not binding statements about the suitability of products for a particular application. It is the customer's responsibility to validate that a particular product with the properties described in the product specification is suitable for use in a particular application. Parameters provided in datasheets and / or specifications may vary in different applications and performance may vary over time. All operating parameters, including typical parameters, must be validated for each customer application by the customer's technical experts. Product specifications do not expand or otherwise modify Vishay's terms and conditions of purchase, including but not limited to the warranty expressed therein.

Hyperlinks included in this datasheet may direct users to third-party websites. These links are provided as a convenience and for informational purposes only. Inclusion of these hyperlinks does not constitute an endorsement or an approval by Vishay of any of the products, services or opinions of the corporation, organization or individual associated with the third-party website. Vishay disclaims any and all liability and bears no responsibility for the accuracy, legality or content of the third-party website or for that of subsequent links.

Except as expressly indicated in writing, Vishay products are not designed for use in medical, life-saving, or life-sustaining applications or for any other application in which the failure of the Vishay product could result in personal injury or death. Customers using or selling Vishay products not expressly indicated for use in such applications do so at their own risk. Please contact authorized Vishay personnel to obtain written terms and conditions regarding products designed for such applications.

No license, express or implied, by estoppel or otherwise, to any intellectual property rights is granted by this document or by any conduct of Vishay. Product names and markings noted herein may be trademarks of their respective owners.