



MPQ7200

42V, 1.2A Buck-Boost or 3A Buck Synchronous LED Driver, AEC-Q100 Qualified

DESCRIPTION

The MPQ7200 is a high-frequency, constant-current, buck-boost LED driver with integrated power MOSFETs. It offers a very compact solution to achieve up to 1.2A of continuous output current, with excellent load and line regulation across a wide input supply range. The MPQ7200 can also be configured for buck mode to provide up to 3A of constant load current.

Constant frequency hysteretic control provides extremely fast transient response without loop compensation. The switching frequency can be fixed up to 2.3MHz in buck mode to reduce the current ripple and improve EMI. It can also be configured to as low as 1.15MHz for optimized efficiency and thermal performance in buck-boost mode.

Full protection features include over-current protection (OCP), output over-voltage protection (OVP) and under-voltage protection (UVP), thermal derating (TD), and thermal shutdown (TSD). The fault indicator outputs an active logic low signal if a fault condition occurs.

The MPQ7200 requires a minimal number of readily available, standard external components, and is available in a space-saving QFN-19 (3mmx4mm) package.

FEATURES

- Wide 6V to 42V Operating Input Voltage Range
- 44mΩ/40mΩ Low $R_{DS(ON)}$ Internal Power MOSFETs
- High-Efficiency Synchronous Operation
- Configurable 1.2A Buck-Boost Mode or 3A Buck Mode
- Configurable LED Current without Sensing Resistor
- Default 2.3MHz Switching Frequency for Buck Mode and 1.15MHz Switching Frequency for Buck-Boost Mode with Spread Spectrum
- PWM Dimming (Dimming Frequency from 100Hz to 2kHz)
- Internal 500Hz Two-Step Dimming with Configurable Duty Cycle
- Fault Indication for LED Short (to GND and Battery) or Open Fault, Output Over-Voltage Protection (OVP), and Thermal Shutdown (TSD)
- Over-Current Protection (OCP) with Latch Functionality
- Configurable Thermal Derating via NTC Remote Temperature Sensing
- EMI Reduction Technique
- Available in a QFN-19 (3mmx4mm) Wettable Flank Package
- Available in AEC-Q100 Grade 1

APPLICATIONS

- Turn Indicator Lights
- Daytime Running Lights (DRLs)
- Fog Lights
- Rear Lights

All MPS parts are lead-free, halogen-free, and adhere to the RoHS directive. For MPS green status, please visit the MPS website under Quality Assurance. "MPS", the MPS logo, and "Simple, Easy Solutions" are trademarks of Monolithic Power Systems, Inc. or its subsidiaries.

TYPICAL APPLICATION

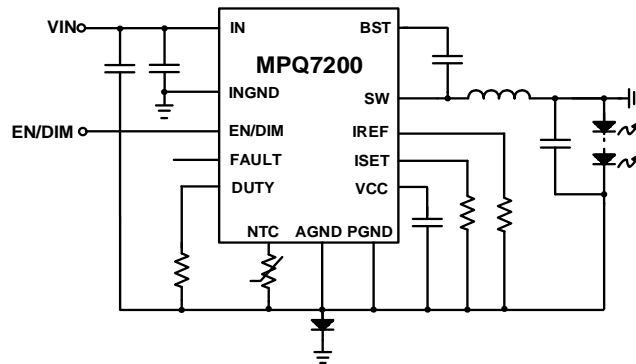

Figure 1: Buck-Boost Topology ($R_{IREF} \leq 9.09k\Omega$)

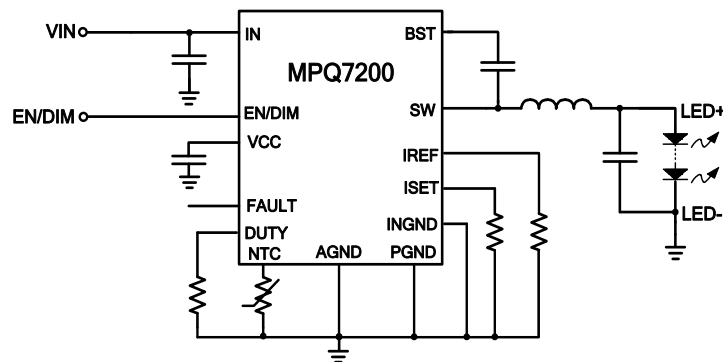

Figure 2: Buck Topology ($R_{IREF} \geq 14.7k\Omega$)

ORDERING INFORMATION

Part Number*	Package	Top Marking	MSL Rating**
MPQ7200GLE***	QFN-19 (3mmx4mm)	See Below	1
MPQ7200GLE-AEC1***			

* For Tape & Reel, add suffix -Z (e.g. MPQ7200GLE-AEC1-Z).

** Moisture Sensitivity Level Rating

*** Wettable Flank

TOP MARKING

MPYW

7200

LLL

E

MP: MPS prefix
 Y: Year code
 W: Week code
 7200: First four digits of the part number
 LLL: Lot number
 E: Wettable flank

PACKAGE REFERENCE

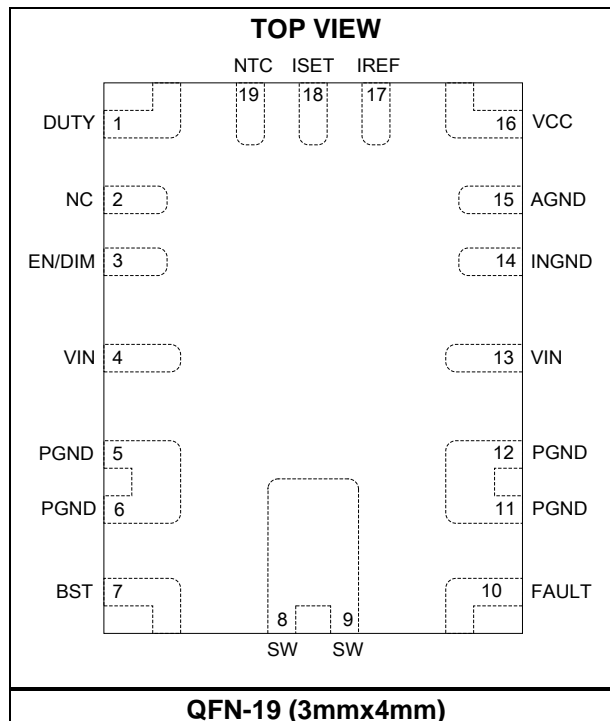

PIN FUNCTIONS

Pin #	Name	Description
1	DUTY	Two-step dimming duty set. Connect a resistor (R_{DUTY}) between DUTY and AGND to set the duty cycle for two-step dimming (or disable two-step dimming). The two-step dimming duty cycle can be set between 5% and 15% with 1% steps (see the Two-Step Dimming section on page 43 for more details). If the DUTY pin is shorted to ground or an open fault is detected before start-up, the part latches off and FAULT is asserted.
2	NC	No connection. Leave the NC pin floating.
3	EN/DIM	Enable/dimming control. When the two-step dimming function is not active ($R_{DUTY} = 4.87k\Omega$), pull ($V_{EN/DIM} - V_{INGND}$) above 2.5V to turn the device on; pull ($V_{EN/DIM} - V_{INGND}$) below 1.58V for >25ms to turn the device off and reset FAULT. Apply an external clock (100Hz to 2kHz) to the EN/DIM pin for PWM dimming. Connect the EN/DIM and VIN pins using a resistor for automatic start-up (once V_{IN} and V_{CC} exceed their respective UVLO thresholds). In two-step dimming mode, EN control and PWM dimming function is disabled. Pull EN/DIM high for 100% dimming duty; pull it low to select dimming duty set by DUTY pin (see Table 2 on page 44 for more details).
4, 13	VIN	Supply voltage. The MPQ7200 operates from a 6V to 42V input rail. Use a capacitor (C_{IN}) to decouple the input rail. Connect VIN to the input rail using a wide PCB trace.
5, 6, 11, 12	PGND	Power ground. PGND is the reference ground of the power device, including the configuration pins (i.e. NTC), so it requires careful consideration when designing the PCB layout. PGND can be used to dissipate thermal heat.
7	BST	Bootstrap. Connect a capacitor between the SW and BST pins to form a floating supply across the high-side MOSFET driver. Place a resistor between the SW pin and BST capacitor to reduce SW voltage spikes and improve EMI performance.
8, 9	SW	Switch output. This pin is the middle point between the high-side and low-side MOSFETs. Connect this pin using a wide trace with a small SW node to reduce noise coupling and improve EMI.
10	FAULT	Fault indicator. FAULT is an open-drain output with an internal 300k Ω pull-up resistor connected to VIN, and a 4M Ω pull-down resistor connected to INGND. FAULT is pulled low if any of the following faults occur: LED short, LED open, over-temperature protection (OTP), false mode detection, and over-current protection (OCP). FAULT can be connected to VIN using a pull-up resistor.
14	INGND	VIN, EN/DIM, and FAULT ground for buck-boost topologies. If using a buck topology, connect the INGND pin to PGND or AGND.
15	AGND	Analog ground. Logic circuit reference ground. Connect AGND and PGND with an external trace.
16	VCC	Internal bias supply. VCC supplies power to the internal control circuit and gate drivers. Place a $\geq 3\mu F$ decoupling capacitor close to VCC and connect it to ground. Considering the capacitance derating, it is recommended to use a 10 μF /10V or 16V X7R capacitor.
17	IREF	Mode selection and NTC reference current setting. Connect a $\leq 9.09k\Omega$ resistor to IREF to set the MPQ7200 to buck-boost mode; connect a $\geq 14.7k\Omega$ resistor to IREF to set the MPQ7200 buck mode. The IREF voltage is 0.57V. Connect a resistor (R_{IREF}) from IREF to GND to get a reference current ($0.57V / R_{IREF}$). If the IREF pin is shorted to ground or an open fault is detected, the part latches off and asserts FAULT. In buck mode, the current on the NTC pin is 50 times that of the reference current on IREF. In buck-boost mode, the current on the NTC pin is 5 times that of the reference current on IREF.
18	ISET	LED current setting. Connect an external resistor from ISET to ground to set the average LED current. If the ISET pin is shorted to ground or an open fault is detected, the part latches off and asserts FAULT.
19	NTC	Remote temperature sense. Connect NTC to a resistor or to a resistor network connected from NTC pin to PGND to configure the temperature derating starting point. The device provides protections for the following conditions: NTC shorted to PGND, AGND, INGND, or the battery.

ABSOLUTE MAXIMUM RATINGS ⁽¹⁾

$V_{IN} - V_{PGND/AGND}$	-0.3V to +50V
$V_{IN} - V_{INGND}$	-0.3V to +50V
$V_{INGND} - V_{PGND/AGND}$	-0.3V to +50V
$V_{FAULT} - V_{INGND}$	-0.3V to +50V
$V_{EN/DIM} - V_{INGND}$	-0.3V to +5.5V
$V_{SW} - V_{PGND/AGND}$ -0.3V to $V_{IN} - V_{PGND/AGND} + 0.3V$	
V_{BST}	$V_{SW} + 5.5V$
$V_{NTC} - V_{PGND/AGND}$	-0.3V to +50V
All other pins - $V_{PGND/AGND}$	-0.3V to +5.5V
Continuous power dissipation ($T_A = 25^{\circ}C$) ⁽²⁾ ⁽⁴⁾	
QFN-19 (3mmx4mm)	3.9W
Junction temperature	150°C
Lead temperature	260°C
Storage temperature	-65°C to +150°C

ESD Ratings

Human body model (HBM)	±2kV
Charged device mode (CDM)	±750V

Recommended Operating Conditions

Supply voltage ($V_{IN} - V_{PGND}$)	6V to 42V
LED current (I_{LED}) buck-boost mode ..	Up to 1.2A
LED current (I_{LED}) buck mode	Up to 3A
Operating junction temp (T_J)....	-40°C to +150°C

Thermal Resistance	θ_{JA}	θ_{JC}
QFN-19 (3mmx4mm)		
JESD51-7	48	11°C/W ⁽³⁾
EVQ7200-L-00A	32	6.°C/W ⁽⁴⁾

Notes:

- 1) Exceeding these ratings may damage the device.
- 2) The maximum allowable power dissipation is a function of the maximum junction temperature, T_J (MAX), the junction-to-ambient thermal resistance, θ_{JA} , and the ambient temperature, T_A . The maximum allowable continuous power dissipation at any ambient temperature is calculated by P_D (MAX) = $(T_J$ (MAX) - T_A) / θ_{JA} . Exceeding the maximum allowable power dissipation can cause excessive die temperature, and the regulator may go into thermal shutdown. Internal thermal shutdown circuitry protects the device from permanent damage.
- 3) Measured on JESD51-7, 4-layer PCB. The values given in this table are only valid for comparison with other packages and cannot be used for design purposes. These values were calculated in accordance with JESD51-7, and simulated on a specified JEDEC board. They do not represent the performance obtained in an actual application, the value of θ_{JC} shows the thermal resistance from junction-to-case bottom.
- 4) Measured on the MPS standard EVB for the MPQ7200, 2oz., 4-layer PCB.

ELECTRICAL CHARACTERISTICS

$V_{IN} = 13.5V$, $V_{EN} = 2V$, $T_J = -40^{\circ}C$ to $+125^{\circ}C$, typical values are at $T_J = 25^{\circ}C$, buck mode, unless otherwise noted.

Parameter	Symbol	Condition	Min	Typ	Max	Units
Shutdown supply current	I_{IN}	$V_{EN} = 0V$		30	80	μA
Quiescent supply current	I_Q	$V_{EN} = 2V$, no switching, I_{REF} float (excluding I_{REF} and the NTC current)		1.2	2	mA
		FAULT latch			2	mA
HS switch on resistance	$HS_{RDS(ON)}$	$V_{BST-SW} = 5V$, $R_{ISET} = 13.3k\Omega$		44	75	m Ω
		$V_{BST-SW} = 5V$, $R_{ISET} = 40.2k\Omega$		85	150	m Ω
LS switch on resistance	$LS_{RDS(ON)}$	$V_{CC} = 5.2V$, $R_{ISET} = 13.3k\Omega$		40	70	m Ω
		$V_{CC} = 5.2V$, $R_{ISET} = 40.2k\Omega$		80	140	m Ω
Switch leakage	SW_{LKG}	$V_{EN} = 0V$, $V_{SW} = 13.5V$, $T_J = 25^{\circ}C$			1	μA
		$V_{EN} = 0V$, $V_{SW} = 13.5V$			5	μA
Peak current limit ⁽⁵⁾	I_{LIMIT_PEAK}	$R_{ISET} = 40.2k\Omega$	2.65	3.15	3.65	A
		$R_{ISET} = 13.3k\Omega$	5.3	6.3	7.3	A
Zero-current detection ⁽⁵⁾				50		mA
Oscillator frequency	f_{SW}		2000	2300	2600	kHz
Minimum on time ⁽⁵⁾	t_{ON_MIN}			55	80	ns
Minimum off time ⁽⁵⁾	t_{OFF_MIN}			75	100	ns
Maximum duty cycle ⁽⁵⁾	D_{MAX}	Low-dropout mode	95	98		%
Spread spectrum frequency ⁽⁵⁾				15		kHz
Spread spectrum frequency range ⁽⁵⁾				$\pm 10\%$ $\times f_{SW}$		kHz
LED current	I_{LED}	$R_{ISET} = 13.3k\Omega$, $T_J = 25^{\circ}C$ to $100^{\circ}C$	-5%	1.2	+5%	A
		$R_{ISET} = 13.3k\Omega$	-15%		+15%	
LED current threshold for MOSFET cutoff	I_{LED_CUT}			600	700	mA
ISET voltage	V_{ISET}	$I_{ISET} = 45\mu A$	0.578	0.592	0.606	V
ISET current threshold for pin short fault		$I_{LED} < I_{LED_CUT}$	80	120	160	μA
		$I_{LED} > I_{LED_CUT}$	180	220	260	μA
ISET current threshold for pin open fault			0.5	1.4	5	μA
EN rising threshold	V_{EN_RISING}	$V_{EN} - V_{INGND}$	1.2	1.67	2.5	V
EN falling threshold	$V_{EN_FALLING}$	$V_{EN} - V_{INGND}$	1	1.58	2.2	V
EN threshold hysteresis	V_{EN_HYS}	$V_{EN} - V_{INGND}$		100		mV
EN input current	I_{EN}	$V_{EN} - V_{INGND} = 2V$		2	8	μA
		$V_{EN} - V_{INGND} = 0V$		0	0.2	μA

ELECTRICAL CHARACTERISTICS (continued)

$V_{IN} = 13.5V$, $V_{EN} = 2V$, $T_J = -40^{\circ}C$ to $+125^{\circ}C$, typical values are at $T_J = 25^{\circ}C$, buck mode, unless otherwise noted.

Parameter	Symbol	Condition	Min	Typ	Max	Units
EN turn-off delay	$t_{EN-D-OFF}$		10	25	45	ms
V_{IN} under-voltage lockout rising threshold	$INUV_{VTH_R}$	$V_{IN} - V_{INGND}$	5.75	6	6.25	V
V_{IN} under-voltage lockout falling threshold	$INUV_{VTH_F}$	$V_{IN} - V_{INGND}$	4.5	4.9	5.2	V
V_{IN} under-voltage lockout threshold hysteresis	$INUV_{HYS}$	$V_{IN} - V_{INGND}$		1.1		V
VCC under-voltage lockout rising threshold	V_{CC_VTH}	$V_{CC} - V_{AGND}$	4.4	4.7	5	V
VCC under-voltage lockout falling threshold		$V_{CC} - V_{AGND}$	3.4	4.05	4.7	V
VCC under-voltage lockout threshold hysteresis	V_{CC_HYS}	$V_{CC} - V_{AGND}$		650		mV
VCC regulator	V_{CC}	$I_{CC} = 0mA$	4.9	5.1	5.3	V
VCC load regulation		$I_{CC} = 20mA$	4.7			V
VCC max current ability		$V_{CC} = V_{CC_UVLO} + 100mV$, no switching	50	80	120	mA
VCC source current ability ⁽⁵⁾		$V_{CC} = V_{CC_UVLO} + 100mV$, switching		25		mA
DUTY source current	I_{DUTY}	I_{DUTY1}	40	45	50	μA
		I_{DUTY2}	550	600	650	μA
V_{DUTY} threshold maxim		I_{DUTY1} and I_{DUTY2}	3.287	3.355	3.422	V
V_{DUTY} threshold minimum ⁽⁵⁾		I_{DUTY1} and I_{DUTY2}	0.28	0.302	0.33	V
Two-step dimming frequency ⁽⁵⁾				500		Hz
Output over-voltage threshold	OV_{VTH}		16.5	18	19	V
Output under-voltage threshold	UV_{VTH}		0.6	1.1	1.7	V
LED low-current threshold		$I_{LED_SETTING} < I_{LED_CUT}$	45	60	75	mA
		$I_{LED_SETTING} > I_{LED_CUT}$	100	120	150	mA
FAULT assertion delay time during start-up	$t_{FT-D-START}$		25	35	40	ms
FAULT assertion deglitch time after start-up ⁽⁵⁾	t_{FT-D}			20		μs
FAULT assertion low sink-current capability	I_{FAULT_SINK}	$V_{FAULT} = 12V$	10	30	50	mA
		$V_{FAULT} = 0.2V$	5	12		mA
FAULT pull-up resistor			100	300	500	k Ω
FAULT pull-down resistor			2000	4000	6000	k Ω
IREF current for mode detection			200	240	280	μA

ELECTRICAL CHARACTERISTICS *(continued)*

$V_{IN} = 13.5V$, $V_{EN} = 2V$, $T_J = -40^{\circ}C$ to $+125^{\circ}C$, typical values are at $T_J = 25^{\circ}C$, buck mode, unless otherwise noted.

Parameter	Symbol	Condition	Min	Typ	Max	Units
V_{IREF} threshold for mode detection			2.6	2.7	2.8	V
IREF voltage	V_{IREF}	$I_{REF} = 20\mu A$	0.50	0.57	0.63	V
IREF current threshold for pin short detection			60	90	120	μA
IREF current threshold for pin open detection				3	6	μA
NTC source current	I_{NTC1}		4.5	7.6	10	μA
	I_{NTC2}	$V_{NTC} = 1.25V$, $I_{REF} = 20\mu A$	980	1020	1060	μA
NTC voltage for current derating		$I_{LED} = 98\%$ of nominal	-2.5%	1.25	+2.5%	V
		$I_{LED} = 58\%$ of nominal	-2.5%	0.65	+2.5%	V
V_{NTC} OV threshold		V_{NTC1}	1.8	2	2.2	V
V_{NTC} threshold for OTP		V_{NTC2}	0.2	0.38	0.48	V
V_{NTC} deglitch time for OTP		$V_{NTC} = 0.3V$	180	256	320	μs
V_{NTC} UV threshold		V_{NTC2}	0.14	0.18	0.22	V
Thermal shutdown ⁽⁵⁾			155	170	185	$^{\circ}C$

ELECTRICAL CHARACTERISTICS (continued)

$V_{IN} = 13.5V$, $V_{EN} = 2V$, $T_J = -40^{\circ}C$ to $+125^{\circ}C$, typical values are at $T_J = 25^{\circ}C$, buck-boost mode, unless otherwise noted.

Parameter	Symbol	Condition	Min	Typ	Max	Units
Shutdown supply current	I_{IN}	$V_{EN} = 0V$		30	80	μA
Quiescent supply current	I_Q	$V_{EN} = 2V$, no switching, I_{REF} floating (excluding I_{REF} and the NTC current)		1.2	2	mA
		FAULT latch			2	mA
HS switch on resistance	$HS_{RDS(ON)}$	$V_{BST-SW} = 5V$, $R_{ISET} = 13.3k\Omega$		44	75	m Ω
LS switch on resistance	$LS_{RDS(ON)}$	$V_{CC} = 5.2V$, $R_{ISET} = 13.3k\Omega$		40	70	m Ω
Switch leakage	SW_{LKG}	$V_{EN} = 0V$, $V_{SW} = 13.5V$, $T_J = 25^{\circ}C$			1	μA
		$V_{EN} = 0V$, $V_{SW} = 13.5V$			5	μA
Peak current limit ⁽⁵⁾	I_{LIMIT_PEAK}		5.3	6.3	7.3	A
Zero-current detection ⁽⁵⁾				50		mA
Oscillator frequency	f_{SW}		920	1150	1380	kHz
Minimum on time ⁽⁵⁾	t_{ON_MIN}			55	80	ns
Minimum off time ⁽⁵⁾	t_{OFF_MIN}			75	100	ns
Maximum duty cycle ⁽⁵⁾	D_{MAX}	Low dropout	95	98		%
Spread spectrum frequency ⁽⁵⁾				15		kHz
LED current	I_{LED}	$R_{ISET} = 21.5k\Omega$, $T_J = 25^{\circ}C$ to $100^{\circ}C$	-7%	0.75	+7%	A
		$R_{ISET} = 21.5k\Omega$	-15%		+15%	
		$R_{ISET} = 13.3k\Omega$, $T_J = 25^{\circ}C$ to $100^{\circ}C$	-5%	1.2	+5%	A
		$R_{ISET} = 13.3k\Omega$	-15%		+15%	
ISET voltage	V_{ISET}	$I_{ISET} = 45\mu A$	0.578	0.592	0.606	V
Power derating ratio		$V_{IN} = 6.6V$, V_{ISET} with respect to the nominal voltage	91.5	95	98.5	%
		$V_{IN} = 5.3V$, V_{ISET} with respect to the nominal voltage	72.5	76	79.5	%
ISET current threshold for pin short			90	110	130	μA
ISET current threshold for pin open			0.5	1.4	5	μA
EN rising threshold	V_{EN_RISING}	$V_{EN} - V_{INGND}$	1.2	1.67	2.5	V
EN falling threshold	$V_{EN_FALLING}$	$V_{EN} - V_{INGND}$	1.0	1.58	2.2	V
EN threshold hysteresis	V_{EN_HYS}	$V_{EN} - V_{INGND}$		100		mV

ELECTRICAL CHARACTERISTICS (continued)

$V_{IN} = 13.5V$, $V_{EN} = 2V$, $T_J = -40^{\circ}C$ to $+125^{\circ}C$, typical values are at $T_J = 25^{\circ}C$, buck-boost mode, unless otherwise noted.

Parameter	Symbol	Condition	Min	Typ	Max	Units
EN input current	I_{EN}	$V_{EN} = 2V$		2	8	μA
		$V_{EN} = 0V$		0	0.2	μA
EN turn-off delay	$t_{EN-TD-OFF}$		10	25	45	ms
V_{IN} under-voltage lockout rising threshold	$INUV_{VTH_R}$	$V_{IN} - V_{INGND}$	5.75	6	6.25	V
V_{IN} under-voltage lockout falling threshold	$INUV_{VTH_F}$	$V_{IN} - V_{INGND}$	4.5	4.9	5.2	V
V_{IN} under-voltage lockout threshold hysteresis	$INUV_{HYS}$	$V_{IN} - V_{INGND}$		1.1		V
VCC under-voltage lockout rising threshold	V_{CC_VTH}	$V_{CC} - V_{AGND}$	4.4	4.7	5	V
VCC under-voltage lockout falling threshold		$V_{CC} - V_{AGND}$	3.4	4.05	4.7	V
VCC under-voltage lockout threshold hysteresis	V_{CC_HYS}	$V_{CC} - V_{AGND}$		650		mV
VCC regulator	V_{CC}	$I_{CC} = 0mA$	4.9	5.1	5.3	V
VCC load regulation		$I_{CC} = 20mA$	4.7			V
VCC max current ability		$V_{CC} = V_{CC\ UVLO} + 100mV$, no switching	50	80	120	mA
VCC source current ability ⁽⁵⁾		$V_{CC} = V_{CC\ UVLO} + 100mV$, switching		25		mA
DUTY source current	I_{DUTY}	I_{DUTY1}	40	45	50	μA
		I_{DUTY2}	550	600	650	μA
V_{DUTY} threshold max		I_{DUTY1} and I_{DUTY2}	3.287	3.355	3.422	V
V_{DUTY} threshold min ⁽⁵⁾		I_{DUTY1} and I_{DUTY2}	0.28	0.302	0.33	V
Two-step dimming frequency ⁽⁵⁾				500		Hz
Output over-voltage threshold	OV_{VTH}	$V_{INGND} - V_{AGND}$	17	18	19	V
Output under-voltage threshold	UV_{VTH}	$V_{INGND} - V_{AGND}$	1	1.35	1.7	V
V_{IN} load dump protection threshold			38	40	42	V
V_{IN} load dump protection falling threshold			37	39	41	V
V_{IN} load dump protection hysteresis				1		V
Output discharge current for load dump protection		$V_{INGND} - V_{PGND} > 5V$	40	100	180	mA
		$V_{INGND} - V_{PGND} = 1V$	20	45	90	mA
FAULT assertion delay time during start-up	t_{FT-TD_START}		25	35	40	ms
FAULT assertion deglitch time after start-up	t_{FT-D}			20		μs

ELECTRICAL CHARACTERISTICS (continued)

$V_{IN} = 13.5V$, $V_{EN} = 2V$, $T_J = -40^{\circ}C$ to $+125^{\circ}C$, typical values are at $T_J = 25^{\circ}C$, buck-boost mode, unless otherwise noted.

Parameter	Symbol	Condition	Min	Typ	Max	Units
FAULT assertion low sink current capability	I_{FAULT_SINK}	$V_{FAULT} = 12V$	10	30	50	mA
		$V_{FAULT} = 0.2V$	5	12		mA
FAULT pull-up resistor			100	300	500	k Ω
FAULT pull-down resistor			2000	4000	6000	k Ω
IREF current for mode detection			200	240	280	μA
VIREF threshold for mode detection			2.6	2.7	2.8	V
IREF voltage	V_{IREF}	$I_{REF} = 20\mu A$	0.50	0.57	0.63	V
IREF current threshold for pin short detection			600	900	1200	μA
IREF current threshold for pin open detection				40	70	μA
NTC source current	I_{NTC1}		4.5	7.6	10	μA
	I_{NTC2}	$V_{NTC} = 1.25V$, $I_{REF} = 200\mu A$	980	1020	1060	μA
NTC voltage for current derating		ILED = 98% of nominal	-2.5%	1.25	+2.5%	V
		ILED = 58% of nominal	-2.5%	0.65	+2.5%	V
V_{NTC} over-voltage threshold		V_{NTC1}	1.8	2	2.2	V
V_{NTC} threshold for OTP		V_{NTC2}	0.2	0.38	0.48	V
V_{NTC} deglitch time for OTP		$V_{NTC} = 0.3V$	180	256	320	μs
V_{NTC} under-voltage threshold		V_{NTC2}	0.14	0.18	0.22	V
Thermal shutdown ⁽⁵⁾			155	170	185	$^{\circ}C$

Note:

5) Not tested in production. Guaranteed by over-temperature correlation.

TYPICAL CHARACTERISTICS

$V_{IN} = 12V$, $T_J = -40^{\circ}C$ to $+125^{\circ}C$, unless otherwise noted

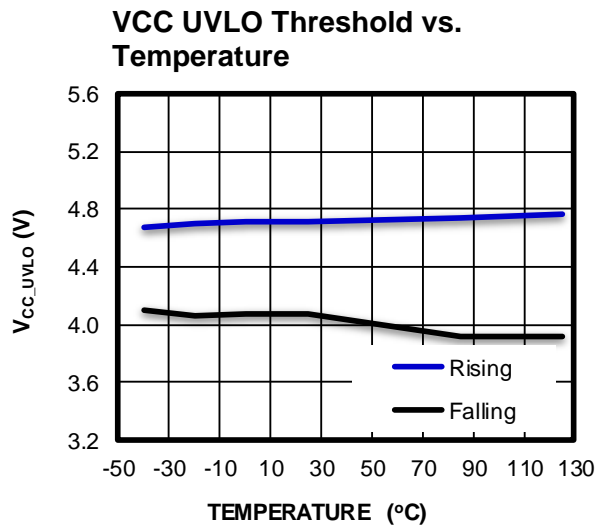
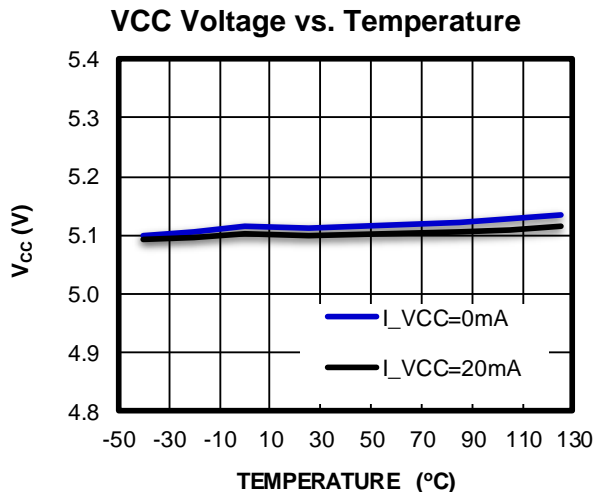
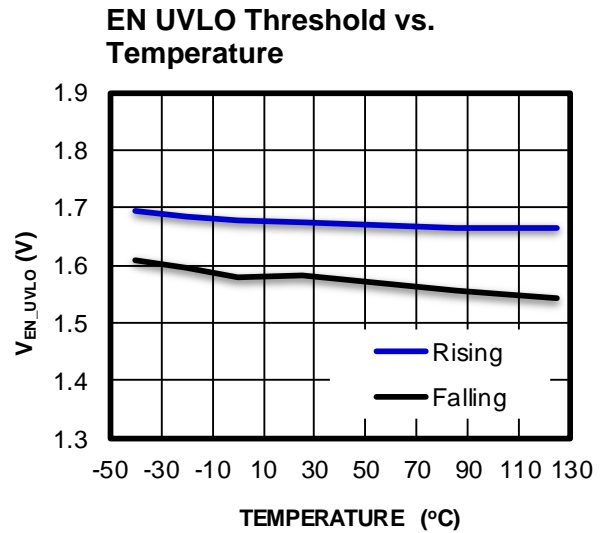
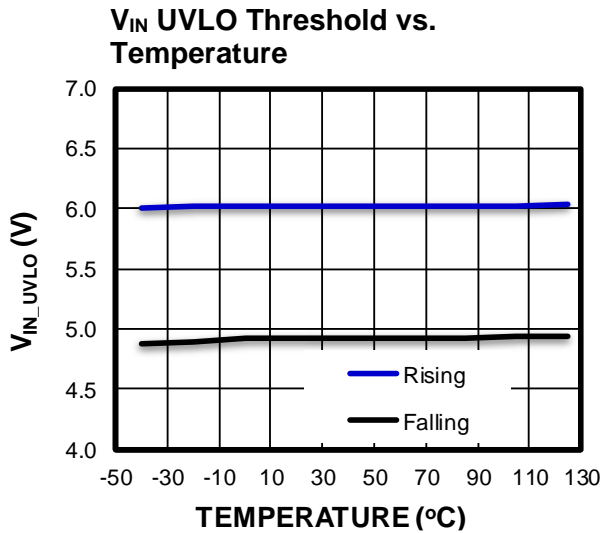
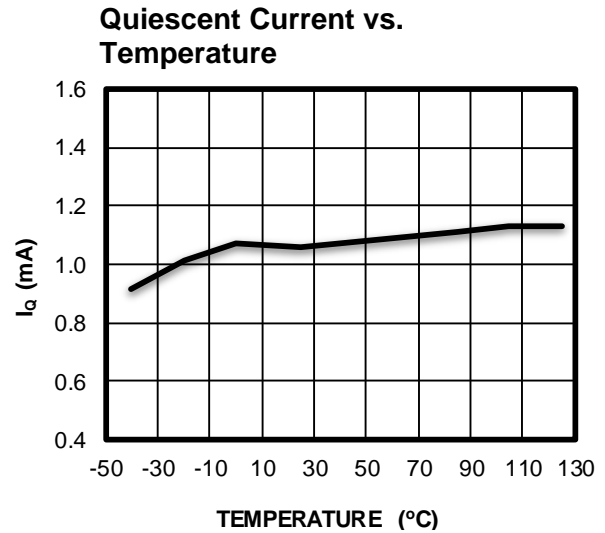
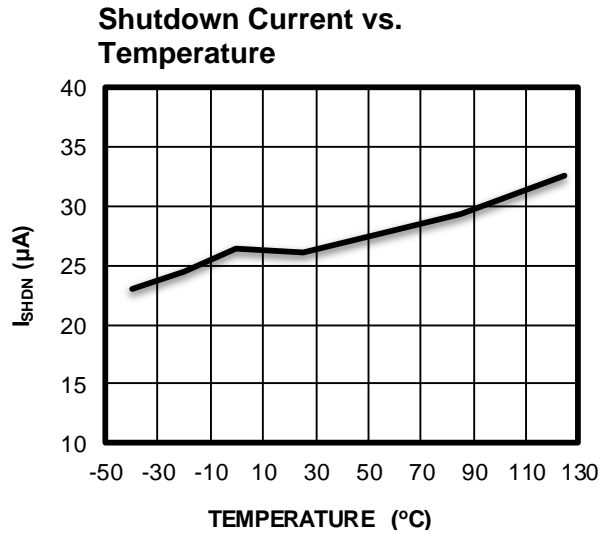

TYPICAL CHARACTERISTICS (continued)
 $V_{IN} = 12V$, $T_J = -40^{\circ}C$ to $+125^{\circ}C$, unless otherwise noted

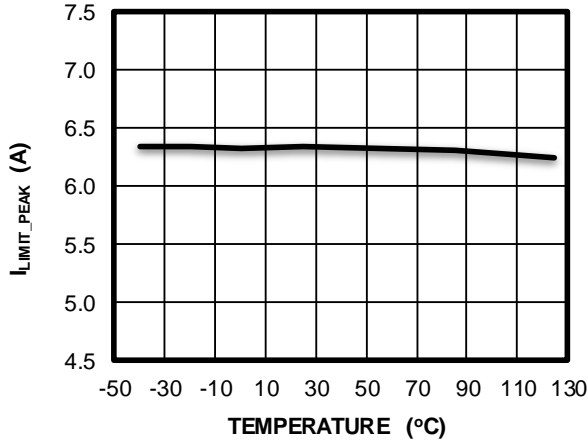
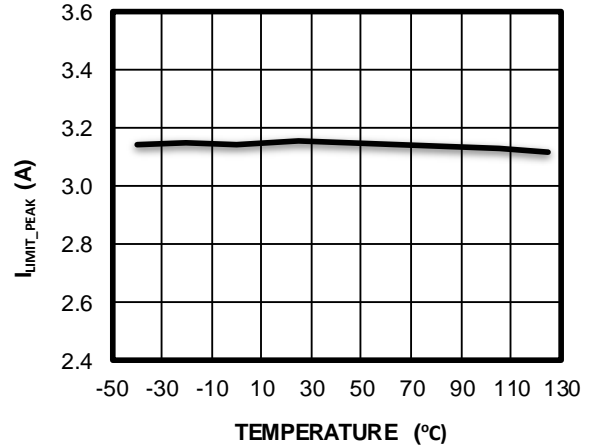
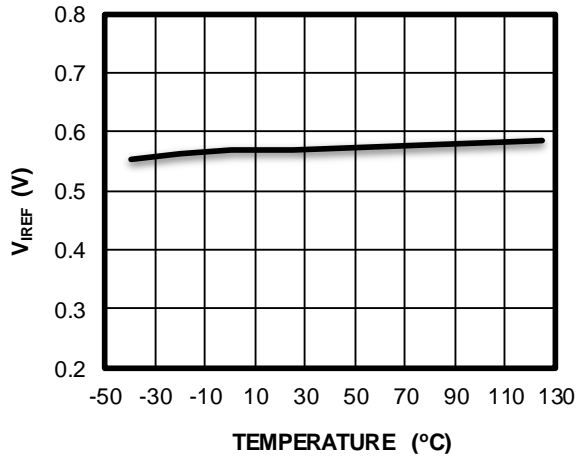
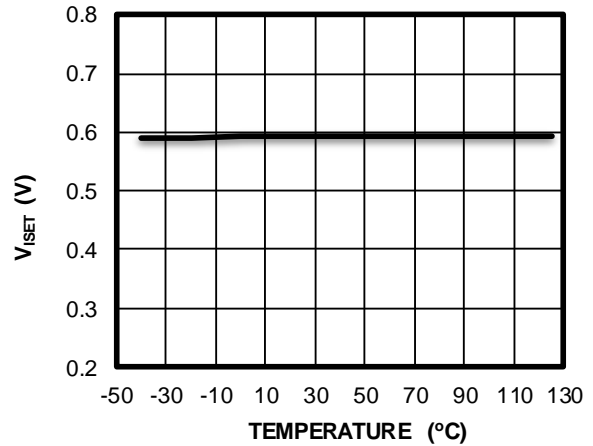
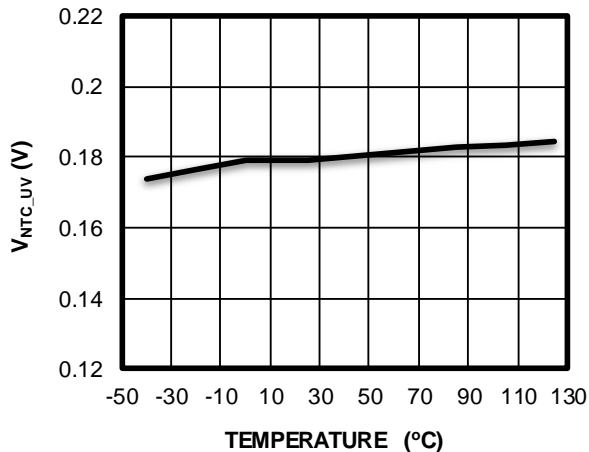
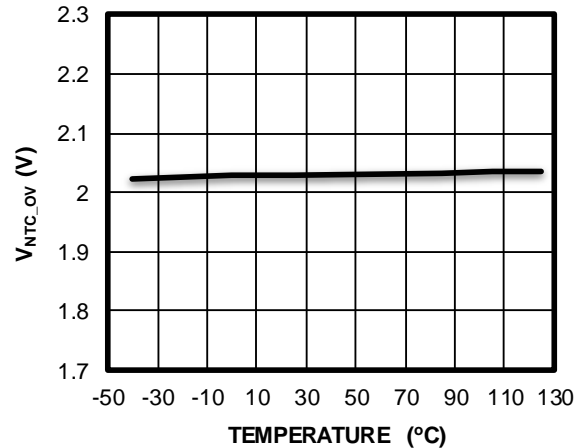
Current Limit with MOSFETs Fully On vs. Temperature

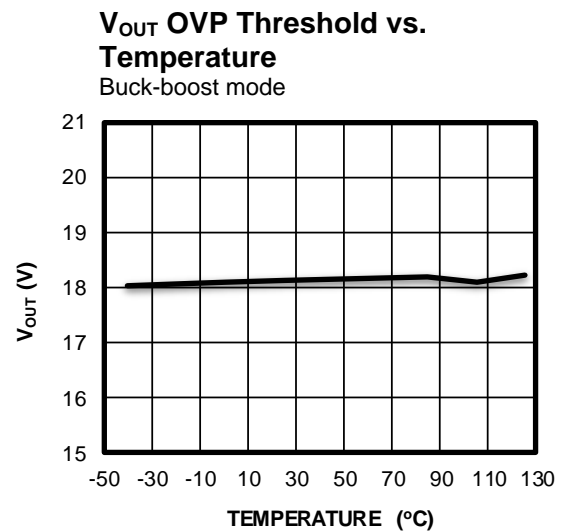
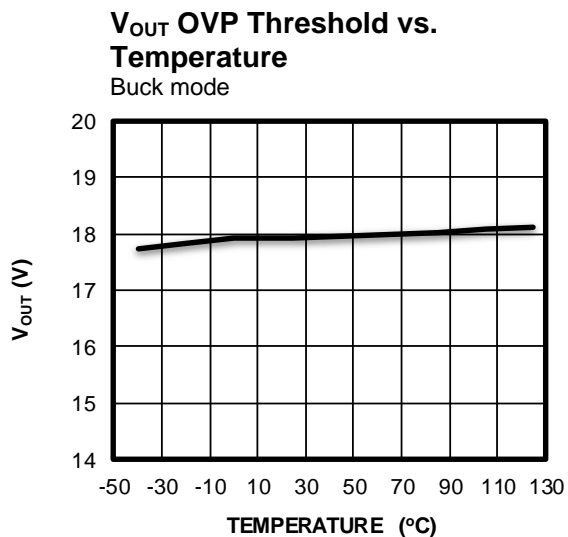
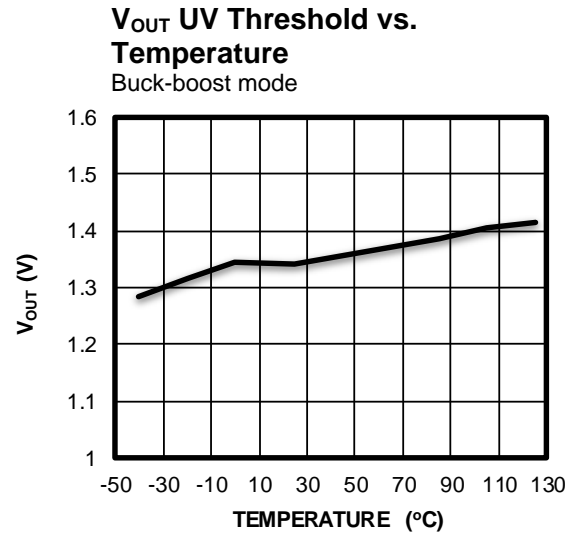
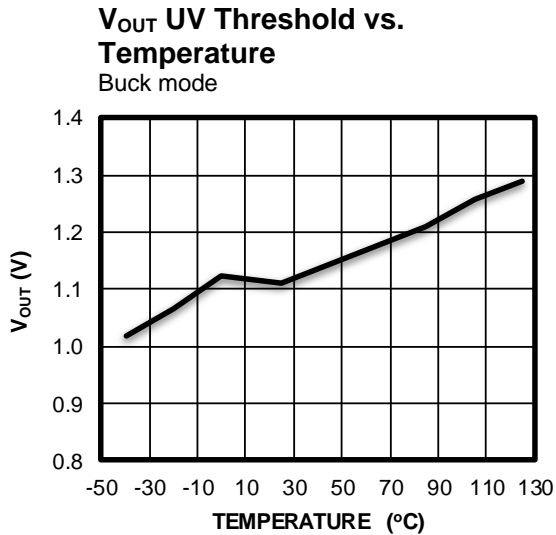
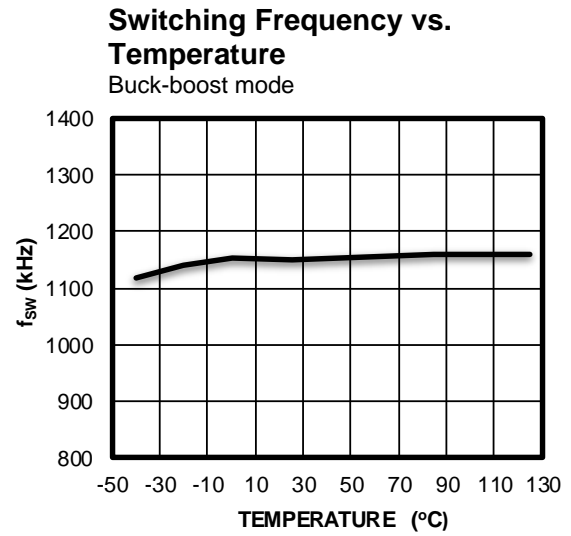
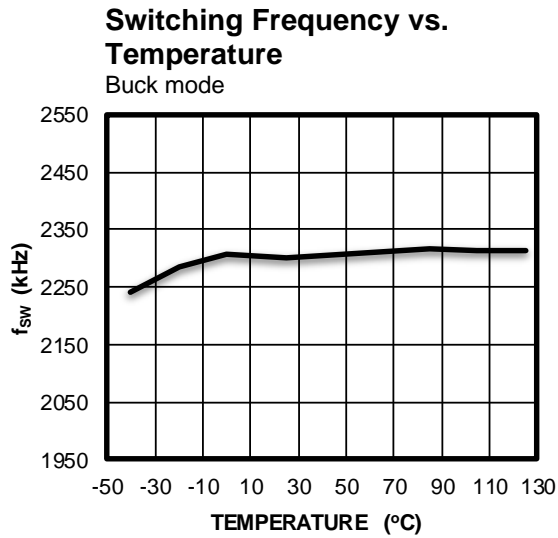
Current Limit with MOSFETs Half On vs. Temperature

 V_{IREF} vs. Temperature

 V_{ISET} vs. Temperature

 V_{NTC_UV} Threshold vs. Temperature

 V_{NTC_OV} Threshold vs. Temperature

TYPICAL CHARACTERISTICS (continued)
 $V_{IN} = 12V$, $T_J = -40^{\circ}C$ to $+125^{\circ}C$, unless otherwise noted

TYPICAL PERFORMANCE CHARACTERISTICS *(continued)*

Buck mode, 2 LEDs ($V_{LED} = 6V$), $V_{IN} = 13.5V$, $f_{SW} = 2.3MHz$, $L = 4.7\mu H$, $T_A = 25^\circ C$, unless otherwise noted.

I_{LED} Part-to-Part Variation

$T_J = 25^\circ C$ to $100^\circ C$

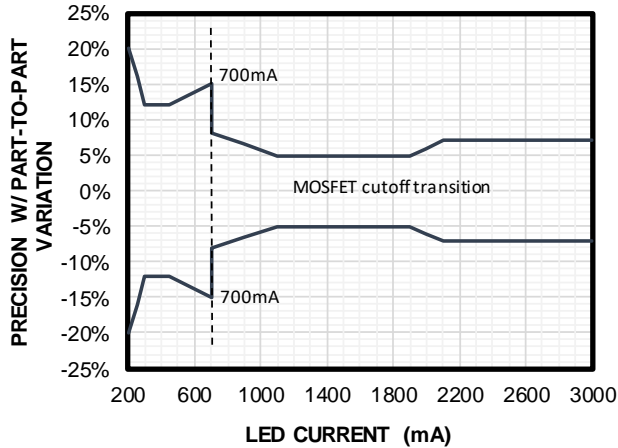

I_{LED} Part-to-Part Variation

$T_J = -40^\circ C$ to $+150^\circ C$

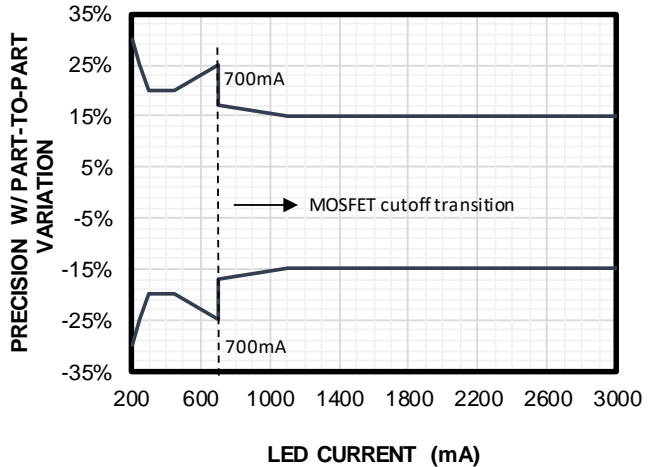

I_{LED} Precision vs. Input Voltage

$L = 4.7\mu H$, $I_{LED} = 1.2A$, V_{IN} ramping up

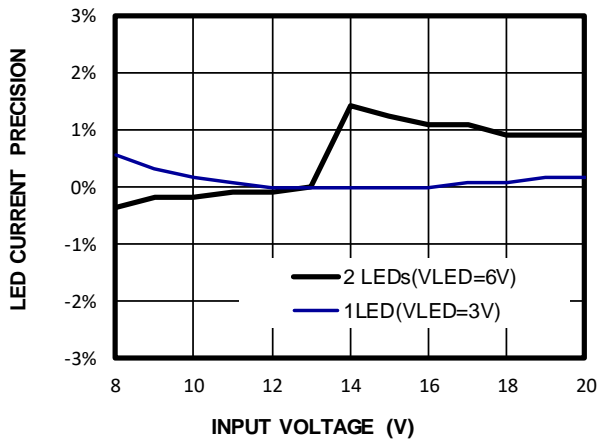

I_{LED} Precision vs. Input Voltage

$L = 4.7\mu H$, $I_{LED} = 1.2A$, V_{IN} ramping down

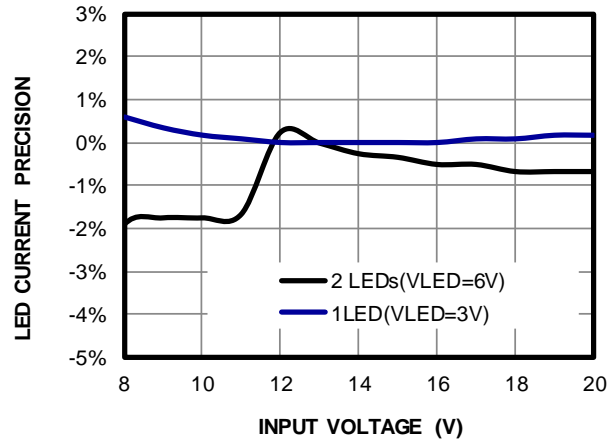

I_{LED} Precision vs. Input Voltage

$L = 3.3\mu H$, $I_{LED} = 2A$, V_{IN} ramping up

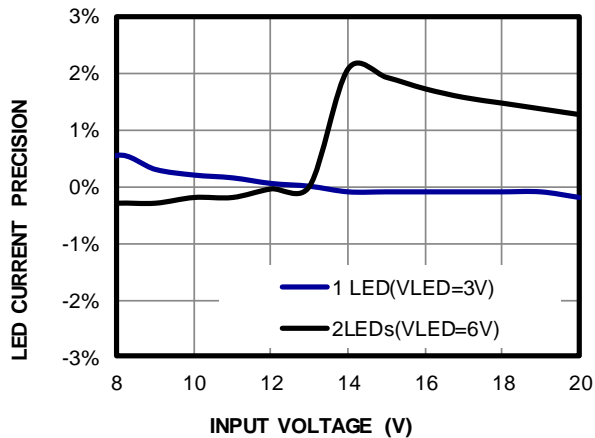

I_{LED} Precision vs. Input Voltage

$L = 3.3\mu H$, $I_{LED} = 2A$, V_{IN} ramping down

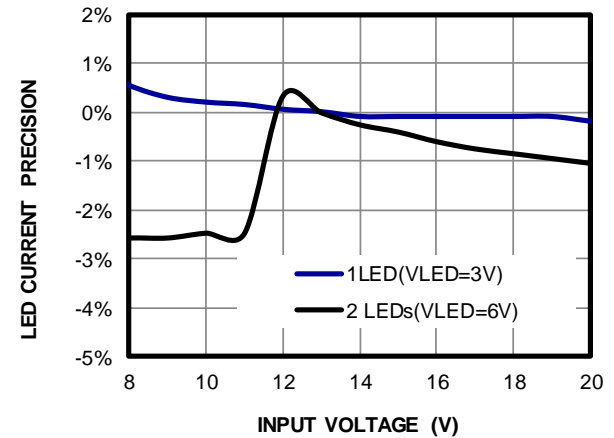

TYPICAL PERFORMANCE CHARACTERISTICS *(continued)*

Buck mode, 2 LEDs ($V_{LED} = 6V$), $V_{IN} = 13.5V$, $f_{SW} = 2.3MHz$, $L = 4.7\mu H$, $T_A = 25^\circ C$, unless otherwise noted.

I_{LED} Precision vs. Input Voltage

$L = 6.8\mu H$, $I_{LED} = 0.75A$, V_{IN} ramping up

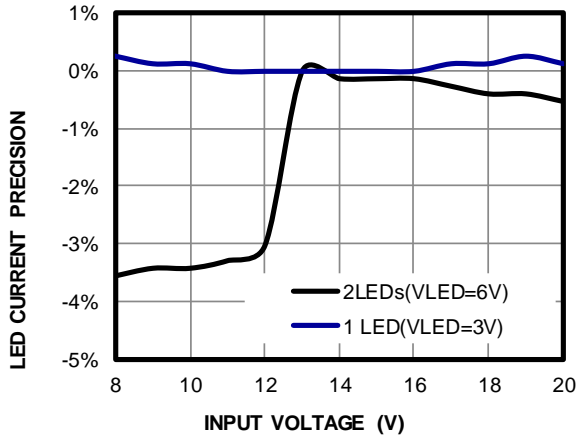

I_{LED} Precision vs. Input Voltage

$L = 6.8\mu H$, $I_{LED} = 0.75A$, V_{IN} ramping down

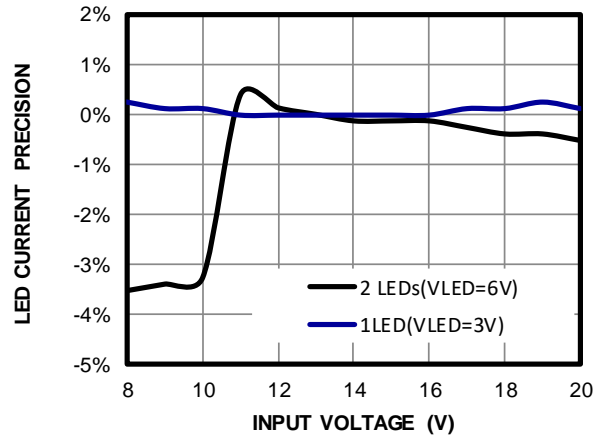

I_{LED} Precision vs. Input Voltage

$L = 10\mu H$, $I_{LED} = 0.35A$, V_{IN} ramping up

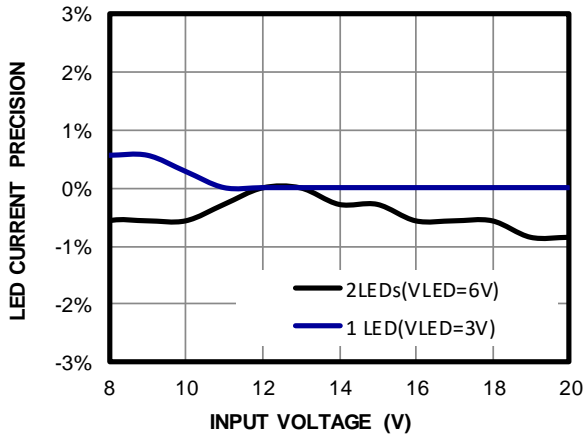

I_{LED} Precision vs. Input Voltage

$L = 10\mu H$, $I_{LED} = 0.35A$, V_{IN} ramping down

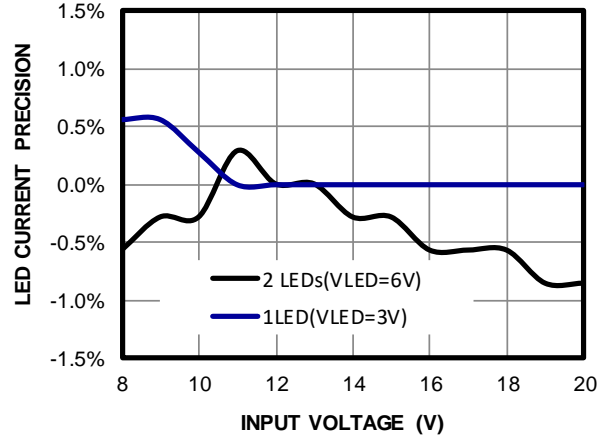

I_{LED} Precision vs. Input Voltage

$L = 15\mu H$, $I_{LED} = 0.2A$, V_{IN} ramping up

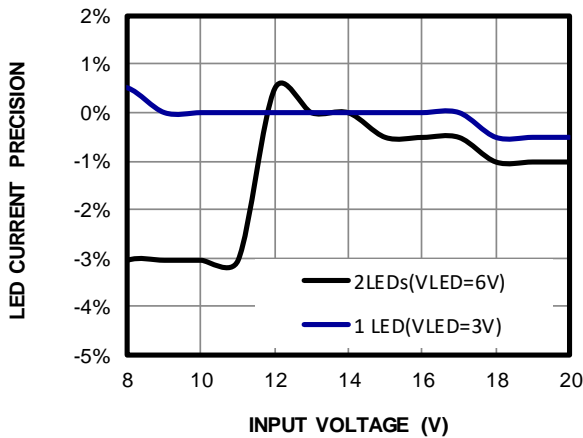

I_{LED} Precision vs. Input Voltage

$L = 15\mu H$, $I_{LED} = 0.2A$, V_{IN} ramping down

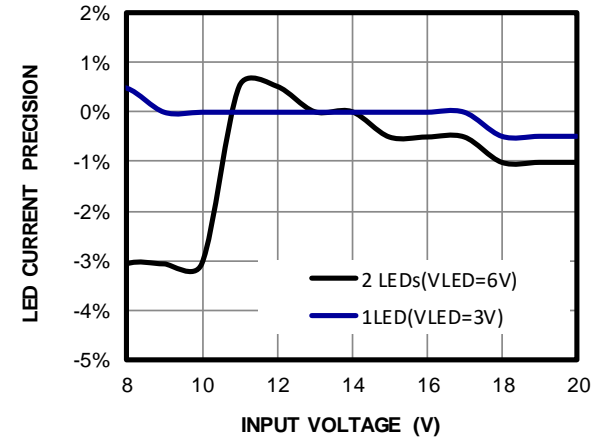

TYPICAL PERFORMANCE CHARACTERISTICS (continued)

Buck mode, 2 LEDs ($V_{LED} = 6V$), $V_{IN} = 13.5V$, $f_{SW} = 2.3MHz$, $L = 4.7\mu H$, $T_A = 25^\circ C$, unless otherwise noted.

I_{LED} Precision vs. Inductor Value Variation

$V_{IN} = 13.5V$, 2 LEDs ($V_{LED} = 6V$)

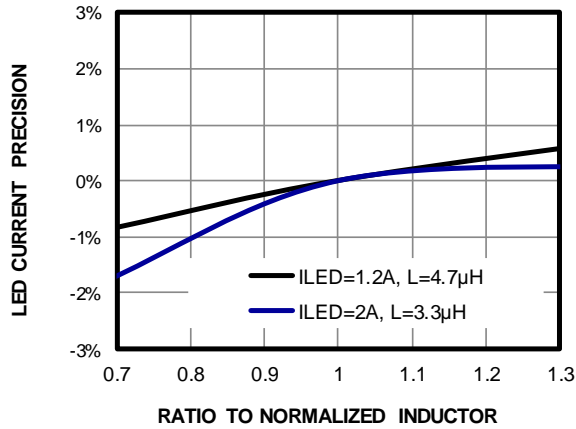

I_{LED} Precision vs. Inductor Value Variation

$V_{IN} = 13.5V$, 1 LED ($V_{LED} = 3V$)

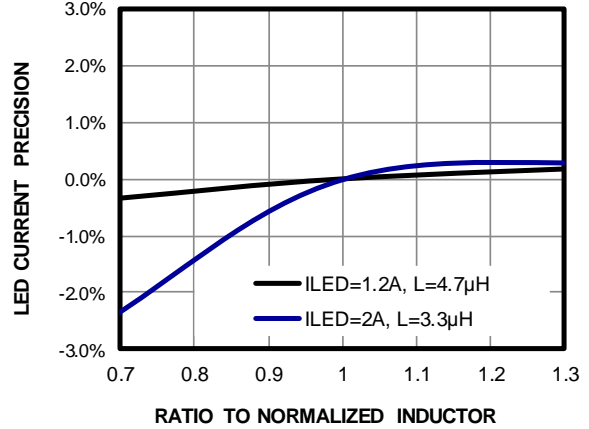

I_{LED} Precision vs. HS-FET Temperature Sense

2 LEDs ($V_{LED} = 6V$)

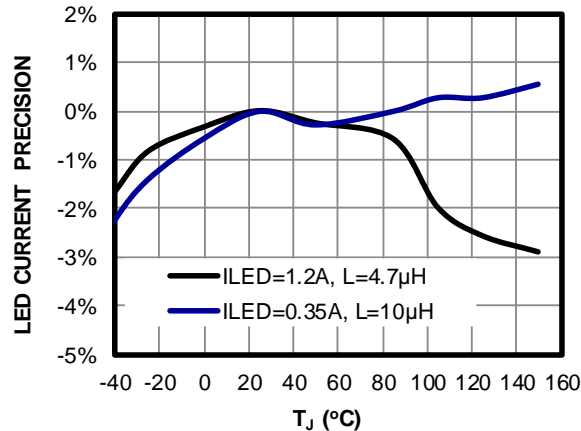

I_{LED} Precision vs. LS-FET Temperature Sense

2 LEDs ($V_{LED} = 6V$)

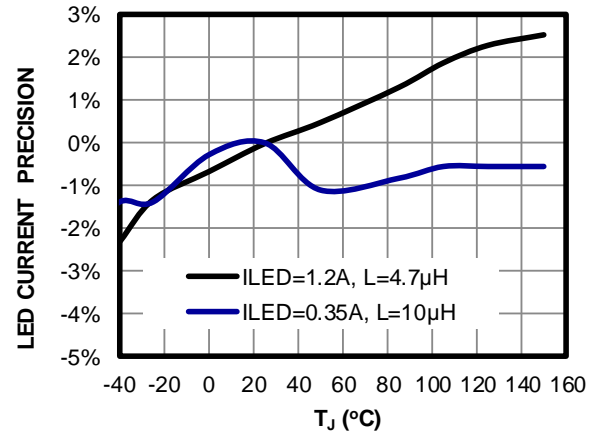

V_{IN} Slow Ramp Up and Down

2 LEDs ($V_{LED} = 6V$), $I_{LED} = 1.2A$,
 $V_{IN} = 0V$ to $20V$, $0.001V/ms$

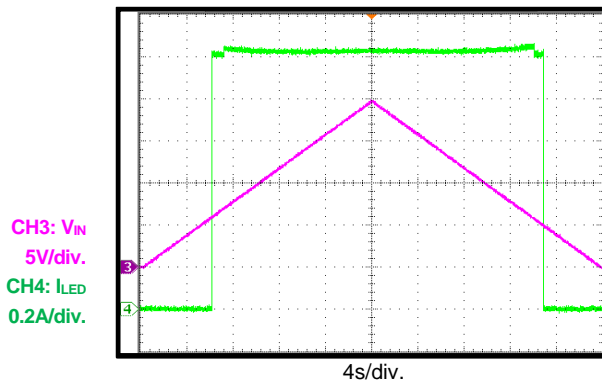

V_{IN} Slow Ramp Up and Down

1 LED ($V_{LED} = 3V$), $I_{LED} = 1.2A$,
 $V_{IN} = 0V$ to $20V$, $0.001V/ms$

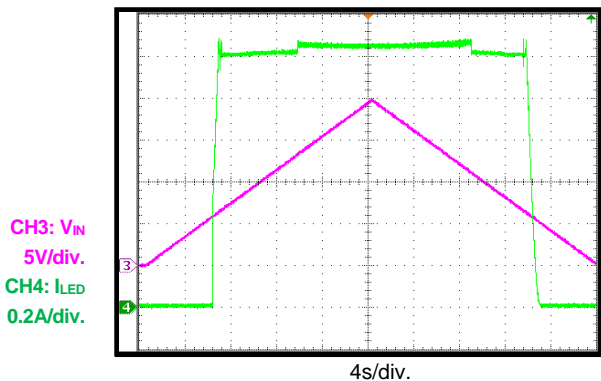

TYPICAL PERFORMANCE CHARACTERISTICS *(continued)*

Buck mode, $V_{IN} = 12V$, 2 LEDs in series ($V_{LED} = 6V$), $I_{LED} = 3A$, $L = 4.7\mu H$, $f_{SW} = 2.3MHz$, with EMI filters, $T_A = 25^\circ C$, unless otherwise noted. ⁽⁶⁾

CISPR25 Class 5 Peak Conducted Emissions

150kHz to 108MHz

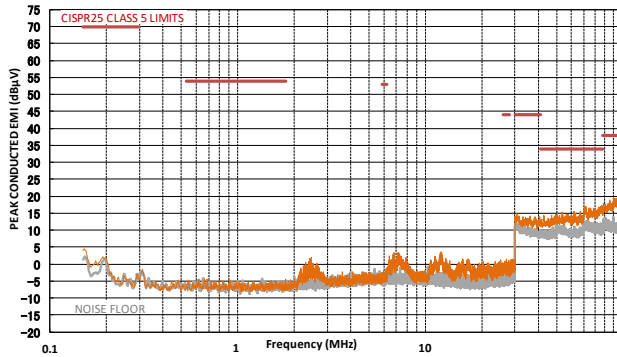

CISPR25 Class 5 Average Conducted Emissions

150kHz to 108MHz

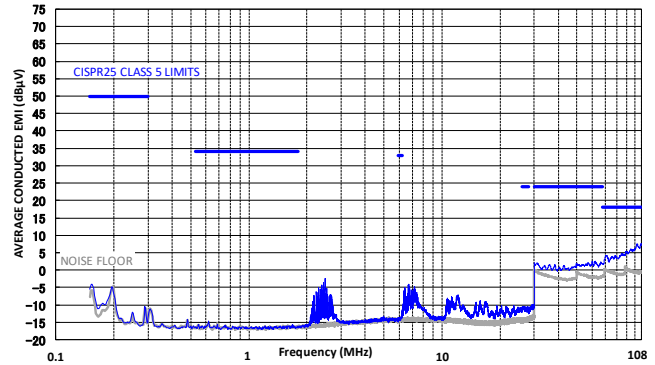

CISPR25 Class 5 Peak Radiated Emissions

150kHz to 30MHz

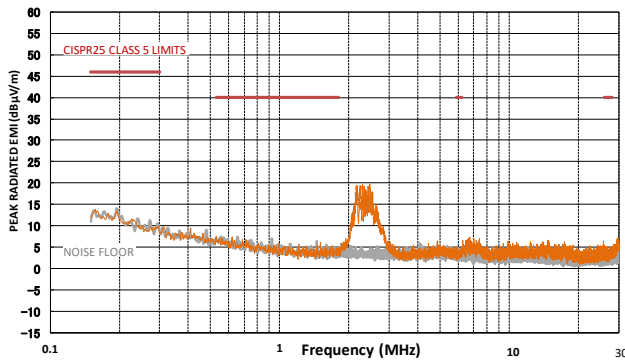

CISPR25 Class 5 Average Radiated Emissions

150kHz to 30MHz

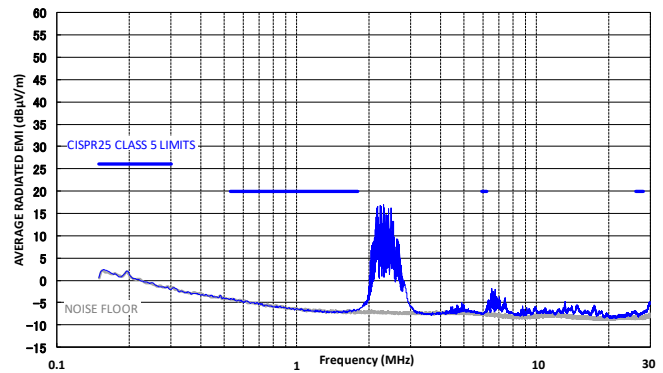

CISPR25 Class 5 Peak Radiated Emissions

Horizontal, 30MHz to 200MHz

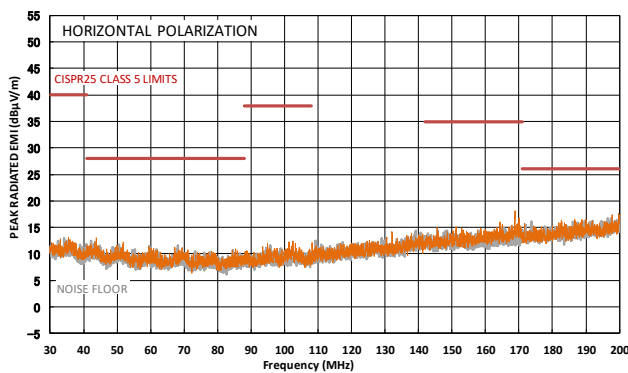

CISPR25 Class 5 Average Radiated Emissions

Horizontal, 30MHz to 200MHz

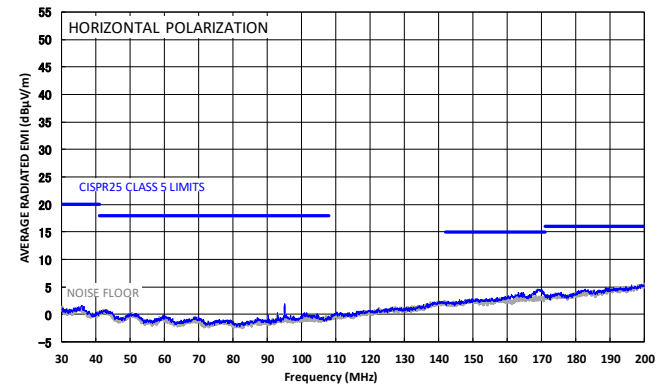

TYPICAL PERFORMANCE CHARACTERISTICS *(continued)*

Buck mode, $V_{IN} = 12V$, 2 LEDs in series ($V_{LED} = 6V$), $I_{LED} = 3A$, $L = 4.7\mu H$, $f_{SW} = 2.3MHz$, with EMI filters, $T_A = 25^\circ C$, unless otherwise noted. ⁽⁶⁾

CISPR25 Class 5 Peak Radiated Emissions

Vertical, 30MHz to 200MHz

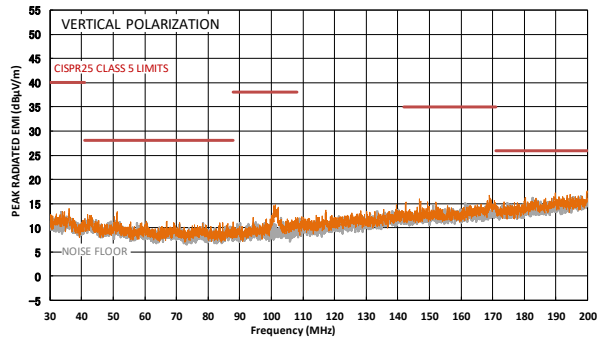

CISPR25 Class 5 Average Radiated Emissions

Vertical, 30MHz to 200MHz

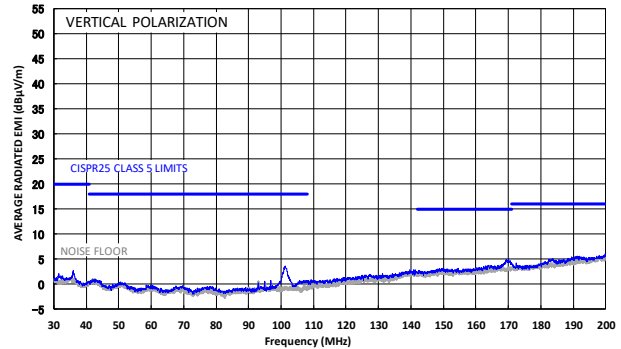

CISPR25 Class 5 Peak Radiated Emissions

Horizontal, 200MHz to 1GHz

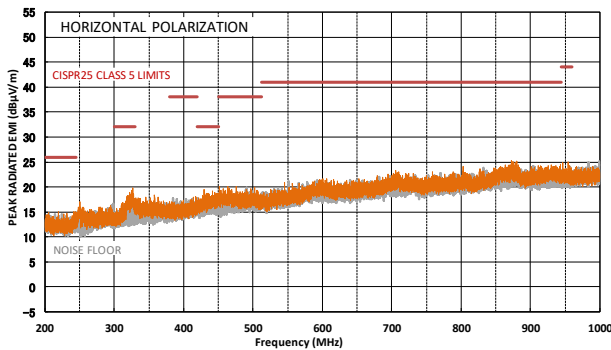

CISPR25 Class 5 Average Radiated Emissions

Horizontal, 200MHz to 1GHz

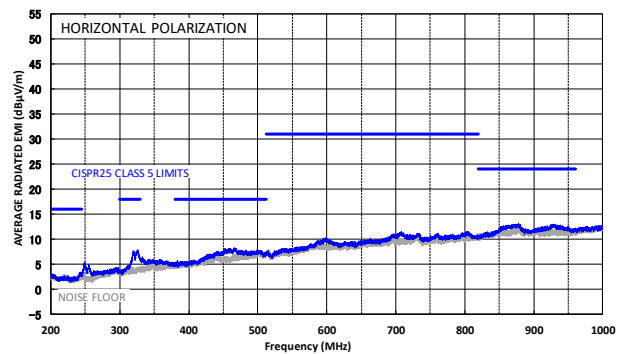

CISPR25 Class 5 Peak Radiated Emissions

Vertical, 200MHz to 1GHz

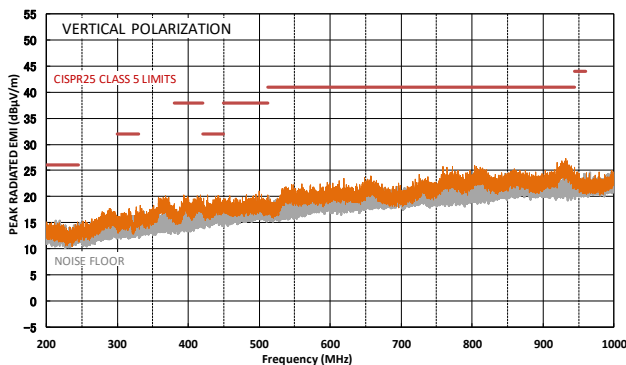

CISPR25 Class 5 Average Radiated Emissions

Vertical, 200MHz to 1GHz

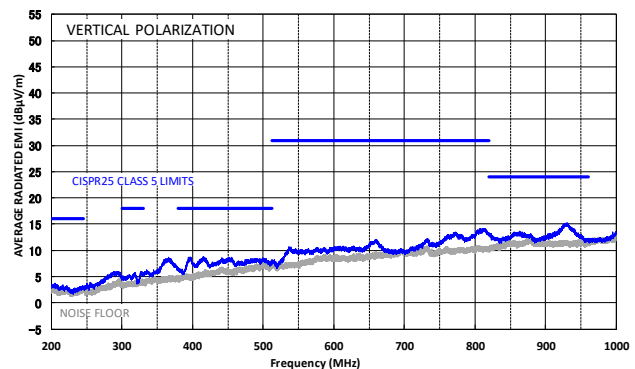

Note:

6) The MPQ7200 buck mode EMC test results are based on the application circuit with EMI filters in Figure 10 on page 54.

TYPICAL PERFORMANCE CHARACTERISTICS *(continued)*

Buck mode, 2 LEDs in series ($V_{LED} = 6V$), $V_{IN} = 13.5V$, $f_{SW} = 2.3MHz$, $L = 4.7\mu H$, $T_A = 25^\circ C$, unless otherwise noted.

Efficiency with 2 LEDs

2 LEDs ($V_{LED} = 6V$), $R_{BST} = 0\Omega$,
MOSFETs cut off when $I_{LED} = 0.5A$

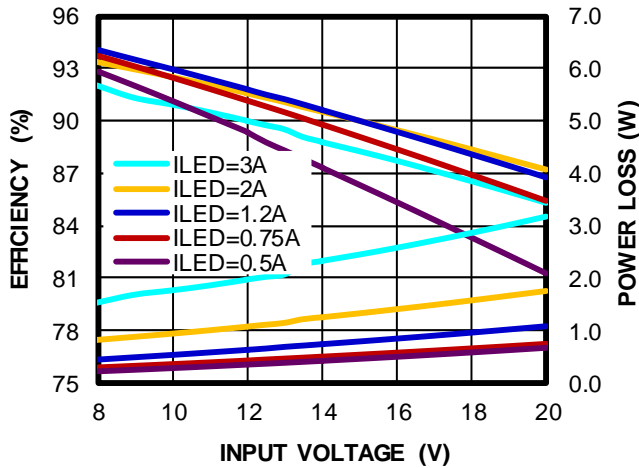

Efficiency with 1 LED

1 LED ($V_{LED} = 3V$), $R_{BST} = 0\Omega$,
MOSFETs cut off when $I_{LED} = 0.5A$

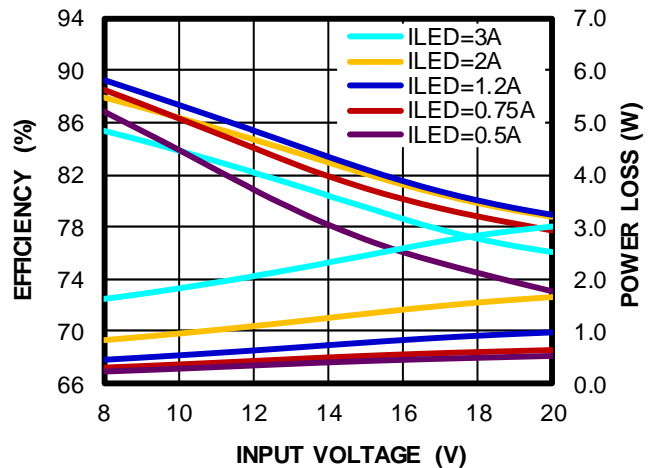

Case Temperature Rise with 2 LEDs

2 LEDs ($V_{LED} = 6V$), $R_{BST} = 0\Omega$,
MOSFETs cut off when $I_{LED} = 0.5A$

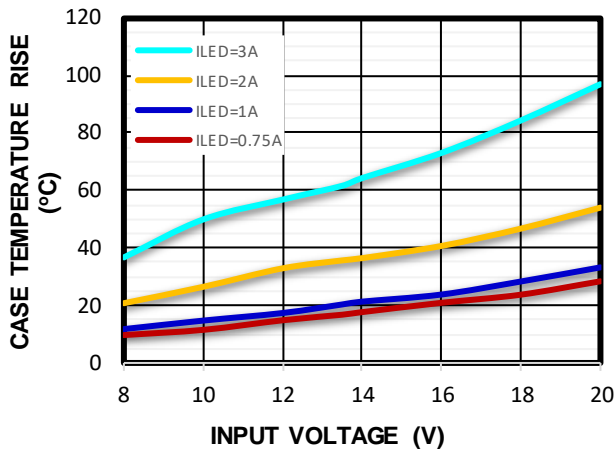

Case Temperature Rise with 1 LED

1 LED ($V_{LED} = 3V$), $R_{BST} = 0\Omega$,
MOSFETs cut off when $I_{LED} = 0.5A$

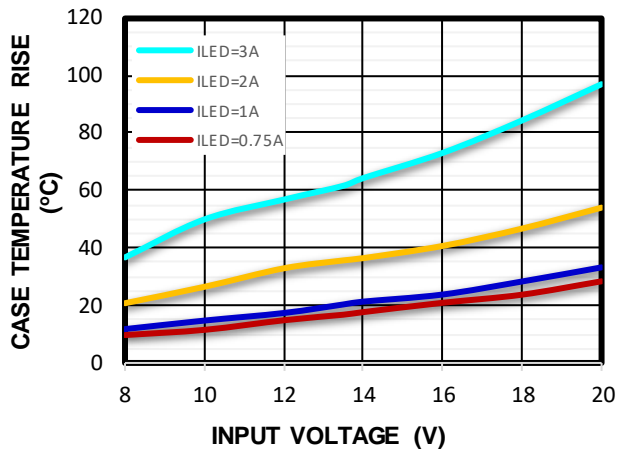

Steady State

$I_{LED} = 3A$

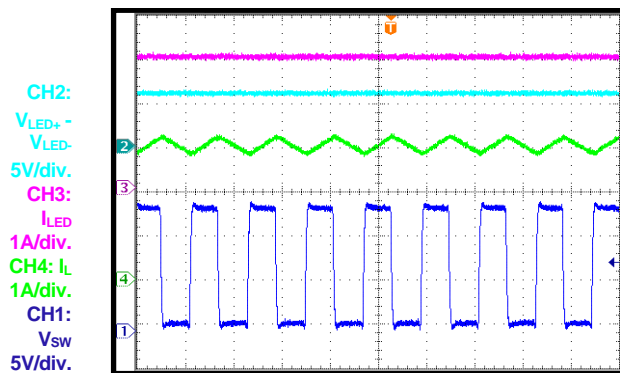

400ns/div.

Start-Up through V_{IN}

$I_{LED} = 3A$

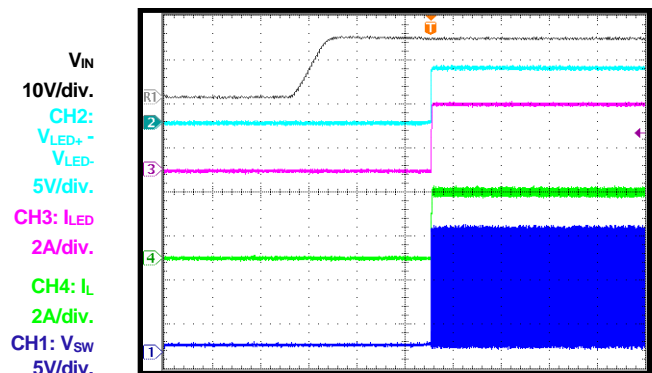

2ms/div.

TYPICAL PERFORMANCE CHARACTERISTICS *(continued)*

Buck mode, 2 LEDs ($V_{LED} = 6V$), $V_{IN} = 13.5V$, $f_{SW} = 2.3MHz$, $L = 4.7\mu H$, $T_A = 25^\circ C$, unless otherwise noted.

Shutdown through VIN

$I_{LED} = 3A$

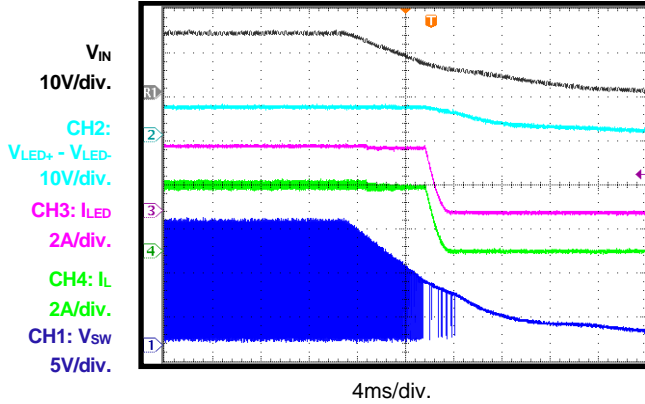

Start-Up through EN

$I_{LED} = 3A$

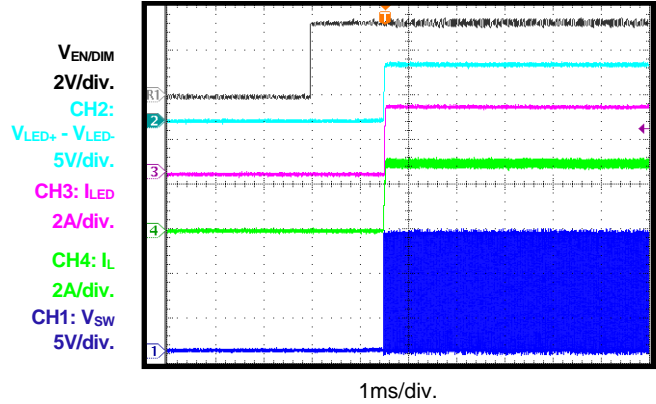

Shutdown through EN

$I_{LED} = 3A$

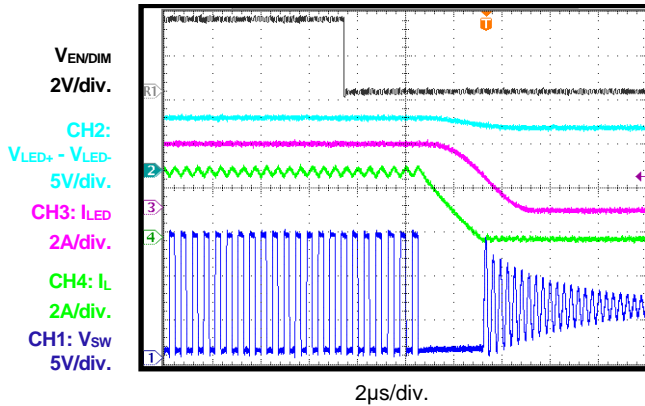

PWM Dimming Steady State

Dimming frequency = 100Hz

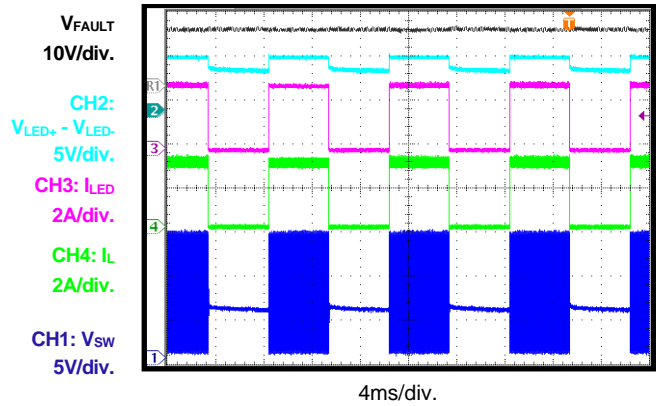

PWM Dimming in Steady State

Dimming frequency = 500Hz

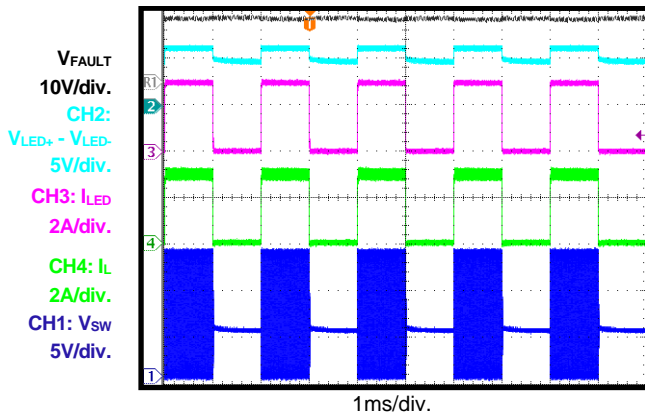

PWM Dimming

Start-up through VIN

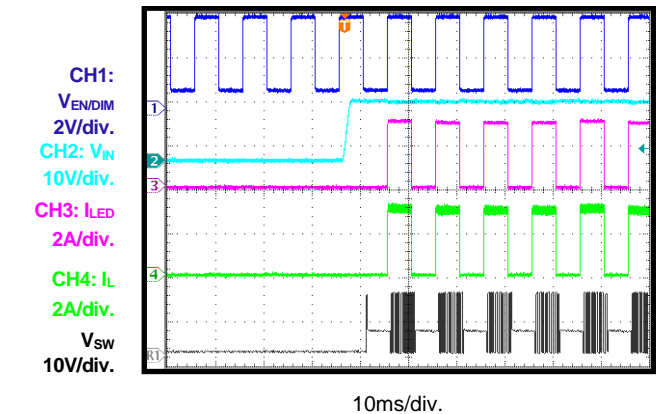

TYPICAL PERFORMANCE CHARACTERISTICS *(continued)*

Buck mode, 2 LEDs ($V_{LED} = 6V$), $V_{IN} = 13.5V$, $f_{SW} = 2.3MHz$, $L = 4.7\mu H$, $T_A = 25^\circ C$, unless otherwise noted.

PWM Dimming
Shutdown through VIN

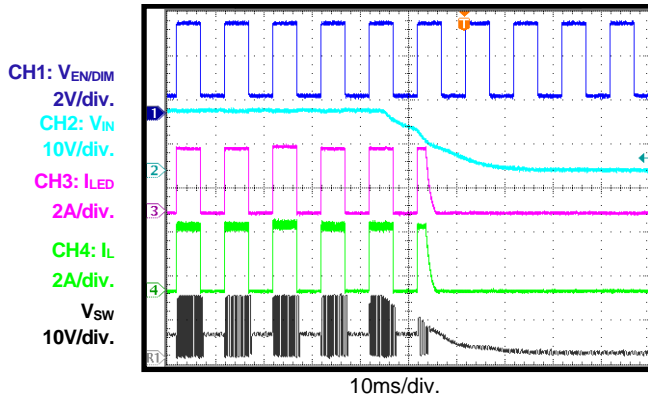

Two-Step Dimming
Steady state

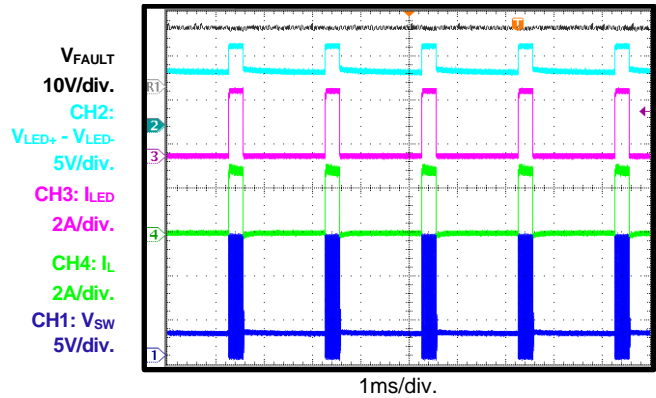

Two-Step Dimming
Start-up through VIN

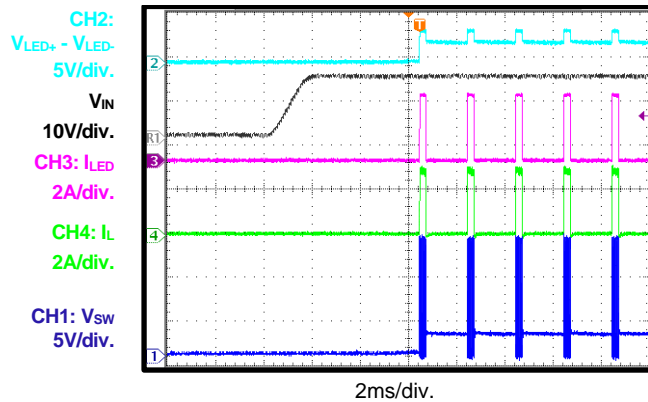

Two-Step Dimming
Shutdown through VIN

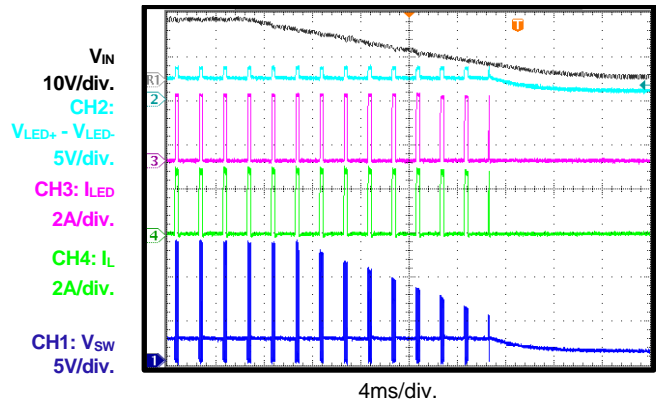

No Dimming
LED open start-up

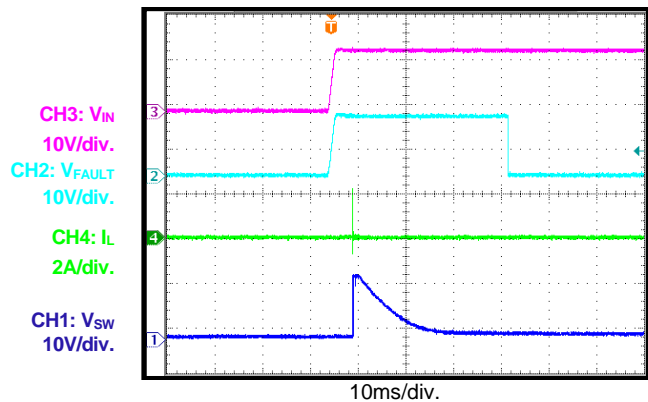

No Dimming
LED open entry

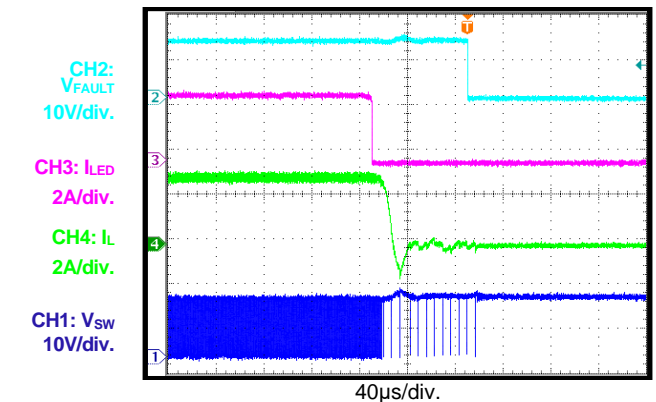

TYPICAL PERFORMANCE CHARACTERISTICS *(continued)*

Buck mode, 2 LEDs ($V_{LED} = 6V$), $V_{IN} = 13.5V$, $f_{SW} = 2.3MHz$, $L = 4.7\mu H$, $T_A = 25^\circ C$, unless otherwise noted.

PWM Dimming
LED open start-up

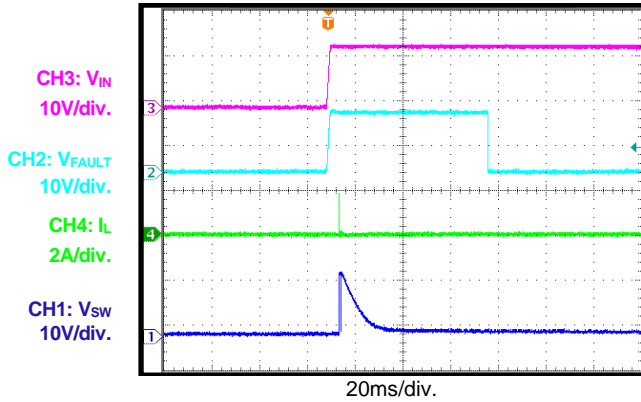

PWM Dimming
LED open entry

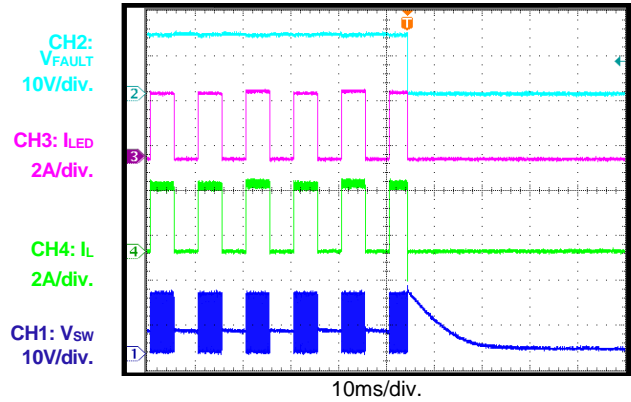

Two-Step Dimming
LED open start-up

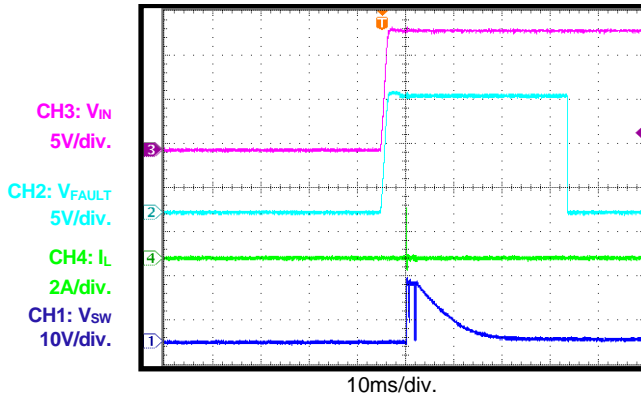

Two-Step Dimming
LED open entry

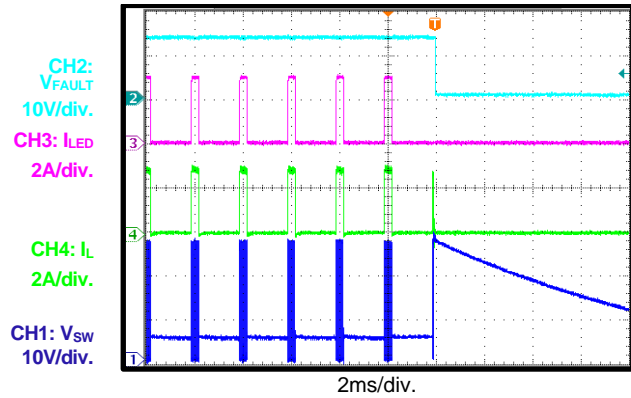

No Dimming
LED+ short to LED- start-up

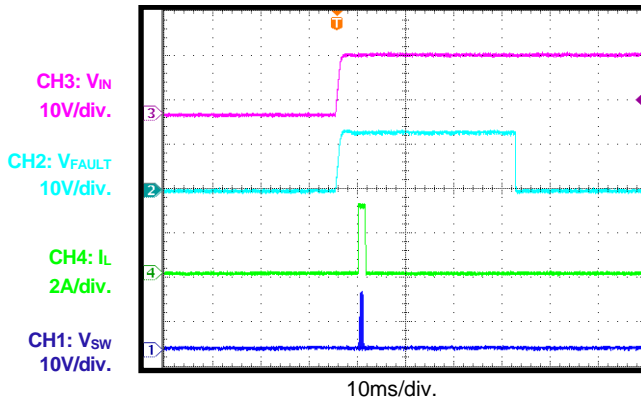

No Dimming
LED+ short to LED- entry

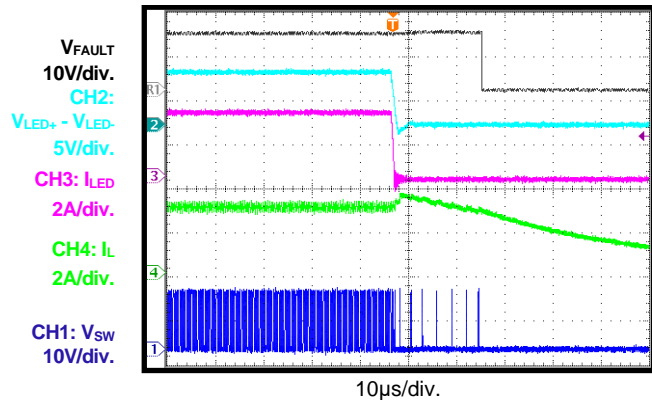

TYPICAL PERFORMANCE CHARACTERISTICS *(continued)*

Buck mode, 2 LEDs ($V_{LED} = 6V$), $V_{IN} = 13.5V$, $f_{SW} = 2.3MHz$, $L = 4.7\mu H$, $T_A = 25^\circ C$, unless otherwise noted.

PWM Dimming

LED+ short to LED- start-up

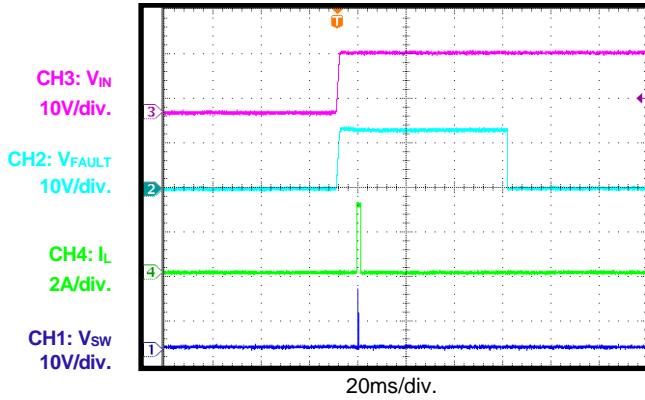

PWM Dimming

LED+ short to LED- entry

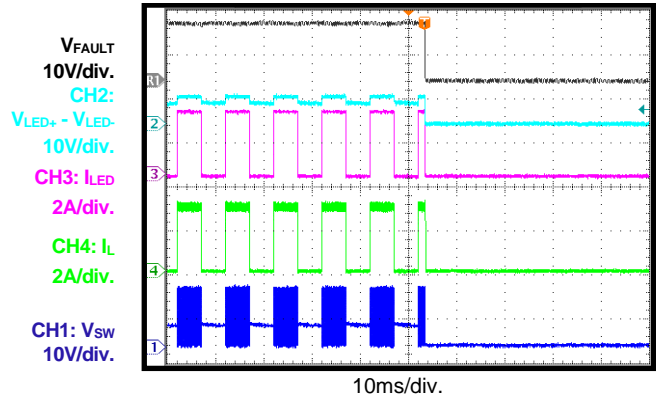

Two-Step Dimming

LED+ short to LED- start-up

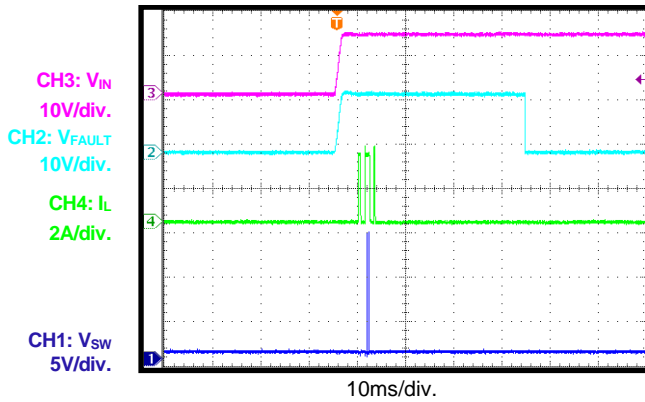

Two-Step Dimming

LED+ short to LED- entry

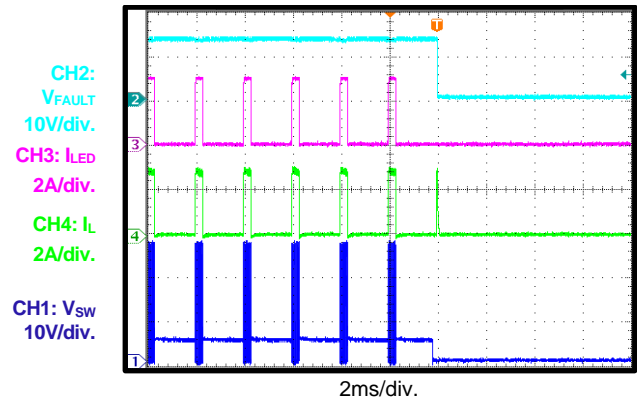

IREF Short Fault before IC Starts Up

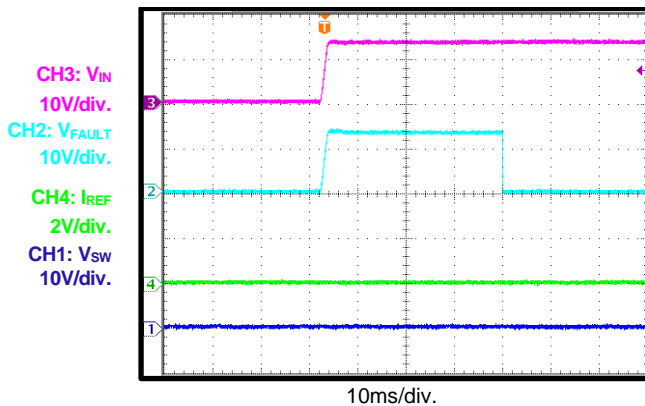

IREF Open Fault before IC Starts Up

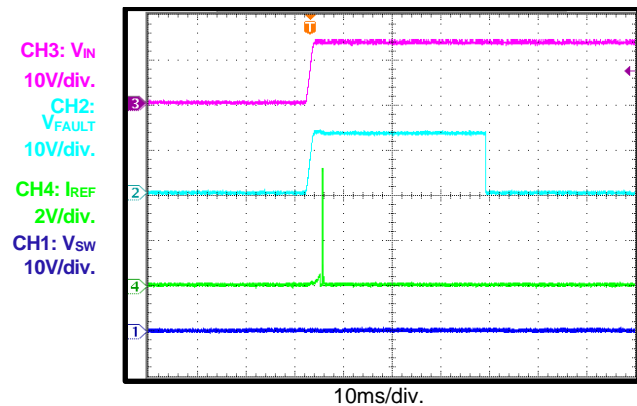

TYPICAL PERFORMANCE CHARACTERISTICS *(continued)*

Buck mode, 2 LEDs ($V_{LED} = 6V$), $V_{IN} = 13.5V$, $f_{SW} = 2.3MHz$, $L = 4.7\mu H$, $T_A = 25^\circ C$, unless otherwise noted.

IREF Short Fault after IC Starts Up

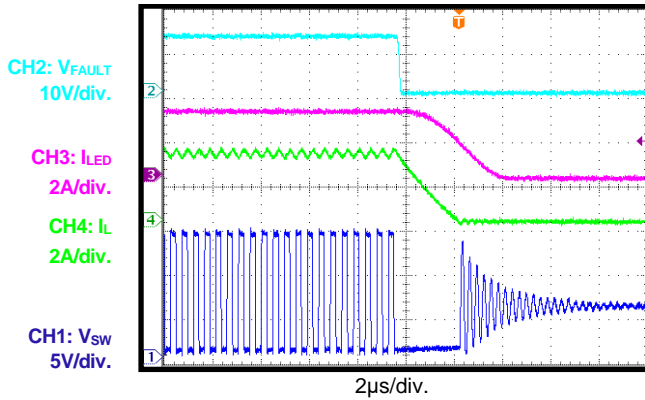

IREF Open Fault after IC Starts Up

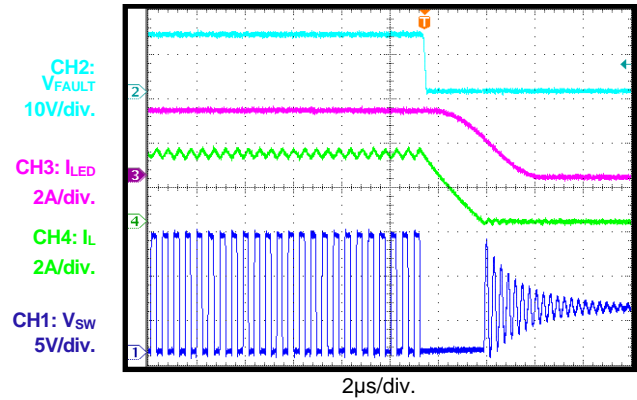

**IREF Short Fault after IC Starts Up
PWM dimming**

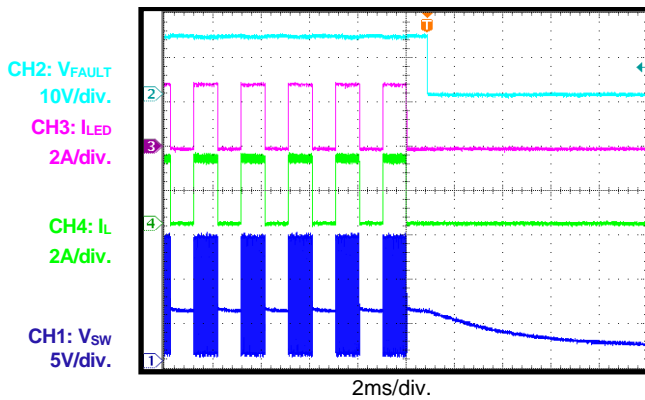

**IREF Open Fault after IC Starts Up
PWM dimming**

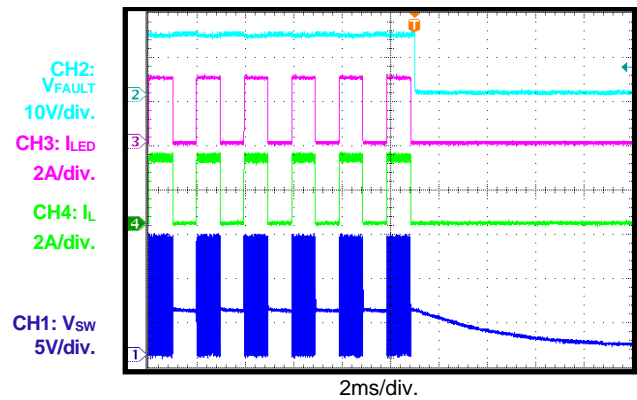

**ISET Short Fault before IC Starts Up
PWM dimming**

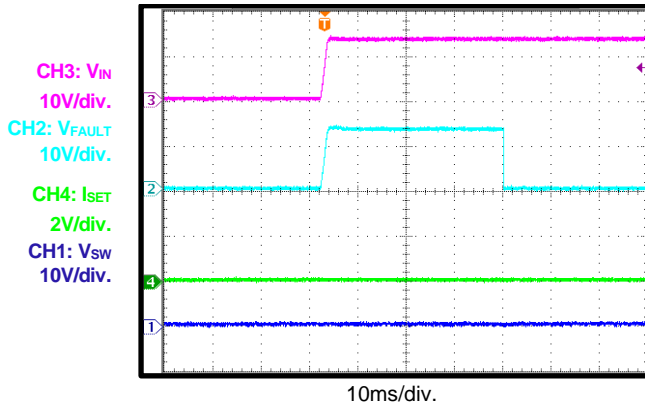

**ISET Open Fault before IC Starts Up
PWM dimming**

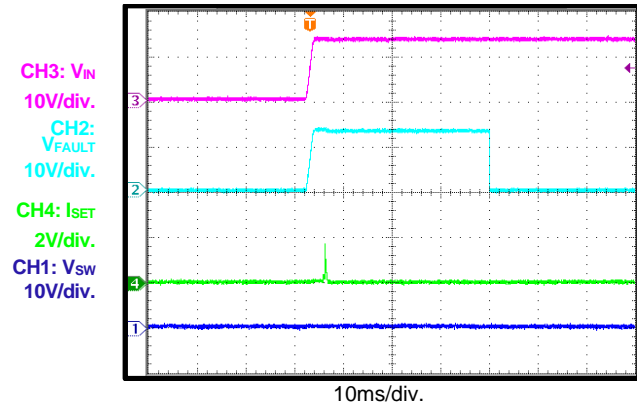

TYPICAL PERFORMANCE CHARACTERISTICS *(continued)*

Buck mode, 2 LEDs ($V_{LED} = 6V$), $V_{IN} = 13.5V$, $f_{SW} = 2.3MHz$, $L = 4.7\mu H$, $T_A = 25^\circ C$, unless otherwise noted.

ISET Short Fault after IC Starts Up

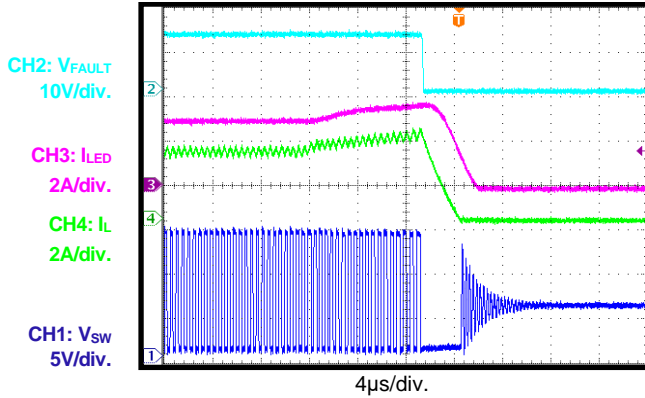

ISET Open Fault after IC Starts Up

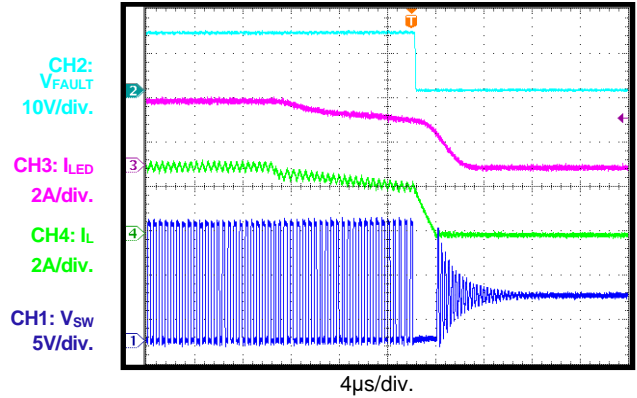

ISET Short Fault after IC Starts Up

PWM dimming

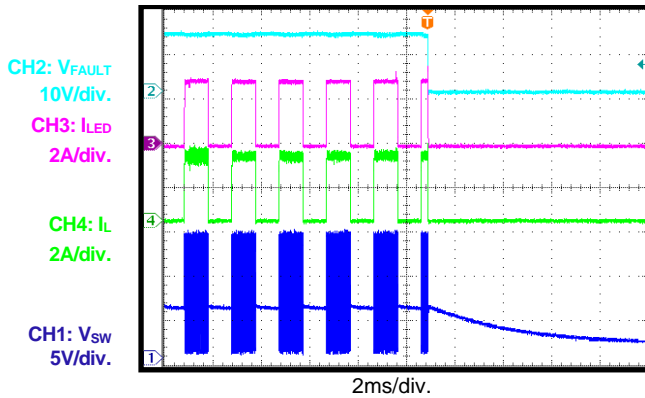

ISET Open Fault after IC Starts Up

PWM dimming

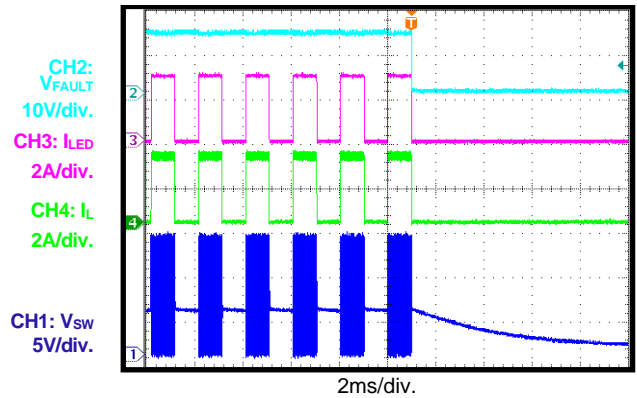

DUTY Short Fault before IC Starts Up

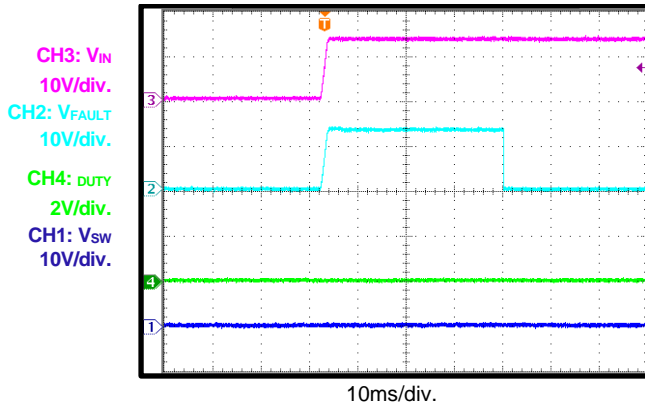

DUTY Open Fault before IC Starts Up

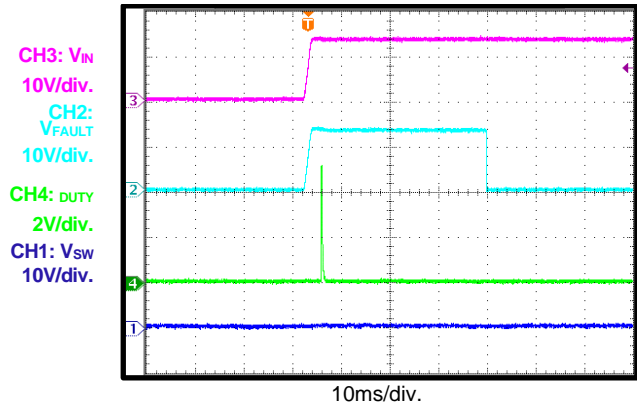

TYPICAL PERFORMANCE CHARACTERISTICS *(continued)*

Buck mode, 2 LEDs ($V_{LED} = 6V$), $V_{IN} = 13.5V$, $f_{SW} = 2.3MHz$, $L = 4.7\mu H$, $T_A = 25^\circ C$, unless otherwise noted.

Incorrect Mode Detection during VIN Start-Up

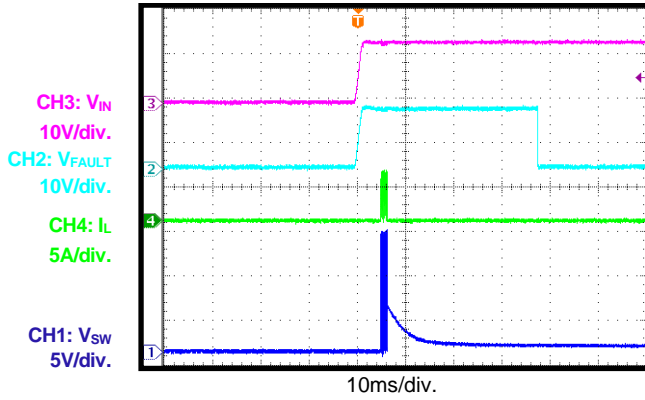

TYPICAL PERFORMANCE CHARACTERISTICS *(continued)*

Buck-boost mode, 4 LEDs ($V_{LED} = 12V$), $V_{IN} = 13.5V$, $f_{SW} = 1.15MHz$, $L = 4.7\mu H$, $T_A = 25^\circ C$, unless otherwise noted.

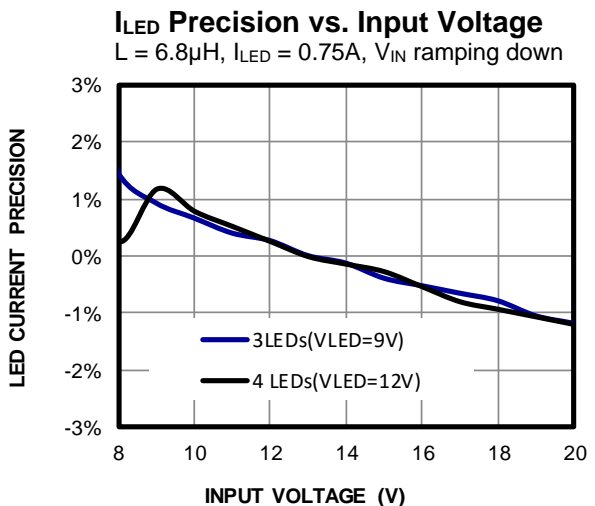
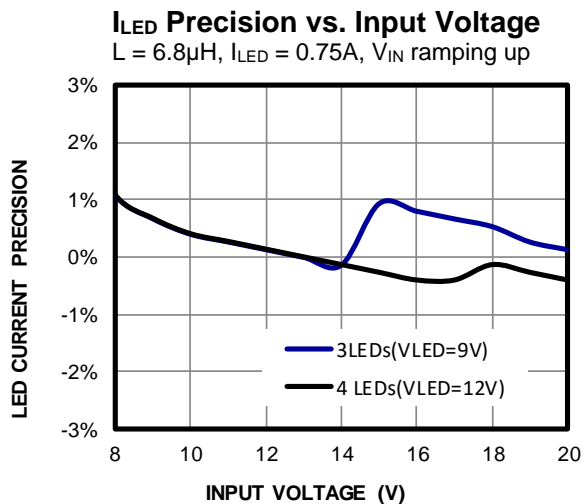
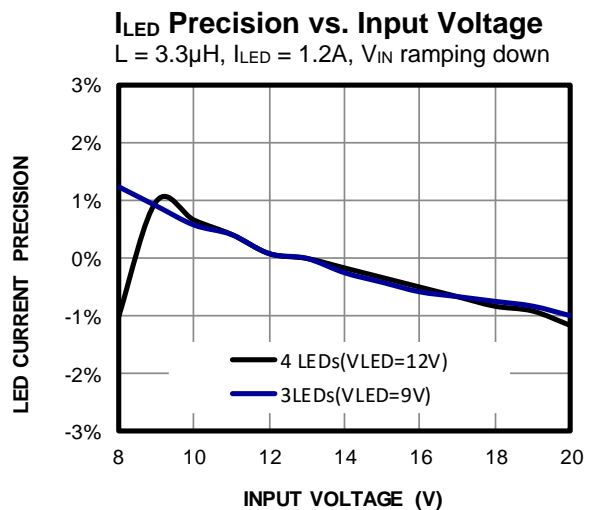
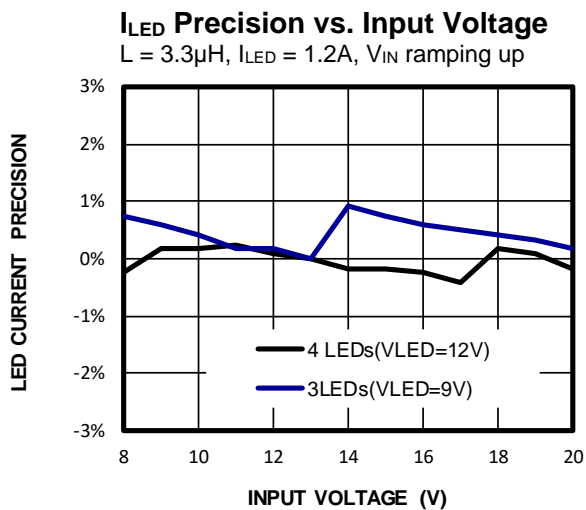
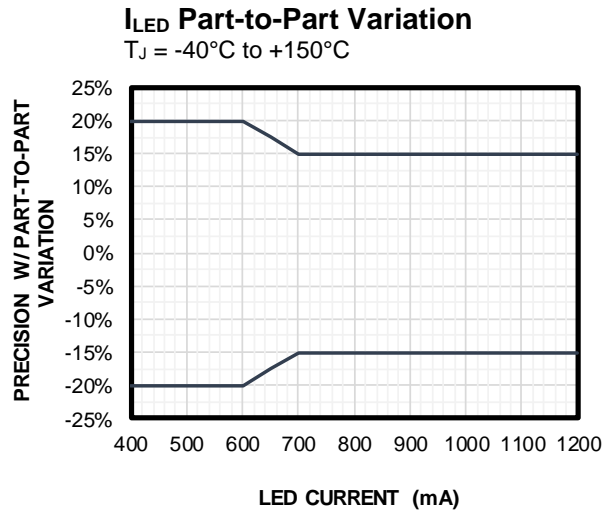
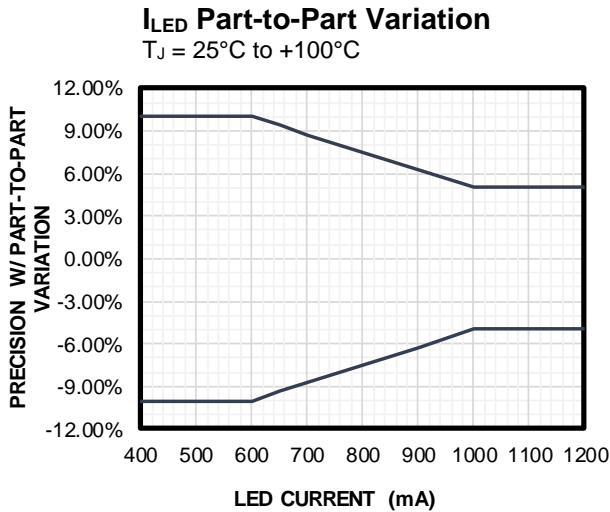

TYPICAL PERFORMANCE CHARACTERISTICS *(continued)*

Buck-boost mode, 4 LEDs ($V_{LED} = 12V$), $V_{IN} = 13.5V$, $f_{SW} = 1.15MHz$, $L = 4.7\mu H$, $T_A = 25^\circ C$, unless otherwise noted.

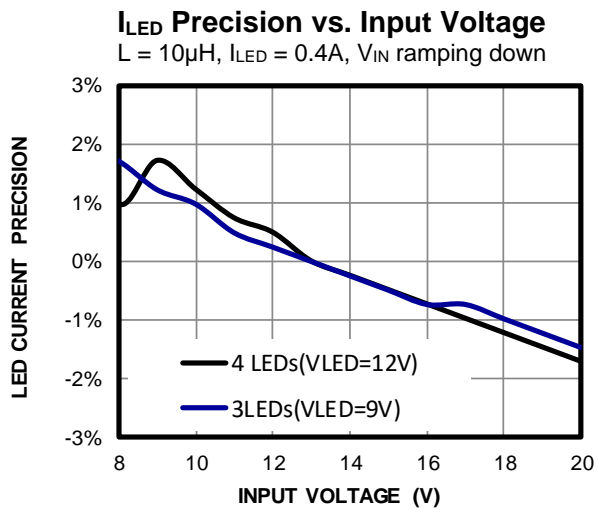
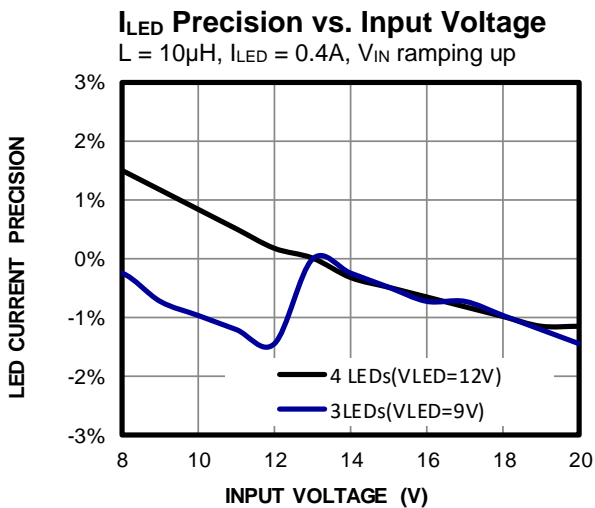
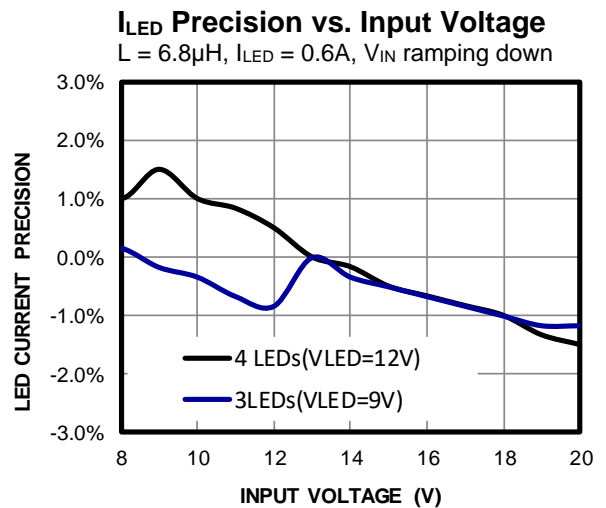
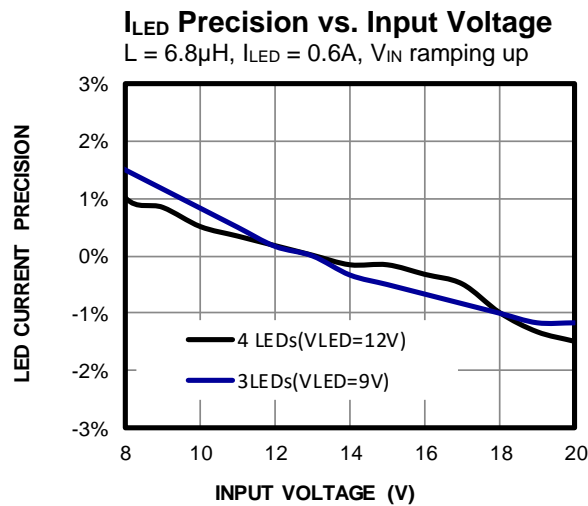
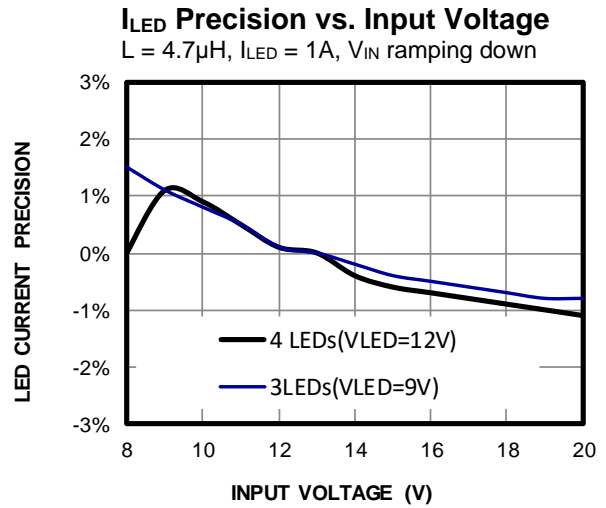
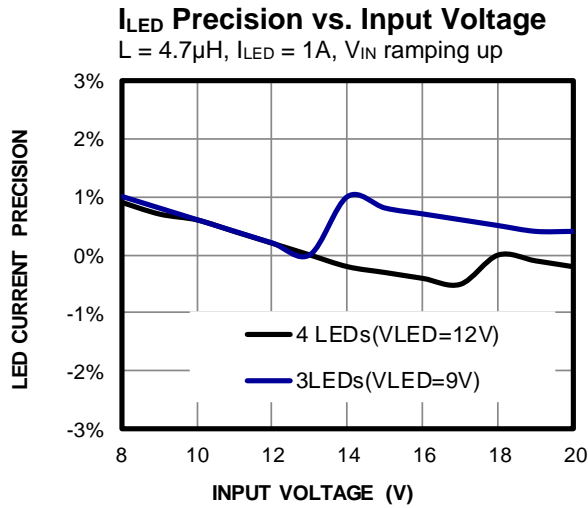

TYPICAL PERFORMANCE CHARACTERISTICS *(continued)*

Buck-boost mode, 4 LEDs ($V_{LED} = 12V$), $V_{IN} = 13.5V$, $f_{SW} = 1.15MHz$, $L = 4.7\mu H$, $T_A = 25^\circ C$, unless otherwise noted.

I_{LED} Precision vs. Inductor Value Variation

$V_{IN} = 13.5V$, 4 LEDs ($V_{LED} = 12V$)

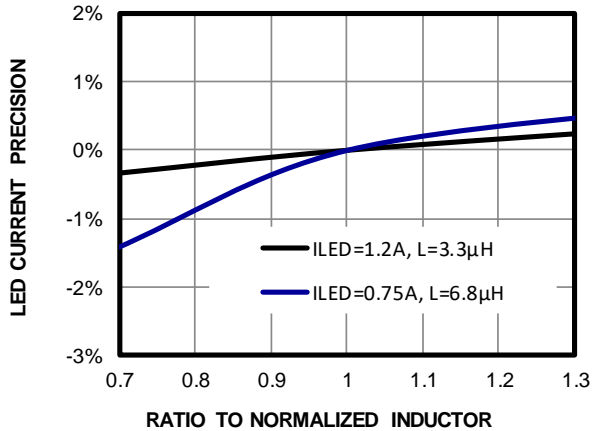

I_{LED} Precision vs. Inductor Value Variation

$V_{IN} = 13.5V$, 3 LEDs ($V_{LED} = 9V$)

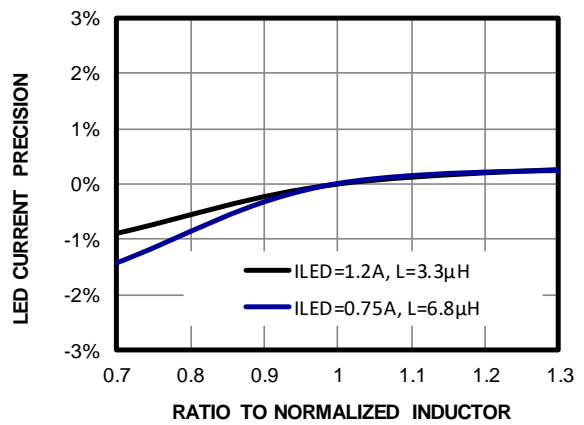

I_{LED} Precision vs. HS-FET Temperature Sense

4 LEDs ($V_{LED} = 12V$)

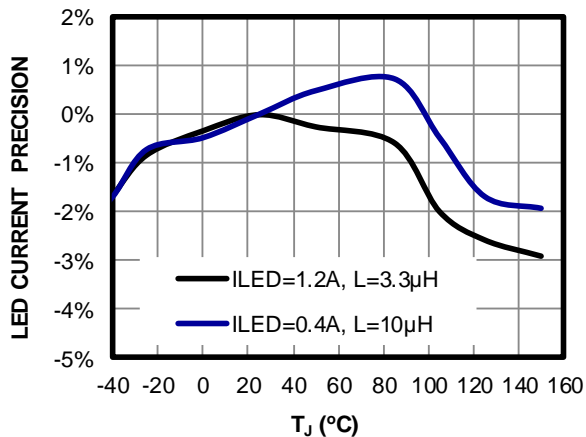

I_{LED} Precision vs. LS-FET Temperature Sense

4 LEDs ($V_{LED} = 12V$)

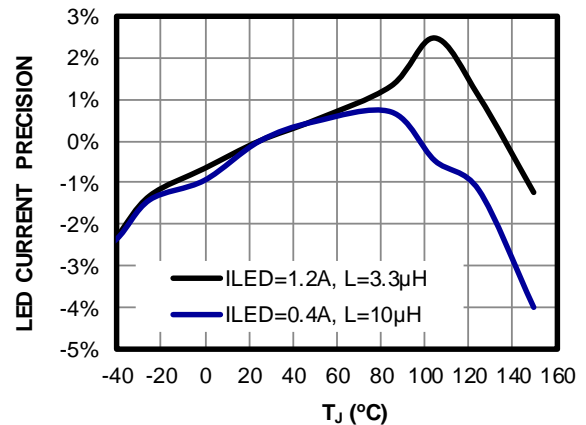

V_{IN} Slow Ramp Up and Down

4 LEDs ($V_{LED} = 12V$), $I_{LED} = 1.2A$,
 $V_{IN} = 0V$ to $20V$, $0.001V/ms$

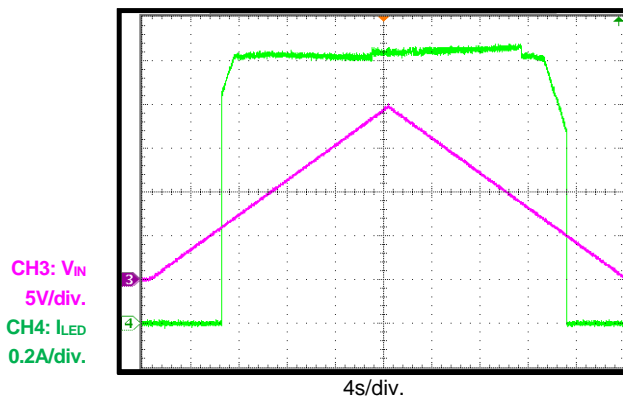

V_{IN} Slow Ramp Up and Down

3 LEDs ($V_{LED} = 9V$), $I_{LED} = 1.2A$,
 $V_{IN} = 0V$ to $20V$, $0.001V/ms$

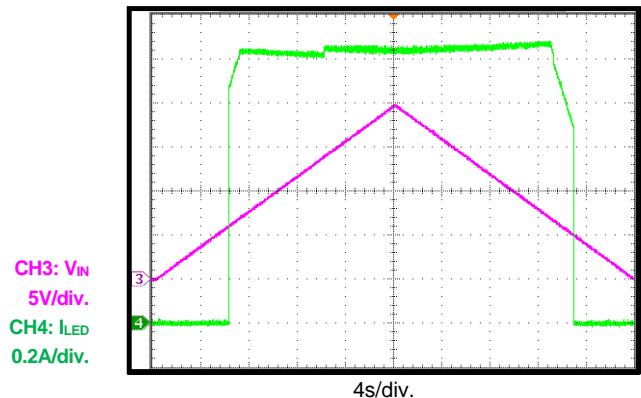

TYPICAL PERFORMANCE CHARACTERISTICS(continued)

Buck-boost mode, $V_{IN} = 12V$, 4 LEDs in series ($V_{LED} = 12V$), $I_{LED} = 1.2A$, $L = 4.7\mu H$, $f_{SW} = 1.15MHz$, with EMI filters, $T_A = 25^\circ C$, unless otherwise noted. (7)

CISPR25 Class 5 Peak Conducted Emissions

150kHz to 108MHz

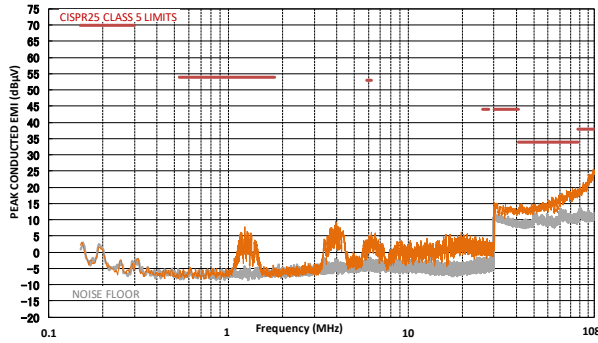

CISPR25 Class 5 Average Conducted Emissions

150kHz to 108MHz

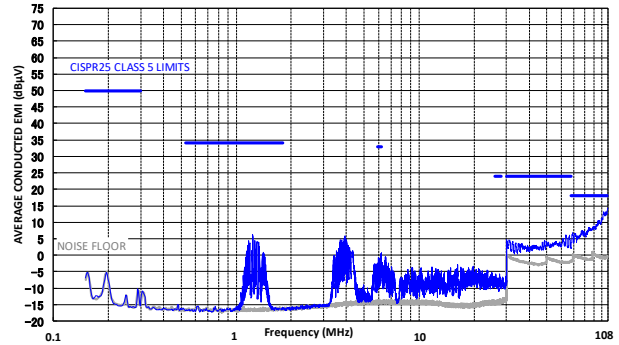

CISPR25 Class 5 Peak Radiated Emissions

150kHz to 30MHz

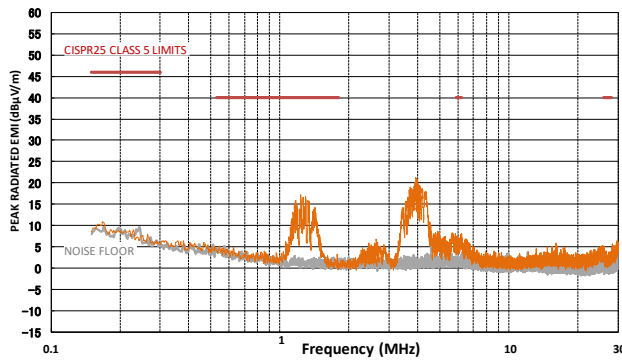

CISPR25 Class 5 Average Radiated Emissions

150kHz to 30MHz

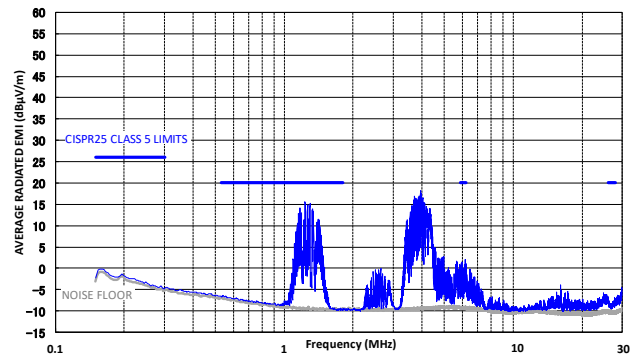

CISPR25 Class 5 Peak Radiated Emissions

Horizontal, 30MHz to 200MHz

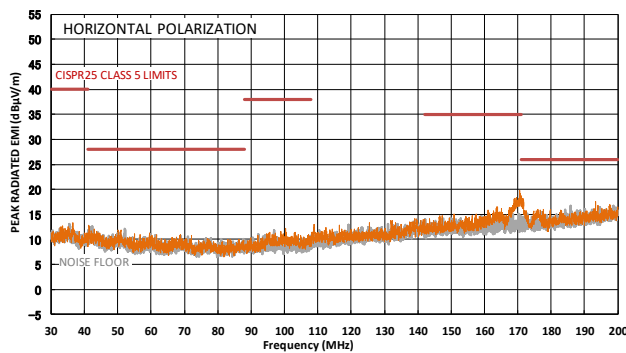

CISPR25 Class 5 Average Radiated Emissions

Horizontal, 30MHz to 200MHz

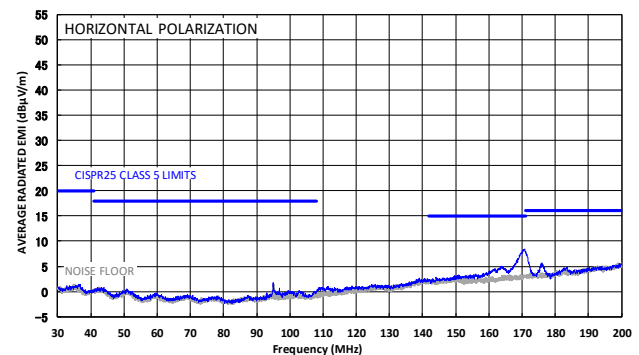

TYPICAL PERFORMANCE CHARACTERISTICS *(continued)*

Buck-boost mode, $V_{IN} = 12V$, 4 LEDs in series ($V_{LED} = 12V$), $I_{LED} = 1.2A$, $L = 4.7\mu H$, $f_{SW} = 1.15MHz$, with EMI filters, $T_A = 25^\circ C$, unless otherwise noted. (7)

CISPR25 Class 5 Peak Radiated Emissions

Vertical, 30MHz to 200MHz

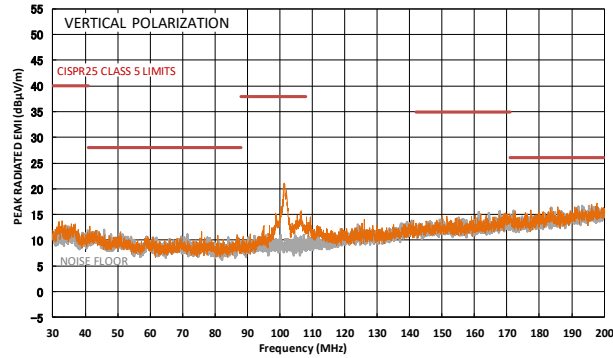

CISPR25 Class 5 Average Radiated Emissions

Vertical, 30MHz to 200MHz

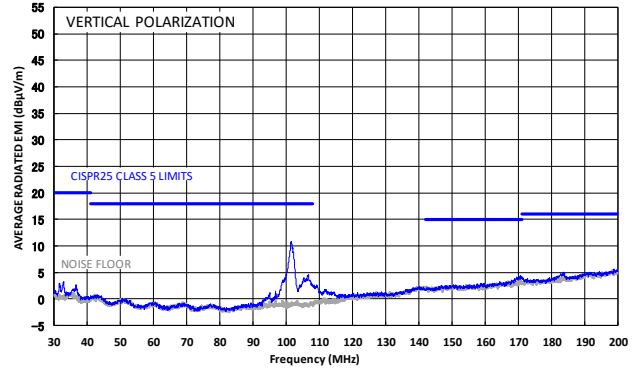

CISPR25 Class 5 Peak Radiated Emissions

Horizontal, 200MHz to 1GHz

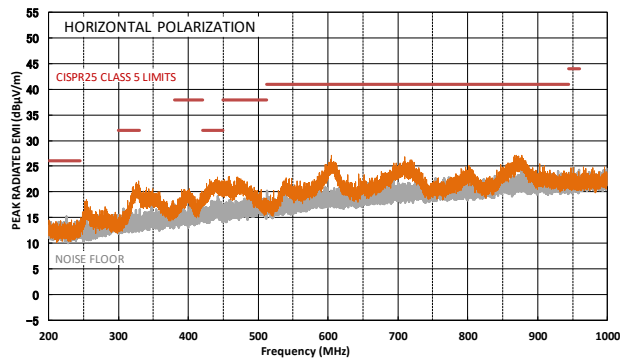

CISPR25 Class 5 Average Radiated Emissions

Horizontal, 200MHz to 1GHz

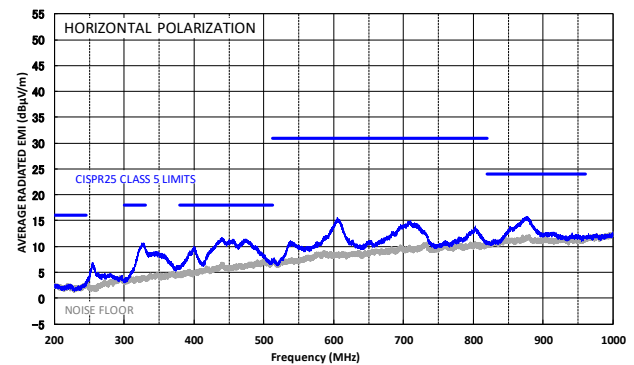

CISPR25 Class 5 Peak Radiated Emissions

Vertical, 200MHz to 1GHz

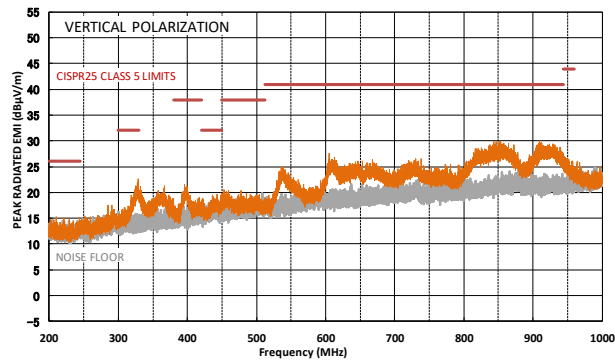

CISPR25 Class 5 Average Radiated Emissions

Vertical, 200MHz to 1GHz

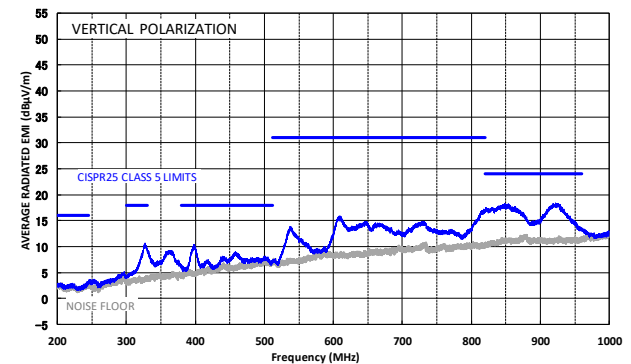

Notes:

7) The MPQ7200 buck-boost mode EMC test results are based on the application circuit with EMI filters in Figure 11 on page 54.

TYPICAL PERFORMANCE CHARACTERISTICS (continued)

Buck-boost mode, 4 LEDs ($V_{LED} = 12V$), $V_{IN} = 13.5V$, $f_{SW} = 1.15MHz$, $L = 4.7\mu H$, $T_A = 25^\circ C$, unless otherwise noted.

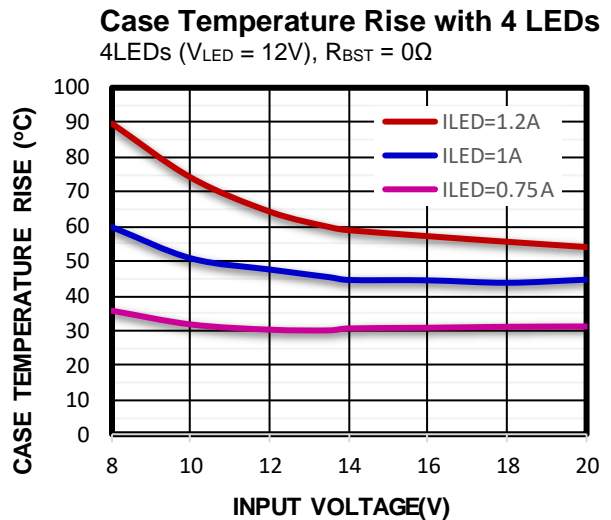
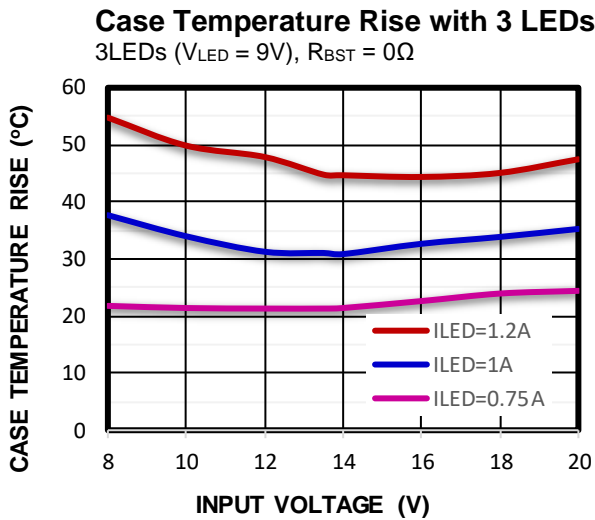
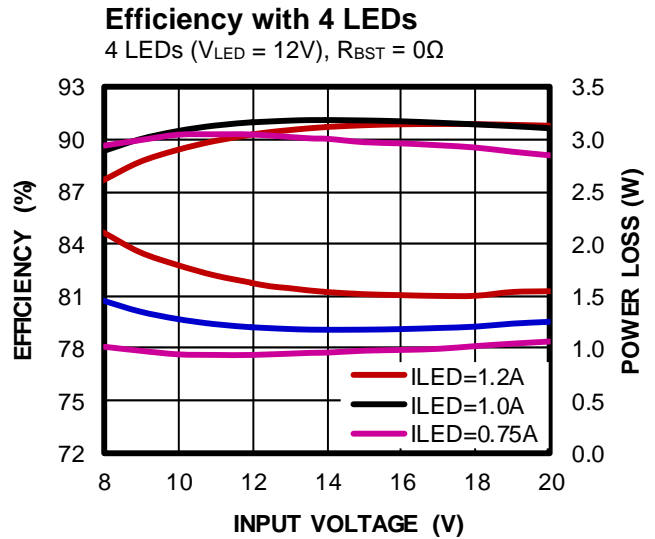
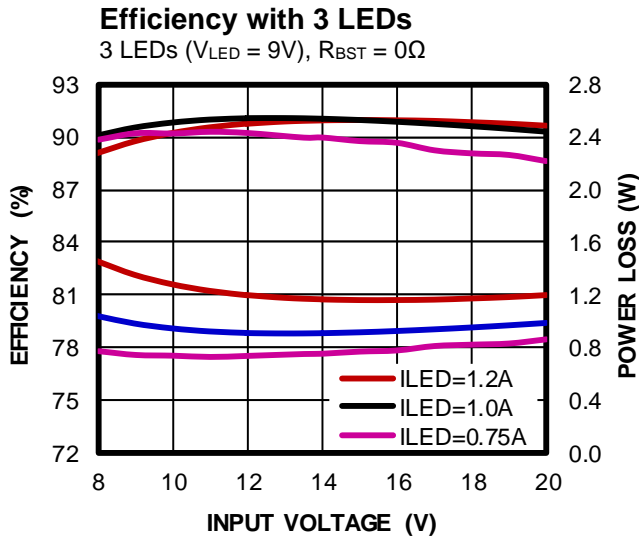

Steady State

$I_{LED} = 1.2A$

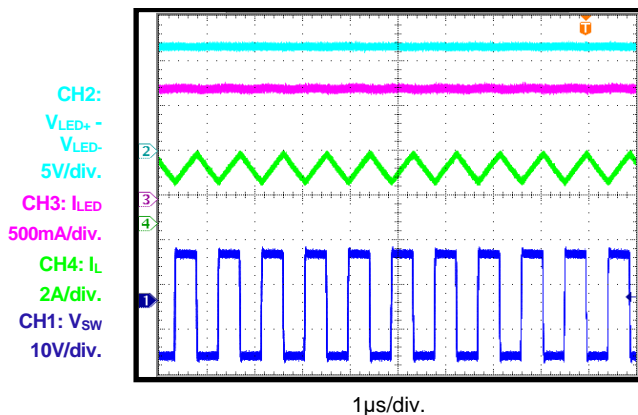

Start-Up through VIN

$I_{LED} = 1.2A$

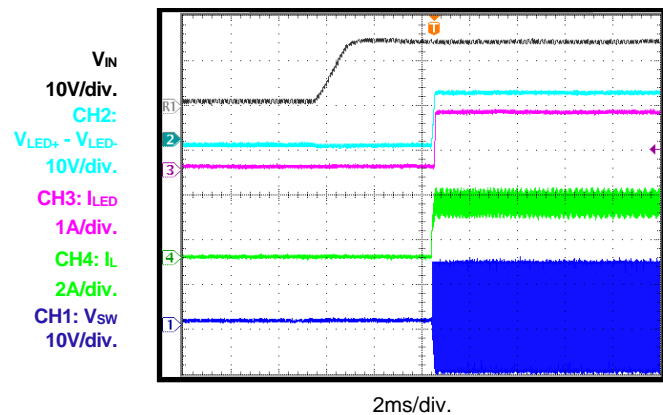

TYPICAL PERFORMANCE CHARACTERISTICS (continued)

Buck-boost mode, 4 LEDs ($V_{LED} = 12V$), $V_{IN} = 13.5V$, $f_{SW} = 1.15MHz$, $L = 4.7\mu H$, $T_A = 25^\circ C$, unless otherwise noted.

Shutdown through VIN

$I_{LED} = 1.2A$

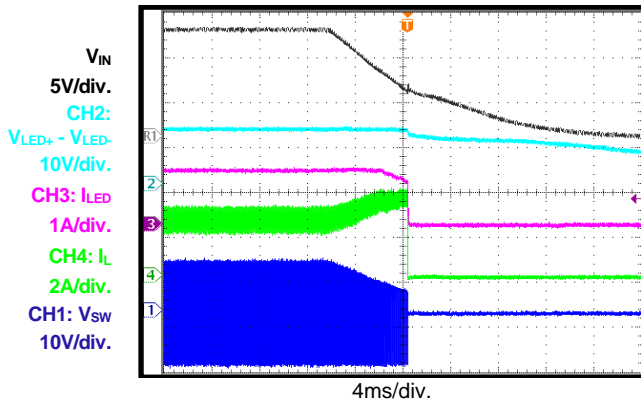

Start-Up through EN

$I_{LED} = 1.2A$

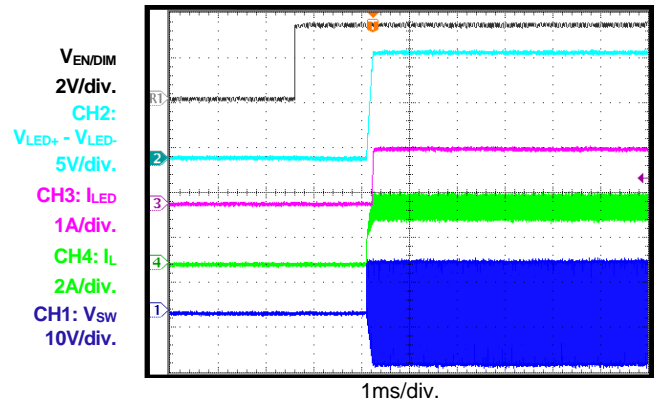

Shutdown through EN

$I_{LED} = 1.2A$

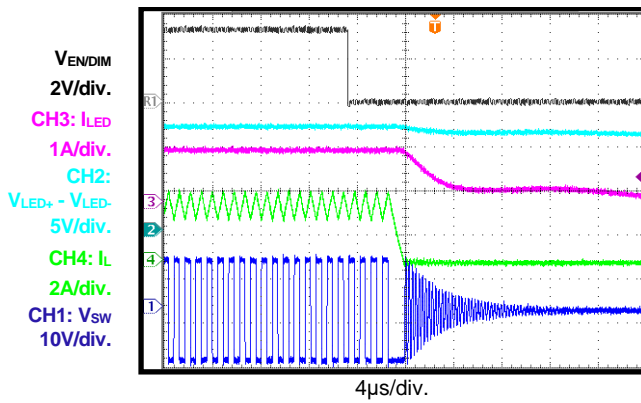

PWM Dimming in Steady State

Dimming frequency = 100Hz

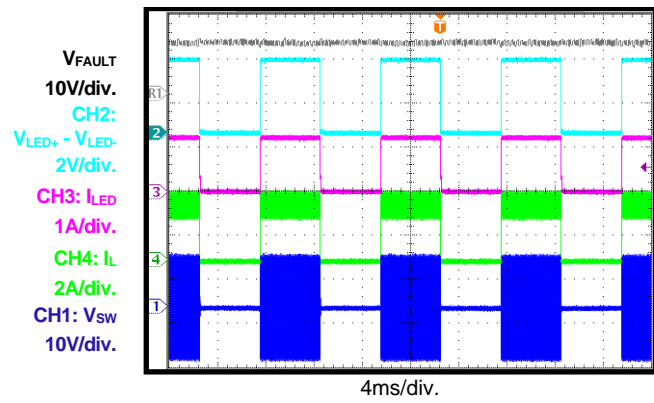

PWM Dimming in Steady State

Dimming frequency = 500Hz

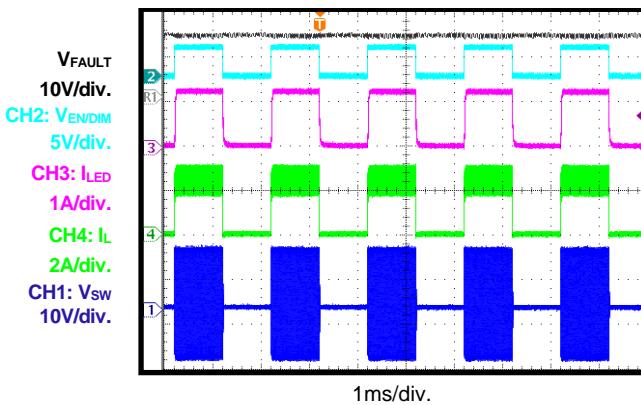

PWM Dimming

Start-up through VIN

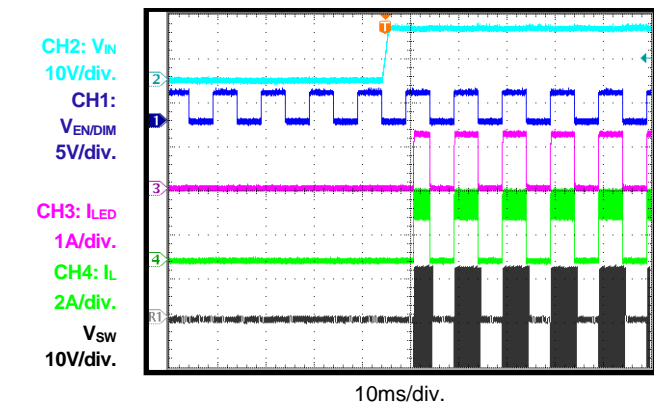

TYPICAL PERFORMANCE CHARACTERISTICS (continued)

Buck-boost mode, 4 LEDs ($V_{LED} = 12V$), $V_{IN} = 13.5V$, $f_{SW} = 1.15MHz$, $L = 4.7\mu H$, $T_A = 25^\circ C$, unless otherwise noted.

PWM Dimming
Shutdown through VIN

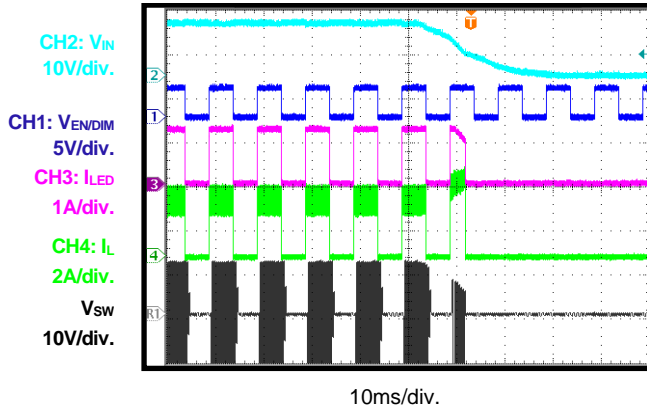

Two-Step Dimming
Steady state

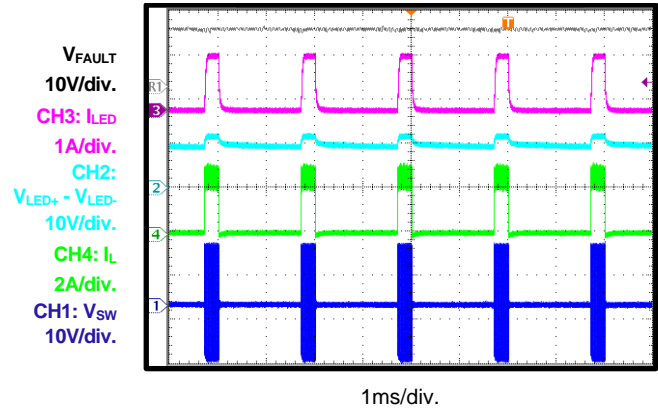

Two-Step Dimming
Start-up through VIN

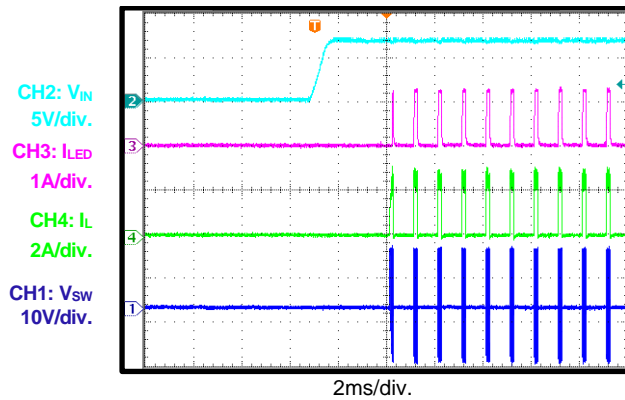

Two-Step Dimming
Shutdown through VIN

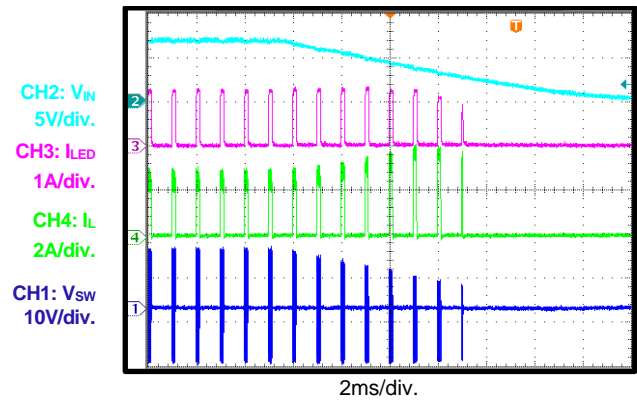

No Dimming
LED open VIN start-up

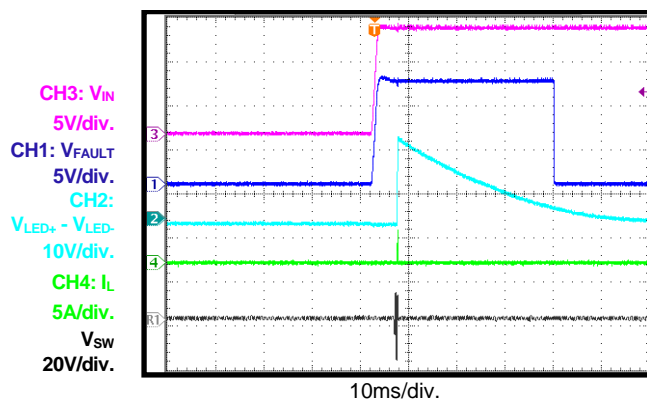

No Dimming
LED open entry

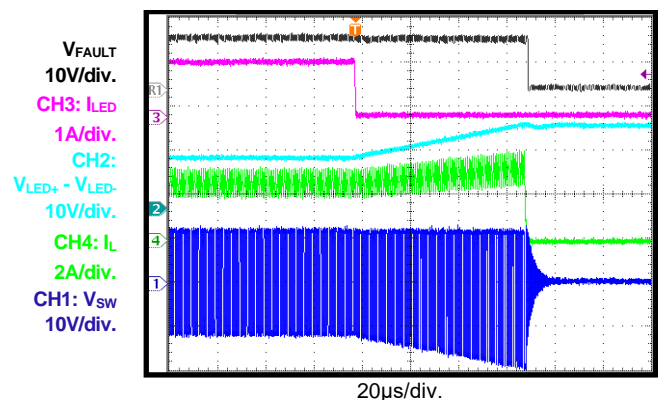

TYPICAL PERFORMANCE CHARACTERISTICS *(continued)*

Buck-boost mode, 4 LEDs ($V_{LED} = 12V$), $V_{IN} = 13.5V$, $f_{SW} = 1.15MHz$, $L = 4.7\mu H$, $T_A = 25^\circ C$, unless otherwise noted.

PWM Dimming

LED open VIN start-up

CH3: V_{IN}
10V/div.
CH1: V_{FAULT}
10V/div.
CH2: $V_{LED+} - V_{LED-}$
10V/div.
CH4: I_L
2A/div.
 V_{sw}
20V/div.

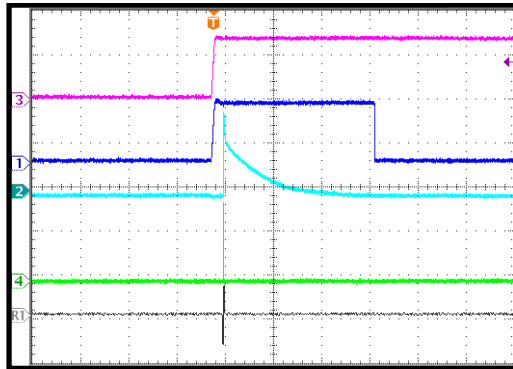

PWM Dimming

LED open entry

CH1: $V_{LED+} - V_{LED-}$
10V/div.
CH2: V_{FAULT}
10V/div.
CH3: I_{LED}
1A/div.
CH4: I_L
2A/div.
 V_{sw}
20V/div.

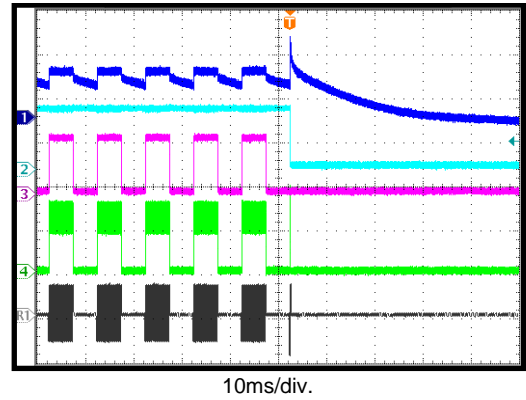

Two-Step Dimming

LED open VIN start-up

CH3: V_{IN}
10V/div.
CH1: V_{FAULT}
10V/div.
CH2: $V_{LED+} - V_{LED-}$
10V/div.
CH4: I_L
2A/div.
 V_{sw}
20V/div.

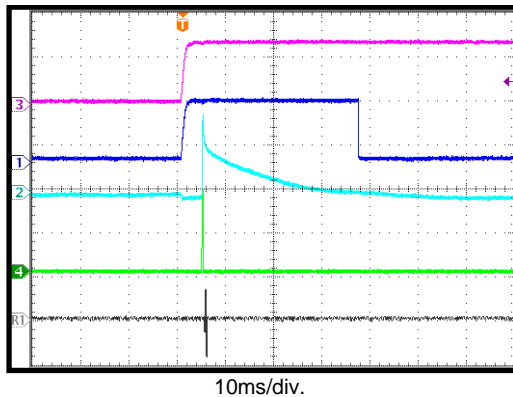

Two-Step Dimming

LED open entry

CH2: V_{FAULT}
10V/div.
CH3: I_{LED}
1A/div.
CH4: I_L
2A/div.
CH1: $V_{LED+} - V_{LED-}$
10V/div.

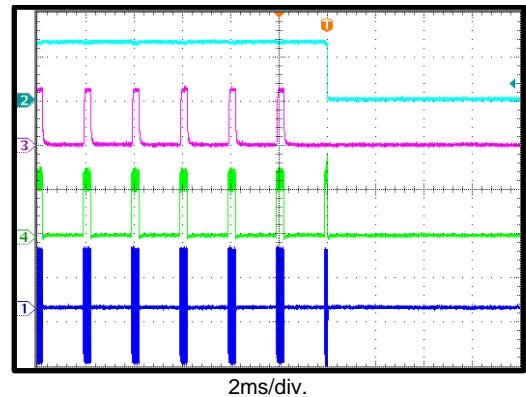

No Dimming

LED+ short to LED-, VIN start-up

CH3: V_{IN}
5V/div.
CH2: V_{FAULT}
5V/div.
CH4: I_L
1A/div.
CH1: V_{sw}
5V/div.

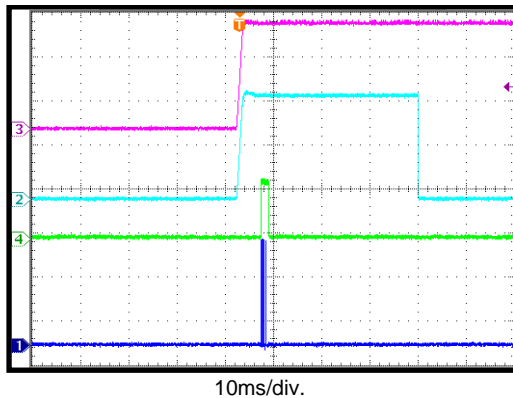

No Dimming

LED+ short to LED- entry

V_{FAULT}
10V/div.
CH2: $V_{LED+} - V_{LED-}$
10V/div.
CH3: I_{LED}
1A/div.
CH4: I_L
2A/div.
CH1: V_{sw}
10V/div.

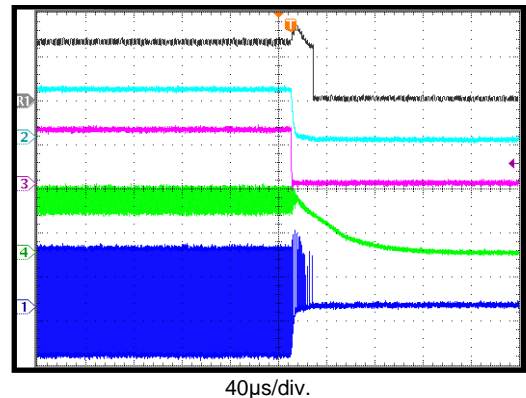

TYPICAL PERFORMANCE CHARACTERISTICS *(continued)*

Buck-boost mode, 4 LEDs ($V_{LED} = 12V$), $V_{IN} = 13.5V$, $f_{SW} = 1.15MHz$, $L = 4.7\mu H$, $T_A = 25^\circ C$, unless otherwise noted.

PWM Dimming

LED+ short to LED-, VIN start-up

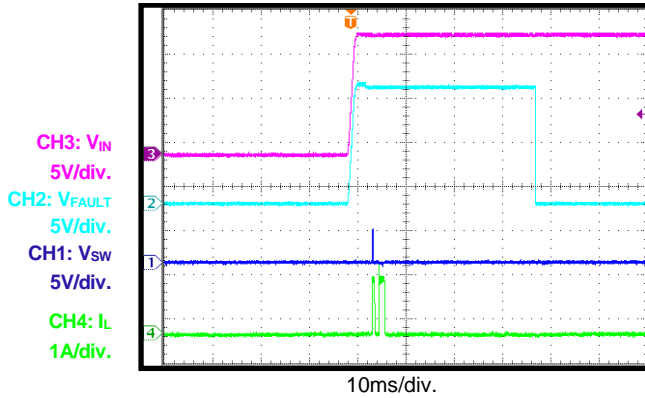

PWM Dimming

LED+ short to LED- entry

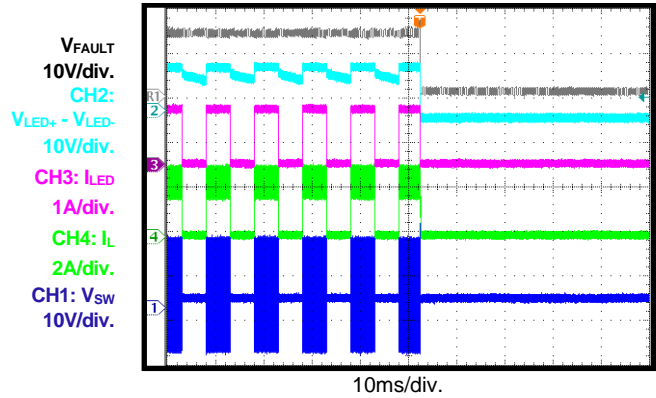

Two-Step Dimming

LED+ short to LED-, VIN start-up

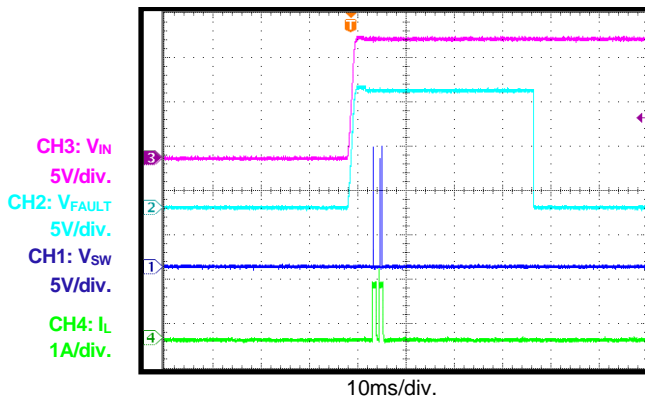

Two-Step Dimming

LED+ short to LED- entry

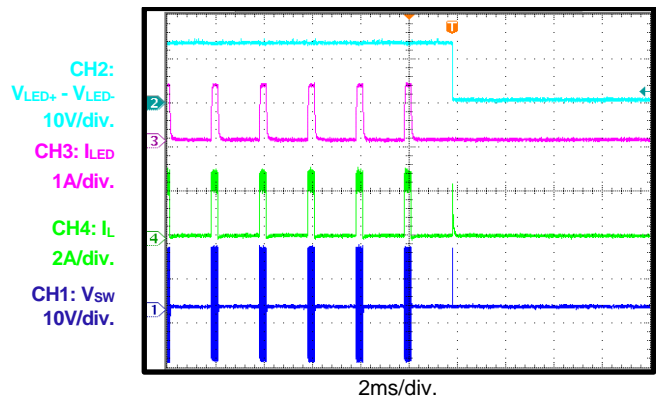

IREF Short Fault before VIN Start-Up

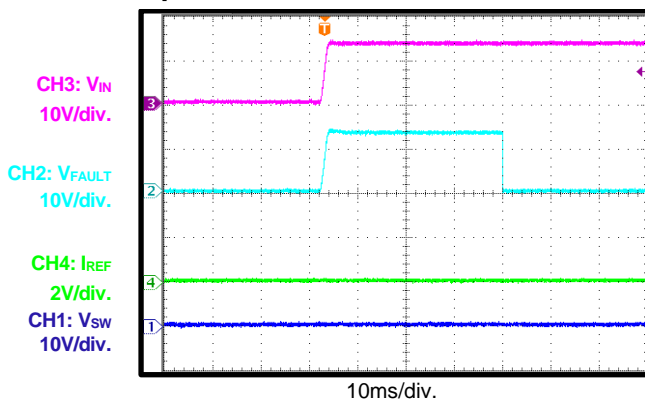

IREF Open Fault before VIN Start-Up

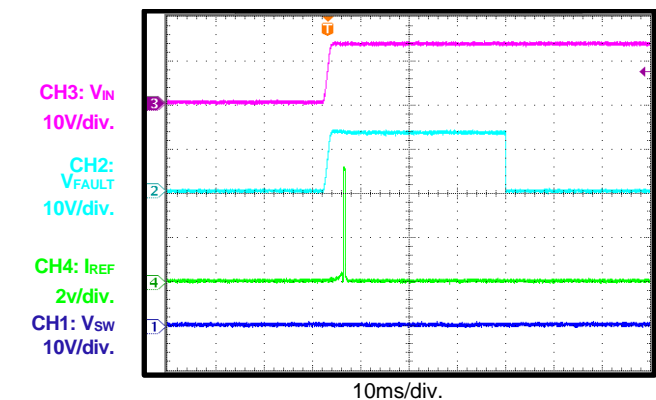

TYPICAL PERFORMANCE CHARACTERISTICS *(continued)*

Buck-boost mode, 4 LEDs ($V_{LED} = 12V$), $V_{IN} = 13.5V$, $f_{SW} = 1.15MHz$, $L = 4.7\mu H$, $T_A = 25^\circ C$, unless otherwise noted.

IREF Short Fault after VIN Start-Up

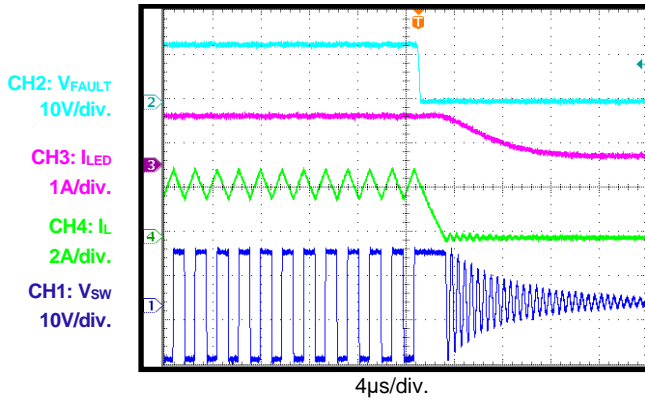

IREF Open Fault after VIN Start-Up

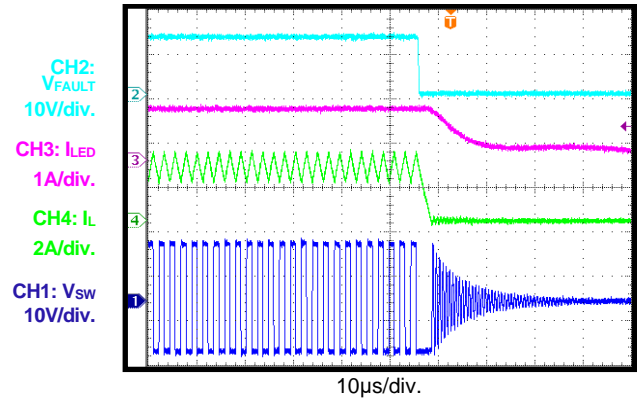

ISET Short Fault before VIN Start-Up

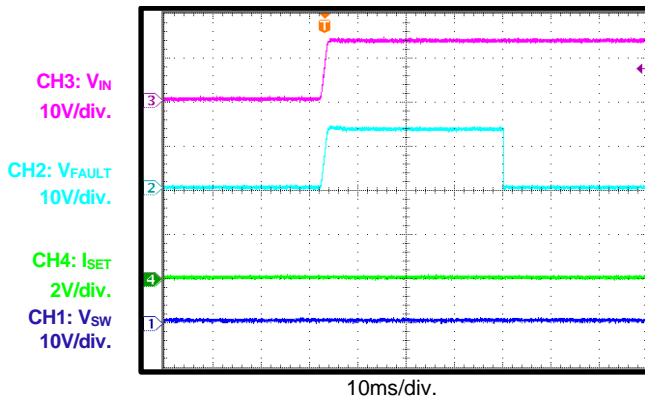

ISET Open Fault before VIN Start-Up

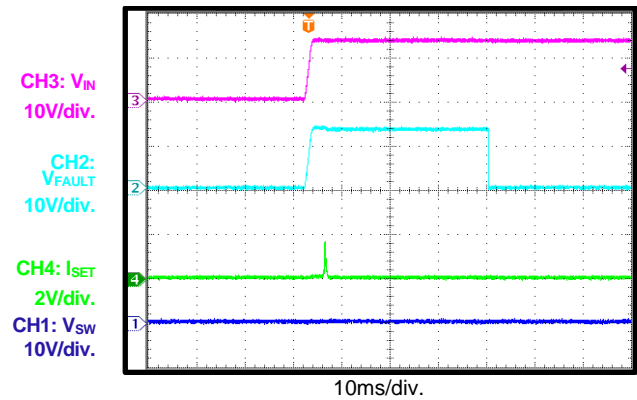

ISET Short Fault after VIN Start-Up

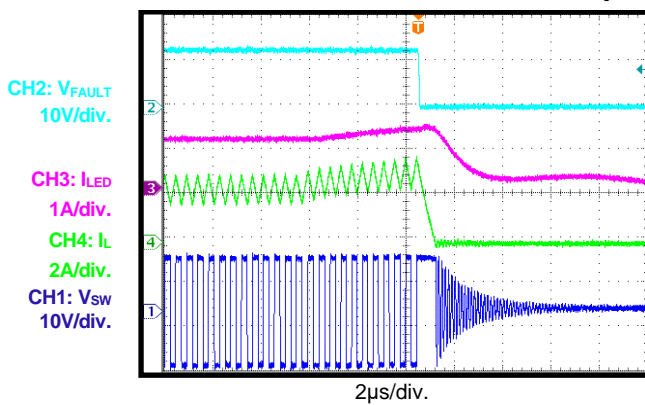

ISET Open Fault after VIN Start-Up

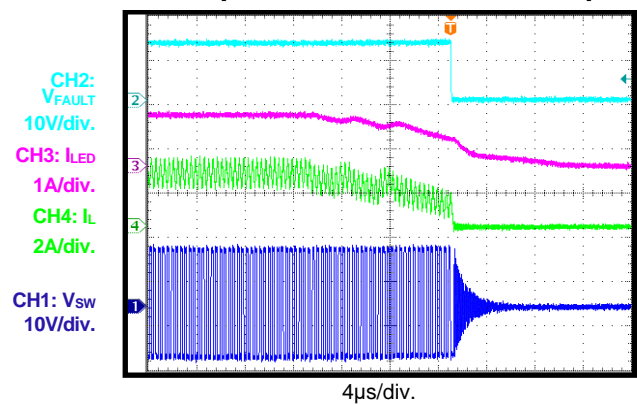

TYPICAL PERFORMANCE CHARACTERISTICS *(continued)*

Buck-boost mode, 4 LEDs ($V_{LED} = 12V$), $V_{IN} = 13.5V$, $f_{SW} = 1.15MHz$, $L = 4.7\mu H$, $T_A = 25^\circ C$, unless otherwise noted.

IDUTY Short Fault before VIN Start-Up

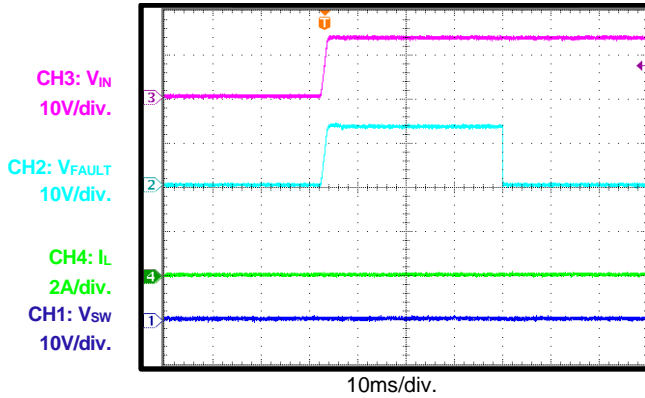

IDUTY Open Fault before VIN Start-Up

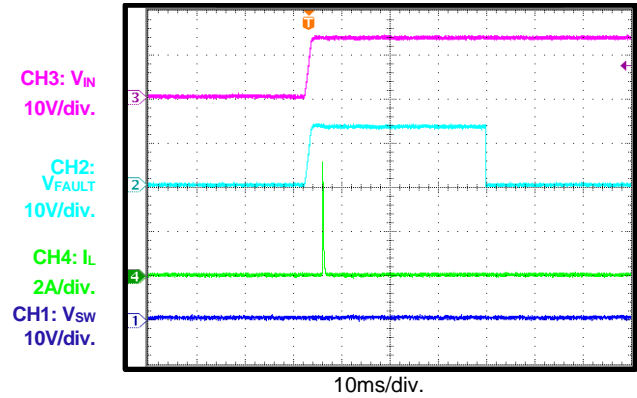

Wrong Mode Detection during VIN Start-Up

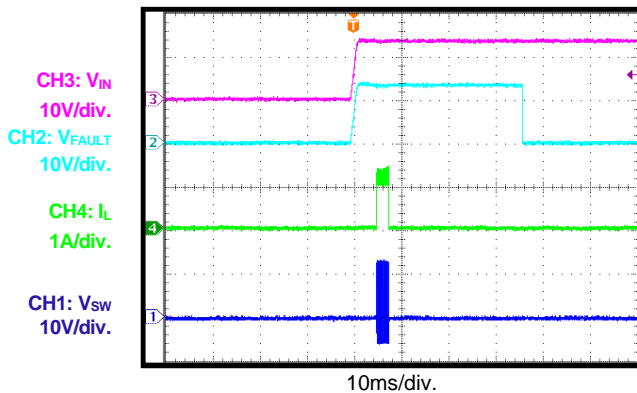

FUNCTIONAL BLOCK DIAGRAM

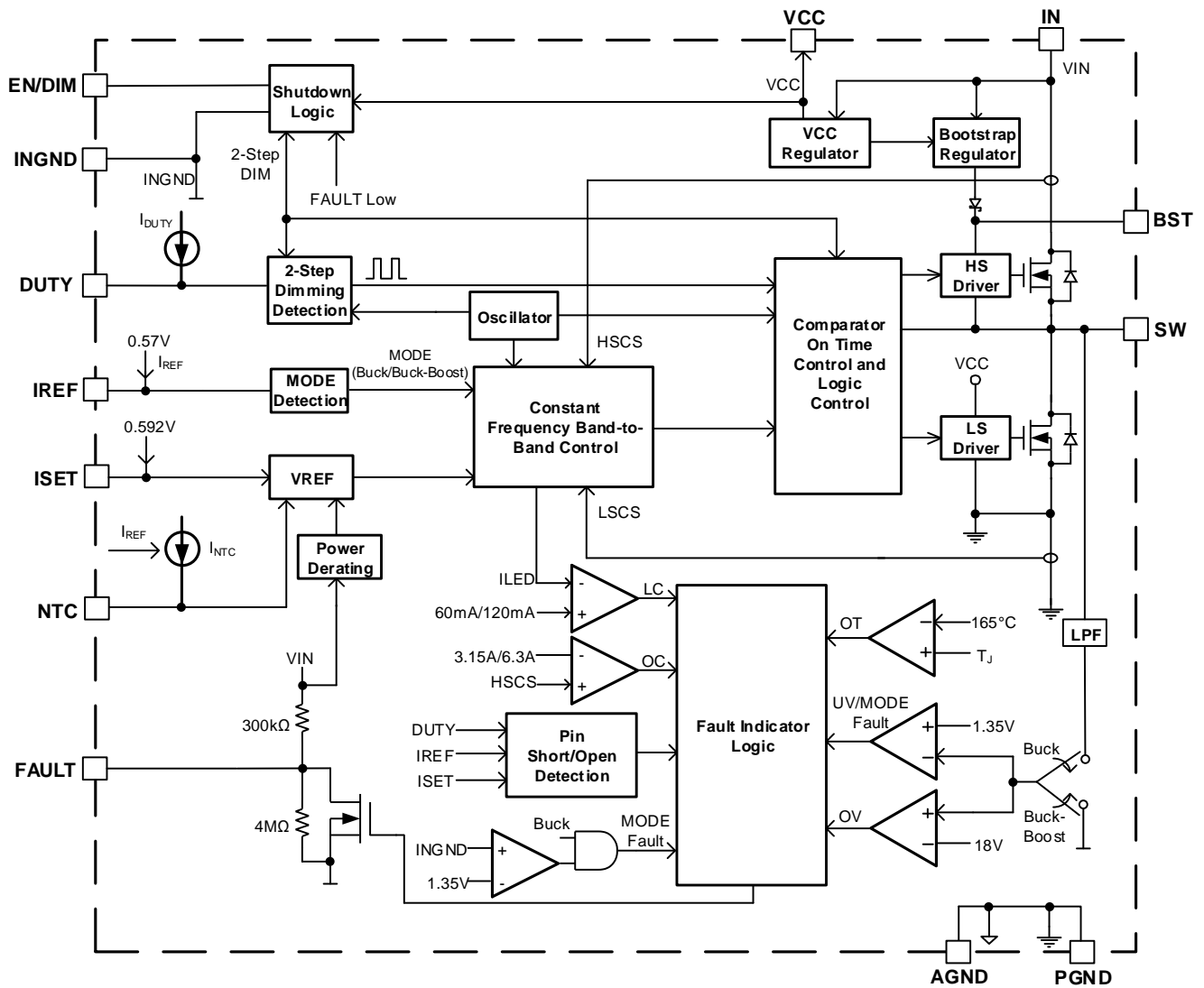

Figure 1: Functional Block Diagram

OPERATION

The MPQ7200 is a high-frequency, synchronous rectified, buck-boost or buck, switch-mode LED driver with built-in power MOSFETs. It offers a very compact solution to achieve up to 1.2A of continuous output current in buck-boost topologies and 3A in buck topologies, with excellent load and line regulation across a 6V to 42V input supply range.

Fixed-Frequency Band-to-Band Control

The MPQ7200 uses fixed-frequency band-band control and a spread spectrum technique to reduce EMC noise. Compared to fixed-frequency PWM control, band-to-band control offers the advantage of a simpler control loop and faster transient response. Even without an output capacitor, the loop is stable. Band-band control compares the inductor current to the internal thresholds (I_{BANDPEAK} and $I_{\text{BANDVALLEY}}$).

If the inductor current exceeds I_{BANDPEAK} , the high-side MOSFET (HS-FET) turns off. If the inductor current drops below $I_{\text{BANDVALLEY}}$, the HS-FET turns on. $(I_{\text{BANDPEAK}} + I_{\text{BANDVALLEY}}) / 2$ is controlled by a PID loop to regulate the LED current. $I_{\text{BANDPEAK}} - I_{\text{BANDVALLEY}}$ is controlled by a PLL loop to regulate the switching frequency to be 2.3MHz in buck mode or 1.15MHz in buck-boost mode. If the minimum on time ($t_{\text{ON_MIN}}$) or minimum off time ($t_{\text{OFF_MIN}}$) are triggered, the switching frequency is extended and the real switching frequency is $D / t_{\text{ON_MIN}}$, or $(1 - D) / t_{\text{OFF_MIN}}$, where D is the required duty cycle and $t_{\text{ON_MIN}}$ and $t_{\text{OFF_MIN}}$ are both 80ns maximum.

The additional spread spectrum uses a 15kHz modulation frequency with a triangular profile to spread the internal oscillator frequency over a $\pm 10\%$ nominal switching frequency window (1.15MHz in buck mode or 2.3MHz in buck-boost mode).

Middle-Point Inductor Current Sense

The MPQ7200 senses the LED current by sensing the middle point of the inductor current (I_{LMID}). I_{LMID} is sensed through the HS-FET or low-side MOSFET (LS-FET) depending on the duty cycle. I_{LMID} is sensed through the HS-FET when the duty cycle exceeds $D_{\text{TH_H}}$ (55% in buck mode or 60% in buck-boost mode), and is sensed through the LS-FET when the duty cycle is below $D_{\text{TH_L}}$ (45% in buck mode or 40% in buck-boost

mode). A duty cycle hysteresis ($D_{\text{TH_HYS}}$, 10% in buck mode or 20% in buck-boost mode) is used to frequently avoid the current-sense switches between the HS-FET and LS-FET at the critical duty cycle.

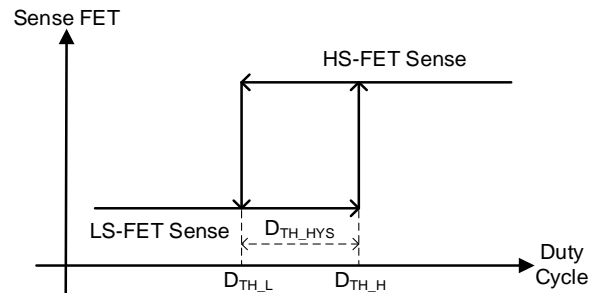

Figure 2: Current-Sense MOSFET vs. Duty Cycle

The LED current is equal to I_{LMID} in buck topologies, but is equal to $I_{\text{LMID}} \times V_{\text{IN}} / (V_{\text{IN}} + V_{\text{OUT}})$ in buck-boost topologies.

Buck and Buck-Boost Mode Selection

The MPQ7200 can be configured to a buck or buck-boost topology by connecting a different resistor at the IREF pin (R_{IREF}). The middle point of the inductor current (I_{LMID}) is sensed through a sensing FET. The LED current is equal to I_{LMID} in buck topologies, but is equal to $I_{\text{LMID}} \times V_{\text{IN}} / (V_{\text{IN}} + V_{\text{OUT}})$ in buck-boost topologies.

Mode detection starts when VCC reaches its under-voltage lockout (UVLO) threshold (4.7V). A 240 μ A current source ($I_{\text{REF_DET}}$) flows out of the IREF pin to detect the resistor voltage value on the pin when the device powers on. If the voltage generated by $I_{\text{REF_DET}} \times R_{\text{IREF}}$ is below 2.6V, buck-boost mode is selected. If $I_{\text{REF_DET}} \times R_{\text{IREF}}$ exceeds 2.8V, buck mode is selected. This means the corresponding R_{IREF} for buck-boost mode is $\leq 9.09\text{k}\Omega$ and $\geq 14.7\text{k}\Omega$ for buck mode. To avoid triggering a short on IREF in buck-boost mode, or an open fault on IREF in buck mode, the IREF resistor should be set between 1.05k Ω and 9.09k Ω for buck-boost mode, and between 14.7k Ω and 80.6k Ω for buck mode.

Once the detection finishes, the mode is latched and I_{REF} becomes $0.57\text{V} / R_{\text{IREF}}$, which is the reference for the NTC pin current. The latched mode signal is reset by the VCC under-voltage lockout (UVLO) threshold, but cannot be reset by EN/DIM going low. An internal 1MHz filter and 250 μ s deglitch time protect the part from false

mode detection caused by noise coupling at the pin. To ensure that the detected mode is consistent with the real topology connection, the INGND - PGND voltage is monitored. If INGND - PGND exceeds 1.35V in buck mode, or INGND - PGND is below 1.35V in buck-boost mode (detected as an output under-voltage condition), the part latches off and asserts FAULT.

Internal Regulator

The 5.1V internal regulator (VCC) powers most of the internal circuitries. VCC is ready once VIN reaches its rising UVLO threshold, regardless of whether EN is high or low. VCC is the reference for PGND and AGND, but not INGND. In buck-boost mode, VCC cannot have the same ground level as INGND. In buck-boost mode, the device takes either VIN or VINGND as the input. If $(V_{INGND} - V_{PGND}) < 5.1V$, VCC is powered from VIN. If $(V_{INGND} - V_{PGND}) > 5.1V$, the input of the VCC regulator switches to VINGND to reduce power loss.

Once the power of VCC switches to INGND, VIN will not power VCC until VINGND - VPGND drops below 4.8V. A small VCC capacitor causes VCC voltage ringing, and the switch may become unstable. To address this, a $\geq 3\mu F$ decoupling ceramic capacitor should be placed close to the VCC pin. When selecting a VCC capacitor, consider the capacitance derating to ensure that the real capacitance $\geq 3\mu F$. It is recommended to use a 10 μF X7R capacitor with $\geq 10V$ DC rated voltage. VCC has its own UVLO, with a 4.7V rising and 4.05V falling threshold. In addition to powering the internal circuitries, VCC can also power external circuitries in the system, with a current capability of 25mA.

Continuous Conduction Mode (CCM) and Discontinuous Conduction Mode (DCM)

The MPQ7200 uses continuous conduction mode (CCM) to ensure that the part works with fixed frequency from minimum loads to full loads. The advantage of CCM is its controllable frequency and lower output ripple at light-load. If $I_{BANDVALLEY} = 0A$, the MPQ7200 enters discontinuous current mode (DCM), the LS-FET acts as an ideal diode. Select an inductor that ensures that the part does not enter DCM, even during power or thermal derating. Otherwise, the LED current precision is not guaranteed.

Enable (EN) Control

When two-step dimming is not active (see the Two-Step Dimming section on page 43), EN/DIM is the control pin that turns the LED driver on and off. Drive $(V_{EN/DIM} - V_{INGND})$ above 2.5V to turn the device on; drive it below 1.58V for $>25ms$ to turn the device off and reset FAULT. The MPQ7200 starts thermal detection at the first positive edge of the EN/DIM signal, which causes an about 0.9ms delay between when EN/DIM turns on and when the device starts operating.

When two-step dimming is active, the MPQ7200 automatically turns on once VIN and VCC exceed their respective UVLO thresholds, and EN is configured to be the two-step dimming control pin. Driving EN/DIM high selects a 100% dimming duty, and driving it low selects an adjustable dimming duty set by the DUTY pin. EN cannot reset the FAULT pin in two-step dimming mode.

An internal 1M Ω resistor between the EN/DIM and INGND pins allows EN/DIM to be floated to shut down the chip. An integrated Zener diode is in parallel with the EN/DIM pin to clamp EN/DIM to about 7V (see Figure 3). EN/DIM can be connected to VIN using a pull-up resistor in both buck mode and buck-boost mode, or to VCC in buck mode for automatic start-up (once VIN and VCC exceed their respective UVLO thresholds). It is recommended to use a 100k Ω resistor to limit the EN/DIM input current to be below 1mA.

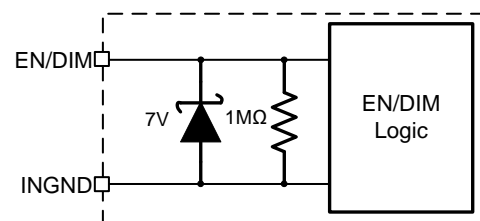

Figure 3: Internal EN/DIM Circuit

ISET

The average LED current can be configured by connecting a resistor (R_{ISET}) at the ISET pin. The LED current can be calculated with Equation (1):

$$I_{LED} (A) = 16 / R_{ISET} (k\Omega) \quad (1)$$

The nominal voltage of the ISET pin (V_{ISET}) is 0.592V. V_{ISET} can be set below 0.592V to decrease the LED current in the event of power derating or thermal derating.

During the mode detection period during start-up in buck mode, the ISET current is monitored to detect if the LED current is set above or below 600mA. If $I_{\text{ISET}} > 22.2\mu\text{A}$ during this period, the LED current setting is detected as $>600\text{mA}$, and the MOSFETs fully turn on. If the LED current setting is detected as $<600\text{mA}$, then half the MOSFETs are cut off to improve current-sense accuracy. When half the MOSFETs are cut off, the current limit drops from 6.3A to 3.15A. The signal to indicate if the LED current is above or below 600mA is latched once detection finishes, and only can be reset by VCC UVLO. After LED current detection, the MOSFET's $R_{\text{DS(ON)}}$ does not change, even if the current setting exceeds or falls below 600mA.

During normal operation, the ISET pin is continuously monitored to detect open or short-to-GND conditions. If the ISET current exceeds a specific value, a pin short to GND is detected. In buck-boost mode, the MOSFET is always on, regardless of the current.

If the LED current is set below 600mA, the ISET current threshold for short detection is $120\mu\text{A}$ (corresponding to a $4.9\text{k}\Omega$ resistor or $3.24\text{A } I_{\text{LED}}$). If the LED current is set above 600mA, the threshold is $220\mu\text{A}$ (corresponding to a $2.7\text{k}\Omega$ resistor or $5.9\text{A } I_{\text{LED}}$).

If the ISET current drops below $1.4\mu\text{A}$ (corresponding to $428\text{k}\Omega$ resistor or $37.3\text{mA } I_{\text{LED}}$), a pin open fault is detected.

The part latches off if an open or short fault is detected on the ISET pin, regardless of whether FAULT is asserted. FAULT is asserted if the ISET pin experiences a short or open fault after start-up. There is a 25ms-to-40ms delay for FAULT assertion during start-up.

IREF

The IREF pin configures the device for buck or buck-boost mode (see the Buck and Buck-Boost Mode Selection section on page 41), and afterward sets the current in the external NTC. After the mode is detected, the voltage of the IREF pin (V_{IREF}) is set to 0.57V with a 10.5% tolerance. Connect a resistor between IREF and AGND (R_{IREF}) to get a current (I_{REF}) equal to $0.57\text{V} / R_{\text{IREF}}$. This current is used as the reference current for the NTC's current source. The NTC current is 50 times that of I_{REF} in buck mode and 5 times that of I_{REF} in buck-boost mode.

The IREF pin is also continuously monitored to detect open and short-to-GND conditions.

If the IREF current exceeds $90\mu\text{A}$ in buck mode (corresponding to a $6.3\text{k}\Omega$ resistor) or $900\mu\text{A}$ in buck-boost mode (corresponding to a $0.63\text{k}\Omega$ resistor), the pin detects a short to GND. If the IREF current is below $3\mu\text{A}$ in buck mode (corresponding to a $190\text{k}\Omega$ resistor) or $40\mu\text{A}$ in buck-boost mode (corresponding to a $14.3\text{k}\Omega$ resistor), the pin detects an open fault.

If a fault is detected, the part latches off, regardless of whether the FAULT pin asserts. FAULT asserts low immediately if the pin experiences a short or an open fault after start-up. During start-up, there is a 25ms-to-40ms delay for FAULT assertion.

Pulse-Width Modulation (PWM) Dimming

When two-step dimming is disabled ($R_{\text{DUTY}} = 4.87\text{k}\Omega$), an external 100Hz to 2kHz PWM waveform can be applied to the EN/DIM pin for PWM dimming. In external PWM dimming mode, the part stops switching when EN/DIM drops below 1.58V and the LED current is 0A. The part resumes normal operation with a nominal LED current when EN/DIM exceeds 2.5V. The average LED current is proportional to the PWM duty, and its accuracy can be up to $\pm 15\%$ when $V_{\text{IN}} = 13.5\text{V} \pm 0.5\text{V}$ and T_{J} is between 25°C and 100°C .

The EN/DIM high voltage period should always be longer than $100\mu\text{s}$. Otherwise, the MPQ7200 may stop switching and not latch if an LED open fault is detected.

To avoid the part going into shutdown mode, the EN/DIM pin should not go low for longer than 10ms (the EN turn-off delay).

If a PWM signal is applied to EN/DIM once EN/DIM turns on, there is an about 0.9ms delay (due to thermal detection) before the MPQ7200 starts switching and the following the PWM dimming signal.

Two-Step Dimming

When VCC reaches its UVLO rising threshold (typically 4.7V), two-step dimming detection is activated on the DUTY pin. First, a $45\mu\text{A}$ current source (I_{DUTY1}) with a $\pm 11\%$ tolerance flows through the resistor between the DUTY pin and GND.

If the generated voltage (V_{DUTY}) exceeds 3.347V, an open fault is detected; then the part latches off and FAULT is asserted. If $0.302V < V_{DUTY} < 3.347V$, the two-step dimming functionality is activate. Table 1 shows the available two-step dimming duty cycles.

If V_{DUTY} is below 0.302V, DUTY’s current source increases to 600 μ A (I_{DUTY2}), with a $\pm 8.75\%$ If $0.302V < V_{DUTY} < 2.235V$, then two-step dimming is enabled, and the two-step dimming duty cycle is determined by the detailed V_{DUTY} . After duty detection finishes, the duty is not affected by changing V_{DUTY} , even if the DUTY pin experiences an open or short-to-GND fault.

Once two-step dimming is enabled, PWM dimming is disabled. Then the EN/DIM pin is used as the input pin to select no dimming or low dimming. When the EN/DIM pin is high, a 100% dimming duty cycle is selected; when EN/DIM is low, there is an adjustable dimming duty cycle determined by I_{DUTY} and V_{DUTY} (see Table 1). The device can switch between different dimming values in less than 20ms.

tolerance. This starts another round of V_{DUTY} detection. If $V_{DUTY} > 2.235V$ in this round, two-step dimming is disabled. Then the part can be turned on/off through EN/DIM, or can work in normal PWM dimming by applying a dimming signal at EN/DIM. If $V_{DUTY} < 0.302V$, a pin short fault is detected; then and the part latches off and FAULT asserts.

<100% dimming is implemented as PWM dimming, but not analog dimming. When two-step dimming is activated at I_{DUTY1} , the dimming duty can be set between 10% and 15%, with a 1% step. V_{DUTY} is between 0.302V and 3.347V, with a 33% reduction for each step. When two-step dimming is activated at I_{DUTY2} , the dimming duty can be set between 5% and 9%, with a 1% step. V_{DUTY} is between 0.302V and 2.235V, with a 33% reduction for each step. Table 1 shows the relationship between two-step dimming duty and the V_{DUTY} window while considering different V_{DUTY} tolerance thresholds.

Table 1: Two-Step Dimming Duty vs. V_{DUTY} Window

Two-Step Dimming Duty		Corresponding V_{DUTY} Window					
		V_{DUTY_H}			V_{DUTY_L}		
I_{DUTY1}	I_{DUTY2}	Min	Typ	Max	Min	Typ	Max
Latch	No two-step dimming	4.018	4.100	4.182	3.280	3.347	3.414
15%		3.280	3.347	3.414	2.190	2.235	2.279
14%	9%	2.190	2.235	2.279	1.460	1.489	1.519
13%	8%	1.460	1.489	1.519	0.969	0.989	1.009
12%	7%	0.969	0.989	1.009	0.634	0.653	0.673
11%	6%	0.634	0.653	0.673	0.407	0.428	0.449
10%	5%	0.407	0.428	0.449	0.28	0.302	0.33
To I_{DUTY2}	Latch	0.28	0.302	0.33	N/A		

Ensure that the V_{DUTY} window is between V_{DUTY_H} and V_{DUTY_L} when selecting R_{DUTY} to remove potential for error. To select a precise dimming value, use an E96 series resistor (see Table 2).

Table 2: Two-Step Dimming Duty vs. R_{DUTY}

Two-Step Dimming Duty	R_{DUTY} (Ω)
15%	61900
14%	41200
13%	27400
12%	18200
11%	12100
10%	7870
PWM dimming (two-step dimming inactivated)	4870

9%	3090
8%	2050
7%	1370
6%	887
5%	576

Table 2 shows the proposed R_{DUTY} in E96 series for different two-step dimming duties. These values consider the I_{DUTY} tolerance and $\pm 3\%$ resistor tolerance.

If V_{CC} drops below 4.05V before two-step dimming detection is finished, two-step dimming detection stops. Two-step dimming does not restart unless V_{CC} rises to 4.7V. The two-step dimming signal and two-step dimming duty are

latched once detection finishes, and only can be reset by VCC under-voltage lockout (UVLO), not EN shutdown. The two-step dimming frequency is typically about 500Hz (± 50 Hz).

Under-Voltage Lockout (UVLO)

Under-voltage lockout (UVLO) protects the chip from operating at an insufficient supply voltage. Both $V_{IN} - V_{INGND}$ and VCC have UVLO thresholds. $V_{IN} - V_{INGND}$ has a 6V rising UVLO threshold with a 1.1V hysteresis, while VCC has a 4.7V rising UVLO threshold with a 0.65V hysteresis. VIN and VCC UVLO do not trigger a fault.

Fault Detection Indicator

The MPQ7200 has fault indication (see Table 3 on page 46). The FAULT pin is the open drain of a MOSFET. FAULT is internally pulled up to VIN through a 300k Ω resistor, and pulled down to IGND with a 4M Ω resistor. The FAULT pin is pulled high during normal operation. FAULT is pulled low if any of the following faults occur: LED short or open, thermal shutdown, false mode detection, or over-current protection (OCP). This indicates a fault status. If the ISET or IREF pin experiences a short or open fault after the chip starts up, the FAULT pin can be asserted. If there is a short or open fault on the IDUTY pin, FAULT only asserts if the fault is detected before start-up.

The MPQ7200 senses the output by monitoring the average voltage on SW in buck mode, and the INGND voltage in buck-boost mode. If LED+ shorts to LED- or PGND, or if the output voltage drops below the under voltage (UV) threshold, then a short circuit is detected and FAULT asserts. If an LED open fault occurs, output over-voltage (OV) conditions are detected in buck-boost mode, or a low HS-FET current is detected in buck mode, then FAULT asserts.

The low-current rising threshold is 82mA, with a 22mA hysteresis if the LED current is falling and below 600mA, or is 166mA with a 46mA hysteresis if the LED current is falling and exceeds 600mA in buck mode. The low-current rising threshold is 166mA with a 46mA hysteresis if the LED current is falling in buck-boost mode. In buck mode, low-current detection is disabled when V_{IN} drops below 7.5V to stop the part from latching under cold-crank conditions. If LED+ (INGND) shorts to the battery

in buck-boost mode, then the $V_{IN} - INGND$ voltage is below its UV threshold, and the FAULT signal cannot be asserted. If LED- (PGND) is shorted to INGND, then the INGND voltage is below the INGND UV threshold and FAULT is asserted. If LED is open, then INGND exceeds its OV threshold and FAULT is asserted.

At high temperatures, the part operates normally with a reduced current level. The part only stops operating if the internal temperature reaches 170°C. Then over-temperature protection (OTP) is triggered, and FAULT is asserted.

If any fault occurs, the part stops switching, then the FAULT output asserts in 20 μ s, and the part is latched off. While the part is latched off, VCC is still present and the part consumes a <2mA current.

FAULT can be reset by VCC UVLO. If the device is not operating with two-step dimming mode, an EN shutdown (EN being driven low for longer than 25ms) can also reset the FAULT pin.

While the device powers on, the FAULT pin may stay inactive for about 25ms, but it is active by 40ms. During PWM dimming, the FAULT counter works only when the dimming signal is high, so the inactive time is 30ms/PWM dimming duty. This prevents false system functions when multiple parts have connected FAULT pins and share the same EN signal. However, individual parts are self-protected and latch off immediately if a fault condition is detected, regardless of whether FAULT asserts.

The FAULT pin can withstand a 30mA current and protect itself even if the pin shorts to a high voltage (e.g. the battery voltage). If FAULT is low (<1.6V), FAULT's sink current increases to enhance the pull-down capability. Figure 4 shows a detailed FAULT sink current when the FAULT pin is pulled low to a different voltage.

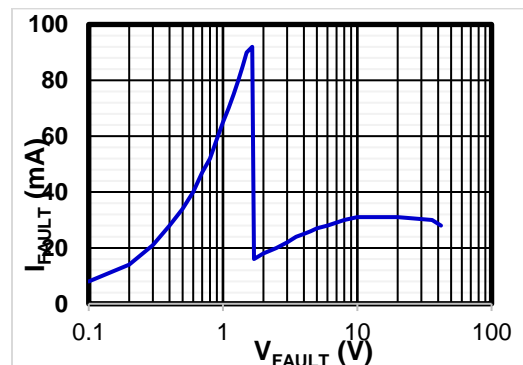

Figure 4: FAULT Sink Current vs. FAULT Voltage

During PWM dimming or two-step dimming, fault conditions may not be properly detected when the dimming on time is shorter than 100 μ s. Ensure that the dimming on time is always longer than 100 μ s so that fault detection operates correctly.

Table 3: Fault Detection ⁽⁸⁾

Fault Condition	Detection	
	Buck	Buck-Boost
LED+ shorted to LED-	V_{OUT} under-voltage (UV) ($V_{OUT} < 1.1V$)	INGND UV ($V_{INGND} - V_{PGND} < 1.35V$) ⁽⁹⁾
LED+ shorted to PGND	V_{OUT} UV ($V_{OUT} < 1.1V$)	INGND UV ($V_{INGND} - V_{PGND} < 1.35V$)
LED+ shorted to INGND	V_{OUT} UV ($V_{OUT} < 1.1V$)	Normal conditions
LED+ shorted to battery	Low LED current	Cannot assert FAULT due to $V_{IN} - V_{INGND}$ UVLO
LED- shorted to INGND	Normal conditions	INGND UV ($V_{INGND} - V_{PGND} < 1.35V$)
LED- shorted to battery	Cannot assert FAULT due to $V_{IN} - V_{INGND}$ UVLO	N/A ⁽¹⁰⁾
LED open fault	Low LED current	INGND OV ($V_{INGND} - V_{PGND} > 18V$)
MODE detection Is incorrect	$V_{INGND} - V_{PGND} > 1.35V$	INGND UV ($V_{INGND} - V_{PGND} < 1.35V$)
Over-temperature protection (OTP)	$T_J > 170^{\circ}C$, or $0.18V < V_{NTC} < 0.38V$ for longer than 256 μ s	
ISET short fault ⁽¹¹⁾	($I_{SET} > 120\mu A$ when $I_{LED_SETTING} < 600mA$) ($I_{SET} > 220\mu A$ when $I_{LED_SETTING} > 600mA$)	$I_{SET} > 110\mu A$
ISET open fault ⁽¹¹⁾	$I_{SET} < 1.4\mu A$	
IREF short ⁽¹¹⁾	$I_{REF} > 90\mu A$	$I_{REF} > 900\mu A$
IREF open fault ⁽¹¹⁾	$I_{REF} < 3\mu A$	$I_{REF} < 40\mu A$
DUTY open fault ⁽¹²⁾	$V_{DUTY1} > 3.355V$	
DUTY short fault ⁽¹²⁾	$V_{DUTY2} < 0.302V$	
Over-current protection (OCP)	Current limit triggered 3 consecutive times	
Low LED current protection ⁽¹³⁾	$I_{LED_RISING} < 82mA$ with a 22mA hysteresis if the LED current is falling when $I_{LED_SETTING} < 600mA$; $I_{LED_RISING} < 166mA$ with a 46mA hysteresis if the LED current is falling when $I_{LED_SETTING} > 600mA$	$I_{LED_RISING} < 166mA$ with a 46mA hysteresis if the LED current is falling

Notes:

- 8) If a fault mentioned in this table is detected, the part latches off and FAULT is asserted.
- 9) The FAULT pin may not work correctly if INGND - PGND is pulled below -0.3V or if an LED+ short to LED- occurs with a long cable.
- 10) Not applicable. If an LED- short to battery in buck-boost mode occurs, the negative voltage ($V_{INGND-PGND}$) may cause damage to the IC.
- 11) The part latches off and FAULT asserts if the ISET or IREF pins experience a short or open fault before or after start-up.
- 12) The part latches off and FAULT asserts if an IDUTY pin short or open fault occurs before start-up. After start-up, an IDUTY short or open fault cannot be detected.
- 13) To avoid unintentionally triggering low LED current protection, the LED current should not be set below the low LED current rising threshold. The LED current also should not be below the low LED current rising threshold while power derating is active in buck-boost mode.

Over-Current Protection (OCP)

The MPQ7200 has cycle-by-cycle peak current limit protection. The inductor current is monitored while the HS-FET is on. If the inductor current exceeds the current limit value (about 6.3A when the LED current is set above 600mA, and 3.15A when the LED current is set below 600mA, the HS-FET turns off immediately. Then the LS-FET turns on to discharge the energy, and the inductor current decreases. The HS-FET remains off unless the inductor current falls to 0A, at which point another HS-FET on cycle starts. If the over-current (OC) condition is still present after three consecutive retries, the part latches off and reports a failure as the FAULT pin is asserted.

Load Dump Protection

The MPQ7200's internal MOSFETs have a 50V absolute maximum rating, and a maximum 42V operating voltage. In buck topologies, this maximum voltage can handle load dump conditions up to 42V.

In buck-boost topologies, the voltage difference between V_{IN} and PGND is the sum of the car battery's voltage plus the LED voltage. Under load dump conditions, the MPQ7200 can exceed its maximum value.

To protect the part under load dump conditions in buck-boost mode, the MPQ7200 stops switching if $V_{IN} - V_{PGND}$ exceeds 40V. A 100mA sink current at INGND is activated to discharge the output voltage, so the MOSFET only detects the V_{IN} voltage stress. The part automatically restarts when $V_{IN} - V_{PGND}$ drops back to 39V. Load dump protection does not always trigger a fault, and it is not active in buck mode. Load dump protection can reset the FAULT status caused by other fault conditions, but it cannot reset the MPQ7200 if the part is latched.

Power Derating

If V_{IN} is below a specific voltage (typically 7V) in buck-boost mode, the power derating starts. The LED current drops linearly with V_{IN} due to analog dimming. Derating continues until V_{IN} reaches the under-voltage lockout (UVLO) threshold, then the LED current drops by 29%. During start-up, power derating is enabled in buck-boost mode. Power derating is always disabled in buck mode.

NTC Thermal Derating

Connect an NTC resistor network to the NTC pin to reduce the output current via analog dimming. This is especially useful when the sensed temperature exceeds the configured value. The LED current drops as the temperature rises. The activation of NTC and the dimming ratio are determined by the three-step NTC voltage (V_{NTC}) detection (see Figure 5).

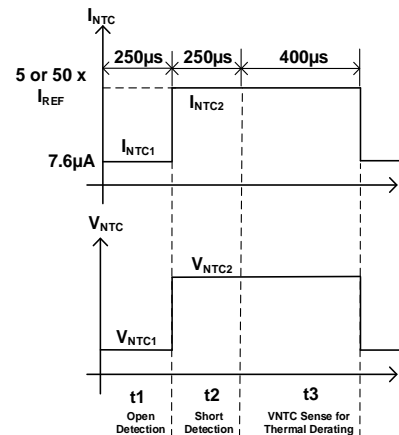

Figure 5: I_{NTC} Timing

At t_1 and t_2 , the voltage on the NTC pin is detected to determine if the NTC is enabled. t_1 and t_2 both last for 250µs. At t_3 , V_{NTC} is sensed. The dimming ratio is generated at the end of t_3 . t_3 lasts for 400µs.

During t_1 , the detection current (I_{NTC1}) is 7.6µA; during t_2 , it is 50 times I_{REF} (in buck mode) or 5 (in buck-boost mode) times I_{REF} (I_{NTC2}). To activate NTC thermal derating, the NTC voltage should be below 2V (with a <263kΩ resistor) during t_1 (V_{NTC1}), and above 0.38V (with a resistor that is based on the values of V_{NTC2} and I_{NTC2}) during t_2 . If V_{NTC1} exceeds 2V during t_1 , an open pin fault is detected. If V_{NTC2} falls below 0.18V during t_2 , a short fault is detected. An open or short fault deactivates NTC thermal derating.

To avoid triggering an open fault, V_{NTC1} must be below 2V, even if the NTC value is large at low temperatures. To avoid triggering a short fault, V_{NTC2} must exceed 0.18V, even if the NTC resistor is small at high temperatures.

If NTC thermal derating is activated at the end of t_2 , V_{NTC2} is sensed during t_3 to indicate the real temperature and determine the dimming ratio.

The dimming ratio decreases as V_{NTC2} decreases, starting when V_{NTC2} drops below 1.25V. The dimming ratio decreases by a step of 2% if V_{NTC2} drops by 30mV. If V_{NTC2} falls to 0.5V, the dimming ratio decreases to 50%. This means the LED average current also falls to 50% of the set LED current.

If V_{NTC2} continues to drop, and is between 0.5V and 0.38V, the thermal derating stays at 50%. If V_{NTC2} is between 0.38V and 0.18V, the part latches off due to a thermal shutdown event and the device asserts the FAULT pin. The device restarts only after it is turned off then on again, or if EN is reset. If the voltage drops below 0.18V, the NTC pin is considered shorted to PGND, and the NTC circuitry is deactivated.

If the NTC pin is floating or connected to PGND, the LED current decreases to 50% of the set LED current. Connect a 10k Ω resistor between the NTC and PGND pins to disable the NTC thermal derating function.

Thermal Shutdown (TSD)

Thermal shutdown prevents the chip from operating at exceedingly high temperatures. If the die temperature exceeds 170°C, the entire chip shuts down, and FAULT is asserted. The device restarts only after being turned off then on again, or if EN is reset.

Floating Driver and Bootstrap Charging

An external bootstrap capacitor powers the floating power MOSFET driver. The bootstrap capacitor voltage is charged to about 5V from VCC through a pass transistor when the LS-FET is on.

This floating driver has its own under-voltage lockout (UVLO) protection, with a rising threshold of 2.5V and hysteresis of 700mV. If the BST-to-SW voltage drops to 2.2V, the LS-FET turns on to refresh the BST voltage. It is recommended to use a 47nF to 220nF ceramic capacitor for the bootstrap capacitor. Consider the capacitor's DC voltage and temperature derating when selecting the capacitor to ensure that the real capacitance is between 47nF and 200nF. A maximum 22 Ω resistor can be placed in series with the bootstrap capacitor to reduce SW voltage spikes.

The part integrates BST capacitor open detection functionality. When VIN and VCC reach their under-voltage lockout (UVLO) rising thresholds, the BST capacitor is charged after the 1ms thermal derating finishes. If the voltage on the BST capacitor reaches the UVLO rising threshold in 45 μ s, the part detects a BST open fault and latches off. If VIN restarts frequently, the BST capacitor may not be able to discharge sufficiently, and an open fault may be mistriggered. To avoid a mistrigger, place a small BST capacitor and a bleeding resistor in parallel with the BST capacitor. This ensures that the BST capacitor voltage is sufficiently low after a restart. It is recommended to use a 22nF capacitor and 15k Ω resistor (see Figure 7 on page 52).

APPLICATION INFORMATION

Selecting Buck or Buck-Boost Mode

The device can be configured for buck or buck-boost mode by connecting a different resistor at the IREF pin (R_{IREF}). Select a $1.05\text{k}\Omega \leq R_{IREF} \leq 9.09\text{k}\Omega$ resistor for buck-boost mode, and a $14.7\text{k}\Omega \leq R_{IREF} \leq 80.6\text{k}\Omega$ resistor for buck mode.

Dimming Mode Selection

The dimming mode can be configured by connecting a different resistor at the IDUTY pin (R_{IDUTY}). Select a $4.87\text{k}\Omega$ resistor to disable the internal PWM dimming function and enable external PWM dimming. Table 2 on page 44 lists resistors for two-step dimming, if that function is required.

Setting the LED Current

The external resistor connected to the ISET pin sets the LED current. The value of the external resistor can be calculated with Equation (2):

$$R_3 = \frac{16}{I_{LED} \text{ (A)}} \text{ (k}\Omega\text{)} \quad (2)$$

If I_{LED} is below 0.7A in buck-boost mode, certain resistors are recommended (see Table 4).

Table 4: Resistor Selection when $I_{LED} \leq 700\text{mA}$ in Buck-Boost Mode

I_{LED} (A)	R_{ISET} (k Ω)
0.7	22.6
0.65	24.2
0.6	26.1
0.55	23.2
0.5	30.9
0.45	34.0
0.4	37.4

Figure 6 shows the relationship between I_{LED} and R_{ISET} in buck-boost mode.

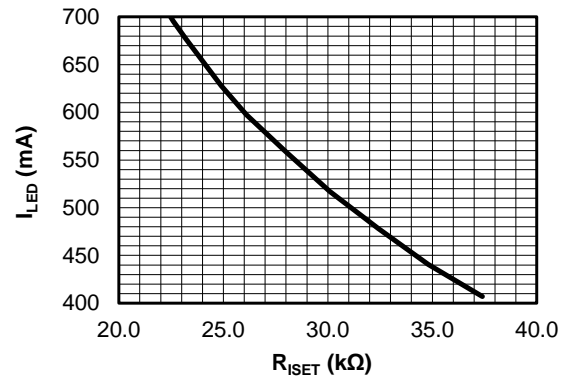

Figure 6: I_{LED} vs. R_{ISET} in BBI Mode when $I_{LED} \leq 700\text{mA}$

Set the LED current above 300mA in BBI mode. If $I_{LED_SETTING}$ is below 600mA, set the LED current above 60mA. If $I_{LED_SETTING}$ exceeds 600mA, set the LED current to 120mA. This is to avoid triggering low LED current latch protection.

Selecting the Inductor

For most applications, it is recommended to use an inductor between $2.2\mu\text{H}$ and $33\mu\text{H}$ with a DC current rating that exceeds the maximum inductor current. Include the DC resistance of the inductor when estimating the output current and the inductor's power consumption.

For buck mode, the required inductance value can be estimated with Equation (3):

$$L = \frac{V_{OUT} \times (V_{IN} - V_{OUT})}{V_{IN} \times \Delta I_L \times f_{SW}} \quad (3)$$

Choose an inductor ripple current that exceeds 20% of the LED current. The inductor peak current can be calculated with Equation (4):

$$I_{L_PEAK} = I_{L_AVG} + \frac{\Delta I_L}{2} \quad (4)$$

Where I_{L_AVG} is the average current through the inductor. In buck mode, I_{L_AVG} is equal to the output load current (LED current). Under light-load conditions, use a larger-value inductor to improve efficiency and current precision. Table 5 lists the recommended inductor values for common LED currents in buck mode.

Table 5: Buck Mode Inductor Values for Common LED Currents

I _{LED} (A)	Recommended Inductor Value (μH)
[2A, 3A]	3.3
[0.8A, 2A]	4.7
[0.4A, 0.8A]	6.8
[0.3A, 0.4A]	10

For buck-boost applications, estimate the required inductance value with Equation (5):

$$L = \frac{V_{OUT} \times V_{IN}}{(V_{OUT} + V_{IN}) \times \Delta I_L \times f_{SW}} \quad (5)$$

Where ΔI_L is the inductor's peak-to-peak current ripple.

ΔI_L should exceed 25% of the inductor average current when $I_{LED} > 0.7A$. Select ΔI_L to exceed 20% of the inductor average current when $I_{LED} < 0.7A$. I_{L_AVG} can be calculated with Equation (6):

$$I_{L_AVG} = I_{LED} \times \left(1 + \frac{V_{OUT}}{V_{IN}}\right) \quad (6)$$

The peak inductor current can be calculated with Equation (7):

$$I_{L_PEAK} = I_{L_AVG} + \frac{\Delta I_L}{2} \quad (7)$$

Under light-load conditions, use a larger-value inductor to improve efficiency and current precision. Table 6 lists the recommended inductor values for common I_{LED} currents in buck-boost mode.

Table 6: Buck-Boost Mode Inductor Values for Common I_{LED} Currents

I _{LED} (A)	Recommend Inductor Value (μH)
(1A, 1.2A]	3.3
(0.8A, 1A]	4.7
(0.6A, 0.8A]	6.8
[0.4A,0.6A]	10

Selecting the Input Capacitor

The device has a discontinuous input current in both buck and buck-boost mode, and requires a capacitor to supply AC current to the converter while maintaining the DC input voltage. For the best performance, use low-ESR capacitors. Ceramic capacitors with X5R or X7R dielectrics

are highly recommended because of their low ESR and small temperature coefficients.

For most applications, use a 4.7μF to 22μF capacitor. The input capacitor can be electrolytic, tantalum, or ceramic. When using electrolytic or tantalum capacitors, it is strongly recommended to use an additional lower-value capacitor (e.g. 0.1μF) with a small package size (0603) to absorb high-frequency switching noise. Place the smaller capacitor as close to VIN and GND (INGND = PGND in buck mode, for both INGND and PGND in buck-boost mode) as possible.

Since C_{IN} absorbs the input switching current in buck mode, the device requires an adequate ripple current rating. The RMS current in the input capacitor can be estimated with Equation (8):

$$I_{CIN} = I_{LOAD} \times \sqrt{\frac{V_{OUT}}{V_{IN}} \times \left(1 - \frac{V_{OUT}}{V_{IN}}\right)} \quad (8)$$

The worst-case condition occurs at $V_{IN} = 2V_{OUT}$, calculated with Equation (9):

$$I_{CIN} = \frac{I_{LOAD}}{2} \quad (9)$$

For simplification, choose an input capacitor with an RMS current rating greater than half of the maximum load current. The input voltage ripple caused by the capacitance can be estimated with Equation (10):

$$\Delta V_{IN} = \frac{I_{LOAD}}{f_{SW} \times C_{IN}} \times \frac{V_{OUT}}{V_{IN}} \times \left(1 - \frac{V_{OUT}}{V_{IN}}\right) \quad (10)$$

If $I_{BANDVALLEY} \geq I_{LED}$ in buck-boost mode, the capacitance can be calculated with Equation (11):

$$\Delta V_{IN} = \frac{I_{LED} \times V_{OUT}}{(V_{IN} + V_{OUT}) \times f_{SW} \times C_{IN}} \quad (11)$$

In buck-boost mode, consider the capacitor between VIN and PGND for VCC regulator stability and improved EMC performance. If $(V_{INGND} - V_{PGND}) > 5.1V$, the input of the VCC regulator switches to V_{INGND} to reduce power loss. Place a 0.44μF to 1.2μF ceramic capacitor between VIN and PGND to stabilize VCC when the VCC charging source changes from VIN to INGND. Two symmetric (0.1μF + 0.47μF) / 50V

X7R ceramic capacitors can be placed between VIN and PGND.

Selecting the Output Capacitor

The output capacitor maintains the DC output voltage. Ceramic, tantalum, or low-ESR electrolytic capacitors are recommended. For the best results, use low-ESR capacitors to keep the output voltage ripple low.

In buck mode, the output voltage ripple can be estimated with Equation (12):

$$\Delta V_{OUT} = \frac{V_{OUT}}{f_{SW} \times L} \times \left(1 - \frac{V_{OUT}}{V_{IN}}\right) \times \left(R_{ESR} + \frac{1}{8 \times f_{SW} \times C_{OUT}}\right) \quad (12)$$

Where L is the inductor value, and R_{ESR} is the equivalent series resistance (ESR) value of the output capacitor.

For ceramic capacitors, the capacitance dominates the impedance at the switching frequency, and the capacitance causes the majority of the output voltage ripple. For simplification, the output voltage ripple can be estimated with Equation (13):

$$\Delta V_{OUT} = \frac{V_{OUT}}{8 \times f_{SW}^2 \times L \times C_{OUT}} \times \left(1 - \frac{V_{OUT}}{V_{IN}}\right) \quad (13)$$

For tantalum or electrolytic capacitors, the ESR dominates the impedance at the switching frequency. For simplification, the output ripple can be estimated with Equation (14):

$$\Delta V_{OUT} = \frac{V_{OUT}}{f_{SW} \times L} \times \left(1 - \frac{V_{OUT}}{V_{IN}}\right) \times R_{ESR} \quad (14)$$

If $I_{BANDVALLEY} \geq I_{LED}$ in buck-boost applications, the output capacitor can be calculated with Equation (15):

$$\Delta V_{OUT} = I_{LED} \times \left(R_{ESR} + \frac{V_{OUT}}{f_{SW} \times C_{OUT} \times (V_{IN} + V_{OUT})}\right) \quad (15)$$

For tantalum or electrolytic capacitors, the ESR dominates the impedance at the switching frequency. For simplification, the output ripple can be estimated with Equation (16):

$$\Delta V_{OUT} = I_{LED} \times R_{ESR} \quad (16)$$

A 10 μ F to 22 μ F ceramic capacitor is sufficient for most applications. Two symmetric 4.7 μ F/25V X7R ceramic capacitors can be placed between LED+ and LED-.

Selecting the Diode from PGND to INGND in Buck-Boost Mode

If the device is operating in buck-boost mode, place a Schottky diode between INGND and PGND to direct the charge current of the capacitor connected between VIN and PGND, especially when the VIN slew rate is high. When $(V_{INGND} - V_{PGND}) < 5.1V$, VCC is powered by VIN. The VCC charge current flows from the VCC capacitor to PGND, then back to INGND and then the car battery. For this application, it is recommended to use a Schottky diode with a low forward voltage (V_F) of about 0.32V, with a 1A current rating and >20V VRRM voltage. A PMEG2010EPAS Schottky diode is recommended.

Selecting the VCC Capacitor

A small VCC capacitor causes ringing on VCC, and makes the MOSFET unstable. It is recommended to place a $\geq 3\mu$ F decoupling ceramic capacitor at the VCC pin. When selecting a capacitor, consider the capacitance derating to ensure that the real capacitance is at least 3 μ F. A 10 μ F X7R with a $\geq 10V$ DC rated voltage capacitor is recommended. VCC is the reference to PGND/AGND.

Selecting the BST Resistor and Capacitor

It is recommended to place a resistor in series with the BST capacitor to reduce the SW spike voltage. A higher resistance reduces SW spikes, but it also reduces efficiency. It is recommended to use a 22nF to 220nF ceramic capacitor with 10/16V DC derating.

Consider efficiency and EMI performance when choosing a resistor. Choose a maximum 22 Ω resistor with a 0603/0402 package, as a large package is not required. During normal operation, the average current flowing through the bootstrap resistor is about 20mA in buck mode and 10mA in buck-boost mode. If the capacitor is shorted, the current inside the resistor is limited by the internal LDO. The device can quickly detect a failure if the LED current falls below its low limit. Then the part latches off, and current is no longer sourced to the resistor. A 0402 package can handle power dissipation on the bootstrap resistor.

The part integrates BST capacitor open detection functionality. When VIN and VCC reach their under-voltage lockout (UVLO) rising

thresholds, the BST capacitor is charged after the 1ms thermal derating finishes. If the voltage on the BST capacitor reaches the UVLO rising threshold in 45 μ s, the part detects a BST open fault and latches off. If VIN restarts frequently, the BST capacitor may not be able to discharge sufficiently, and an open fault may be mistriggered. To avoid a mistrigger, place a small BST capacitor and a bleeding resistor in parallel with the BST capacitor. This ensures that the BST capacitor voltage is sufficiently low after a restart. It is recommended to use a 22nF capacitor and 15k Ω resistor (see Figure 7).

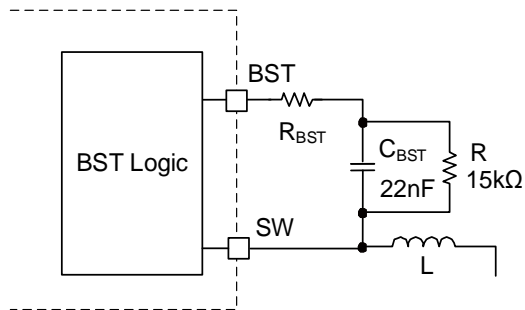
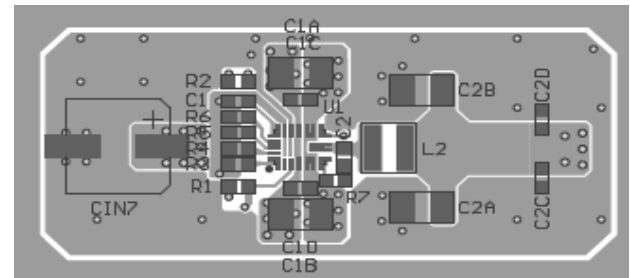

Figure 7: Recommended BST Circuitry for a VIN Hot-Plug Application

PCB Layout Guidelines ⁽¹⁴⁾ ⁽¹⁵⁾

Efficient PCB layout, especially input capacitor placement, is critical for stable operation. A 4-layer layout is strongly recommended to improve thermal performance. For the best results, refer to Figure 8 and Figure 9, and follow the guidelines below:

1. Place the symmetric ceramic input capacitor, especially the small package (0603) input bypass capacitor, as close to the VIN and PGND pins as possible to reduce high-frequency noise. Keep the connection between the input capacitor and VIN as short and wide as possible.
2. Directly connect the PGND pin to a large ground plane on the PCB.
3. If the bottom layer is a ground plane, add vias near PGND.
4. Ensure that the high-current paths at PGND and VIN have short, direct, and wide traces.
5. Make the connection between the input capacitor and VIN as short and wide as possible.
6. Place the VCC capacitor as close to VCC and PGND as possible.
7. Route SW and BST away from sensitive analog areas.
8. Use multiple vias to connect the power planes to the internal layers.



Top Layer

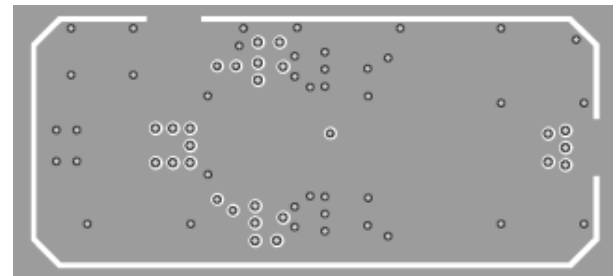

Mid-Layer 1

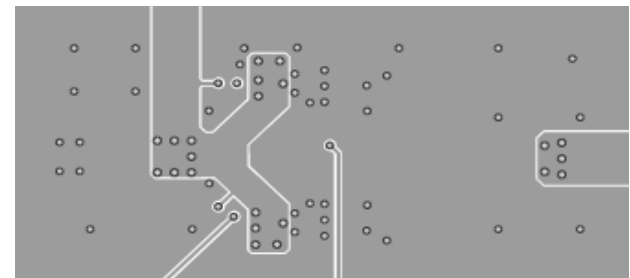

Mid-Layer 2

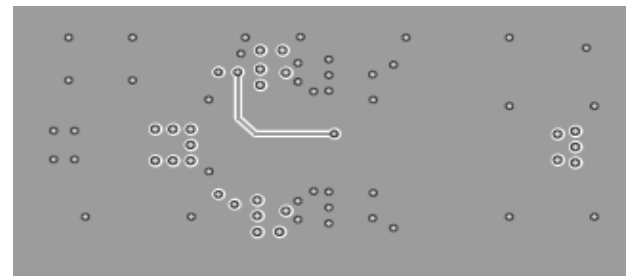

Bottom Layer

Figure 8: Recommended PCB Layout for Buck Mode ⁽¹⁴⁾

Notes:

- 14) The recommended PCB layout for buck mode is based on Figure 10.
- 15) The recommended layout for buck-boost mode is based on Figure 11 on page 55.

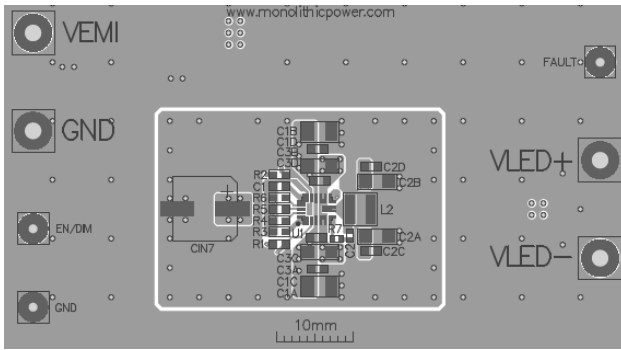

Top Layer

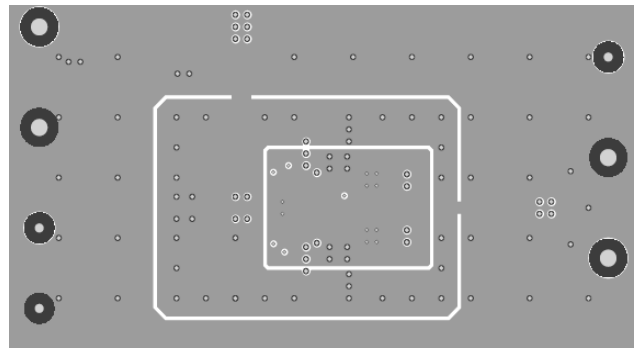

Mid-Layer 1

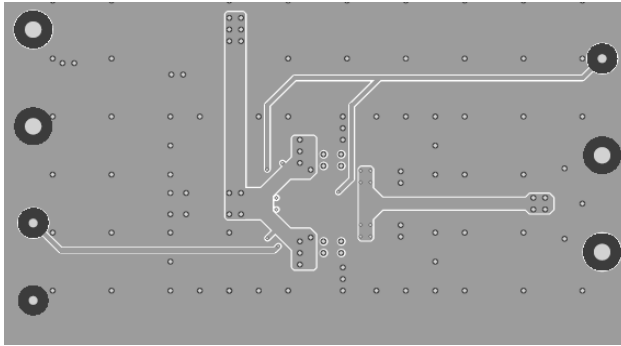

Mid-Layer 2

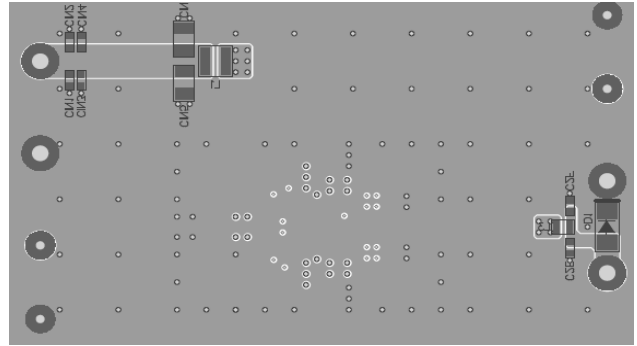

Bottom Layer

Figure 9: Recommended PCB Layout for Buck-Boost Mode ⁽¹⁵⁾

TYPICAL APPLICATION CIRCUITS

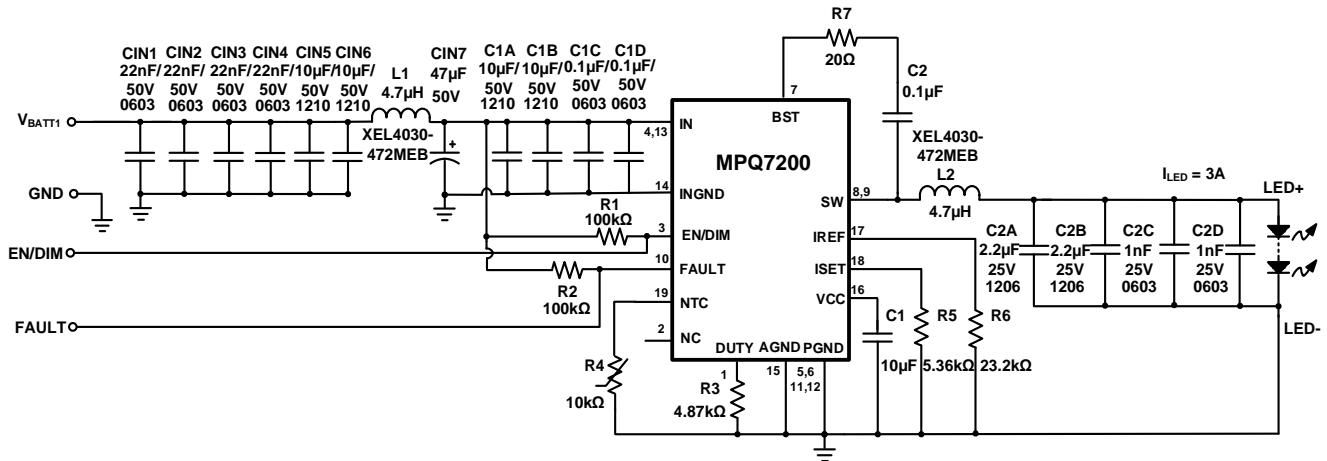

Figure 10: Typical Application Circuit (Buck Mode, $I_{LED} = 3A$, No Two-Step Dimming)

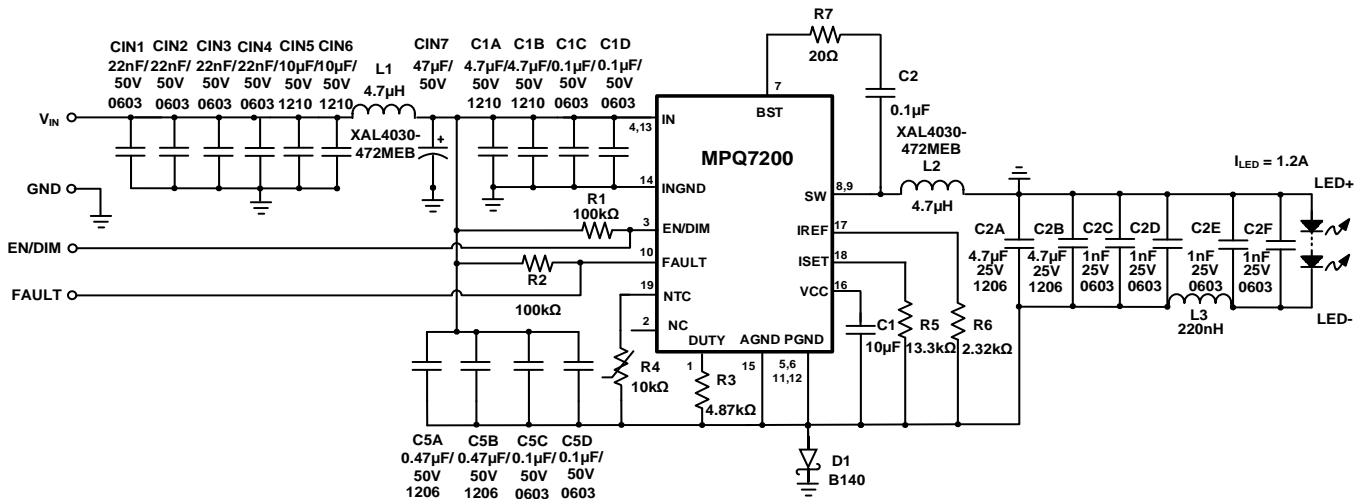

Figure 11: Typical Application Circuit (Buck-Boost Mode, $I_{LED} = 1.2A$, No Two-Step Dimming)

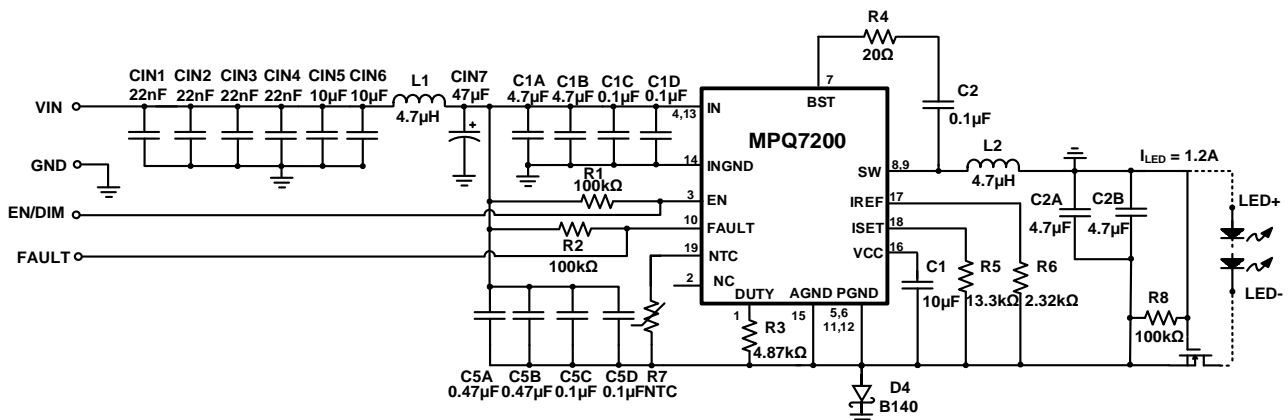
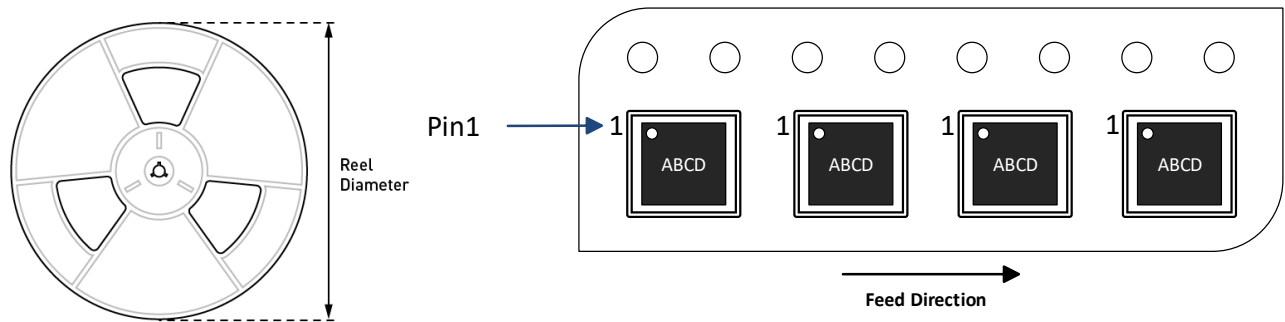

Figure 12: Typical Application Circuit (Buck-Boost Mode, $I_{LED} = 1.2A$, LED+ Short to Battery Protection)

CARRIER INFORMATION



Part Number	Package Description	Quantity/ Reel	Quantity/ Tube	Quantity/ Tray	Reel Diameter	Carrier Tape Width	Carrier Tape Pitch
MPQ7200GLE-AEC1-Z	QFN-19 (3mmx4mm)	5000	N/A	N/A	13in	12mm	8mm

REVISION HISTORY

Revision #	Revision Date	Description	Pages Updated
1.0	10/9/2020	Initial Release	-
1.1	2/22/2023	Added the new part number (MPQ7200GLE) to the Ordering Information section; updated the “-Z” suffix to “-Z”	3
		Updated the EN/DIM pin description	4
		Grammar and formatting revisions	12–14
		Added the number of LEDs to the conditions of the Efficiency with 2 LEDs and Efficiency with 1 LED curves	20
		Updated the V_{FAULT} channel name to “ V_{FAULT} 10V/div.” for the first Two-Step Dimming waveform	22
		Updated the V_{FAULT} channel name to “ V_{FAULT} 10V/div.” for the second Two-Step Dimming waveform	24
		Added the number of LEDs to the conditions of the Efficiency with 3 LEDs and Efficiency with 4 LEDs curves	33
		Updated the Enable (EN) Control section	42
		Updated the Pulse-Width Modulation (PWM) Dimming section	43
		Updated the Fault Detection Indicator section	45
		Updated Table 3; updated the Notes section	47
		Updated the Power Derating section	48
		Updated the NTC Thermal Derating section	49
		Updated the Setting the LED Current section; updated Figure 6	50
		Updated the PCB Layout Guidelines section; updated the Notes section; updated Figure 8; updated Figure 9	54–55
		Updated Figure 11; updated the figure titles for Figure 10, Figure 11, and Figure 12	56
Updated the Package Information section	57		
Updated the “-Z” suffix to “-Z”	58		

Notice: The information in this document is subject to change without notice. Please contact MPS for current specifications. Users should warrant and guarantee that third-party Intellectual Property rights are not infringed upon when integrating MPS products into any application. MPS will not assume any legal responsibility for any said applications.