

MODEL 802S - STAINLESS STEEL ENCODER

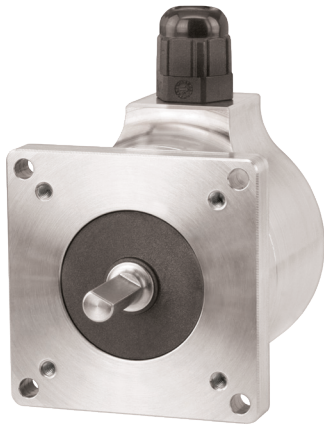

Ø2.0"

FEATURES

- Standard Size 20 (2.0" diameter) stainless steel package
- Up to 30,000 CPR
- Flange and servo mounting
- 80 lb max. axial and radial shaft loading
- IP67 sealing available

The Model 802S Accu-Coder® is a heavy duty, industry standard Size 20 (2.0" diameter) encoder specifically designed for harsh factory and plant floor environments. The Model 802S is available with a variety of flange and servo mounting styles, making it easy to use in a broad range of applications. Its heavy duty, double-shielded ball bearings are rated at 80 pounds maximum axial and radial shaft load, ensuring long operating life. This ultra-rugged yet compact encoder is housed in a Type 316 Stainless Steel enclosure, making it ideal for applications where contamination or exposure to caustic chemicals is a concern. Even with its tough exterior, the Model 802S provides the precise, reliable output you've come to expect from Accu-Coder®.

COMMON APPLICATIONS

Food Processing, Oil, Gas and Chemical Processing, Material Handling, Conveyors, Robotics, Elevator Controls, Textile Machines

MODEL 802S ORDERING GUIDE

Blue type indicates price adder options. Not all configuration combinations may be available. Contact Customer Service for details.

802S	20	S	1000	R	HV	1	F	1	E	G	CE
MODEL 802S Size 20 (2.0")	OPERATING TEMPERATURE S 0° to 70° C L -40° to 70° C ³ H 0° to 100° C ⁴	SHAFT SIZE¹ 07 0.250", 1/4" 20 0.375", 3/8" 21 10 mm 30 0.375", 3/8" ²	CYCLES PER REVOLUTION 1-30,000 See CPR Options below Price adder for >1270	OUTPUT TYPE 5 - 28V In/Out ⁶ OC Open Collector PU Pull-Up Resistor PP Push-Pull HV Line Driver ⁷ 8 - 28V In/5V Out ^{8, 9} H5 Line Driver (5V) ⁷ P5 Push-Pull (5V)	MOUNTING Flange Mounts F 1.181" Female pilot L 0.687" Male pilot G 1.250" Male pilot K Size 25 w/30 shaft Servo Mounts S 1.181" Female pilot U 0.687" Male pilot T 1.250" Male pilot J Size 25 w/30 shaft	CONNECTOR LOCATION E End S Side	CONNECTOR TYPE¹¹ G Gland, 24" Cable ¹² J 5-pin M12 (12 mm) ^{7, 13} K 8-pin M12 (12 mm) standard wiring ¹³ Z 8-pin M12 (12 mm) optional wiring ¹³	CERTIFICATION N None CE CE Marked ¹⁴	NUMBER OF CHANNELS⁵ A Channel A Channel A Leads B Q Quadrature A & B R Quadrature A & B with Index Channel B Leads A K Reverse Quadrature A & B D Reverse Quadrature A & B with Index	MAXIMUM FREQUENCY 1 Standard 100 kHz 2 200 kHz ≤ 3000 CPR 5 250 kHz, > 3000 CPR 3 500 kHz, > 6000 CPR ¹⁰ 4 1 MHz, > 10,000 CPR ¹⁰	SEALING N No seal 1 IP66 2 IP64 5 IP67

NOTES:

- Contact Customer Service for additional options.
- Shaft with Size 25 Mounting Adapter, J or K mounting only.
- Low temperature option not available with resolutions of 3000 CPR or higher.
- 0° to 85° C for certain resolutions, see CPR Options.
- Contact Customer Service for non-standard index gating options.
- 24 VDC max for high temperature option.
- Line Driver Outputs not available with 5-pin M12 connector.
- Standard temperature, 60 to 3000 CPR only. Not available with 2540 CPR.
- CE not available with H5/P5 output type options.
- Standard cable lengths only. For details, please refer to Technical Bulletin TB-116: Noise and Signal Distortion Considerations at encoder.com.
- For mating connectors, cables, and cordsets see Accessories at encoder.com. For Connector Pin Configuration Diagrams, see Technical Information or see Connector Pin Configuration Diagrams at encoder.com.
- For non-standard cable lengths, add a forward slash (/) plus cable length expressed in feet. Example: G/6 = 6 feet of cable.
- M12 connector available on side mount option only.
- Please refer to Technical Bulletin TB-100: When to Choose the CE Mark at encoder.com.

Model 802S CPR Options

0001*	0002*	0004*	0005*	0006*	0007*	0008*	0010*	0011*
0012*	0014*	0020	0021*	0024*	0025*	0028*	0030*	0032*
0033*	0034*	0035*	0038*	0040*	0042*	0045*	0050*	0060
0064*	0100	0120	0125	0128*	0144*	0150*	0160*	0192*
0200	0240*	0250	0254*	0256*	0300	0333*	0336*	0360
0400	0500	0512	0600	0625*	0635	0665*	0720	0889
1000	1024	1200	1204 ^a	1250*	1270*	1440	1500	1800
2000	2048	2400*	2500	2540*	2880*	3000*	3600*	4000*
4096*	5000*	6000*	7200*	7500*	9000*	10,000*	10,240*	12,000*
12,500*	14,400*	15,000*	18,000*	20,000*	20,480*	25,000*	30,000*	

* Contact Customer Service for High Temperature Option (H).

^a High Temperature Option (H) limited to 85° C maximum for these CPR options.

New CPR values are periodically added to those listed. Contact Customer Service to determine all currently available CPR values. Special disk resolutions are available upon request. A one-time NRE fee may apply.

MODEL 802S - STAINLESS STEEL ENCODER

MODEL 802S SPECIFICATIONS

Electrical

Input Voltage.....	4.75 to 28 VDC max for temperatures up to 70° C 4.75 to 24 VDC for temperatures between 70° C and 100° C
Input Current.....	100 mA max with no output load
Input Ripple.....	100 mV peak-to-peak at 0 to 100 kHz
Output Format.....	Incremental – Two square waves in quadrature with channel A leading B for clockwise shaft rotation, as viewed from the encoder mounting face. See Waveform Diagrams.
Output Types.....	Open Collector – 100 mA max per channel Pull-Up – Open Collector with 2.2k ohm internal resistor, 100 mA max per channel Push-Pull – 20 mA max per channel Line Driver – 20 mA max per channel (Meets RS 422 at 5 VDC supply)

Index.....Occurs once per revolution. The index for units >3000 CPR is 90° gated to Outputs A and B. See Waveform Diagrams.

Max Frequency.....Up to 1 MHz.

Electrical Protection.....Reverse voltage and output short circuit protected.
NOTE: Sustained reverse voltage may result in permanent damage.

Noise Immunity.....Tested to BS EN61000-4-2; IEC801-3;
BS EN61000-4-4; DDENV 50141;
DDENV 50204; BS EN55022
(with European compliance option);
BS EN61000-6-2; BS EN50081-2

Symmetry.....1 to 6000 CPR: 180° (±18°) electrical at 100 kHz output
6001 to 30,000 CPR: 180° (±36°) electrical

Quad Phasing.....1 to 6000 CPR: 90° (±22.5°) electrical at 100 kHz output
6001 to 30,000 CPR: 90° (±36°) electrical

Min Edge Sep.....1 to 6000 CPR: 67.5° electrical at 100 kHz output
6001 to 20,480 CPR: 54° electrical
>20,480 CPR: 50° electrical

Rise Time.....Less than 1 microsecond

Accuracy.....Instrument and Quadrature Error: For 200 to 1999 CPR,
0.017° mechanical (1.0 arc minutes) from one cycle to any other cycle.
For 2000 to 3000 CPR, 0.01° mechanical (0.6 arc minutes) from one cycle to any other cycle. Interpolation error (units >3000 CPR only) within 0.005° mechanical. (Total Optical Encoder Error = Instrument + Quadrature + Interpolation)

Mechanical

Max Shaft Speed.....	8000 RPM. Higher shaft speeds may be achievable, contact Customer Service.
Radial Shaft Load.....	80 lb max. Rated load of 20 to 40 lb for bearing life of 1.5 x 10 ⁹ revolutions
Axial Shaft Load.....	80 lb max. Rated load of 20 to 40 lb for bearing life of 1.5 x 10 ⁹ revolutions
Starting Torque.....	1.0 oz-in typical with IP64 seal or no seal 3.0 oz-in typical with IP66 shaft seal 7.0 oz-in typical with IP67 shaft seal
Moment of Inertia.....	5.2 x 10 ⁻⁴ oz-in-se ²
Housing.....	Type 316 Stainless Steel
Bearings.....	Precision ABEC ball bearings
Weight.....	1.5 lb typical

Environmental

Storage Temp.....	-25° to 85° C
Humidity.....	98% RH non-condensing
Vibration.....	20 g @ 58 to 500 Hz
Shock.....	75 g @ 11 ms duration
Sealing.....	IP50 standard; IP64, IP66, IP67 optional

MODEL 802S SERVO MOUNT (S)

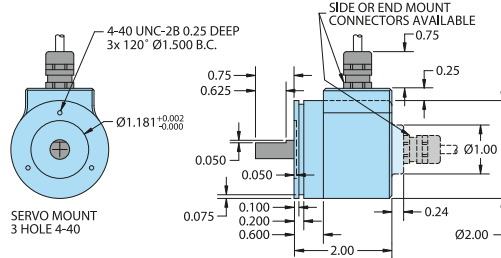

MODEL 802S FLANGE MOUNT (F)

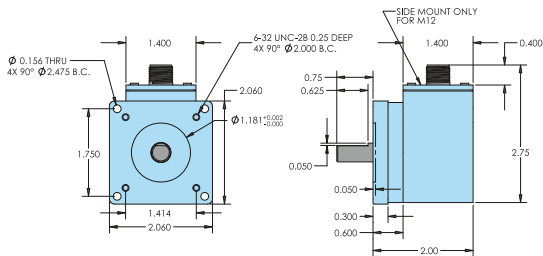

MODEL 802S SIZE 25 (2.5") SERVO MOUNT (J)

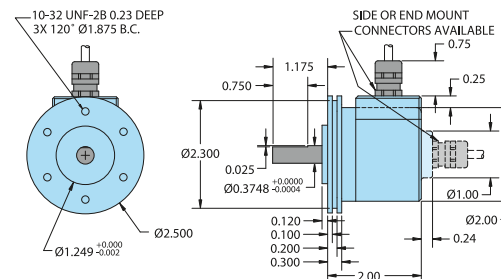

MODEL 802S SIZE 25 (2.5") FLANGE MOUNT (K)

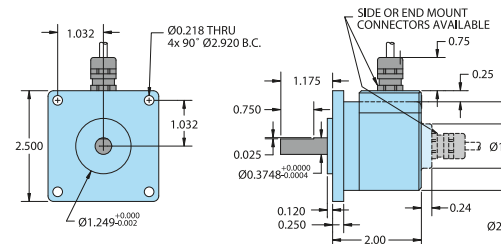

All dimensions are in inches with a tolerance of ± 0.005 " or ± 0.01 " unless otherwise specified. Metric dimensions are given in brackets [mm].

MODEL 802S - STAINLESS STEEL ENCODER

WAVEFORM DIAGRAMS

Line Driver and Push-Pull

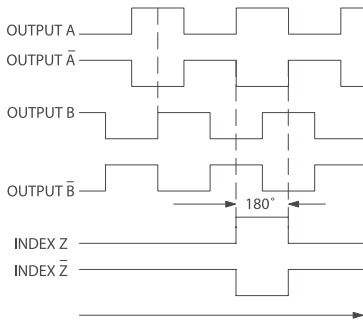

CLOCKWISE ROTATION AS VIEWED FROM THE MOUNTING FACE

NOTE: ALL DEGREE REFERENCES ARE ELECTRICAL DEGREES. Waveform shown with optional complementary signals \bar{A} , \bar{B} , \bar{Z} for HV and H5 outputs only.

Open Collector and Pull-Up

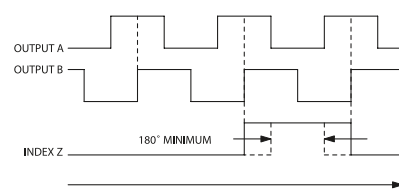

CLOCKWISE ROTATION AS VIEWED FROM THE MOUNTING FACE

NOTE: ALL DEGREE REFERENCES ARE ELECTRICAL DEGREES. Index is positive going.

WIRING TABLE

For EPC-supplied mating cables, refer to wiring table provided with cable. Trim back and insulate unused wires.

Function	Gland Cable† Wire Color	5-pin M12**	8-pin M12** Standard Wiring	8-pin M12** Optional Wiring
Com	Black	3	7	1
+VDC	Red	1	2	2
A	White	4	1	3
A'	Brown	--	3	4
B	Blue	2	4	5
B'	Violet	--	5	6
Z	Orange	5	6	7
Z'	Yellow	--	8	8
Case	Green	--	--	--
Shield	Bare*	--	--	--

* CE Option: Cable shield (bare wire) is connected to internal case.

** CE Option: Use cable cordset with shield connected to M12 connector coupling nut.

† Standard cable is 24 AWG conductors with foil and braid shield.