



## GaAs MMIC SPDT NON-REFLECTIVE SWITCH, DC - 20 GHz

### Features

- High Isolation: >45 dB up to 5 GHz  
>35 dB up to 20 GHz
- Low Insertion Loss: 2 dB @ 12 GHz  
2.5 dB @ 16 GHz
- Fast Switching
- Non-Reflective Design
- Hermetically Sealed Module
- Field Replaceable SMA connectors
- 55 °C to +85 °C Operating Temperature

### Typical Applications

The HMC-C011 is ideal for:

- Basestation Infrastructure
- Fiber Optics & Broadband Telecom
- Microwave Radio & VSAT
- Military Radios, Radar, & ECM
- Test Instrumentation

### General Description

The HMC-C011 is a general purpose broadband high isolation non-reflective GaAs MESFET SPDT switch housed in a miniature hermetic module with field replaceable SMA connectors. Covering DC to 20 GHz, the switch offers high isolation and low insertion loss. The switch features >45 dB isolation up to 5 GHz and >35 dB isolation up to 20 GHz. CMOS interface allows a single positive +5V bias voltage at very low DC currents.

### Functional Diagram

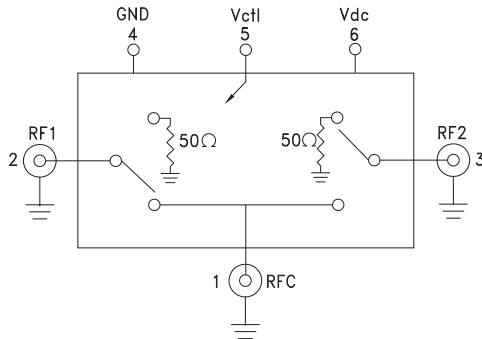

### Electrical Specifications, $T_A = +25^\circ C$ , With $V_{dc} = +5V$ & $0/+5V$ Control, 50 Ohm System

Parameter	Frequency	Min.	Typ.	Max.	Units
Insertion Loss	DC - 4.0 GHz		1.8	2.3	dB
	DC - 12.0 GHz		2.0	2.5	dB
	DC - 16.0 GHz		2.5	3.5	dB
	DC - 20.0 GHz		4.0	4.9	dB
Isolation	DC - 4.0 GHz	41	46		dB
	DC - 8.0 GHz	35	40		dB
	DC - 20.0 GHz	25	35		dB
Return Loss	"On State"	DC - 12.0 GHz	15		dB
		DC - 20.0 GHz	10		dB
Return Loss RF1, RF2	"Off State"	DC - 10.0 GHz	20		dB
		DC - 15.0 GHz	15		dB
		DC - 20.0 GHz	10		dB
Input Power for 1 dB Compression	0.5 - 20.0 GHz	20	23		dBm
Input Third Order Intercept (Two-Tone Input Power= +7 dBm Each Tone)	0.5 - 10.0 GHz		48		dBm
	0.5 - 20.0 GHz		45		dBm
Switching Characteristics	DC - 20 GHz	tRISE, tFALL (10/90% RF)	1.3		ns
		tON, tOFF (50% CTL to 10/90% RF)	5.0		ns
		Switching Transients	20		mVpp

Information furnished by Analog Devices is believed to be accurate and reliable. However, no responsibility is assumed by Analog Devices for its use, nor for any infringements of patents or other rights of third parties that may result from its use. Specifications subject to change without notice. No license is granted by implication or otherwise under any patent or patent rights of Analog Devices. Trademarks and registered trademarks are the property of their respective owners.

For price, delivery, and to place orders: Analog Devices, Inc., One Technology Way, P.O. Box 9106, Norwood, MA 02062-9106  
Phone: 781-329-4700 • Order online at [www.analog.com](http://www.analog.com)  
Application Support: Phone: 1-800-ANALOG-D



**GaAs MMIC SPDT NON-REFLECTIVE  
SWITCH, DC - 20 GHz**

**Insertion Loss**

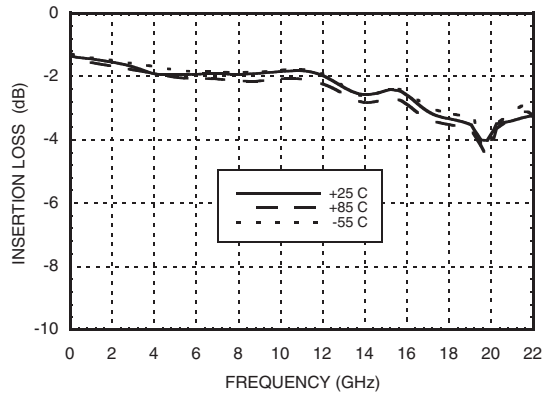

**Return Loss**

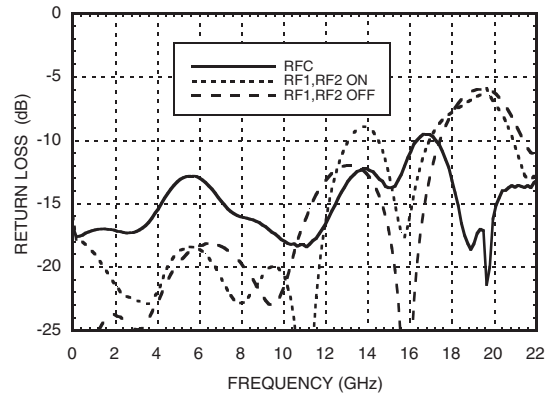

**Isolations**

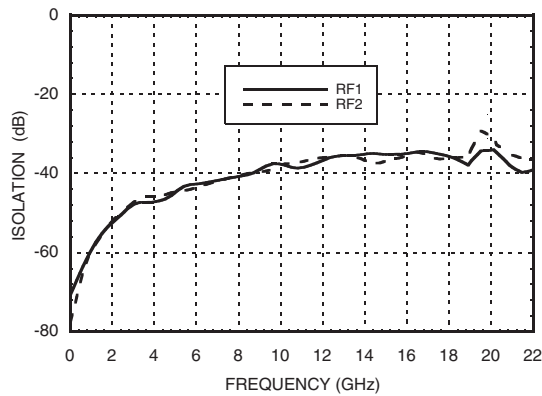

**Isolation Between Ports RF1 and RF2**

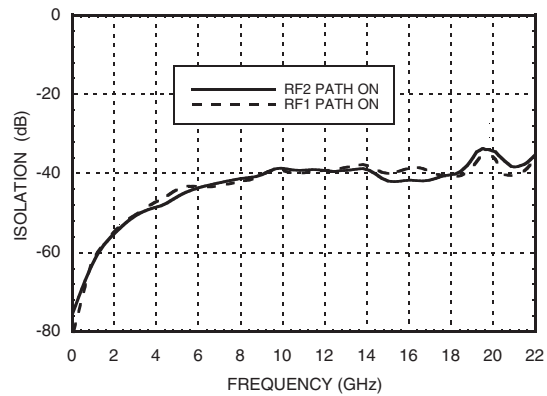

**Input P1dB & P0.1dB Compression Point**

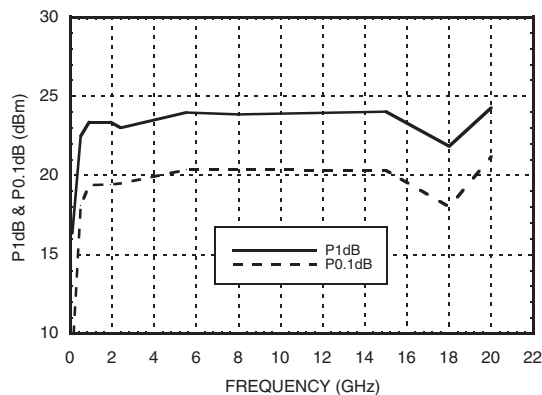

**Input Third Order Intercept Point**

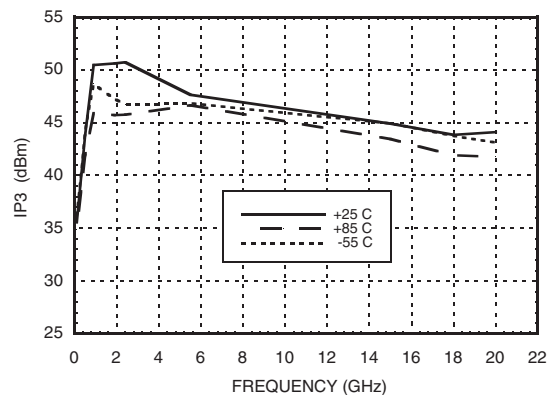

Information furnished by Analog Devices is believed to be accurate and reliable. However, no responsibility is assumed by Analog Devices for its use, nor for any infringements of patents or other rights of third parties that may result from its use. Specifications subject to change without notice. No license is granted by implication or otherwise under any patent or patent rights of Analog Devices. Trademarks and registered trademarks are the property of their respective owners.

For price, delivery, and to place orders: Analog Devices, Inc., One Technology Way, P.O. Box 9106, Norwood, MA 02062-9106 Phone: 781-329-4700 • Order online at [www.analog.com](http://www.analog.com) Application Support: Phone: 1-800-ANALOG-D

## GaAs MMIC SPDT NON-REFLECTIVE SWITCH, DC - 20 GHz



### Absolute Maximum Ratings

RF Input Power	+27 dBm
Supply Voltage (Vdc)	+7 Vdc
Control Voltage Range (Vctl)	-0.5V to Vdd +0.5V
Hot Switch Power Level	+23 dBm
Storage Temperature	-65 to +150 °C
Operating Temperature	-55 to +85 °C



**ELECTROSTATIC SENSITIVE DEVICE  
OBSERVE HANDLING PRECAUTIONS**

### Control Voltages

State	Bias Condition
High	+3.5 to Vdc @ 1 mA Typ.
Low	0 to +1.5V @ 20 µA Typ.

### Truth Table

Control Input	Signal Path State	
	RFC to RF1	RFC to RF2
High	On	Off
Low	Off	On

### Bias Voltage & Current

Vdc Range = +5 Vdc ± 10%	
Vdc (Vdc)	Idc (Typ.) (mA)
+5.0	1.4

(Bias current increases with switching rate to 15 - 20 mA.)

### Pin Descriptions

Pin Number	Function	Description	Interface Schematic
1, 2, 3	RFC, RF1, RF2	RF connector, SMA female, field replaceable. These pins are DC coupled and matched to 50 Ohms. DC blocking capacitors are required if external RF line potential is not equal to 0V.	
4	GND	Power supply ground.	
5	Vctl	CMOS interface, control voltages per table. Requires active pullup to +5V (V <sub>dc</sub> ).	
6	Vdc	Supply voltage	

## GaAs MMIC SPDT NON-REFLECTIVE SWITCH, DC - 20 GHz



### Outline Drawing

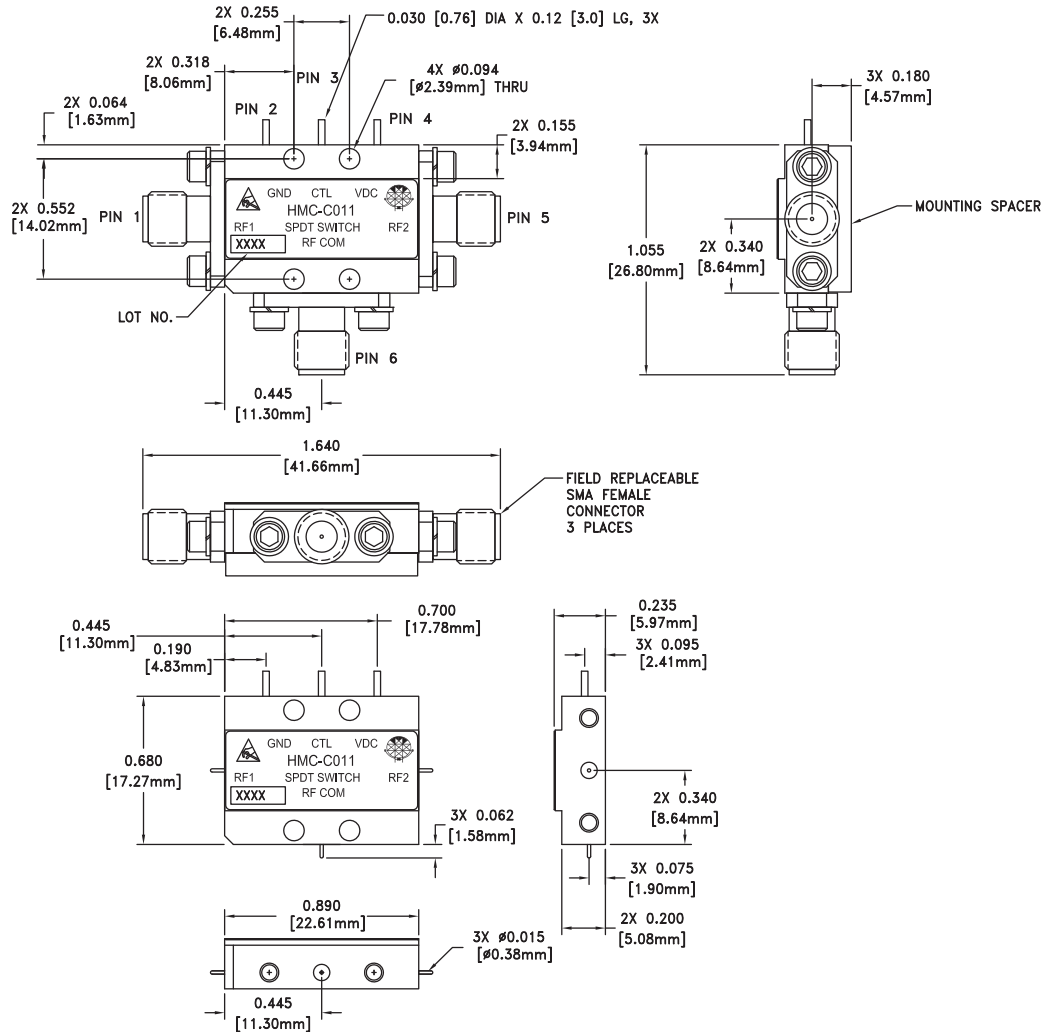

VIEW SHOWN WITH CONNECTORS REMOVED

### Package Information

Package Type	C-5
Package Weight [1]	17.7 gms [2]
Spacer Weight	2.6 gms [2]

[1] Includes the connectors

[2]  $\pm$ 1 gms Tolerance

### NOTES:

1. PACKAGE, LEADS, COVER MATERIAL: KOVAR™
2. FINISH: GOLD PLATE OVER NICKEL PLATE
3. MOUNTING SPACER: NICKEL PLATED ALUMINUM
4. ALL DIMENSIONS ARE IN INCHES [MILLIMETERS]
5. TOLERANCES:
  - 5.1 .XX =  $\pm$ 0.02
  - 5.2 .XXX =  $\pm$ 0.010
6. FIELD REPLACEABLE SMA CONNECTORS  
TENSOLITE 5602 - 5CCSF OR EQUIVALENT
7. TO MOUNT MODULE TO SYSTEM PLATFORM REPLACE 0 -80  
HARDWARE WITH DESIRED MOUNTING SCREWS