

4

3

2

1

THIS DRAWING IS UNPUBLISHED. RELEASED FOR PUBLICATION 2009
 © COPYRIGHT 2009 BY TYCO ELECTRONICS CORPORATION. ALL RIGHTS RESERVED.

LOC	DIST	REVISIONS			
P	LTR	DESCRIPTION	DATE	DWN	APVD
E	B	BA	NEW RELEASE	05-OCT-09	MRS St.P

FOR FURTHER INFORMATION SEE DATA SHEET FOR
 SERIES LR, METAL FILM FIXED RESISTORS

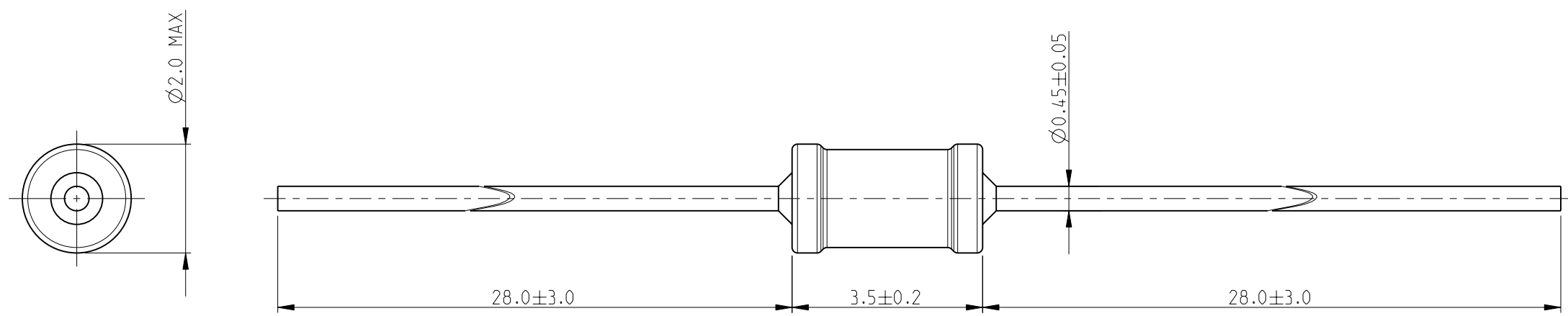

RoHS Compliant

<small>THIS DRAWING IS A CONTROLLED DOCUMENT FOR TYCO ELECTRONICS CORPORATION IT IS SUBJECT TO CHANGE AND THE CONTROLLING ENGINEERING ORGANIZATION SHOULD BE CONTACTED FOR THE LATEST REVISION.</small>		DWN MAHARUDRA 05-OCT-09 CHK ALLAN.P 05-OCT-09 APVD STEPHEN.P 05-OCT-09	Tyco Electronics Corporation Dorcan, Swindon, SN3 5HH
DIMENSIONS: mm	TOLERANCES UNLESS OTHERWISE SPECIFIED: 0 PLC ± 0.2 1 PLC ± 0.1 2 PLC ± - 3 PLC ± - 4 PLC ± - ANGLES ± 5°	PRODUCT SPEC - APPLICATION SPEC - WEIGHT -	NAME METAL FILM FIXED RESISTORS SERIES LR0204
MATERIAL -	FINISH -	SIZE A3 CAGE CODE 00779 DRAWING NO C-1622246	RESTRICTED TO -
CUSTOMER DRAWING		SCALE 10:1	SHEET 1 OF 1 REV BA