

FEATURES

- Dual Time Adjust Repeat Cycle Timer
- 2 Timing modes: 1 On Time first (On/Off Delay)
2 Off Time first (Off/On Delay)
- Timing mode choice by an external jumper
- Time range 0.1 second – 100 days. 10 time ranges available
- Time adjustments by rotary switches and potentiometer
- Relay output form: SPDT – 16 Amps
- Output indicator: red LED
- DIN rail mounting
- UL and CE approvals, RoHS compliant

TIMING MODE

REPEAT CYCLE also called Recycle Timer, Recycling Timer, Flasher

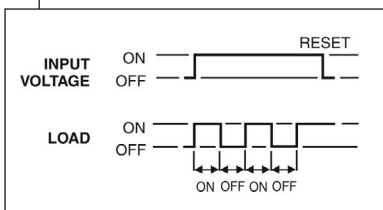

Repeat Cycle On/Off Delay
Application of power to the input voltage terminals starts the "On" delay cycle. At the end of the "On" delay period, the load is de-energized and the "Off" delay starts. At the end of the "Off" cycle the load is energized, the timer

returns to the "On" cycle and the cycling is repeated as long as input voltage is applied. Removal of input voltage will reset the timer to its pre-power condition.

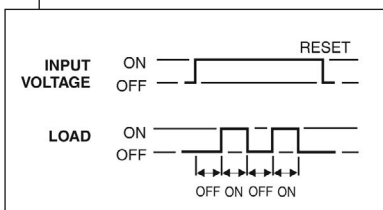

Repeat Cycle Off/On Delay
Application of power to the input voltage terminals starts the "Off" delay cycle. At the end of the "Off" delay period, the load is energized and the "On" delay starts. At the end of the "On" cycle, the load is de-energized, the timer returns to

the "Off" cycle and the cycling is repeated as long as input voltage is applied. Removal of input voltage will reset the timer to its pre-power condition.



102

**DUAL
TIME ADJUST
REPEAT CYCLE
TIMER**

10/09/15

SPECIFICATIONS

- Number of timing modes** . . . 2
- Input terminals** A1-A2
- Input voltage** AC/DC 12–240V (AC 50/60Hz)
- Power consumption** 3 watts max
- Input voltage tolerance** . . . -15% to +10%
- Input indicator** Green LED
- Time ranges** 0.1 second–100 days
- Time settings by** Rotary switch and potentiometer
- Setting accuracy** 5%
- Repeatability** 0.2%
- Relay output form** SPDT
- Rated current** 16A/ AC
- Switching capacity** 4000 VA/ AC, 384 W/ DC
- Inrush current** 30A / < 3s
- Switching voltage (max)** . . . 250VAC / 24VDC
- Switching capacity DC (min)** 500mW
- Output indicator** Multifunction red LED
- Mechanical life** 30 million operations
- Electrical life (resistive)** . . . 70,000 operations
- Reset time (max)** 150ms
- Operating temperature** . . . -20°C to +55°C
- Storage temperature** -30°C to +70°C
- Dielectric strength** 4 kV
- Operating position** any
- Mounting** DIN rail EN 60715
- Protection degree** IP 40 from front panel
- Wire size (max)** 14AWG
- Standards** EN 61812-1, EN 61010-1, UL, CE, RoHS

FEATURES

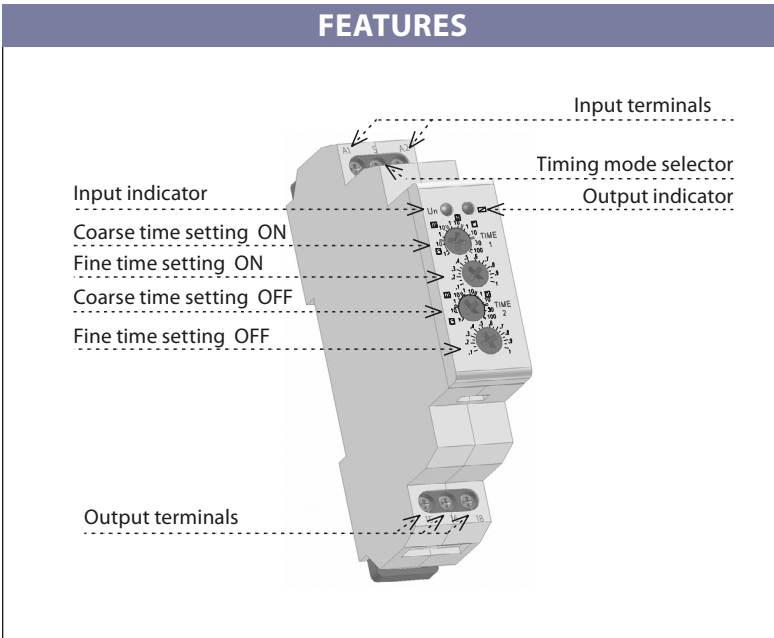



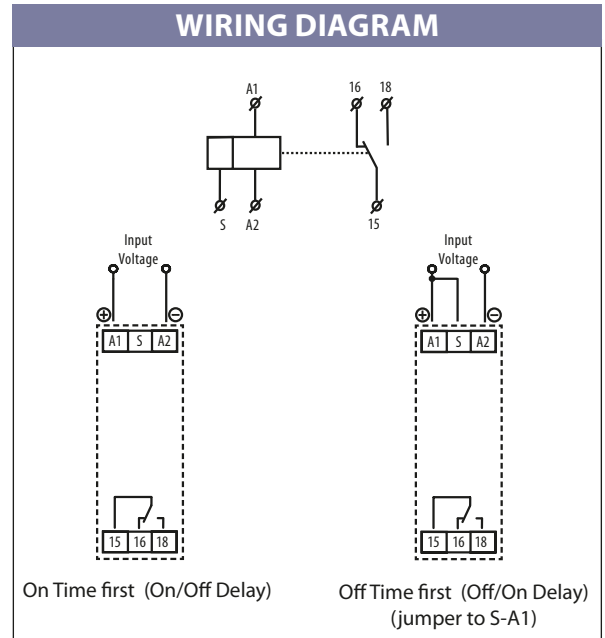



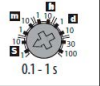

WIRING DIAGRAM

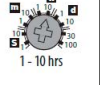

10/09/15

TIME RANGE SETTINGS

 0.1 - 1 s	 1 - 10 s	 0.1 - 1 min	 1 - 10 min	 0.1 - 1 h
 1 - 10 hrs	 0.1 - 1 day	 1 - 10 days	 3 - 30 days	 10 - 100 days