

DESCRIPTION

Demonstration circuit 833 is an ultra-low dropout voltage supply using the LTC3026 linear regulator, which comes in a small 3mm x 3mm 10-Pin DFN package. The DC833 has an input voltage range from 1.14V to 3.5V when the internal boost converter is enabled, and a maximum input voltage of 5.5V when an external source is supplied. The output voltage range is between 0.4V and 2.6V, and it is capable of delivering 1.5A max. output current. The 0.4V reference of the LTC3026 allows DC833 to supply power to very low voltage applications. The

DC833 is also an excellent choice for post regulation of step-down switching regulators, creating a high efficiency low-noise supply. DC833 comes assembled with small ceramic capacitors, showing the LTC3026 ability to maintain stability with ceramic output capacitors.

Gerber files for this circuit are available. Call the LTC Factory.

 , LTC and LT are registered trademarks of Linear Technology Corporation.

QUICK START PROCEDURE

The DC833 is easy to set up to evaluate the performance of the LTC3026. For proper measurement equipment configuration, set up the circuit according to the diagram in Figure 1.

Please follow the procedure outlined below for proper operation.

1. Before proceeding to test, insert jumper JP5 shunt into the OFF position, insert jumper JP6 into the EXT(ernal) position, and insert a shunt into jumper JP1 for 1.2V output.
2. Apply 1.4V to Vin, and 5V to Vboost.

Note: The bias voltage, Vboost, must be between 4.5V and 5.5V for correct output regulation.

Insert jumper JP5 shunt into the ON position. Measure Vout; it should be 1.2V \pm 2% (1.176V to 1.224V).

3. Vary the input voltage from 1.4V to 5.5V and the load current from no load to 1.5A. Vout should measure 1.2V \pm 2% (1.176V to 1.224V).
4. Insert jumper JP5 into the OFF position and move the shunt from jumper JP1 into any of

the remaining output voltage options: 0.8V, 1.5V, or 1.8V. Move the shunt in JP6 from the EXT(ernal) position to the Boost (Regulator) position (Remove the ext. 5V bias voltage). Re-insert jumper JP5 shunt into the ON position. Just as in the 1.2Vout test, the output voltage should read Vout \pm 2% tolerance under static line and load conditions, and \pm 2% tolerance under dynamic line and load conditions.

5. When finished evaluating, insert jumper JP5 into the OFF position.

Note - If the power for the demo board is carried in long leads, the input voltage at the part could “ring”, due to the inductance in the long leads. This ringing could affect the operation of the circuit or even exceed the maximum voltage rating of the IC. To eliminate the ringing, a small tantalum capacitor (for instance, an AVX part # TAJW686M010R) was inserted on the pads between the input power and return terminals on the bottom of the demo board. The (greater) ESR of the tantalum will dampen the (possible) ringing voltage due to the use of long input leads. On a normal, typical PCB, with short traces, the capacitor is not needed.

QUICK START GUIDE FOR DEMONSTRATION CIRCUIT 833

VLDO LOW NOISE LINEAR REGULATOR

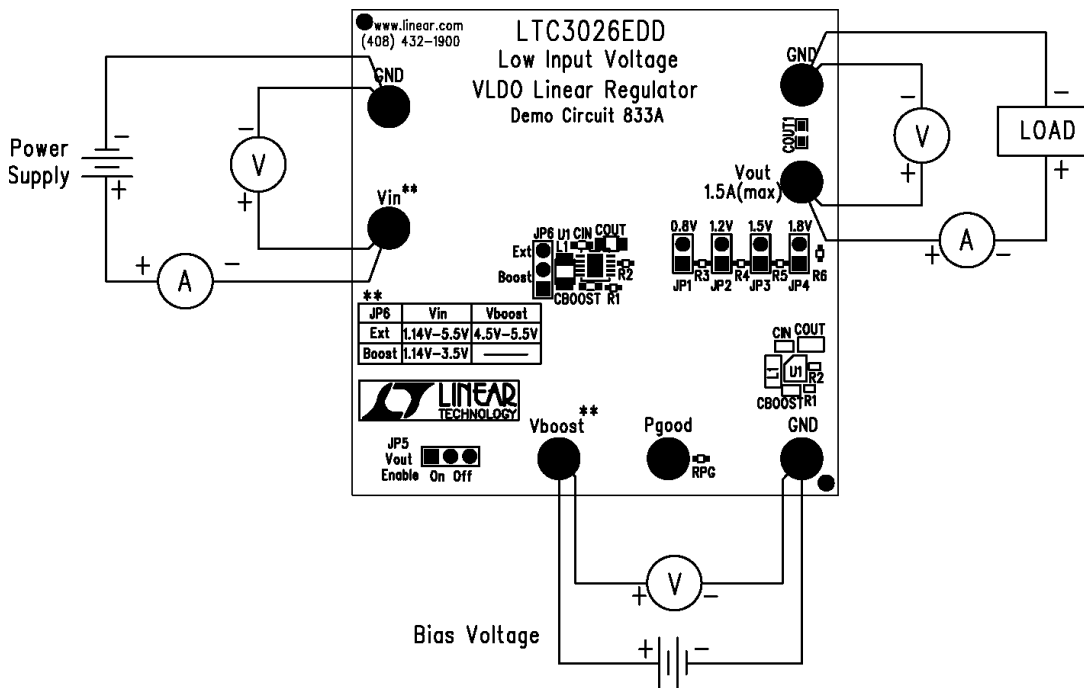

VBOOST must be between 4.5V and 5.5V for proper operation.

Figure1. Proper Measurement Equipment Setup

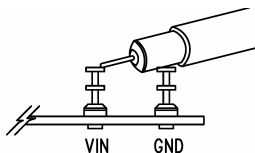
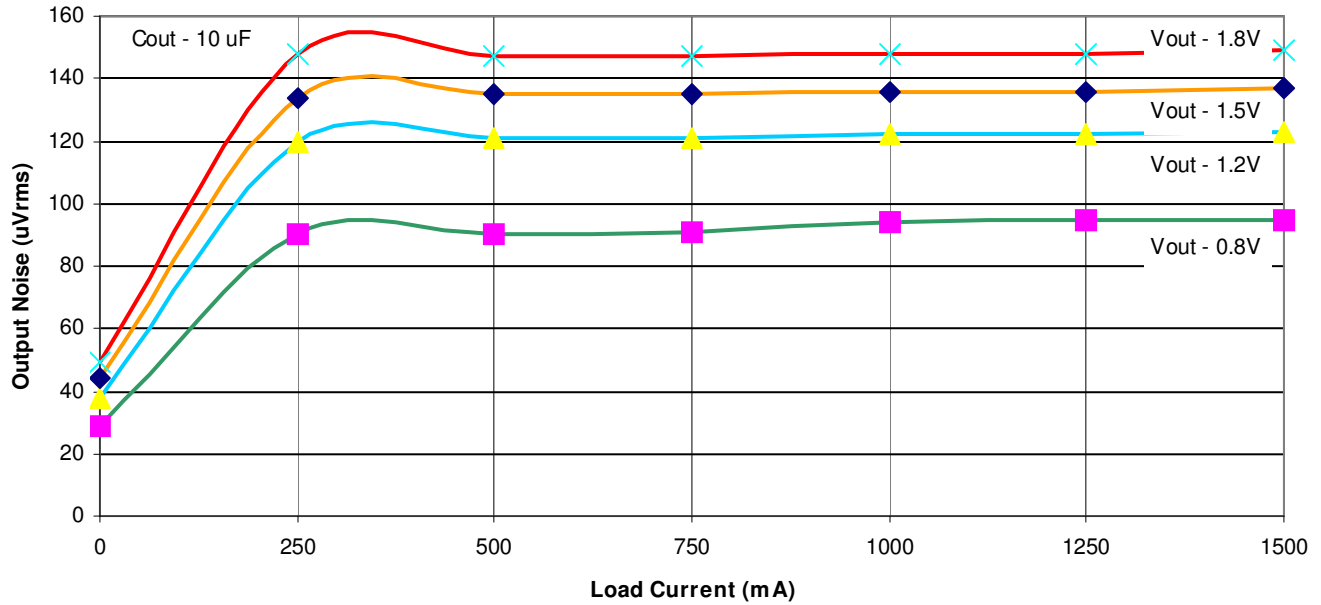

Figure 2. Measuring Input or Output Ripple

QUICK START GUIDE FOR DEMONSTRATION CIRCUIT 833

VLDO LOW NOISE LINEAR REGULATOR

RMS Output Noise vs. Load Current
(10 Hz to 100 kHz)



QUICK START GUIDE FOR DEMONSTRATION CIRCUIT 833

VLDO LOW NOISE LINEAR REGULATOR

Output Noise Spectral Density

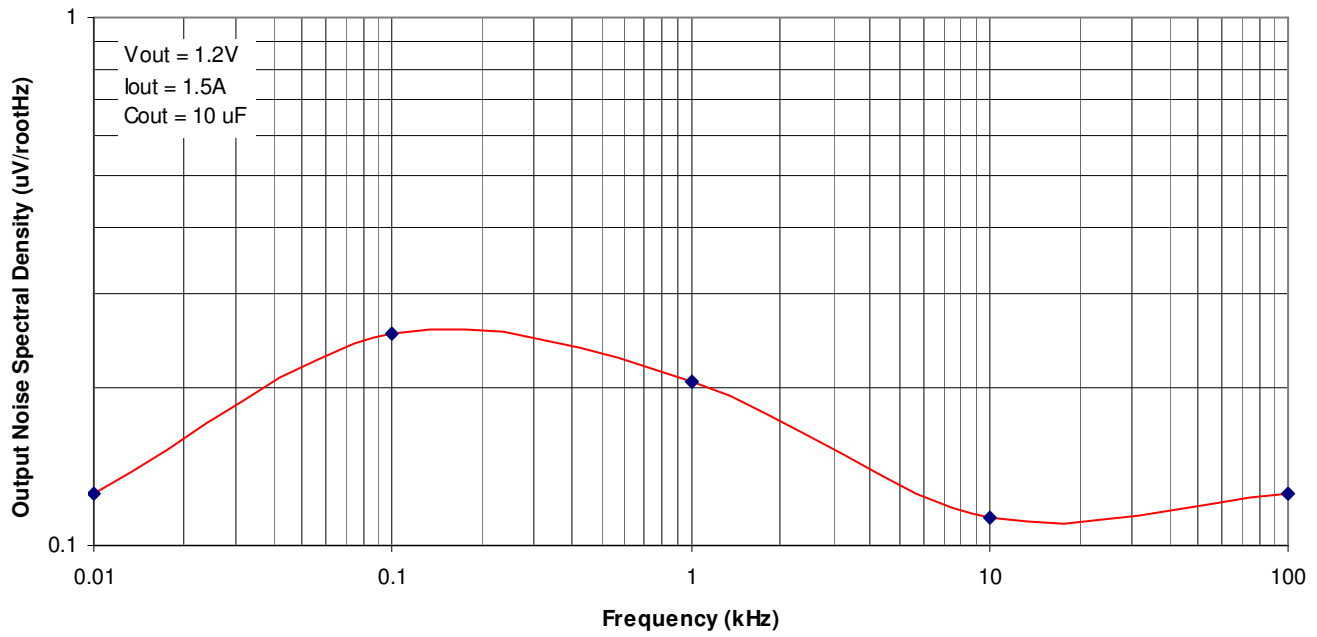

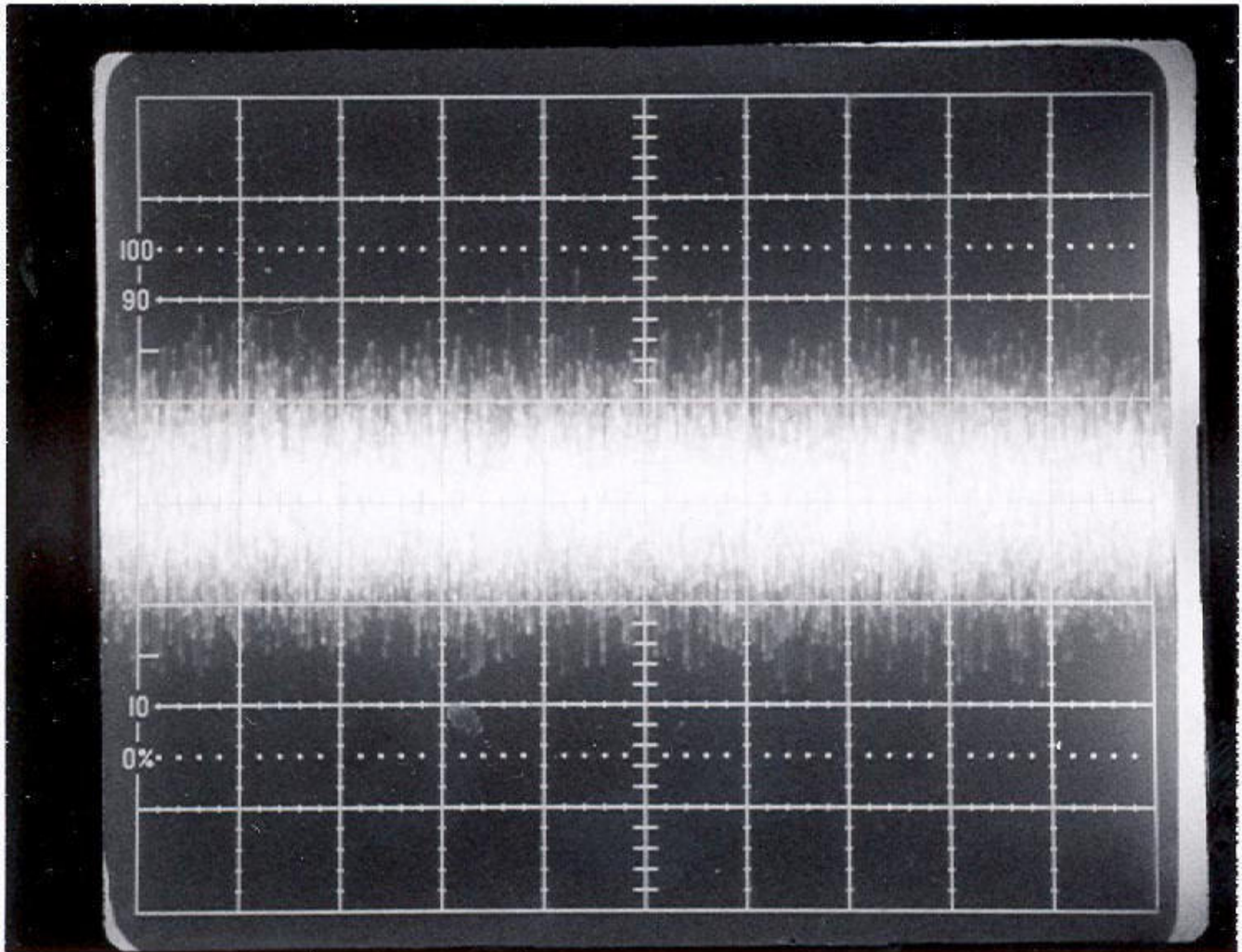

10 Hz to 100 kHz Output Noise (X-Axis Scale: 1ms/div; Y-Axis Scale: 200uV/div)

Vout = 1.2V Vboost = 5V Iout = 1.5A

QUICK START GUIDE FOR DEMONSTRATION CIRCUIT 833

VLDO LOW NOISE LINEAR REGULATOR

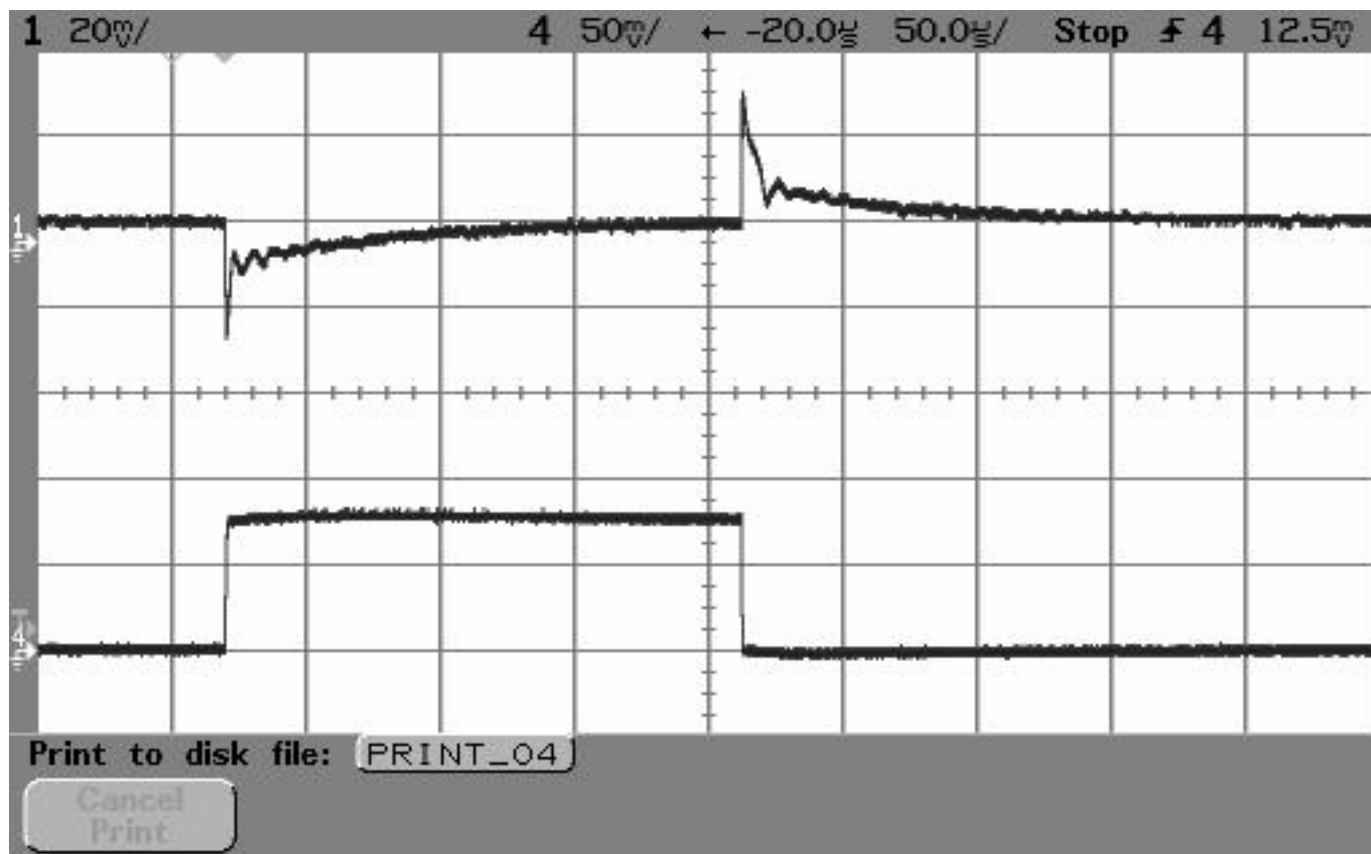

LTC3025 Load-Step Response – Trace 1: Vout Ripple (20 mV/div) – Trace 2: Iout (1A/div)

Vin = 2V Vout = 1.2V Vboost = 5V Istep = 1.5A Iout(min) = 20 mA
Cout = 10 uF Time Base: 50 us/div

QUICK START GUIDE FOR DEMONSTRATION CIRCUIT 833

VLDO LOW NOISE LINEAR REGULATOR

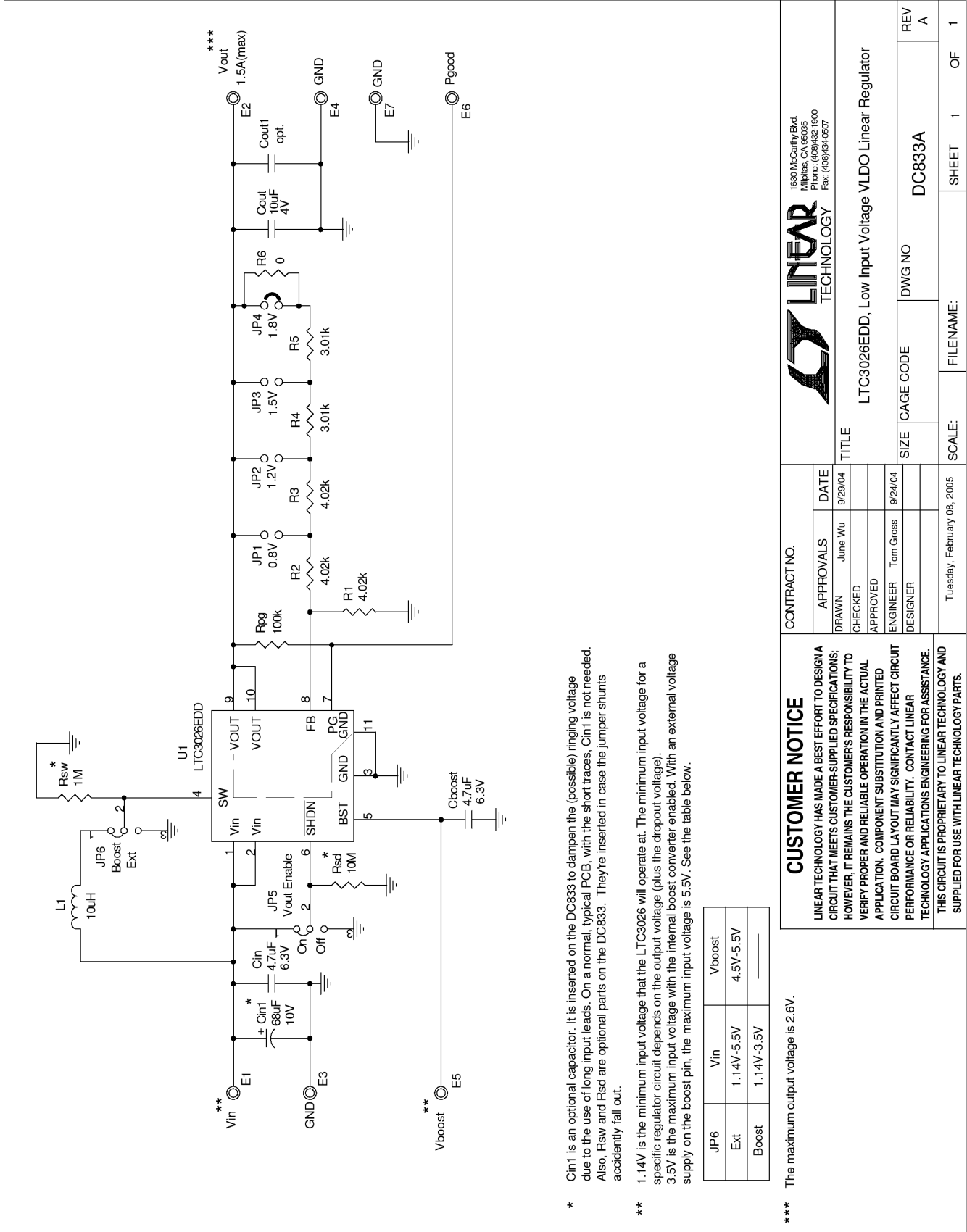

CONTRACT NO.

APPROVALS	DATE
DRAWN June Wu	9/29/04
CHECKED	
APPROVED	
ENGINEER Tom Gross	9/24/04
DESIGNER	

Tuesday, February 08, 2005

LINEAR TECHNOLOGY

1630 McCaffery Blvd.
Milpitas, CA 95035
Phone: (408)432-1900
Fax: (408)434-6507

CUSTOMER NOTICE

LINEAR TECHNOLOGY HAS MADE A BEST EFFORT TO DESIGN A CIRCUIT THAT MEETS CUSTOMER-SUPPLIED SPECIFICATIONS; HOWEVER, IT REMAINS THE CUSTOMER'S RESPONSIBILITY TO VERIFY PROPER AND RELIABLE OPERATION IN THE ACTUAL APPLICATION. COMPONENT SUBSTITUTION AND PRINTED CIRCUIT BOARD LAYOUT MAY SIGNIFICANTLY AFFECT CIRCUIT PERFORMANCE OR RELIABILITY. CONTACT LINEAR TECHNOLOGY APPLICATIONS ENGINEERING FOR ASSISTANCE.

THIS CIRCUIT IS PROPRIETARY TO LINEAR TECHNOLOGY AND SUPPLIED FOR USE WITH LINEAR TECHNOLOGY PARTS.

TITLE

LTC3026EDD, Low Input Voltage VLDO Linear Regulator

SIZE CAGE CODE **DWG NO** DC8333A **REV** A

SCALE: FILENAME: SHEET 1 OF 1