

3.3 V/5 V Logic Gate Output Optocoupler with High Noise Immunity

FODM8071

Description

The FODM8071 is a 3.3 V/5 V high-speed logic gate output optocoupler, which supports isolated communications allowing digital signals to communicate between systems without conducting ground loops or hazardous voltages. It utilizes onsemi's patented coplanar packaging technology, OPTOPLANAR[®], and optimized IC design to achieve high-immunity, characterized by high common mode rejection specifications.

This high-speed logic gate output optocoupler, housed in a compact 5-pin Mini-Flat package, consists of a highspeed AlGaAs LED at the input coupled to a CMOS detector IC at the output. The detector IC comprises an integrated photodiode, a high-speed transimpedance amplifier and a voltage comparator with an output driver. The CMOS technology coupled with a high-efficiency LED achieves low power consumption as well as very high speed (55 ns propagation delay, 20 ns pulse width distortion).

Features

- High-noise Immunity Characterized by Common Mode Rejection
 - ◆ 20 kV/μs Minimum Common Mode Rejection
- High Speed
 - ◆ 20 Mbit/s Data Rate (NRZ)
 - ◆ 55 ns Maximum Propagation Delay
 - ◆ 20 ns Maximum Pulse Width Distortion
 - ◆ 30 ns Maximum Propagation Delay Skew
- 3.3 V and 5 V CMOS Compatibility
- Specifications Guaranteed Over 3 V to 5.5 V Supply Voltage and -40°C to +110°C Temperature Range
- Safety and Regulatory Approvals:
 - ◆ UL1577, 3750 VAC_{RMS} for 1 Minute
 - ◆ DIN EN/IEC60747-5-5
- These are Pb-Free Devices

Applications

- Microprocessor System Interface:
 - SPI, I²C
- Industrial Fieldbus Communications:
 - DeviceNet, CAN, RS485
- Programmable Logic Control
- Isolated Data Acquisition System
- Voltage Level Translator

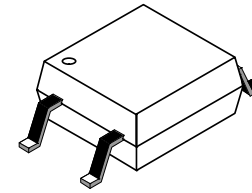

MFP5 4.1 x 4.4, 2.54P
CASE 100AM

MARKING DIAGRAM

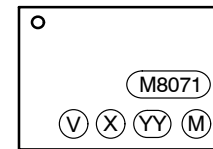

- M8071 = Device Number
- V = DIN EN/IEC60747-5-5 Option
(Note: Only Appears on Parts Ordered with This Option)
- X = One Digit Year Code, e.g., '4'
- YY = Two Digit Work Week,
Ranging from '01' to '53'
- M = Assembly Package Code

PIN CONNECTIONS

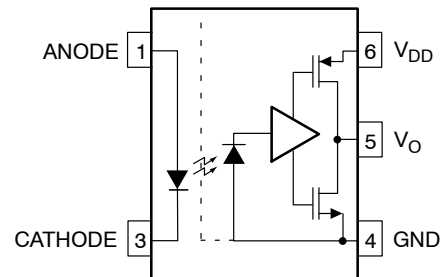

Figure 1. PIN CONNECTION

TRUTH TABLE

| LED | Output |
|-----|--------|
| Off | High |
| On | Low |

RELATED RESOURCES

- [FOD8001 Product Folder](#)
- [FOD0721 Product Folder](#)

ORDERING INFORMATION

See detailed ordering and shipping information on page 9 of this data sheet.

FODM8071

SAFETY AND INSULATION RATINGS (As per DIN EN/IEC 60747-5-5, this optocoupler is suitable for “safe electrical insulation” only within the safety limit data. Compliance with the safety ratings shall be ensured by means of protective circuits.)

| Parameter | | Characteristics |
|---|------------------------|-----------------|
| Installation Classifications per DIN VDE 0110/1.89 Table 1, For Rated Mains Voltage | < 150 V _{RMS} | I-IV |
| | < 300 V _{RMS} | I-III |
| Climatic Classification | | 40/110/21 |
| Pollution Degree (DIN VDE 0110/1.89) | | 2 |
| Comparative Tracking Index | | 175 |

| Symbol | Parameter | Value | Unit |
|-----------------------|--|-------------------|-------------------|
| V _{PR} | Input-to-Output Test Voltage, Method A, V _{IORM} × 1.6 = V _{PR} , Type and Sample Test with t _m = 10 s, Partial Discharge < 5 pC | 904 | V _{peak} |
| | Input-to-Output Test Voltage, Method B, V _{IORM} × 1.875 = V _{PR} , 100% Production Test with t _m = 1 s, Partial Discharge < 5 pC | 1060 | V _{peak} |
| V _{IORM} | Maximum Working Insulation Voltage | 565 | V _{peak} |
| V _{IOTM} | Highest Allowable Over-Voltage | 4000 | V _{peak} |
| | External Creepage | ≥ 5 | mm |
| | External Clearance | ≥ 5 | mm |
| DTI | Distance Through Insulation (Insulation Thickness) | ≥ 0.4 | mm |
| T _S | Case Temperature (Note 1) | 150 | °C |
| I _{S,INPUT} | Input Current (Note 1) | 200 | mA |
| P _{S,OUTPUT} | Output Power (Note 1) | 300 | mW |
| R _{IO} | Insulation Resistance at T _S , V _{IO} = 500 V (Note 1) | > 10 ⁹ | Ω |

1. Safety limit values – maximum values allowed in the event of a failure.

PIN DEFINITIONS

| Number | Name | Function Description |
|--------|-----------------|-----------------------|
| 1 | ANODE | Anode |
| 3 | CATHODE | Cathode |
| 4 | GND | Output Ground |
| 5 | V _O | Output Voltage |
| 6 | V _{DD} | Output Supply Voltage |

FODM8071

ABSOLUTE MAXIMUM RATINGS (T_A = 25°C, unless otherwise noted)

| Symbol | Parameter | Value | Unit |
|------------------|---|-------------------------------|------|
| T _{STG} | Storage Temperature | -40 to +125 | °C |
| T _{OPR} | Operating Temperature | -40 to +110 | °C |
| T _J | Junction Temperature | -40 to +125 | °C |
| T _{SOL} | Lead Solder Temperature (Refer to Reflow Temperature Profile) | 260 for 10 s | °C |
| I _F | Forward Current | 20 | mA |
| V _R | Reverse Voltage | 5 | V |
| V _{DD} | Supply Voltage | 0 to 6.0 | V |
| V _O | Output Voltage | -0.5 to V _{DD} + 0.5 | V |
| I _O | Average Output Current | 10 | mA |
| PD _I | Input Power Dissipation (Note 2, 4) | 40 | mW |
| PD _O | Output Power Dissipation (Note 3, 4) | 70 | mW |

Stresses exceeding those listed in the Maximum Ratings table may damage the device. If any of these limits are exceeded, device functionality should not be assumed, damage may occur and reliability may be affected.

2. Derate linearly from 95°C at a rate of -1.4 mW/°C.

3. Derate linearly from 100°C at a rate of -3.47 mW/°C.

4. Functional operation under these conditions is not implied. Permanent damage may occur if the device is subjected to conditions outside these ratings.

RECOMMENDED OPERATING CONDITIONS

| Symbol | Parameter | Min | Max | Unit |
|-----------------|-------------------------------|-----|------|------|
| T _A | Ambient Operating Temperature | -40 | +110 | °C |
| V _{DD} | Supply Voltages (Note 5) | 3.0 | 5.5 | V |
| V _{FL} | Logic Low Input Voltages | 0 | 0.8 | V |
| I _{FH} | Logic High Input Current | 5 | 16 | mA |
| I _{OL} | Logic Low Output Current | 0 | 7 | mA |

Functional operation above the stresses listed in the Recommended Operating Ranges is not implied. Extended exposure to stresses beyond the Recommended Operating Ranges limits may affect device reliability.

5. 0.1 µF bypass capacitor must be connected between 4 and 6.

FODM8071

ELECTRICAL CHARACTERISTICS Apply over all recommended conditions ($T_A = -40^{\circ}\text{C}$ to $+110^{\circ}\text{C}$, $3.0\text{ V} \leq V_{DD} \leq 5.5\text{ V}$ unless otherwise specified.) All typical values are measured at $T_A = 25^{\circ}\text{C}$ and $V_{DD} = 3.3\text{ V}$.

| Symbol | Parameter | Test Conditions | Min | Typ | Max | Unit |
|-------------------------------|----------------------------------|--|-----------------------|--------|------|------|
| INPUT CHARACTERISTICS | | | | | | |
| V_F | Forward Voltage | $I_F = 10\text{ mA}$ (Figure 2) | 1.05 | 1.35 | 1.80 | V |
| BV_R | Input Reverse Breakdown Voltage | $I_R = 10\text{ }\mu\text{A}$ | 5 | 15 | – | V |
| I_{FHL} | Threshold Input Current | (Figure 3) | – | 2.8 | 5.0 | mA |
| OUTPUT CHARACTERISTICS | | | | | | |
| I_{DDL} | Logic Low Output Supply Current | $V_{DD} = 3.3\text{ V}$, $I_F = 10\text{ mA}$ (Figures 4 and 6) | – | 3.3 | 4.8 | mA |
| | | $V_{DD} = 5.0\text{ V}$, $I_F = 10\text{ mA}$ (Figures 4 and 7) | – | 4.0 | 5.0 | mA |
| I_{DDH} | Logic High Output Supply Current | $V_{DD} = 3.3\text{ V}$, $I_F = 0\text{ mA}$ (Figure 5) | – | 3.3 | 4.8 | mA |
| | | $V_{DD} = 5.0\text{ V}$, $I_F = 0\text{ mA}$ (Figure 5) | – | 4.0 | 5.0 | mA |
| V_{OH} | Logic High Output Voltage | $V_{DD} = 3.3\text{ V}$, $I_O = -20\text{ }\mu\text{A}$, $I_F = 0\text{ mA}$ | $V_{DD}-0.1\text{ V}$ | 3.3 | – | V |
| | | $V_{DD} = 3.3\text{ V}$, $I_O = -4\text{ mA}$, $I_F = 0\text{ mA}$ | $V_{DD}-0.5\text{ V}$ | 3.1 | – | V |
| | | $V_{DD} = 5.0\text{ V}$, $I_O = -20\text{ }\mu\text{A}$, $I_F = 0\text{ mA}$ | $V_{DD}-0.1\text{ V}$ | 5.0 | – | V |
| | | $V_{DD} = 5.0\text{ V}$, $I_O = -4\text{ mA}$, $I_F = 0\text{ mA}$ | $V_{DD}-0.5\text{ V}$ | 4.9 | – | V |
| V_{OL} | Logic Low Output Voltage | $I_O = 20\text{ }\mu\text{A}$, $I_F = 10\text{ mA}$ | – | 0.0027 | 0.01 | V |
| | | $I_O = 4\text{ mA}$, $I_F = 10\text{ mA}$ | – | 0.27 | 0.80 | V |

Product parametric performance is indicated in the Electrical Characteristics for the listed test conditions, unless otherwise noted. Product performance may not be indicated by the Electrical Characteristics if operated under different conditions.

FODM8071

SWITCHING CHARACTERISTICS Apply over all recommended conditions ($T_A = -40^{\circ}\text{C}$ to $+110^{\circ}\text{C}$, $3.0\text{ V} \leq V_{DD} \leq 5.5\text{ V}$ unless otherwise specified.) All typical values are measured at $T_A = 25^{\circ}\text{C}$ and $V_{DD} = 3.3\text{ V}$.

| Symbol | Parameter | Test Conditions | Min | Typ | Max | Unit |
|--------------------|---|---|-----|-----|-----|-------------------|
| Date Rate (Note 6) | | | - | - | 20 | Mbps |
| t_{PW} | Pulse Width | | 50 | - | - | ns |
| t_{PHL} | Propagation Delay Time to Logic Low Output | $C_L = 15\text{ pF}$ (Figure 8, 9 and 13) | - | 31 | 55 | ns |
| t_{PLH} | Propagation Delay Time to Logic High Output | $C_L = 15\text{ pF}$ (Figure 8, 9 and 13) | - | 25 | 55 | ns |
| PWD | Pulse Width Distortion, $ t_{PHL} - t_{PLH} $ | $C_L = 15\text{ pF}$ (Figure 10 and 11) | - | 5.5 | 20 | ns |
| t_{PSK} | Propagation Delay Skew | $C_L = 15\text{ pF}$ (Note 7) | - | - | 30 | ns |
| t_R | Output Rise Time (10% to 90%) | (Figure 12 and 13) | - | 5.8 | - | ns |
| t_F | Output Fall Time (90% to 10%) | (Figure 12 and 13) | - | 5.3 | - | ns |
| $ CM_H $ | Common Mode Transient Immunity at Output High | $I_F = 0\text{ mA}$, $V_O > 0.8 V_{DD}$, $V_{CM} = 1000\text{ V}$, $T_A = 25^{\circ}\text{C}$ (Figure 14) (Note 8) | 20 | 40 | - | kV/ μs |
| $ CM_L $ | Common Mode Transient Immunity at Output Low | $I_F = 5\text{ mA}$, $V_O < 0.8\text{ V}$, $V_{CM} = 1000\text{ V}$, $T_A = 25^{\circ}\text{C}$ (Figure 14) (Note 8) | 20 | 40 | - | kV/ μs |
| C_{PDO} | Output Dynamic Power Dissipation Capacitance (Note 9) | | - | 4 | - | pF |

- Data rate is based on 10 MHz, 50% NRZ pattern with a 50 ns minimum bit time.
- t_{PSK} is equal to the magnitude of the worst case difference in t_{PHL} and/or t_{PLH} that will be seen between any two units from the same manufacturing date code that are operated at same case temperature ($\pm 5^{\circ}\text{C}$), at the same operating conditions, with equal loads ($R_L = 350\ \Omega$ and $C_L = 15\text{ pF}$), and with an input rise time less than 5 ns.
- Common mode transient immunity at output high is the maximum tolerable positive dV_{cm}/dt on the leading edge of the common mode impulse signal, V_{cm} , to assure that the output will remain high. Common mode transient immunity at output low is the maximum tolerable negative dV_{cm}/dt on the trailing edge of the common pulse signal, V_{cm} , to assure that the output will remain low.
- Unloaded dynamic power dissipation is calculated as follows: $C_{PD} \times V_{DD} \times f + I_{DD} + V_{PD}$ where f is switched time in MHz.

ISOLATION CHARACTERISTICS

| Symbol | Parameter | Conditions | Min | Typ | Max | Unit |
|-----------|--------------------------------|--|-----------|-----|-----|-------------|
| V_{ISO} | Input-Output Isolation Voltage | $f = 60\text{ Hz}$, $t = 1.0\text{ min.}$, $I_{I-O} \leq 10\ \mu\text{A}$ (Note 10, 11) | 3750 | - | - | V_{ACRMS} |
| R_{ISO} | Isolation Resistance | $V_{I-O} = 500\text{ V}$ (Note 10) | 10^{11} | - | - | Ω |
| C_{ISO} | Isolation Capacitance | $V_{I-O} = 0\text{ V}$, $f = 1.0\text{ Mhz}$ (Note 10) | - | 0.2 | - | pF |

- Device is considered a two terminal device: pins 1 and 3 are shorted together and pins 4, 5 and 6 are shorted together.
- 3,750 V_{ACRMS} for 1 minute duration is equivalent to 4,500 V_{ACRMS} for 1 second duration.

TYPICAL PERFORMANCE CURVES

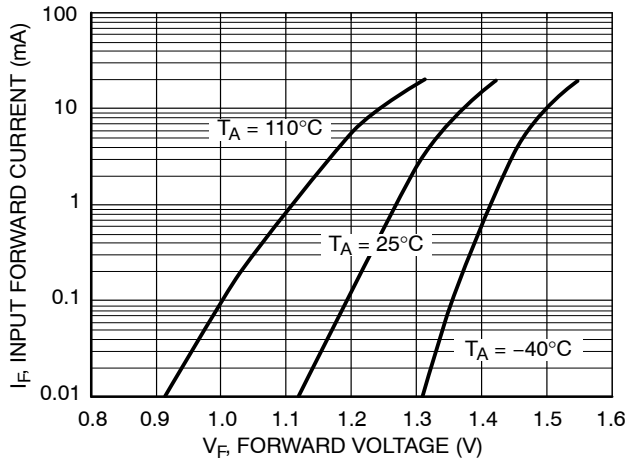

Figure 2. Input Forward Current vs. Forward Voltage

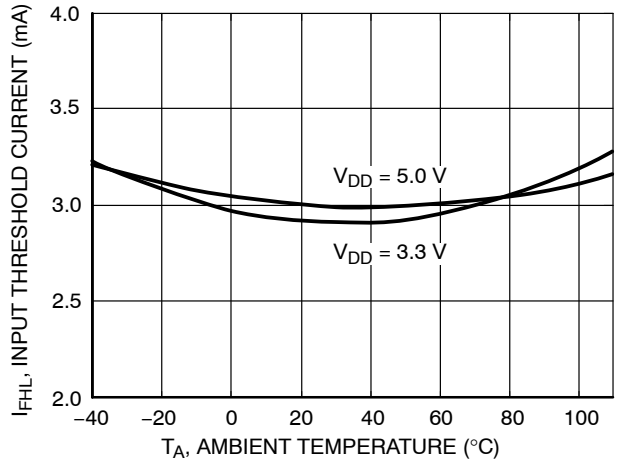

Figure 3. Input Threshold Current vs. Ambient Temperature

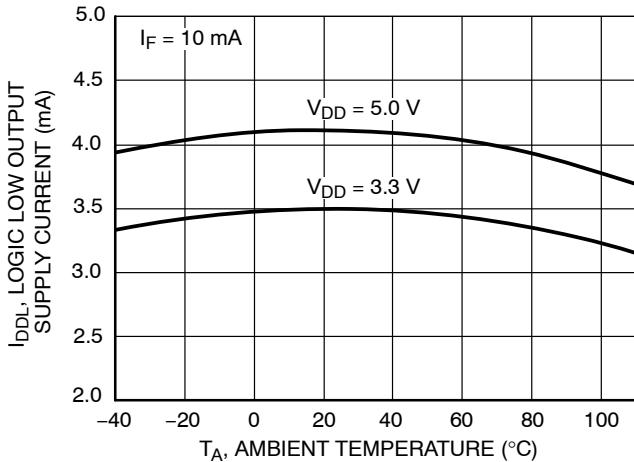

Figure 4. Logic Low Output Supply Current vs. Ambient Temperature

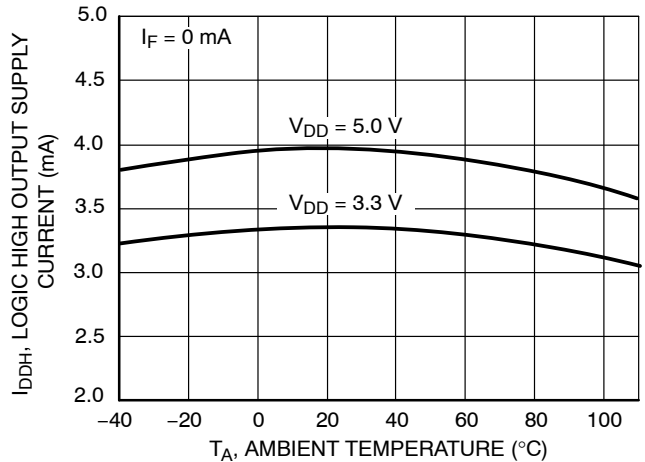

Figure 5. Logic High Output Supply Current vs. Ambient Temperature

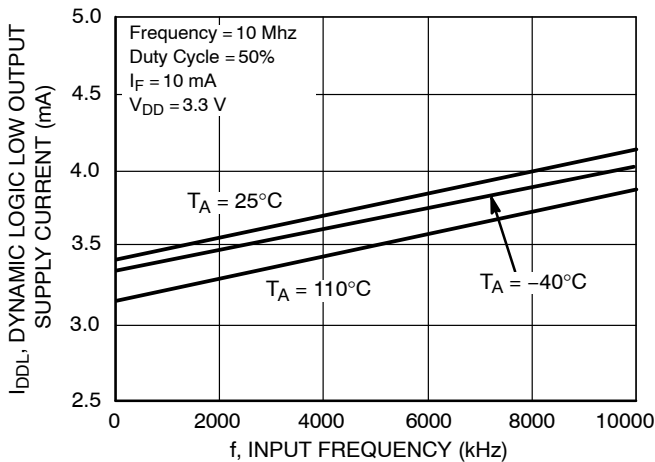

Figure 6. Dynamic Logic Low Output Supply Current vs. Input Frequency ($V_{DD} = 3.3 V$)

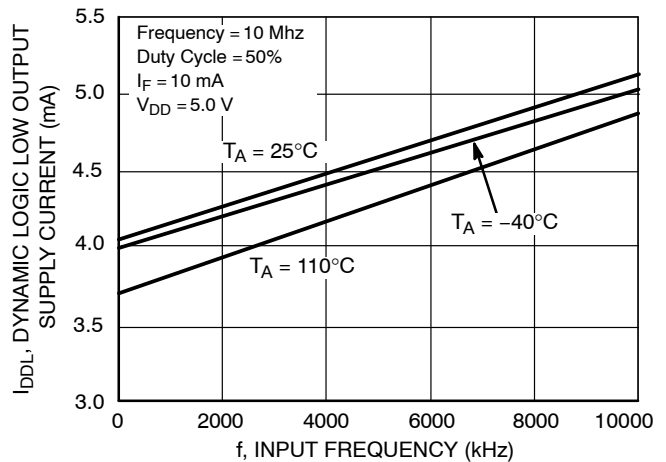

Figure 7. Dynamic Logic Low Output Supply Current vs. Input Frequency ($V_{DD} = 5.0 V$)

TYPICAL PERFORMANCE CURVES

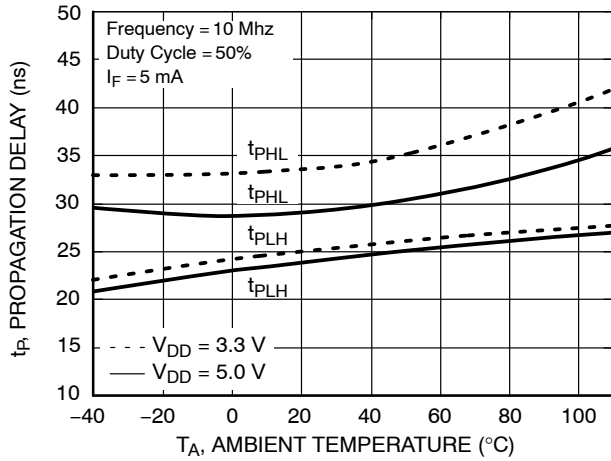

Figure 8. Propagation Delay vs. Ambient Temperature

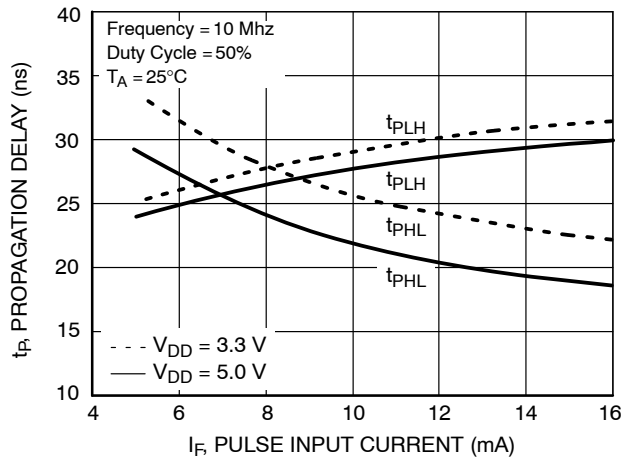

Figure 9. Propagation Delay vs. Pulse Input Current

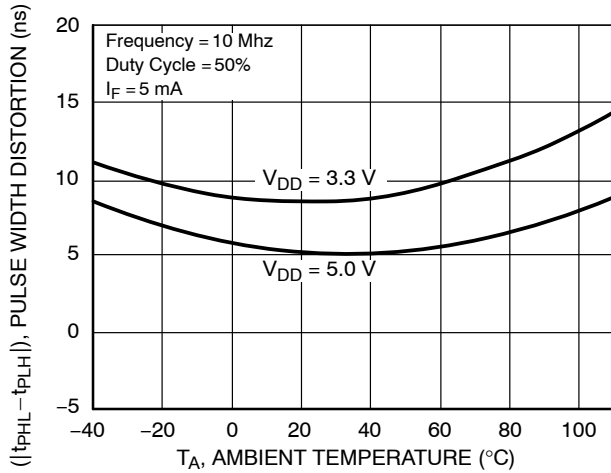

Figure 10. Pulse Width Distortion vs. Ambient Temperature

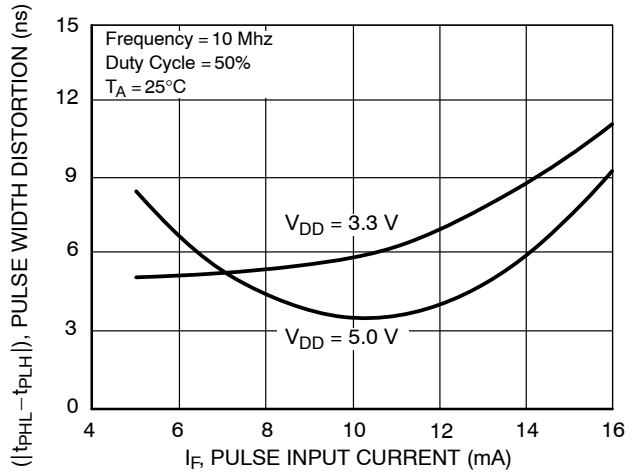

Figure 11. Pulse Width Distortion vs. Pulse Input Current

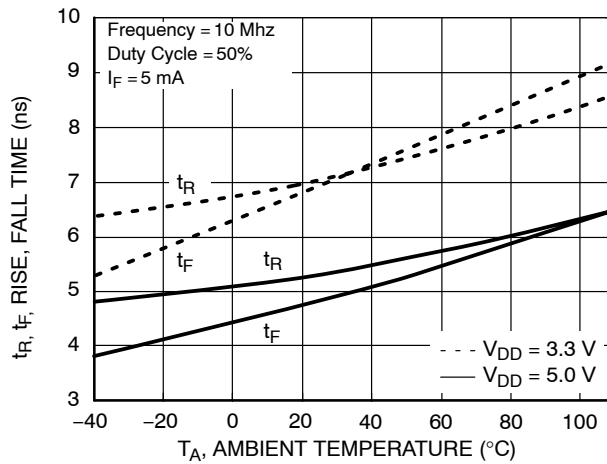

Figure 12. Rise and Fall Time vs. Ambient Temperature

FODM8071

TEST CIRCUITS

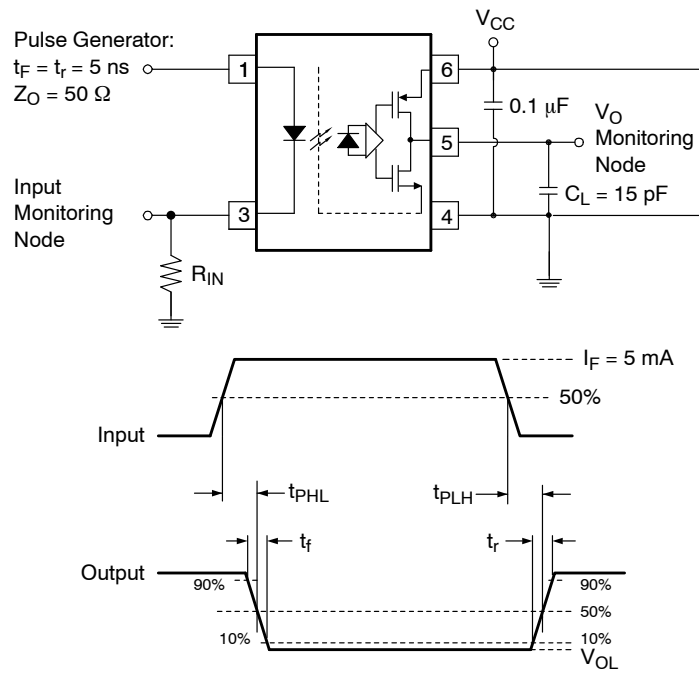

Figure 13. Test Circuit for Propagation Delay, Rise Time, and Fall Time

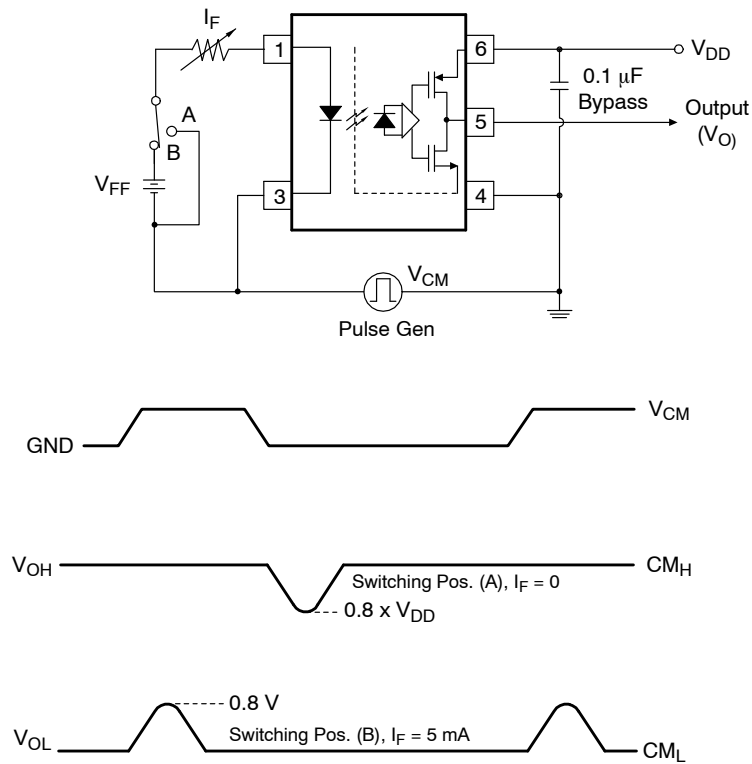

Figure 14. Test Circuit for Instantaneous Common Mode Rejection Voltage

FODM8071

REFLOW PROFILE

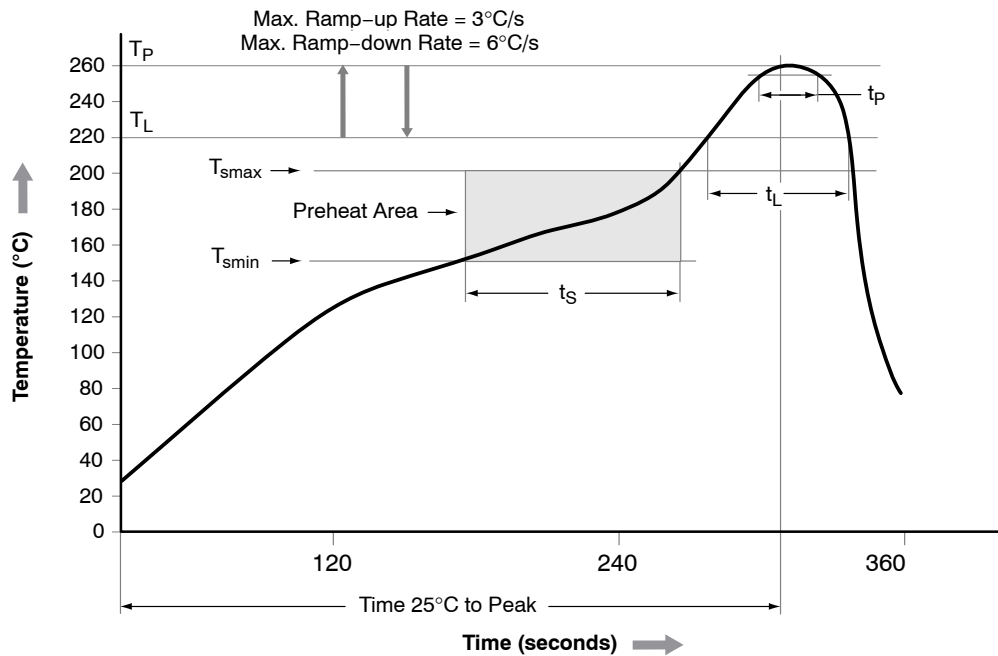

Figure 15. Reflow Profile

Table 1. REFLOW PROFILE

| Profile Feature | Pb-Free Assembly Profile |
|--|--------------------------|
| Temperature Minimum (T_{smin}) | 150°C |
| Temperature Maximum (T_{smax}) | 200°C |
| Time (t_s) from (T_{smin} to T_{smax}) | 60 – 120 seconds |
| Ramp-up Rate (t_L to t_p) | 3°C/second maximum |
| Liquidous Temperature (T_L) | 217°C |
| Time (t_L) Maintained Above (T_L) | 60 – 150 seconds |
| Peak Body Package Temperature | 260°C +0°C / -5°C |
| Time (t_p) within 5°C of 260°C | 30 seconds |
| Ramp-down Rate (T_P to T_L) | 6°C/second maximum |
| Time 25°C to Peak Temperature | 8 minutes maximum |

ORDERING INFORMATION

| Part Number | Package | Shipping [†] |
|-------------|-----------------------------------|-----------------------|
| FODM8071 | Mini-Flat 5-Pin, 4.1 x 4.4, 2.54P | 100 Units / Tube |
| FODM8071R2 | Mini-Flat 5-Pin, 4.1 x 4.4, 2.54P | 2500 / Tape & Reel |

[†]For information on tape and reel specifications, including part orientation and tape sizes, please refer to our Tape and Reel Packaging Specifications Brochure, BRD8011/D.

- All packages are lead free per JEDEC: J-STD-020B standard.

OPTOPLANAR is a trademark of Semiconductor Components Industries, LLC dba "onsemi" or its affiliates and/or subsidiaries in the United States and/or other countries.

MECHANICAL CASE OUTLINE
PACKAGE DIMENSIONS

ON Semiconductor®



MFP5 4.1X4.4, 2.54P
CASE 100AM
ISSUE O

DATE 31 AUG 2016

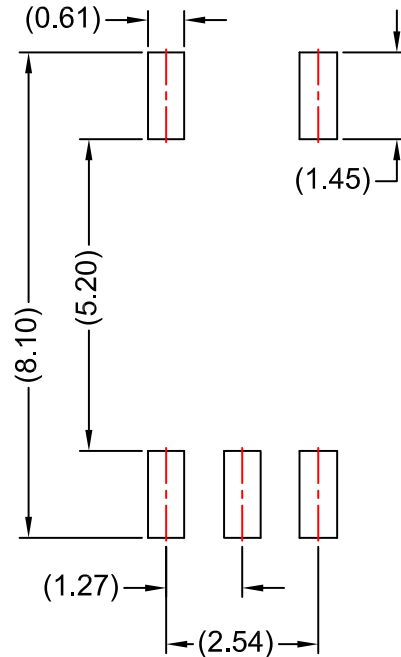
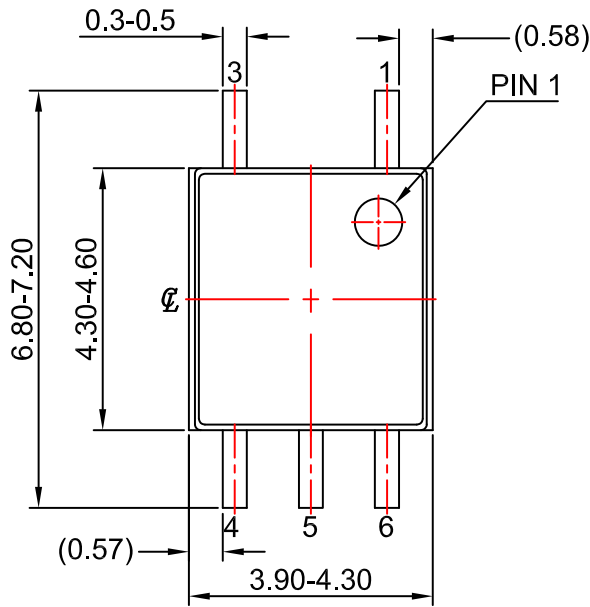

LAND PATTERN RECOMMENDATION

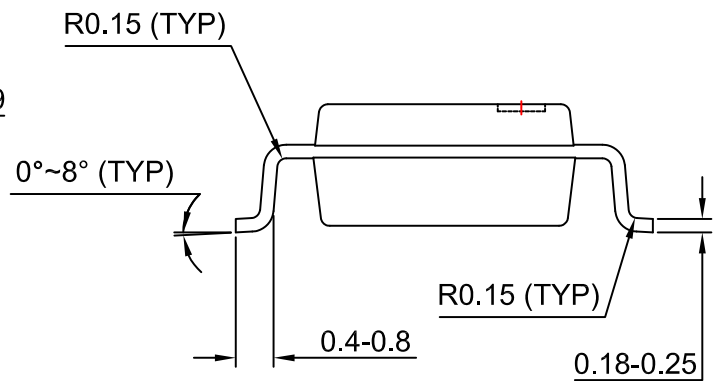
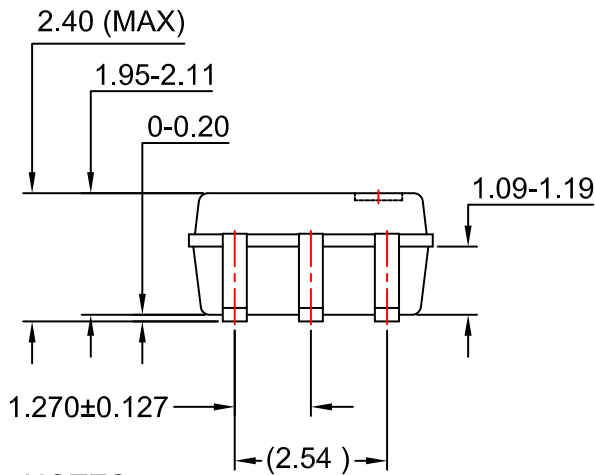

NOTES:

- A) NO STANDARD APPLIES TO THIS PACKAGE
- B) ALL DIMENSIONS ARE IN MILLIMETERS.
- C) DIMENSIONS ARE EXCLUSIVE OF BURRS, MOLD FLASH, AND TIE BAR EXTRUSION

| | | |
|-------------------------|----------------------------|--|
| DOCUMENT NUMBER: | 98AON13486G | Electronic versions are uncontrolled except when accessed directly from the Document Repository. Printed versions are uncontrolled except when stamped "CONTROLLED COPY" in red. |
| DESCRIPTION: | MFP5 4.1X4.4, 2.54P | PAGE 1 OF 1 |

ON Semiconductor and are trademarks of Semiconductor Components Industries, LLC dba ON Semiconductor or its subsidiaries in the United States and/or other countries. ON Semiconductor reserves the right to make changes without further notice to any products herein. ON Semiconductor makes no warranty, representation or guarantee regarding the suitability of its products for any particular purpose, nor does ON Semiconductor assume any liability arising out of the application or use of any product or circuit, and specifically disclaims any and all liability, including without limitation special, consequential or incidental damages. ON Semiconductor does not convey any license under its patent rights nor the rights of others.

onsemi, **Onsemi**, and other names, marks, and brands are registered and/or common law trademarks of Semiconductor Components Industries, LLC dba "**onsemi**" or its affiliates and/or subsidiaries in the United States and/or other countries. **onsemi** owns the rights to a number of patents, trademarks, copyrights, trade secrets, and other intellectual property. A listing of **onsemi**'s product/patent coverage may be accessed at www.onsemi.com/site/pdf/Patent-Marking.pdf. **onsemi** reserves the right to make changes at any time to any products or information herein, without notice. The information herein is provided "as-is" and **onsemi** makes no warranty, representation or guarantee regarding the accuracy of the information, product features, availability, functionality, or suitability of its products for any particular purpose, nor does **onsemi** assume any liability arising out of the application or use of any product or circuit, and specifically disclaims any and all liability, including without limitation special, consequential or incidental damages. Buyer is responsible for its products and applications using **onsemi** products, including compliance with all laws, regulations and safety requirements or standards, regardless of any support or applications information provided by **onsemi**. "Typical" parameters which may be provided in **onsemi** data sheets and/or specifications can and do vary in different applications and actual performance may vary over time. All operating parameters, including "Typicals" must be validated for each customer application by customer's technical experts. **onsemi** does not convey any license under any of its intellectual property rights nor the rights of others. **onsemi** products are not designed, intended, or authorized for use as a critical component in life support systems or any FDA Class 3 medical devices or medical devices with a same or similar classification in a foreign jurisdiction or any devices intended for implantation in the human body. Should Buyer purchase or use **onsemi** products for any such unintended or unauthorized application, Buyer shall indemnify and hold **onsemi** and its officers, employees, subsidiaries, affiliates, and distributors harmless against all claims, costs, damages, and expenses, and reasonable attorney fees arising out of, directly or indirectly, any claim of personal injury or death associated with such unintended or unauthorized use, even if such claim alleges that **onsemi** was negligent regarding the design or manufacture of the part. **onsemi** is an Equal Opportunity/Affirmative Action Employer. This literature is subject to all applicable copyright laws and is not for resale in any manner.

PUBLICATION ORDERING INFORMATION

LITERATURE FULFILLMENT:

Email Requests to: orderlit@onsemi.com

onsemi Website: www.onsemi.com

TECHNICAL SUPPORT

North American Technical Support:
Voice Mail: 1 800-282-9855 Toll Free USA/Canada
Phone: 011 421 33 790 2910

Europe, Middle East and Africa Technical Support:

Phone: 00421 33 790 2910

For additional information, please contact your local Sales Representative