



Quality Products. Service Excellence.

"C" Channel Mounting Kit *S2CCMK Series*



- For use in Turrets, Data Terminals and Bases.
- Provide adjustable (side to side) mounting support for Base Panels and all Rail Support Kits.
- Available in 4 widths.
- Finished in textured black.

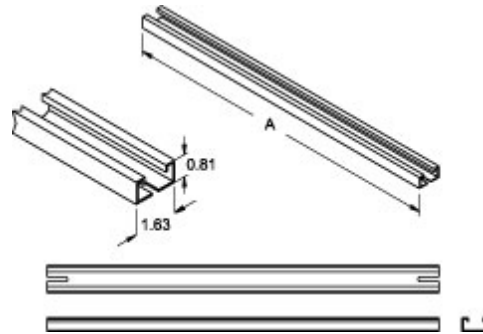

Part No.	Fits Console Width	A
2CMC24	24.00	23.50
2CMC36	36.00	33.50
2CMC48	48.00	47.50
2CMC60	60.00	59.50

Data subject to change without notice

© 2023. Hammond Manufacturing Ltd. All rights reserved.