

# CMPA601C025F

25 W, 6.0 - 12.0 GHz, GaN MMIC, Power Amplifier

## Description

The CMPA601C025F is a gallium nitride (GaN) High Electron Mobility Transistor (HEMT) based monolithic microwave integrated circuit (MMIC) on a Silicon Carbide (SiC) substrate, using a 0.25 $\mu$ m gate length fabrication process. The semiconductor offers 25 Watts of power from 6 to 12 GHz of instantaneous bandwidth. The GaN HEMT MMIC is housed in a thermally-enhanced, 10-lead 25 mm x 9.9 mm metal/ceramic flanged package. It offers high gain and superior efficiency in a small footprint package at 50 ohms.

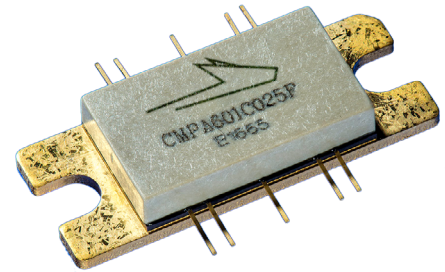

PN: CMPA601C025F  
Package Type: 440213

## Typical Performance Over 6.0 - 12 GHz ( $T_c = 25^\circ\text{C}$ )

Parameter	6.0 GHz	7.5 GHz	9.0 GHz	10.5 GHz	12.0 GHz	Units
Small Signal Gain	35	34	34	37	31	dB
$P_{OUT}$ @ $P_{IN} = 22$ dBm	34	51	49	45.9	36.5	W
Power Gain @ $P_{IN} = 22$ dBm	23	25	25	25	23.5	dB
PAE @ $P_{IN} = 22$ dBm	21	36	35	33	27	%

Note: All data CW

### Features

- 34 dB Small Signal Gain
- 40 W Typical  $P_{SAT}$
- Operation up to 28 V
- High Breakdown Voltage
- High Temperature Operation
- Size 0.172 x 0.239 x 0.004 inches

### Applications

- Jamming Amplifiers
- Test Equipment Amplifiers
- Broadband Amplifiers





## Absolute Maximum Ratings (not simultaneous) at 25°C

Parameter	Symbol	Rating	Units	Conditions
Drain-Source Voltage	$V_{DSS}$	84	$V_{DC}$	25°C
Gate-Source Voltage	$V_{GS}$	-10, +2		
Storage Temperature	$T_{STG}$	-40, +150	°C	
Operating Junction Temperature	$T_J$	225		
Maximum Forward Gate Current	$I_{GMAX}$	23	mA	25°C
Soldering Temperature <sup>1</sup>	$T_{STG}$	245	°C	
Screw Torque	$\tau$	40	in-oz	
Thermal Resistance, Junction to Case <sup>2</sup>	$R_{\theta JC}$	0.85	°C/W	85°C @ $P_{DISS} = 116W$
Case Operating Temperature <sup>2</sup>	$T_C$	-40, +150	°C	

Notes:

<sup>1</sup> Refer to the Application Note on soldering at [wolfspeed.com/rf/document-library](http://wolfspeed.com/rf/document-library)

<sup>2</sup> See also, the Power Dissipation De-rating Curve on page 5

## Electrical Characteristics (Frequency = 6.0 GHz to 12.0 GHz unless otherwise stated; $T_C = 25^\circ\text{C}$ )

Characteristics	Symbol	Min.	Typ.	Max.	Units	Conditions
<b>DC Characteristics<sup>1,2</sup></b>						
Gate Threshold	$V_{TH}$	-3.8	-2.8	-2.3	V	$V_{DS} = 10\text{ V}, I_D = 23\text{ mA}$
Saturated Drain Current	$I_{DS}$	10.6	13.0		A	$V_{DS} = 6\text{ V}, I_{GS} = 2\text{ V}$
Drain-Source Breakdown Voltage	$V_{BD}$	84	100	—	V	$V_{GS} = -8\text{ V}, I_{DS} = 23\text{ mA}$
<b>RF Characteristics<sup>3</sup></b>						
Small Signal Gain at 6.0 - 10.5 GHz	S21	28	31	—	dB	$V_{DD} = 28\text{ V}, I_{DQ} = 2\text{ A}, P_{IN} = -30\text{ dBm}$
Small Signal Gain at 10.5 - 12 GHz		25	28	—		
Output Power at 6 GHz <sup>3,4</sup>	$P_{OUT1}$	45.5	47.2	—	dBm	$V_{DD} = 28\text{ V}, I_{DQ} = 2\text{ A}, P_{IN} = 22\text{ dBm}$
Output Power at 9.5 GHz <sup>3,4</sup>	$P_{OUT2}$	45.5	47.1	—		
Output Power at 12 GHz <sup>3,4</sup>	$P_{OUT3}$	43.0	44.8	—		
Power Added Efficiency at 6 GHz <sup>3,4</sup>	$PAE_1$	23	33.2	—	%	
Power Added Efficiency at 9.5 GHz <sup>3,4</sup>	$PAE_2$	26	32.3	—		
Power Added Efficiency at 12 GHz <sup>3,4</sup>	$PAE_3$	15.5	26.5	—		
Input Return Loss	S11	—	-5	—	dB	$V_{DD} = 28\text{ V}, I_{DQ} = 2\text{ A}, P_{IN} = -30\text{ dBm}$
Output Return Loss	S22	—		—		
Output Mismatch Stress	VSWR	—	—	5:1	Ψ	No damage at all phase angles, $V_{DD} = 28\text{ V}, I_{DQ} = 2\text{ A}, P_{IN} = 22\text{ dBm}$

Notes:

<sup>1</sup> Measured on-wafer prior to packaging

<sup>2</sup> Scaled from PCM data

<sup>3</sup> Measured in CMPA601C025F-AMP with 12.4 GHz low pass filter

<sup>4</sup> Fixture loss de-embedded using the following offsets. The offset is subtracted from the input offset value and added to the output offset value.

- a) 6.0 GHz - 0.13 dB
- b) 9.50 GHz - 0.26 dB
- c) 12.0 GHz - 0.35 dB



**CMPA601C025F Typical Performance**

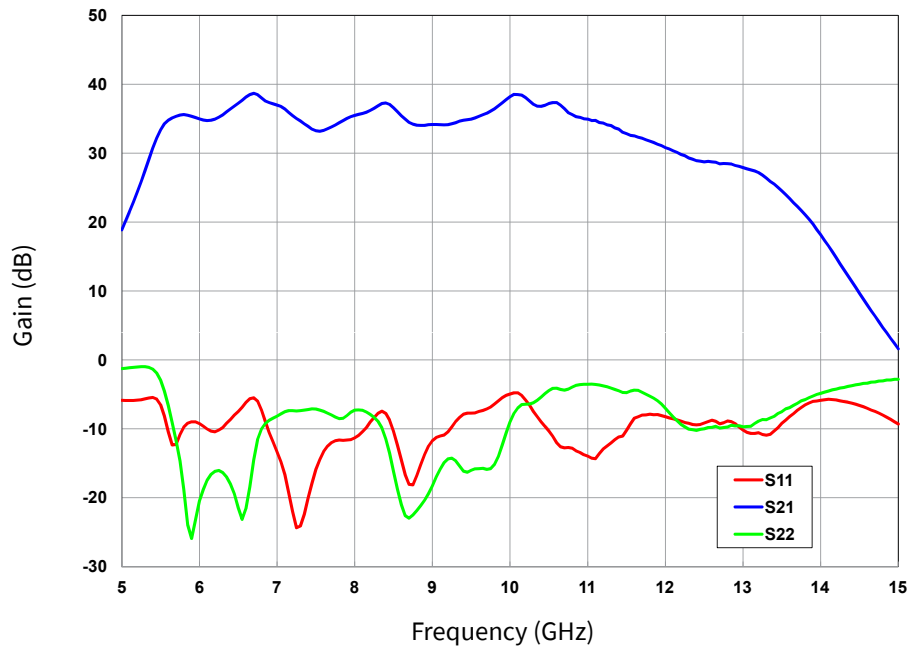

**Figure 1.** Small Signal S-Parameters vs. Frequency  
 $V_{DD} = 28\text{ V}$ ,  $I_{DQ} = 2.0\text{ A}$ ,  $P_{IN} = -30\text{ dBm}$

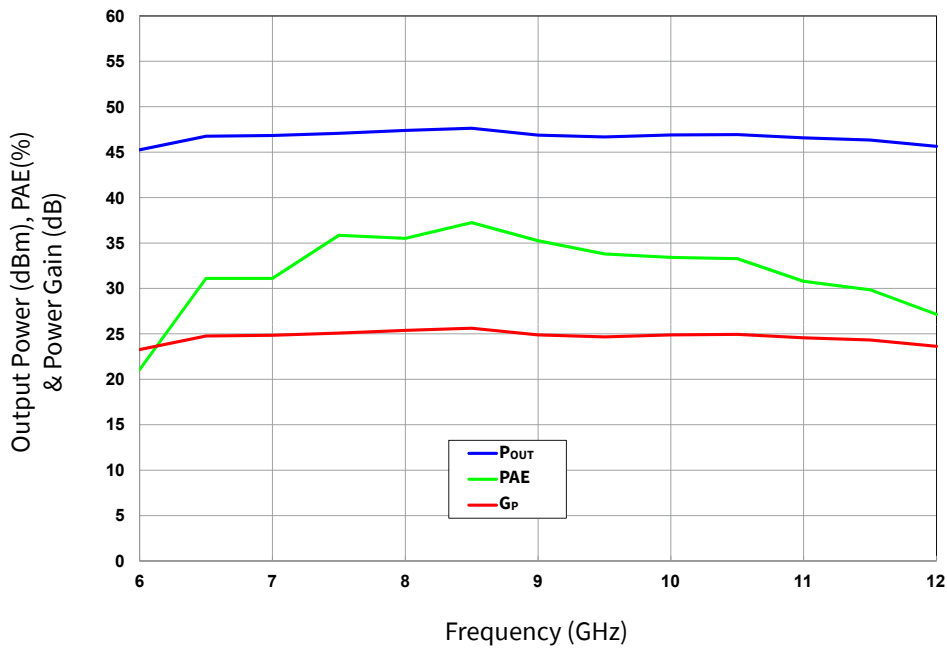

**Figure 2.** Output Power, Gain and Power Added Efficiency vs. Input Power  
 $V_{DD} = 28\text{ V}$ ,  $I_{DQ} = 2.0\text{ A}$ ,  $P_{IN} = 22\text{ dBm}$



**CMPA601C025F Typical Performance**

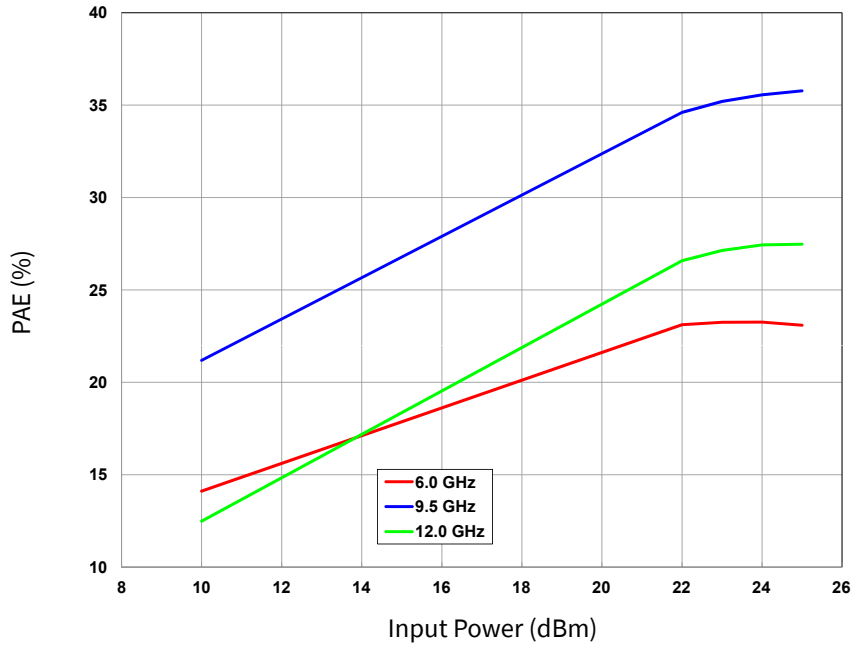

**Figure 3.** Power Added Efficiency vs. Input Power  
 $V_{DD} = 28\text{ V}, I_{DQ} = 2.0\text{ A}$

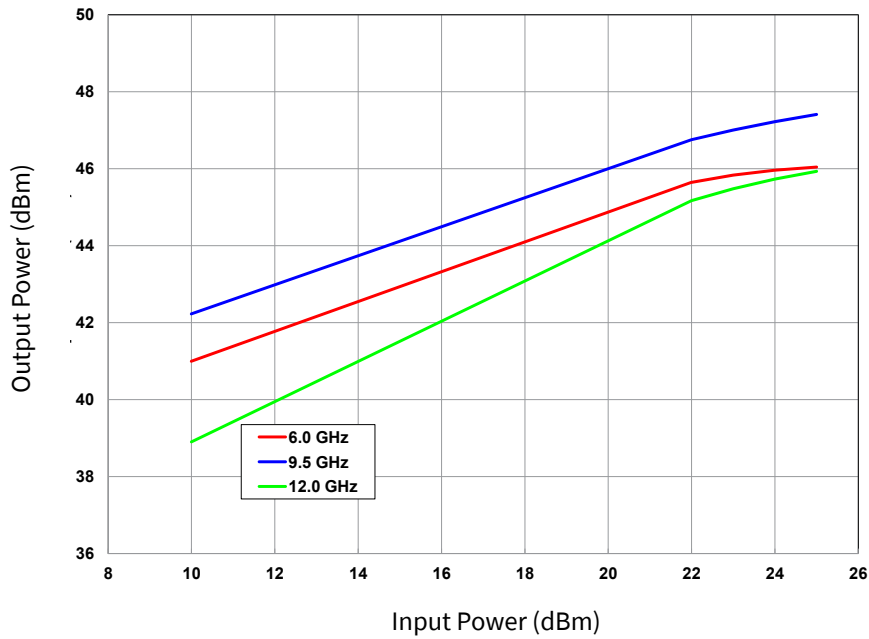

**Figure 4.** Output Power vs. Input Power  
 $V_{DD} = 28\text{ V}, I_{DQ} = 2.0\text{ A}$



**CMPA601C025F Typical Performance**

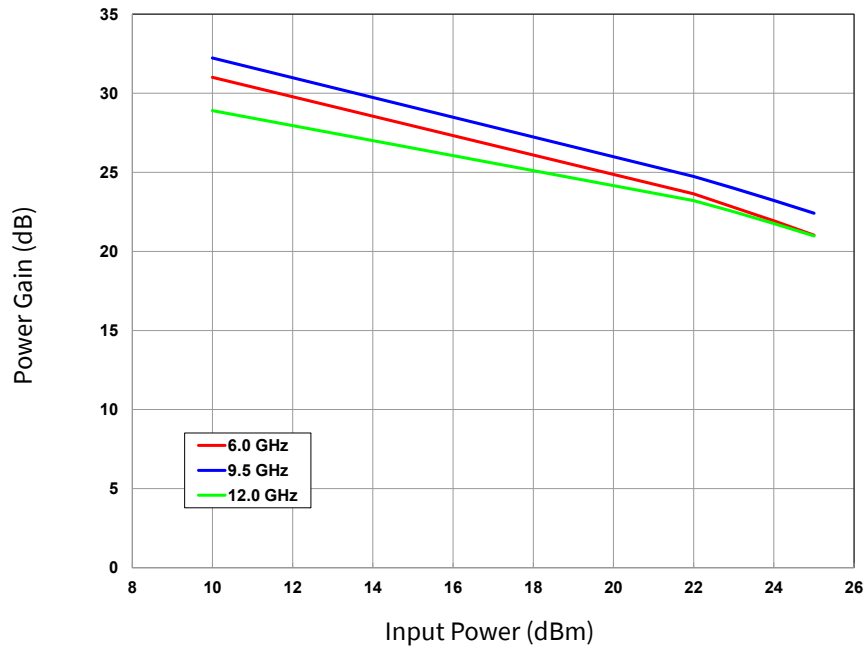

**Figure 5. Gain vs Input Power**  
 $V_{DD} = 28\text{ V}, I_{DQ} = 2.0\text{ A}$

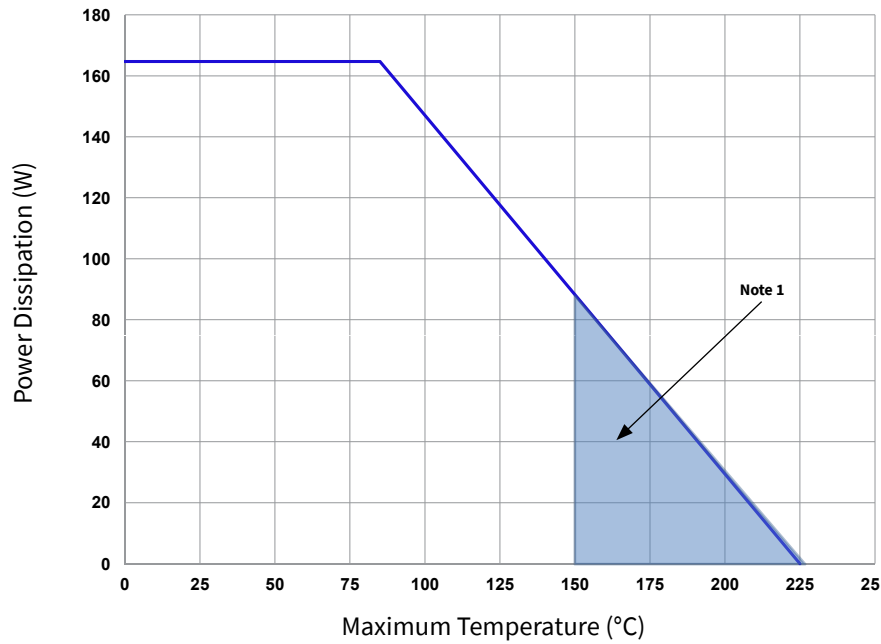

**Figure 6. Power Dissipation Derating Curve**

Notes:

<sup>1</sup> Area exceeds Maximum Case Operating Temperature (See Page 2)

**CMPA601C025F-AMP Demonstration Amplifier Circuit Bill of Materials**

Designator	Description	Qty
C2, C4, C5, C7, C9, C12	CAP, 33000pF, 0805, 100V, X7R	6
C1, C3, C6, C8, C10, C13	CAP, 1.0μF, 100V, 10%, X7R, 1210	6
C11, C14	CAP ELECT 3.3μF 80V FK SMD	2
R1, R2	RES 0.0 OHM 1/16W 0402 SMD	2
J1, J2	CONN, SMA, PANEL MOUNT JACK, FLANGE, 4-HOLE, BLUNT POST, 20MIL	2
J3	HEADER RT>PLZ .1CEN LK 9POS	1
W1	WIRE, BLACK, 22 AWG ~ 1.50"	1
W2	WIRE, BLACK, 22 AWG ~ 1.75"	1
Q1	CMPA601C025F	1

**CMPA601C025F-AMP Demonstration Amplifier Circuit**

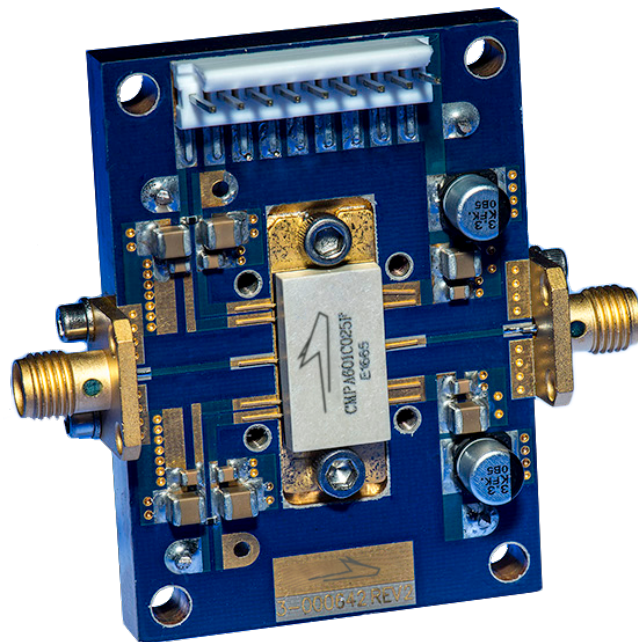



### CMPA601C025F-AMP Demonstration Amplifier Circuit Schematic

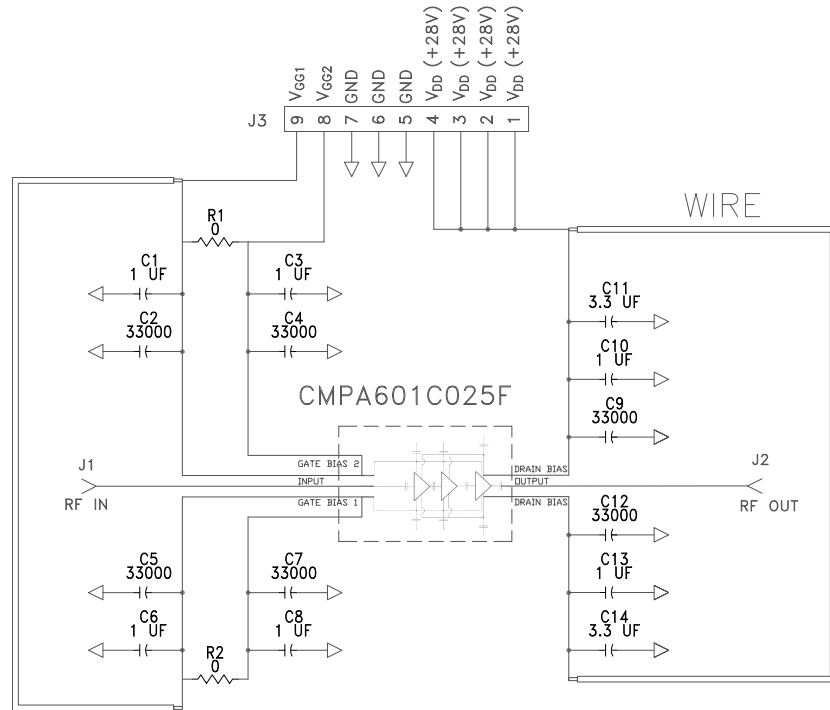

### CMPA601C025F-AMP Demonstration Amplifier Circuit Outline

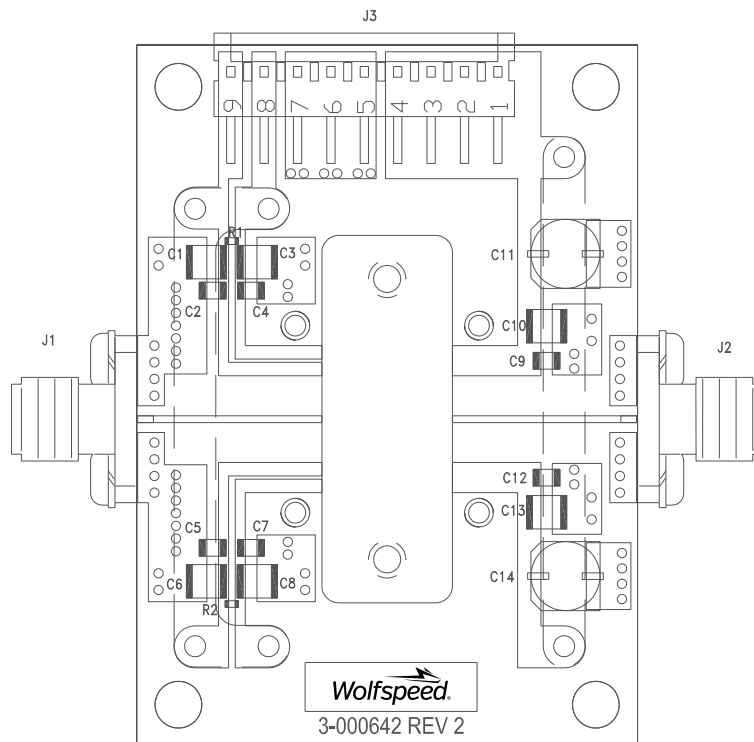



**Product Dimensions CPM601C025F**

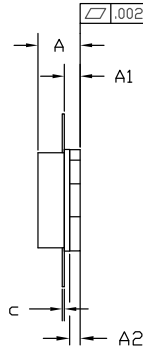
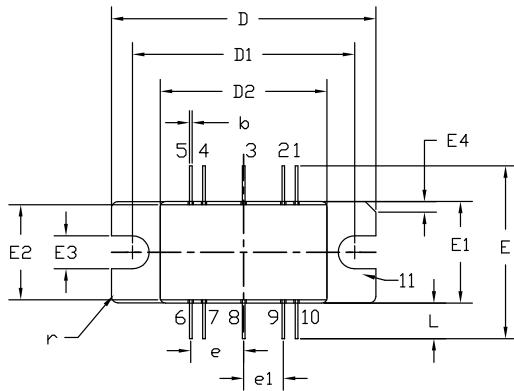

PIN 1: GATE BIAS 6: DRAIN BIAS  
 2: GATE BIAS 7: DRAIN BIAS  
 3: RF IN 8: RF OUT  
 4: GATE BIAS 9: DRAIN BIAS  
 5: GATE BIAS 10: DRAIN BIAS  
 11: SOURCE

NOTES:

1. DIMENSIONING AND TOLERANCING PER ANSI Y14.5M - 1994.
2. CONTROLLING DIMENSION: INCH.
3. ADHESIVE FROM LID MAY EXTEND A MAXIMUM OF 0.020" BEYOND EDGE OF LID.
4. LID MAY BE MISALIGNED TO THE BODY OF PACKAGE BY A MAXIMUM OF 0.008" IN ANY DIRECTION.

DIM	INCHES		MILLIMETERS		NOTES
	MIN	MAX	MIN	MAX	
A	0.155	0.175	3.94	4.45	
A1	0.055	0.065	1.40	1.65	
A2	0.035	0.045	0.89	1.14	
b	0.01	TYP	0.254	TYP	10x
c	0.007	0.009	0.18	0.23	
D	0.995	1.005	25.27	25.53	
D1	0.835	0.845	21.21	21.46	
D2	0.623	0.637	15.82	16.18	
E	0.653	TYP	16.59	TYP	
E1	0.380	0.390	9.65	9.91	
E2	0.355	0.365	9.02	9.27	
E3	0.120	0.130	3.05	3.30	
E4	0.035	0.045	0.89	1.14	45° CHAMFER
e	0.200	TYP	5.08	TYP	4x
e1	0.150	TYP	3.81	TYP	4x
L	0.115	0.155	2.92	3.94	10x
r	0.025	TYP	.635	TYP	3x

Pin Number	Qty
1	Gate Bias for Stage 1, 2 & 3
2	Gate Bias for Stage 1, 2 & 3
3	RF <sub>IN</sub>
4	Gate Bias for Stage 1, 2 & 3
5	Gate Bias for Stage 1, 2 & 3
6	Drain Bias
7	Drain Bias
8	RF <sub>OUT</sub>
9	Drain Bias
10	Drain Bias

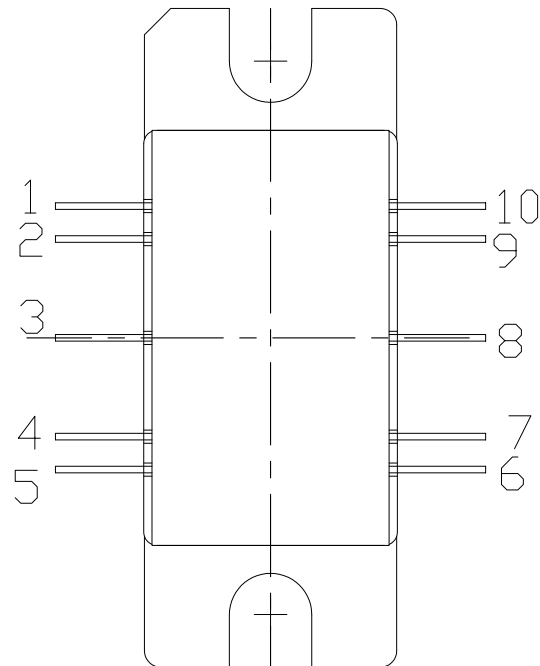





## Part Number System

### CMPA601C025F

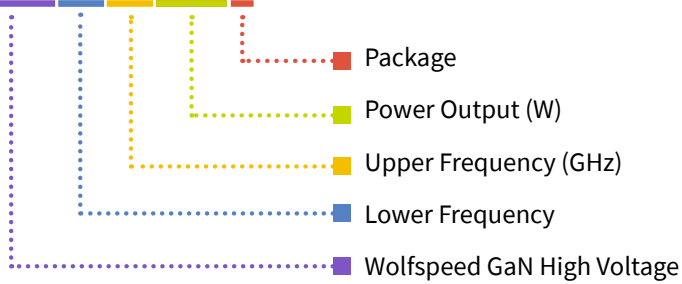

**Table 1.**

Parameter	Value	Units
Lower Frequency	6.0	GHz
Upper Frequency <sup>1</sup>	12.0	GHz
Power Output	25	W
Package	Flanged	—

Note:  
<sup>1</sup> Alpha characters used in frequency code indicate a value greater than 9.9 GHz. See Table 2 for value.

**Table 2.**

Character Code	Code Value
A	0
B	1
C	2
D	3
E	4
F	5
G	6
H	7
J	8
K	9
Examples:	1A = 10.0 GHz 2H = 27.0 GHz

## Electrostatic Discharge (ESD) Classifications

Parameter	Symbol	Class	Classification Level	Test Methodology
Human Body Model	HBM	1A	ANSI/ESDA/JEDEC JS-001 Table 3	JEDEC JESD22 A114-D
Charge Device Model	CDM	C3	ANSI/ESDA/JEDEC JS-002 Table 3	JEDEC JESD22 C101-C

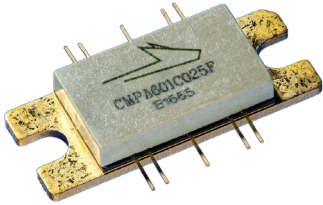
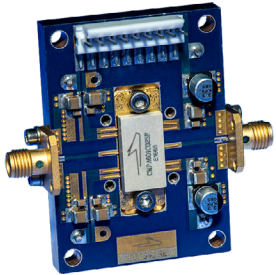

**Product Ordering Information**

Order Number	Description	Unit of Measure	Image
CMPA601C025F	GaN HEMT	Each	
CMPA601C025F-AMP	Test board with GaN HEMT installed	Each	

**For more information, please contact:**

4600 Silicon Drive  
Durham, NC 27703 USA  
Tel: +1.919.313.5300  
[www.wolfspeed.com/RF](http://www.wolfspeed.com/RF)

Sales Contact  
[RFSales@wolfspeed.com](mailto:RFSales@wolfspeed.com)

RF Product Marketing Contact  
[RFMarketing@wolfspeed.com](mailto:RFMarketing@wolfspeed.com)

## Notes & Disclaimer

---

Specifications are subject to change without notice. “Typical” parameters are the average values expected by Wolfspeed in large quantities and are provided for information purposes only. Wolfspeed products are not warranted or authorized for use as critical components in medical, life-saving, or life-sustaining applications, or other applications where a failure would reasonably be expected to cause severe personal injury or death. No responsibility is assumed by Wolfspeed for any infringement of patents or other rights of third parties which may result from use of the information contained herein. No license is granted by implication or otherwise under any patent or patent rights of Wolfspeed.

© 2014-2022 Wolfspeed, Inc. All rights reserved. Wolfspeed® and the Wolfstreak logo are registered trademarks and the Wolfspeed logo is a trademark of Wolfspeed, Inc.  
PATENT: <https://www.wolfspeed.com/legal/patents>

*The information in this document is subject to change without notice.*