

SD-50X

4-20mA Loop Powered Meter
5 Digit with 0.5" LCD
in a 1/8 DIN Ultra Short Depth Case

World's first 50,000 count, loop powered meter is incredibly easy to scale, from the front panel, to any desired engineering unit of measurement.

General Features

The SD-50X is the ultimate advancement in ease of use from the company that developed the worlds first 4-20 mA loop powered meters.

The SD-50X features lockable front panel scaling and calibration. Any 4 to 20 mA signal can be scaled from almost any two input values to display any required engineering unit of measure. A 4-20 mA input can display 50,000 counts of resolution from -19,999 to +30,000. The 6th digit can be selected to display °F, °C or an inactive extra zero from a dip switch at the rear of the case.

With less than a 4 V loop drop, this meter can be inserted in the 24 V input loop excitation provided by our Lynx, Leopard and Tiger meter families. The optional 4-20 mA outputs from these meters can power several SD-50X units as remote displays.

Two SD-50X meters can be mounted in a 96x96 DIN cutout and powered from the same loop, but display different scale readings such as °F and °C, lbs and kg or psi and Torr.

Easy scaling and high resolution also enables the SD-50X to be used as a precision counting scale, for nuts and bolts, barrels or boxes.

Typical Application Connections

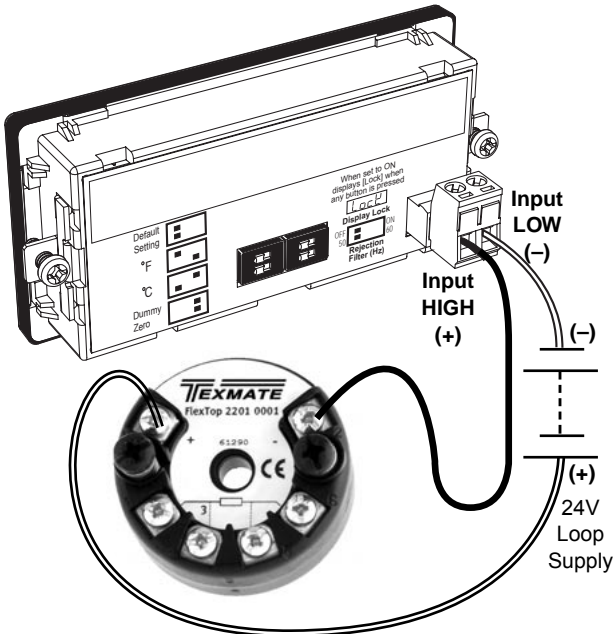

Compatibility

The SD-50X has a matching DIN case style and panel appearance that is complementary to the Lynx, Leopard and Tiger family of meters, except the depth behind the panel is only 15 mm (0.59"). The SD-50X makes an ideal extra or remote display as it can operate either in conjunction with the 4-20 mA loop input or operate from the 4-20 mA analog output of most Leopard or Tiger meters.

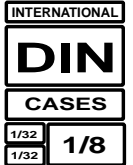

Specifications

Input Configuration: Series connection to 4-20 mA DC current loop. 3.4 volts drop, plus 20 Ω (equivalent to 3.9 V @ 20 mA)

Full Scale Ranges: Standard meter is adjustable to any Display Span between a max negative reading of -19,999 and a max positive reading of 30,000, max resolution (50,000 counts), from any signal input span between 3.5 mA and 27.5 mA.

A/D Converter: 16 Bit Sigma Delta

Accuracy: ±0.02% of reading plus 2 digits

Temperature Coefficient: Typically 30 ppm/ °C plus 0.1 counts/ °C for zero offset.

Warm Up Time: One minute to specified accuracy

Conversion Rate: 3 readings per second

Display: Liquid Crystal Display (LCD) 0.5"

Polarity: Assumed positive, displays - negative

Descriptors: Dip switch selectable dummy zero, °C, °F

Decimal Point: User programmable to six positions

Positive Over-range: Display shows -----

Negative Over-range: Display shows -----

Power Supply: Designed to be powered from the 4-20 mA current loop input signal. Min input 3.5 mA, Max continuous input 100 mA. 3.4 volts drop, plus 20 Ω (equivalent to 3.9 V @ 20 mA). Typically load is 200 Ω.

Operating Temperature: ...-10°C to +50°C

Storage Temperature:-20°C to +70°C

Relative Humidity: 95% (non-condensing)

Case Dimensions: 1/8 DIN, Bezel: 96x48 mm (3.78"x1.89")
Depth behind bezel 15 mm (0.59") plus 16.4 mm (0.65") for right-angled Connector

Weight: 56.7 gms (2 oz)
141.7 gms (5 oz) when packed

SD-Series, Short Depth Meters

SD-35 0.2 / 2 / 20 / 200 / Custom DC V ranges, 3.5 digit, 5 V DC Powered

SD-50X 5 Digit 4-20 mA Loop Powered

Controls and Indicators

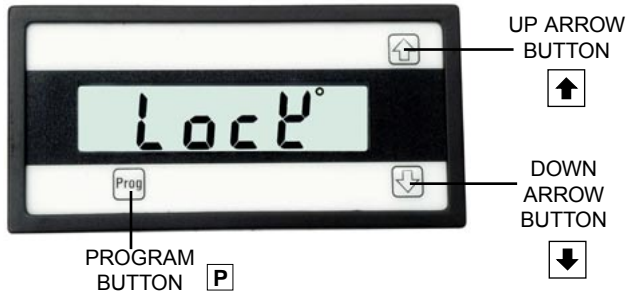

PROGRAM BUTTON: This button is used to move from one program step to the next. When pressed simultaneously with the UP ARROW button, the Programming Mode is entered.

UP ARROW BUTTON: Increases the value of the displayed parameter.

DOWN ARROW BUTTON: Decreases the value of the displayed parameter.

NOTE: When the display lock switch is on and any button is pressed, the display will show only [Lock] momentarily as shown above and then return to the normal operational display.

Dip Switch Settings

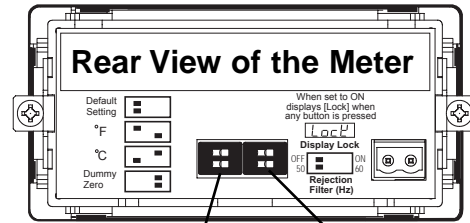

Effect on Display	Digit/Descriptor	Display Lock/ Frequency
	Default Setting 1 <input type="checkbox"/> ON 2 <input type="checkbox"/>	When set to ON displays [Lock] when any button is pressed Display Lock OFF 1 <input type="checkbox"/> ON 2 <input type="checkbox"/> ON 60 Rejection Filter (Hz)
	°F 1 <input type="checkbox"/> ON 2 <input type="checkbox"/>	
	°C 1 <input type="checkbox"/> ON 2 <input type="checkbox"/>	
	Dummy Zero 1 <input type="checkbox"/> ON 2 <input type="checkbox"/>	

Two Point Digital Scaling and Calibration - Quick Reference Guide

Two Point Calibration and Scaling

Example: 4 to 20 mA input to read 0 to 20,000

Step 1

Operational Display
29999

Set DIP switch to lock OFF

Enter the Calibration Mode

Step 2

cALoFF

Select [cAL on]

OR

Step 3

cAL on

Enter the LOW Input [Lo in] Mode

Maximum positive reading is 30,000 & maximum negative reading is -19,999. Maximum display span is 50,000 counts.

Step 4

Lo in

Adjust display to desired reading for LOW input

OR

Any value between -19,999 and 30,000 may be selected. Reverse scaling is accepted.

Step 5

0

Set the LOW input value and enter the HIGH Input [hi in] Mode

If the input signal is disconnected after Step 5, the [Lo in] values are saved, and the meter automatically returns to the [hi in] mode when signal power is re-applied.

Step 6

hi in

Adjust display to the desired reading for HIGH input

OR

Max difference between [hi in] & [Lo in] display values selected cannot exceed 32,000 counts.

Step 7

20000

Set the HIGH input value and return to Operational Display

Operational Display

29999

Set DIP Switch to Lock On

If display shows [cALerr] the calibration has been canceled and the previously calibrated scale factors are retained in memory. (See page 2, para 5)

Decimal Point Setting

Step 1

Operational Display
29999

Set DIP switch to lock OFF

Enter the Calibration Mode

Step 2

cALoFF

Pass Calibration Mode and enter Decimal Point Setting Mode

Step 3

dPo int

Adjust the decimal point to the desired position

OR

Step 4

dPo int

Set the decimal point position and return to Operational Display

Operational Display

29999

Set DIP switch to lock ON

Two Point Digital Scaling and Calibration - Detailed Parameters and Notes

The SD-50X is incredibly easy to use, and almost any engineering unit or desired display scale can be obtained from almost any input signal value within the following parameters.

Min/Max Input Signal Range and Compliance Voltage

The operational signal range of the meter is 4 to 20 mA. The minimum acceptable input signal is 3.5 mA. The maximum acceptable input signal is 27.5 mA.

The signal must have a compliance voltage of at least 4 V (200 Ω load). For scaling and calibration the input signal should be capable of adjustment between two output values for which the required display value is precisely known.

Scaling can be accomplished with as little as 0.1 mA difference between high and low input signals. However, full scale accuracy is easier to achieve when there is at least a 4 mA difference between the high and low calibration points of the input signal.

Maximum Display Readings

The maximum positive reading that can be displayed is +30000. The maximum negative reading is -19999. Therefore, the maximum viewable digital display span is 50000 counts. Any combination of input signal and scaling that causes the digital display span to exceed these limits produces a display of ----- for over-range or _ _ _ _ _ for under-range.

Maximum Range of Input Values for Calibration

For calibration or scaling, the [Lo in] calibration mode is accessed first and the low input signal is applied first. Because reverse scalings are accepted, any display value between -19999 and +30000 may be entered. Likewise, when the [hi in] mode is accessed and the high signal is applied any desired display value between -19999 and +30000 may also be entered. However, the maximum difference between the two display values entered cannot exceed 32000 counts.

Calibration Error Display [cALErr]

If, after entering the calibration values, the difference between the high and low input signal is insufficient (less than 0.1 mA), or if the difference between the two display values exceeds 32000 counts, the meter displays [cALErr]. The calibration values entered are cancelled and the previously calibrated scale factor is retained in memory.

Loss of Input Signal Power During Calibration

If the input signal is disconnected, after the LOW input signal has been applied and the PROGRAM button pressed, the [Lo in] value will be retained. After the signal power is re-applied, the meter automatically returns to the calibration [hi in] mode. The HIGH input signal can then be applied and the [hi in] value

entered. This feature is particularly useful when the available calibration signal cannot be adjusted between two known values without discontinuity.

Spans From 32000 Up to the Max 50000 Counts of Display Require Proportional Scaling

There is a 32000 count maximum difference permitted between the [Lo in] and [hi in] display values that can be selected during calibration. In order to achieve display resolutions between 32000 and 50000 counts, it is necessary to scale and calibrate the meter at a lower input signal span than the span at which the meter is intended to be operated.

For Example:

An input of 4 to 20 mA is required to read -19999 to +30000. Signal Span = 16 mA and Display Span = 50000 counts.

To calibrate the meter in this example with a [Lo in] signal of 4 mA and a [hi in] signal of 20 mA, the difference between the low and high values required would be 50000 counts. This exceeds the 32000 count maximum difference by 18000 counts. Therefore, a lower input signal span should be used.

Proportional Scaling at 50% of Full Scale (High Side)

In the example, a signal change from 12 mA to 20 mA (8 mA = 50% of signal span) produces a display change from 5000 to 30000 (a 25000 count change). With a [Lo in] signal of 12 mA, the display value could be set to 5000, and with a [hi in] signal of 20 mA, the display value could be set to 30000. Result: a signal of 4 to 20 mA would read -19999 to +30000.

Proportional Scaling at 50% of Full Scale (Low Side)

Conversely, in the above example, a signal change from 4 mA to 12 mA (8 mA = 50% of signal span), would produce a display change from -19999 to +5000 (which is also a 25000 count change). Accordingly, the same scaling/calibration result could be achieved while remaining within the 32000 count maximum. With a [Lo in] signal of 4 mA the display value could be set to -19999, and with a [hi in] signal of 12 mA the display value could be set to +5000. Result: the meter will then also be calibrated so that an input of 4 to 20 mA will display -19999 to +30000.

Proportional Scaling at 25% of Full Scale

Similarly, a signal change from 4 mA to 8 mA (4 mA = 25% of signal span) would produce a display change from -19999 to -7500 (a 12500 count change is 25% of 50000). With a [Lo in] signal of 4 mA the display value could be set to -19999, and with a [hi in] signal of 8 mA the display value could be set to -7500. Result: the same scaling is also achieved, and an input of 4 to 20 mA will display -19000 to +30000.

Custom Face Plates



Texmate Produces Thousands of Custom OEM Face Plates

Have Texmate Design and Build a Custom Face Plate to Suit your Next project!

- Custom face plates have a non-recurring artwork charge. A serial number is then assigned to each artwork, to facilitate reordering.

- Small Run or One-Off custom face plates incur an installation charge, and are generally printed on a special plastic film, which is then laminated to custom faceplate blanks as required.
- Large Run (250 pieces min): custom face plates are production silk screened, issued a part number, and held in stock for free installation as required by customer orders.
- OEMs may also order Custom Meter Labels, Box Labels Custom Data Sheets and Instruction Manuals.

SD Case Dimensions and Panel Cutouts

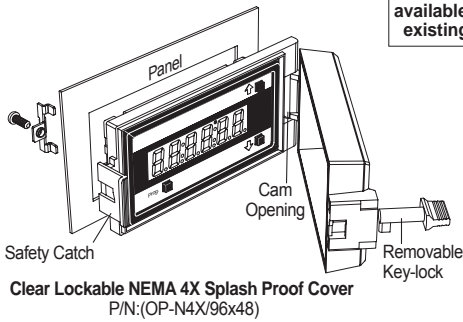
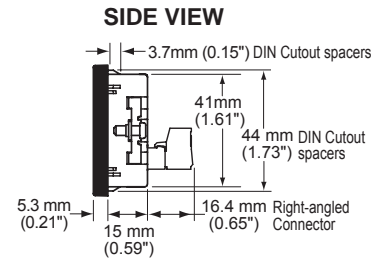
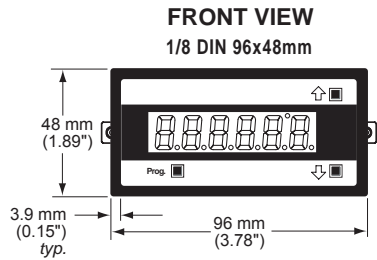
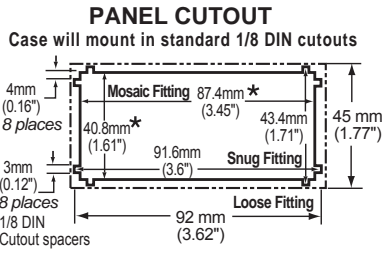

Panel adaptor plates are available to retrofit most existing panel cutouts.

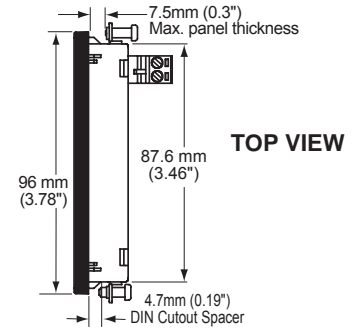
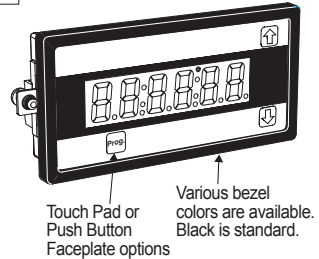

The clear lockable cover is designed to be dust and water proof to NEMA-4X, IP65 standards. The assembly consists of a base and cover with a cam hinge and key-lock fastening mechanism. An O-ring, or neoprene gasket forms a seal between the base and the panel. The cam hinge prevents the cover from closing when opened until pushed closed. The cover has a tapered recess that, when closed, forms a seal with a tapered spigot on the base. A key-lock employs a cam locking device to force the spigot into the recess, ensuring seal integrity. A safety catch keeps the cover closed even when the key is removed, and the keyhole can be used to attach a safety seal clip, preventing unauthorized opening.

Front Bezel Descriptors

AC	Ω	kV	kVAR	m ³ /hr	Hz	RPM
V	mV	min	PF	°F	°C	Cosθ
DC	x10kN	μA	PSIG	mS	kg/cm ²	psi
kW	W	KWH	pH	%	K	kPa
A	mbar	mA	MW	kA	RPS	MWH
mWs	μm	kW/s	I	I/sec	ml	cm
DRP	mm/s	1/min	mm	kg/sec	lbs	kg/hr
FT	bars	min ⁻¹	m/min	Mvars	μV	dB

To customize the front bezel, each SD-meter is supplied with a white printed clear adhesive label containing various popular descriptors. Choose the descriptors desired, peel off the adhesive backing and align the descriptors in the center right of the faceplate.

Ordering Information

Standard Options for this Model Number

Part Number	Description	List
-------------	-------------	------

► BASIC MODEL NUMBER

Includes plug in type screw terminals and standard LCD display.

SD-50X.....DPM, 4 to 20 mA DC Loop Powered Touch-pad Faceplate

► DISPLAY

STANDARD.....LCD, 5 Digit, 0.56" with selectable °F, °C or extra 0 .N/C

Special Options and Accessories

► SPECIAL OPTIONS (Specify Inputs or Outputs & Req. Reading)

CB-FS50Custom Scaling within the standard 4 to 20mA range

► ACCESSORIES (Specify Serial # for Custom Artwork Installation)

- 75-DBBZ9648FBlack Bezel for 96x48mm Case
- 93-PLUG2P-DPExtra Screw Terminal Conn., 2 Pin Plug
- OP-N4X/96X48Clear Lockable Water-proof cover, Nema 4X, IP65
- OP-SD50XPBPush-Button faceplate option for SD-50X
- OP-PSA/96X48Panel Cutout Reinforcer with O-Ring Seal
- OP-PMA96X48Panel Cutout Reinforcer with 2 Brackets & Clips
- ART-FS-S/DNRC for Artwork & set-up Custom Faceplate and or Descriptors ...
- ART-FS-S/D/CNRC for Artwork & set-up Custom Faceplate and Custom Logo ...
- ART-FS-001Produce & Install Custom Faceplate per meter - 1 color no-min ...
- ART-FS-002Produce & Install Custom Faceplate per meter - 2 color no-min ...
- ART-FS-003Produce & Install Custom Faceplate per meter - 3 color no-min ...
- ART-FL-001Custom Faceplate, 250 piece Min. (\$1.00 each) - 1 color
- ART-FL-002Custom Faceplate, 250 piece Min. (\$1.40 each) - 2 color
- ART-FL-003Custom Faceplate, 250 piece Min. (\$1.80 each) - 3 color

Many other options and accessories are available. See full price list for more details. Prices subject to change without notice.

WARRANTY

Texmate warrants that its products are free from defects in material and workmanship under normal use and service for a period of one year from date of shipment. Texmate's obligations under this warranty are limited to replacement or repair, at its option, at its factory, of any of the products which shall, within the applicable period after shipment, be returned to Texmate's facility, transportation charges pre-paid, and which are, after examination, disclosed to the satisfaction of Texmate to be thus defective. The warranty shall not apply to any equipment which shall have been repaired or altered, except by Texmate, or which shall have been subjected to misuse, negligence, or accident. In no case shall Texmate's liability exceed the original purchase price. The aforementioned provisions do not extend the original warranty period of any product which has been either repaired or replaced by Texmate.

USER'S RESPONSIBILITY

We are pleased to offer suggestions on the use of our various products either by way of printed matter or through direct contact with our sales/application engineering staff. However, since we have no control over the use of our products once they are shipped, NO WARRANTY WHETHER OF MERCHANTABILITY, FITNESS FOR PURPOSE, OR OTHERWISE is made beyond the repair, replacement, or refund of purchase price at the sole discretion of Texmate. Users shall determine the suitability of the product for the intended application before using, and the users assume all risk and liability whatsoever in connection therewith, regardless of any of our suggestions or statements as to application or construction. In no event shall Texmate's liability, in law or otherwise, be in excess of the purchase price of the product.

Texmate cannot assume responsibility for any circuitry described. No circuit patent licenses are implied. Texmate reserves the right to change circuitry, specifications, and prices without notice at any time.



450 State Place, Escondido, CA 92029
Tel: (760) 598-9899 • Fax: (760) 598-9828
URL: www.texmate.com

Texmate has facilities in Japan, New Zealand, Taiwan, and Thailand. We also have authorized distributors throughout the USA and in 28 other countries.

Local Distributor Address: