

# STEALTH™ Diode

30 A, 600 V

## ISL9R3060G2, ISL9R3060P2

### Description

The ISL9R3060G2, ISL9R3060P2 is a STEALTH™ diode optimized for low loss performance in high frequency hard switched applications. The STEALTH family exhibits low reverse recovery current ( $I_{rr}$ ) and exceptionally soft recovery under typical operating conditions. This device is intended for use as a free wheeling or boost diode in power supplies and other power switching applications. The low  $I_{rr}$  and short  $t_a$  phase reduce loss in switching transistors. The soft recovery minimizes ringing, expanding the range of conditions under which the diode may be operated without the use of additional snubber circuitry. Consider using the STEALTH diode with an SMPS IGBT to provide the most efficient and highest power density design at lower cost.

### Features

- Stealth Recovery,  $t_{rr} = 36$  ns (@  $I_F = 30$  A)
- Max Forward Voltage,  $V_F = 2.4$  V (@  $T_C = 25^\circ\text{C}$ )
- 600 V Reverse Voltage and High Reliability
- Avalanche Energy Rated
- This Device is Pb-Free and is RoHS Compliant

### Applications

- SMPS
- Hard Switched PFC Boost Diode
- UPS Free Wheeling Diode
- Motor Drive FWD
- SMPS FWD
- Snubber Diode



ON Semiconductor®

[www.onsemi.com](http://www.onsemi.com)

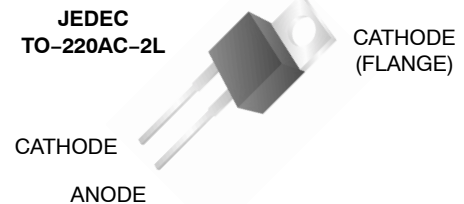
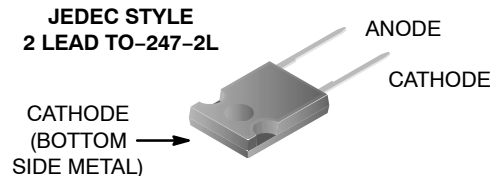

### MARKING DIAGRAM

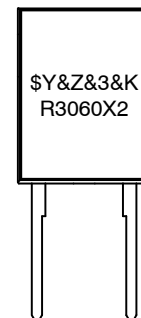

\$Y	= ON Semiconductor Logo
&Z	= Assembly Plant Code
&3	= Numeric Date Code
&K	= Lot Code
R3060X2	= Specific Device Code
X	=G/P



### ORDERING INFORMATION

See detailed ordering and shipping information on page 2 of this data sheet.

# ISL9R3060G2, ISL9R3060P2

## DEVICE MAXIMUM RATINGS ( $T_C = 25^\circ\text{C}$ unless otherwise noted)

Rating	Symbol	Value	Unit
Peak Repetitive Reverse Voltage	$V_{RRM}$	600	V
Working Peak Reverse Voltage	$V_{RWM}$	600	V
DC Blocking Voltage	$V_R$	600	V
Average Rectified Forward Current	$I_{F(AV)}$	30	A
Repetitive Peak Surge Current (20 kHz Square Wave)	$I_{FRM}$	70	A
Nonrepetitive Peak Surge Current (Halfwave, 1 Phase, 60 Hz)	$I_{FSM}$	325	A
Power Dissipation	$P_D$	200	W
Avalanche Energy (1 A, 40 mH)	$E_{AVL}$	20	mJ
Operating and Storage Temperature Range	$T_J, T_{STG}$	-55 to 175	$^\circ\text{C}$
Maximum Temperature for Soldering Leads at 0.063 in (1.6 mm) from Case for 10 s	$T_L$	300	$^\circ\text{C}$
Maximum Temperature for Soldering Package Body for 10 s	$T_{PKG}$	260	$^\circ\text{C}$

Stresses exceeding those listed in the Maximum Ratings table may damage the device. If any of these limits are exceeded, device functionality should not be assumed, damage may occur and reliability may be affected.

## PACKAGE MARKING AND ORDERING INFORMATION

Part Number	Top Mark	Package	Packing Methode	Reel Size	Tape Width	Quantity
R3060G2	ISL9R3060G2	TO-247-2L	Tube	N/A	N/A	30
R3060G2	ISL9R3060P2	TO-220AC-2L	Tube	N/A	N/A	50

## ELECTRICAL CHARACTERISTICS ( $T_C = 25^\circ\text{C}$ unless otherwise noted)

Symbol	Parameter	Test Conditions	Min.	Typ.	Max.	Unit
--------	-----------	-----------------	------	------	------	------

### OFF STATE CHARACTERISTICS

$I_R$	Instantaneous Reverse Current	$V_R = 600\text{ V}$	$T_C = 25^\circ\text{C}$	-	-	100	$\mu\text{A}$
			$T_C = 125^\circ\text{C}$	-	-	1	mA

### ON CHARACTERISTICS

$V_F$	Instantaneous Forward Voltage	$I_F = 30\text{ A}$	$T_C = 25^\circ\text{C}$	-	2.1	2.4	V
			$T_C = 125^\circ\text{C}$	-	1.7	2.1	V

### DYNAMIC CHARACTERISTICS

$C_J$	Junction Capacitance	$V_R = 10\text{ V}, I_F = 0\text{ A}$	-	120	-	pF
-------	----------------------	---------------------------------------	---	-----	---	----

### SWITCHING CHARACTERISTICS

$T_{rr}$	Reverse Recovery Time	$I_F = 1\text{ A}, di_F/dt = 100\text{ A}/\mu\text{s}, V_R = 30\text{ V}$	-	27	35	ns
			$I_F = 30\text{ A}, di_F/dt = 100\text{ A}/\mu\text{s}, V_R = 30\text{ V}$	-	36	45
$T_{rr}$	Reverse Recovery Time	$I_F = 30\text{ A}$ $di_F/dt = 200\text{ A}/\mu\text{s}$ $V_R = 390\text{ V}$ $T_C = 25^\circ\text{C}$	-	36	-	ns
$I_{RR}$	Reverse Recovery Current		-	2.9	-	A
$Q_{RR}$	Reverse Recovery Charge		-	55	-	nC
$T_{rr}$	Reverse Recovery Time	$I_F = 30\text{ A}$ $di_F/dt = 200\text{ A}/\mu\text{s}$ $V_R = 390\text{ V},$ $T_C = 125^\circ\text{C}$	-	110	-	ns
S	Softness Factor ( $t_p/t_a$ )		-	1.9	-	-
$I_{RR}$	Reverse Recovery Current		-	6	-	A
$Q_{RR}$	Reverse Recovery Charge		-	450	-	nC

## ISL9R3060G2, ISL9R3060P2

### ELECTRICAL CHARACTERISTICS ( $T_C = 25^\circ\text{C}$ unless otherwise noted) (continued)

Symbol	Parameter	Test Conditions	Min.	Typ.	Max.	Unit
--------	-----------	-----------------	------	------	------	------

#### SWITCHING CHARACTERISTICS

$T_{rr}$	Reverse Recovery Time	$I_F = 30\text{ A}$ $di_F/dt = 1000\text{ A}/\mu\text{s}$ $V_R = 390\text{ V}$ $T_C = 125^\circ\text{C}$	–	60	–	ns
S	Softness Factor ( $t_b/t_a$ )		–	1.25	–	–
$I_{RR}$	Reverse Recovery Current		–	21	–	A
$Q_{RR}$	Reverse Recovery Charge		–	730	–	nC
$di_M/dt$	Maximum $di/dt$ during $t_b$		–	800	–	A/ $\mu\text{s}$

#### THERMAL CHARACTERISTICS

$R_{\theta JC}$	Thermal Resistance Junction to Case		–	–	0.75	$^\circ\text{C}/\text{W}$
$R_{\theta JA}$	Thermal Resistance Junction to Ambient	TO-247	–	–	30	$^\circ\text{C}/\text{W}$
$R_{\theta JA}$	Thermal Resistance Junction to Ambient	TO-220	–	–	62	$^\circ\text{C}/\text{W}$

Product parametric performance is indicated in the Electrical Characteristics for the listed test conditions, unless otherwise noted. Product performance may not be indicated by the Electrical Characteristics if operated under different conditions.

TYPICAL PERFORMANCE CURVES

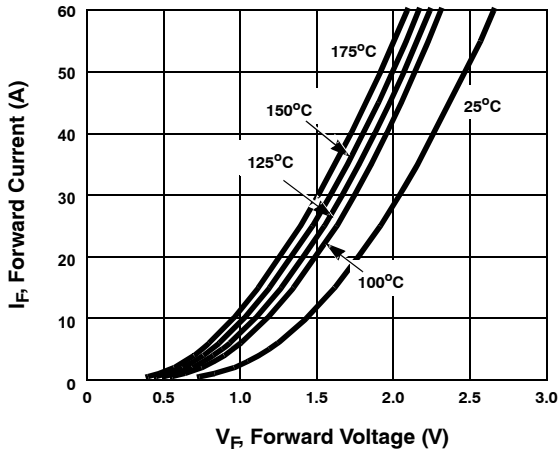

Figure 1. Forward Current vs. Forward Voltage

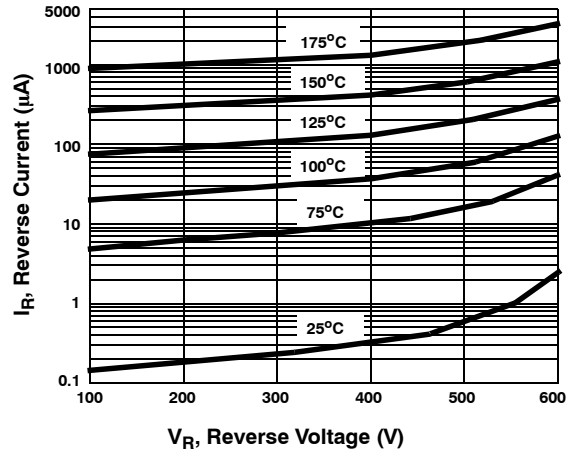

Figure 2. Reverse Current vs. Reverse Voltage

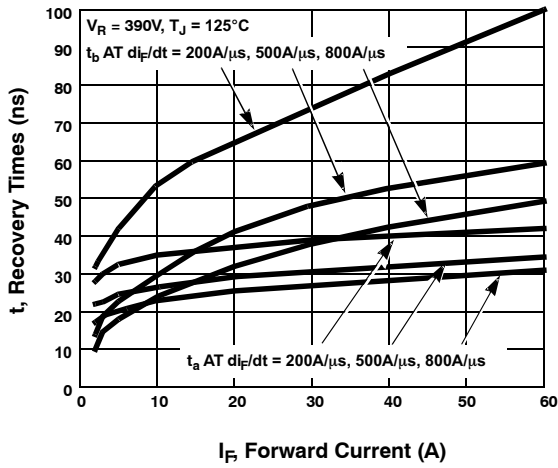

Figure 3.  $t_a$  and  $t_b$  Curves vs. Forward Current

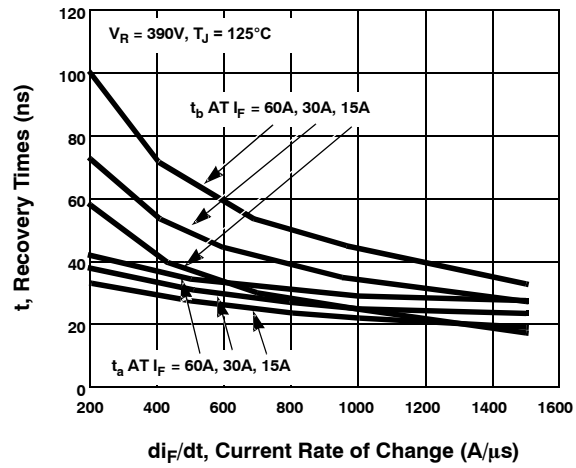

Figure 4.  $t_a$  and  $t_b$  Curves vs.  $di_F/dt$

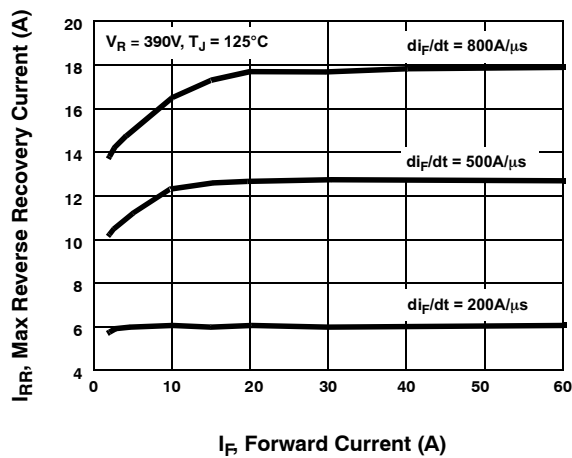

Figure 5. Maximum Reverse Recovery Current vs. Forward Current

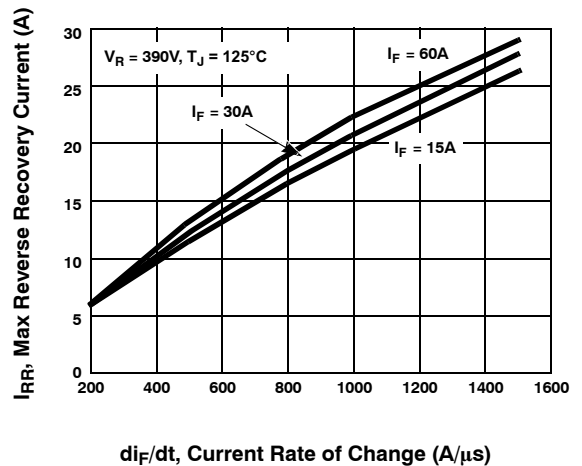

Figure 6. Maximum Reverse Recovery Current vs.  $di_F/dt$

# ISL9R3060G2, ISL9R3060P2

## TYPICAL PERFORMANCE CURVES

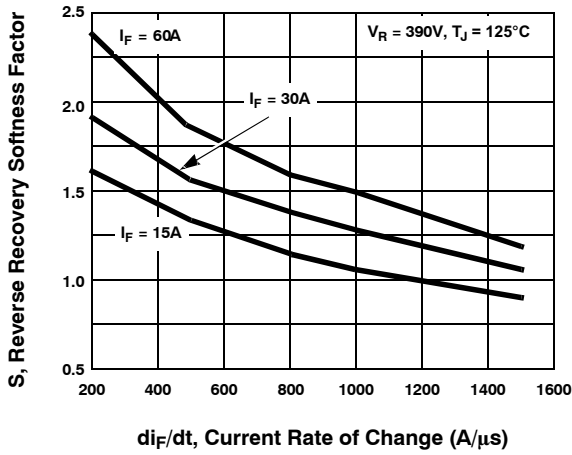

Figure 7. Reverse Recovery Softness Factor vs.  $di_F/dt$

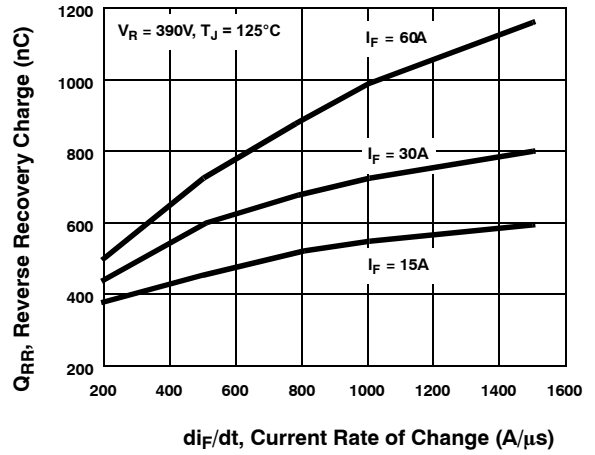

Figure 8. Reverse Recovery Charge vs.  $di_F/dt$

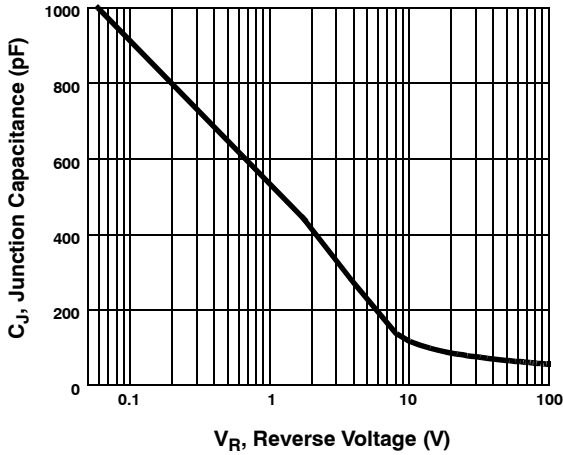

Figure 9. Junction Capacitance vs. Reverse Voltage

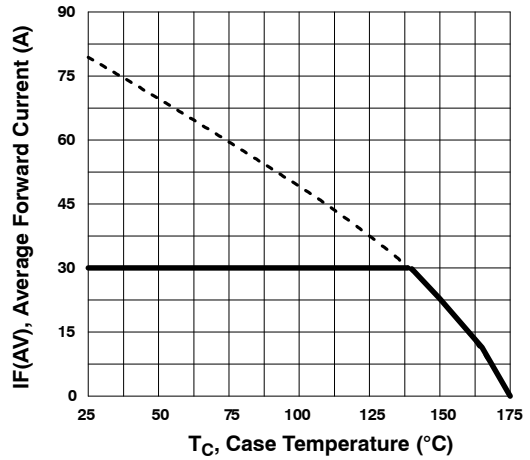

Figure 10. Forward Current Derating Curve

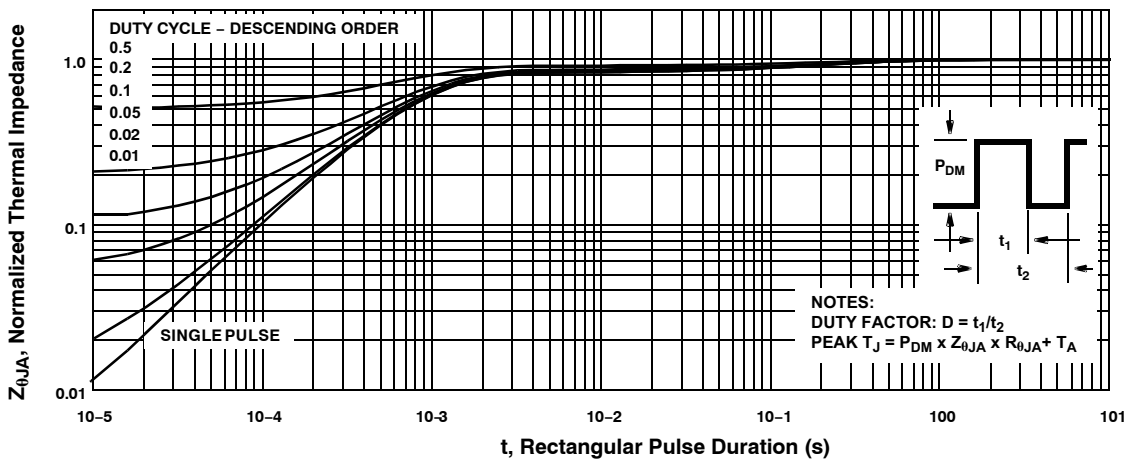

Figure 11. Normalized Maximum Transient Thermal Impedance

TEST CIRCUITS AND WAVEFORMS

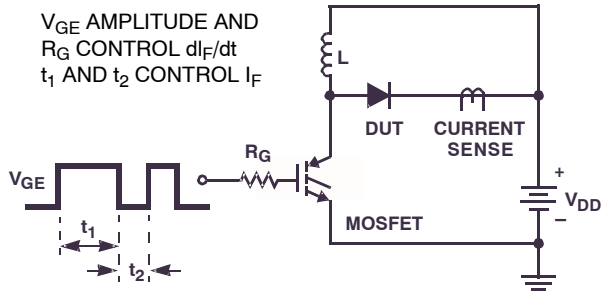

Figure 12.  $T_{rr}$  Test Circuit

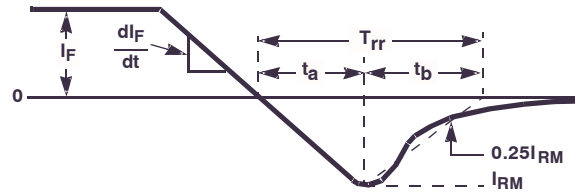

Figure 13.  $T_{rr}$  Waveforms and Definitions

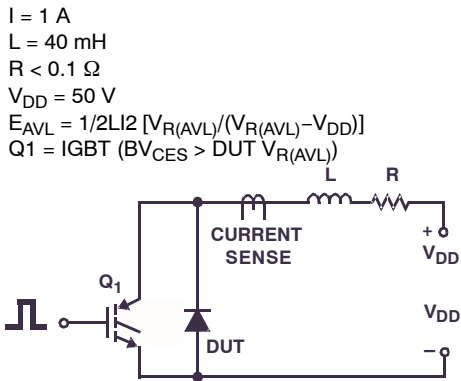

Figure 14. Avalanche Energy Test Circuit

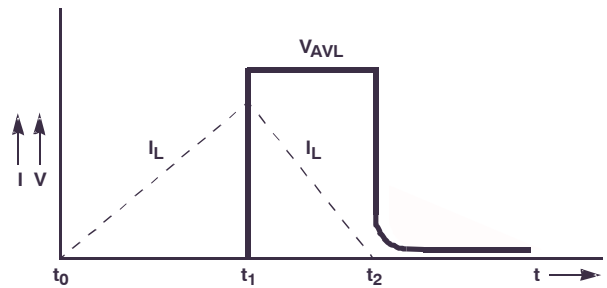

Figure 15. Avalanche Current and Voltage Waveforms

# MECHANICAL CASE OUTLINE

## PACKAGE DIMENSIONS

ON Semiconductor®



TO-220-2LD  
CASE 340BA  
ISSUE O

DATE 31 AUG 2016

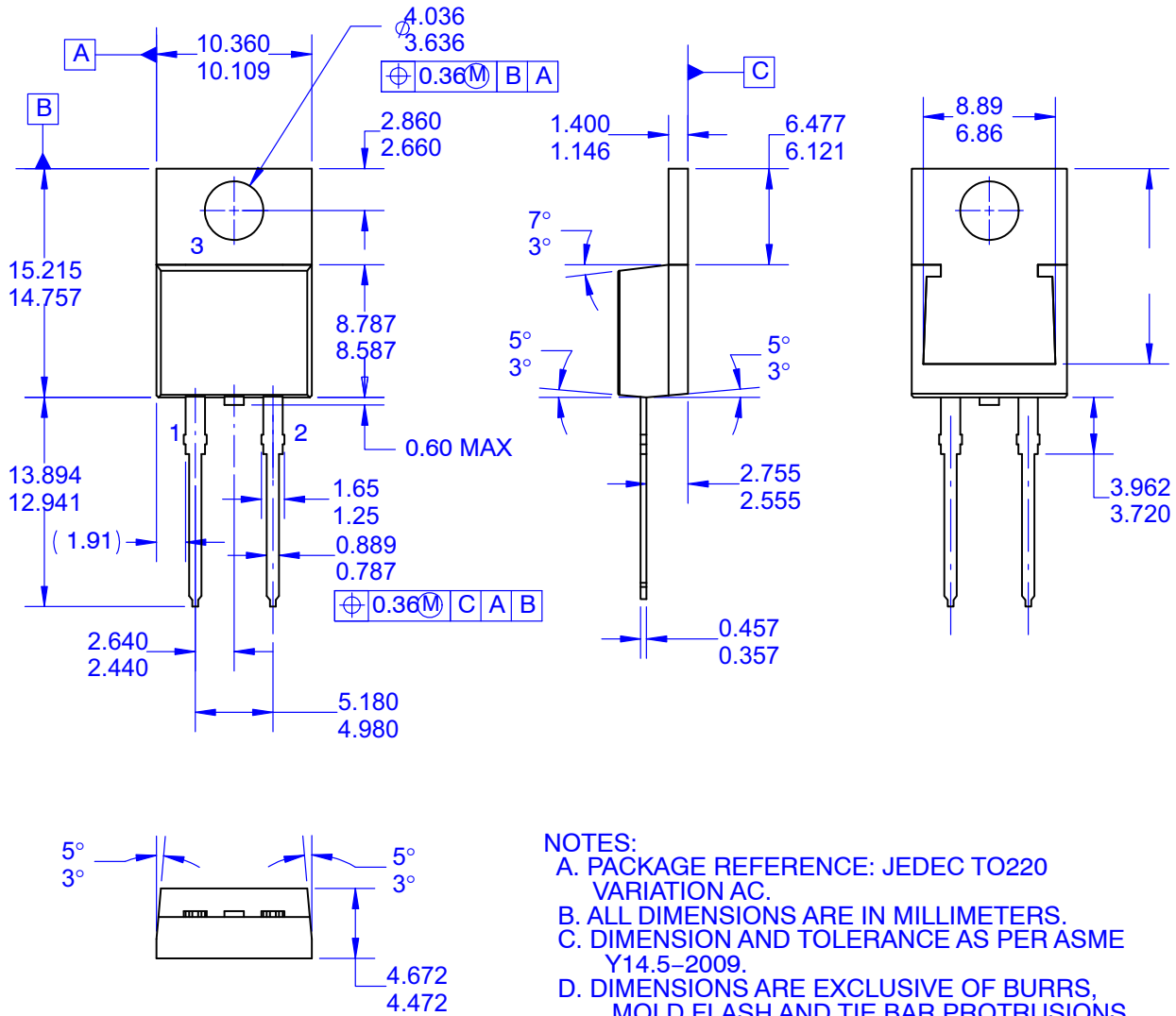

- NOTES:
- A. PACKAGE REFERENCE: JEDEC TO220 VARIATION AC.
  - B. ALL DIMENSIONS ARE IN MILLIMETERS.
  - C. DIMENSION AND TOLERANCE AS PER ASME Y14.5-2009.
  - D. DIMENSIONS ARE EXCLUSIVE OF BURRS, MOLD FLASH AND TIE BAR PROTRUSIONS.

<b>DOCUMENT NUMBER:</b>	<b>98AON13831G</b>	Electronic versions are uncontrolled except when accessed directly from the Document Repository. Printed versions are uncontrolled except when stamped "CONTROLLED COPY" in red.
<b>DESCRIPTION:</b>	<b>TO-220-2LD</b>	<b>PAGE 1 OF 1</b>

ON Semiconductor and are trademarks of Semiconductor Components Industries, LLC dba ON Semiconductor or its subsidiaries in the United States and/or other countries. ON Semiconductor reserves the right to make changes without further notice to any products herein. ON Semiconductor makes no warranty, representation or guarantee regarding the suitability of its products for any particular purpose, nor does ON Semiconductor assume any liability arising out of the application or use of any product or circuit, and specifically disclaims any and all liability, including without limitation special, consequential or incidental damages. ON Semiconductor does not convey any license under its patent rights nor the rights of others.

# MECHANICAL CASE OUTLINE

## PACKAGE DIMENSIONS

ON Semiconductor®



TO-247-2LD  
CASE 340CL  
ISSUE A

DATE 03 DEC 2019

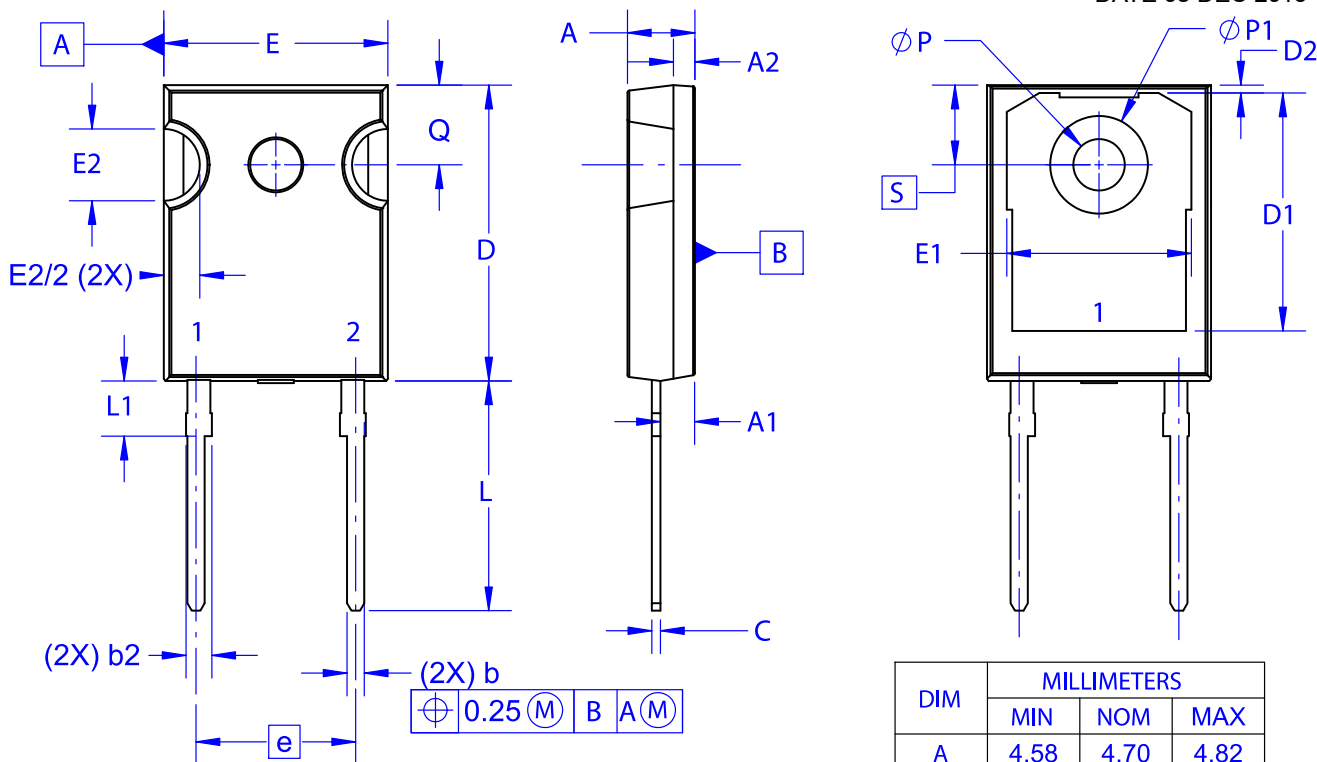

$\oplus 0.25 (M) B A (M)$

NOTES: UNLESS OTHERWISE SPECIFIED.

- A. DIMENSIONS ARE EXCLUSIVE OF BURRS, MOLD FLASH, AND TIE BAR EXTRUSIONS.
- B. ALL DIMENSIONS ARE IN MILLIMETERS.
- C. DRAWING CONFORMS TO ASME Y14.5 - 2009.
- D. DIMENSION A1 TO BE MEASURED IN THE REGION DEFINED BY L1.
- E. LEAD FINISH IS UNCONTROLLED IN THE REGION DEFINED BY L1.

### GENERIC MARKING DIAGRAM\*

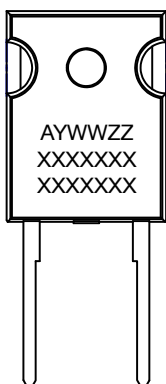

XXXX = Specific Device Code  
A = Assembly Location  
Y = Year  
WW = Work Week  
ZZ = Assembly Lot Code

\*This information is generic. Please refer to device data sheet for actual part marking. Pb-Free indicator, "G" or microdot "•", may or may not be present. Some products may not follow the Generic Marking.

DIM	MILLIMETERS		
	MIN	NOM	MAX
A	4.58	4.70	4.82
A1	2.29	2.40	2.66
A2	1.30	1.50	1.70
b	1.17	1.26	1.35
b2	1.53	1.65	1.77
c	0.51	0.61	0.71
D	20.32	20.57	20.82
D1	16.37	16.57	16.77
D2	0.51	0.93	1.35
E	15.37	15.62	15.87
E1	12.81	~	~
E2	4.96	5.08	5.20
e	~	11.12	~
L	15.75	16.00	16.25
L1	3.69	3.81	3.93
∅P	3.51	3.58	3.65
∅P1	6.61	6.73	6.85
Q	5.34	5.46	5.58
S	5.34	5.46	5.58

DOCUMENT NUMBER:	98AON13850G	Electronic versions are uncontrolled except when accessed directly from the Document Repository. Printed versions are uncontrolled except when stamped "CONTROLLED COPY" in red.
DESCRIPTION:	TO-247-2LD	PAGE 1 OF 1

ON Semiconductor and are trademarks of Semiconductor Components Industries, LLC dba ON Semiconductor or its subsidiaries in the United States and/or other countries. ON Semiconductor reserves the right to make changes without further notice to any products herein. ON Semiconductor makes no warranty, representation or guarantee regarding the suitability of its products for any particular purpose, nor does ON Semiconductor assume any liability arising out of the application or use of any product or circuit, and specifically disclaims any and all liability, including without limitation special, consequential or incidental damages. ON Semiconductor does not convey any license under its patent rights nor the rights of others.



**onsemi**, **Onsemi**, and other names, marks, and brands are registered and/or common law trademarks of Semiconductor Components Industries, LLC dba "**onsemi**" or its affiliates and/or subsidiaries in the United States and/or other countries. **onsemi** owns the rights to a number of patents, trademarks, copyrights, trade secrets, and other intellectual property. A listing of **onsemi**'s product/patent coverage may be accessed at [www.onsemi.com/site/pdf/Patent-Marking.pdf](http://www.onsemi.com/site/pdf/Patent-Marking.pdf). **onsemi** reserves the right to make changes at any time to any products or information herein, without notice. The information herein is provided "as-is" and **onsemi** makes no warranty, representation or guarantee regarding the accuracy of the information, product features, availability, functionality, or suitability of its products for any particular purpose, nor does **onsemi** assume any liability arising out of the application or use of any product or circuit, and specifically disclaims any and all liability, including without limitation special, consequential or incidental damages. Buyer is responsible for its products and applications using **onsemi** products, including compliance with all laws, regulations and safety requirements or standards, regardless of any support or applications information provided by **onsemi**. "Typical" parameters which may be provided in **onsemi** data sheets and/or specifications can and do vary in different applications and actual performance may vary over time. All operating parameters, including "Typicals" must be validated for each customer application by customer's technical experts. **onsemi** does not convey any license under any of its intellectual property rights nor the rights of others. **onsemi** products are not designed, intended, or authorized for use as a critical component in life support systems or any FDA Class 3 medical devices or medical devices with a same or similar classification in a foreign jurisdiction or any devices intended for implantation in the human body. Should Buyer purchase or use **onsemi** products for any such unintended or unauthorized application, Buyer shall indemnify and hold **onsemi** and its officers, employees, subsidiaries, affiliates, and distributors harmless against all claims, costs, damages, and expenses, and reasonable attorney fees arising out of, directly or indirectly, any claim of personal injury or death associated with such unintended or unauthorized use, even if such claim alleges that **onsemi** was negligent regarding the design or manufacture of the part. **onsemi** is an Equal Opportunity/Affirmative Action Employer. This literature is subject to all applicable copyright laws and is not for resale in any manner.

## PUBLICATION ORDERING INFORMATION

### LITERATURE FULFILLMENT:

Email Requests to: [orderlit@onsemi.com](mailto:orderlit@onsemi.com)

**onsemi Website:** [www.onsemi.com](http://www.onsemi.com)

### TECHNICAL SUPPORT

**North American Technical Support:**  
Voice Mail: 1 800-282-9855 Toll Free USA/Canada  
Phone: 011 421 33 790 2910

**Europe, Middle East and Africa Technical Support:**

Phone: 00421 33 790 2910

For additional information, please contact your local Sales Representative