

NOTES:

1. Material : Spring Steel
2. Finish : Glod Irridite
3. Ends : Closed and Ground
4. Total Coils : 10.000
5. Sugg. Max. Deflection : 0.350 (in)
6. Sugg. Max. Load : 2.300 (lbs)
7. All Drawing Dimensions are in Inches [mm]

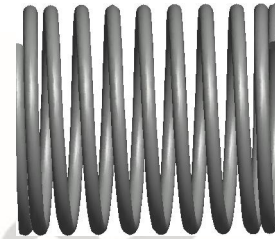

∅ 0.030
[0,76]
WIRE DIA

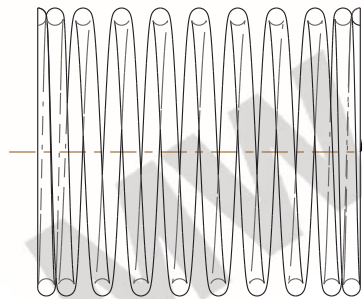

GROUND
SURFACE

1.910
[48,51]
LENGTH

∅ 0.500
[12,70]
O.D

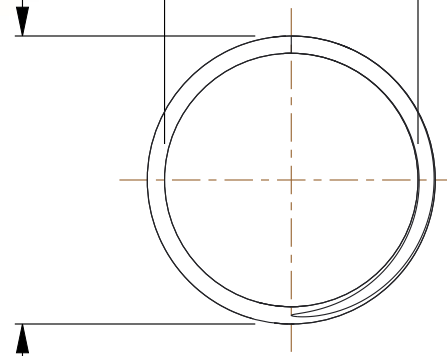

∅ 0.440
[11,18]
I.D

COMPONENT		SPRINGS	
<p>11772</p> <p>COMPRESSION SPRINGS</p>		UNIT	
		INCH [mm]	
		SHEET	
		1 of 1	