

**AP1156ADSXX****Negative Input / Output Voltage LDO Regulator****1. General Description**

AP1156ADS series is a negative-input negative-output regulator IC using silicon monolithic bipolar structure which can supply 150mA output current. The output voltage can be set from -1.3 to -1.5V, which is trimmed in high accuracy. AP1156ADS is supplied with ON/OFF terminal and noise reduction terminal. The ON/OFF control can be controlled directly with positive logic or CPU. The over current, thermal and reverse bias protections are integrated.

2. Features

- Available to use a small 1.0 μ F ceramic capacitor
- Dropout Voltage $V_{DROD}=160\text{mV}$ at 100mA
- Output Current 150mA
- High Precision output voltage $\pm 2.0\%$ or $\pm 60\text{mV}$
- Wide operating voltage range -2.8V to -17.0V
- Very low quiescent current $I_{QUT}=155\mu\text{A}$ at $I_{OUT}=0\text{mA}$
- On/Off control (High active)
- Built-in Short circuit protection, thermal shutdown
- Built-in reverse bias over current protection
- Available very low noise application
- Very small surface mount package SOT23-5

3. Applications

- Battery Powered Systems
- DSC, CCD bias, GaAs bias

4. Table of Contents

1. General Description	1
2. Features	1
3. Applications	1
4. Table of Contents	2
5. Block Diagram	3
6. Ordering Information	4
7. Pin Configurations and Functions.....	4
8. Absolute Maximum Ratings	5
9. Recommended Operating Conditions	5
10. Electrical Characteristics.....	6
■ Electrical Characteristics (Ta=Tj=25°C).....	6
■ Electrical Characteristics (Ta=-40°C~85°C)	7
11. Description	8
11.1 DC Characteristics	8
11.2 Temperature Characteristic.....	10
11.3 Load Transient	12
11.4 ON/OFF Transient	13
11.5 Line Transient.....	14
11.6 Ripple Rejection	16
11.7 ESR Stability.....	18
11.8 Operating Region and Power Dissipation.....	19
11.9 Application hint	20
12. Definition of term.....	21
13. Test Circuit.....	22
■ Test Circuit.....	22
14. Package.....	23
■ Outline Dimensions.....	23
15. Revise History	24
IMPORTANT NOTICE	25

5. Block Diagram

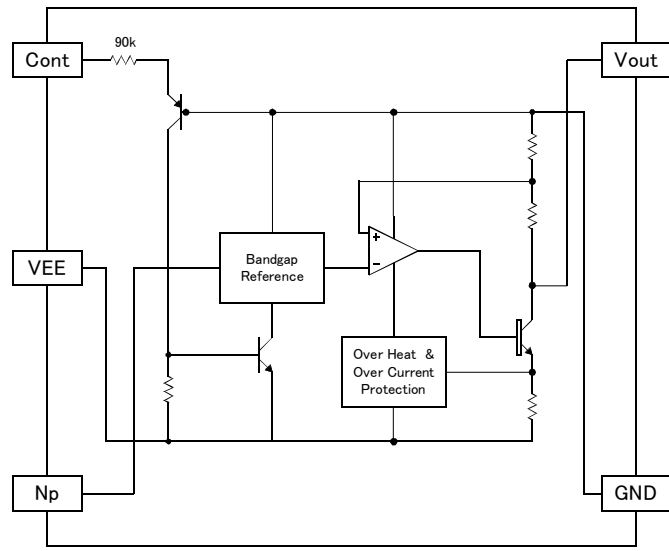

Control:High Level On

Figure 1. Block Diagram

6. Ordering Information

AP1156ADSXX -40 to 85°C SOT23-5

- Output Voltage Code

For product name, please check the below chart. Please contact your authorized ASAHI KASEI MICRODEVICES representative for voltage availability.

AP1156ADSXX

└─── Output voltage code

Table 1. Standard Voltage Version, Output Voltage & Voltage Code

XX	V _{OUT}
13	-1.3
15	-1.5

Table 2. Optional Voltage Version, Output Voltage & Voltage Code

XX	V _{OUT}
14	-1.4

7. Pin Configurations and Functions

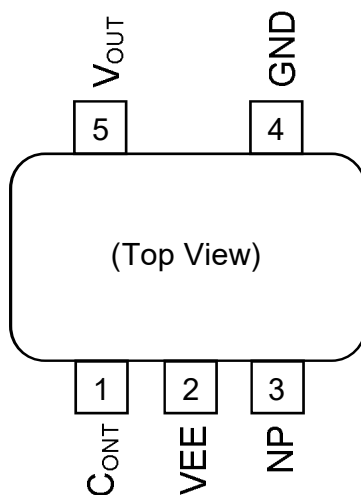

8. Absolute Maximum Ratings

Parameter	Symbol	min	max	Unit	Condition
Supply Voltage	V _{in}	-20	0.4	V	V _{in} + V _{cont} ≤20V
Cont Terminal Voltage	V _{cont}	-0.4	5	V	V _{in} + V _{cont} ≤19V
Reverse Bias Voltage	V _{rev}	-20	0.3	V	V _{in} -V _{out} ≤0.3V
Power Dissipation	P _D	-	500	mW	(Note 1)
Junction temperature	T _j	-	150	°C	
Storage Temperature Range	T _{STG}	-55	150	°C	

Note 1. P_D must be decreased at the rate of 4.0mW/°C for operation above 25°C.

WARNING: The maximum ratings are the absolute limitation values with the possibility of the IC breakage. When the operation exceeds this standard quality cannot be guaranteed.

9. Recommended Operating Conditions

Parameter	Symbol	min	typ	max	Unit	Condition
Operating Temperature Range	T _a	-40	-	85	°C	
Operating Voltage Range	V _{OP}	-17	-	-2.8	V	V _{in} + V _{cont} ≤19V,

10. Electrical Characteristics

■ Electrical Characteristics (Ta=Tj=25°C)

The parameters with min or max values will be guaranteed at Ta=Tj=25°C.

(Vin=-3.7V, Ta=Tj=25°C)

Parameter	Symbol	Condition	min	typ	max	Unit
Vout	Vout	Iout=5mA	(Table 1)			V
Line Regulation	LinReg	$\Delta V_{in}=5V$	-	1	5	mV
Load Regulation	LoaReg	Iout=5mA~50mA	(Table 1)			mV
		Iout=5mA~100mA				
		Iout=5mA~150mA				
Quiescent Current	Iq	Iout=0mA	-	155	250	μA
Standby Current	Istandby	Vout Off State	-	0	1	μA
Peak Output Current	Iout _{MAX}	When Vout drops 10%	200	280	-	mA
Short Circuit Current	IShort		-	300	-	mA
Cont Terminal Current	Icont	Vcont=+1.8V	-	12	30	μA
Cont Terminal Voltage	Vcont	Vout ON State	1.3	-	-	V
		Vout OFF State	-	-	0.3	V

Table 1. Standard Voltage Version

Part Number	Vout			LoaReg					
				Iout=50mA		Iout=100mA		Iout=150mA	
	min	typ	max	typ	max	typ	max	typ	max
AP1156ADS13	-1.360	-1.300	-1.240	4	15	8	20	22	50
AP1156ADS15	-1.560	-1.500	-1.440	4	15	8	20	22	50

Table 2. Optional Voltage Version

Part Number	Vout			LoaReg					
				Iout=50mA		Iout=100mA		Iout=150mA	
	min	typ	max	typ	max	typ	max	typ	max
AP1156ADS14	-1.460	-1.400	-1.340	4	15	8	20	22	50

■ Electrical Characteristics (Ta=-40°C~85°C)

The parameters with min or max values will be guaranteed at Ta=-40 ~ 85°C.

(Vin=-3.7V, Ta=-40 ~ 85°C)

Parameter	Symbol	Condition	min	typ	Max	Unit
Vout	Vout	Iout=5mA	(Table 3, Table 4)			V
Line Regulation	LinReg	$\Delta V_{in}=5V$	-	1	8	mV
Load Regulation	LoaReg	Iout=5mA~50mA	(Table 3, Table 4)			mV
		Iout=5mA~100mA				mV
		Iout=5mA~150mA				mV
Supply Current	Icc	Iout=0mA	-	155	300	μA
Standby Current	Istandby	Vout Off State	-	0	5	μA
Peak Output Current	Iout _{MAX}	When Vout drops 10%	185	280	-	mA
Short Circuit Current	I _{Short}		-	300	-	mA
Vcont Terminal Current	Icont	Vcont=+1.8V	-	12	30	μA
Vcont Terminal Voltage	Vcont	Vout ON State	1.3	-	-	V
		Vout OFF State	-	-	0.3	V

Table 3. Standard Voltage Version

Part Number	Vout			LoaReg					
				Iout=50mA		Iout=100mA		Iout=150mA	
	min	typ	max	typ	max	typ	max	typ	max
AP1156ADS13	-1.390	-1.300	-1.210	4	16	8	22	22	72
AP1156ADS15	-1.590	-1.500	-1.410	4	16	8	22	22	72

Table 4. Optional Voltage Version

Part Number	Vout			LoaReg					
				Iout=50mA		Iout=100mA		Iout=150mA	
	min	typ	max	typ	max	typ	max	typ	max
AP1156ADS14	-1.490	-1.400	-1.310	4	16	8	22	22	72

11. Description

11.1 DC Characteristics

Unless otherwise specified $V_{in} = -3.5V$, $V_{cont} = 1.5V$, $C_{in} = 1.0\mu F$ (MLCC), $C_{out} = 1.0\mu F$ (MLCC), $C_{np} = 0.01\mu F$
 $T_a = 25^\circ C$

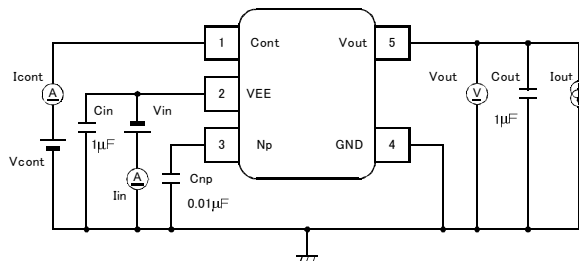

■ I_{gnd}

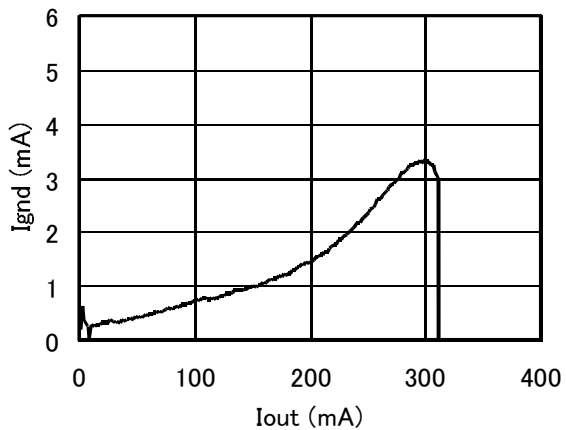

■ I_{in} ($I_{out} = 0mA$)

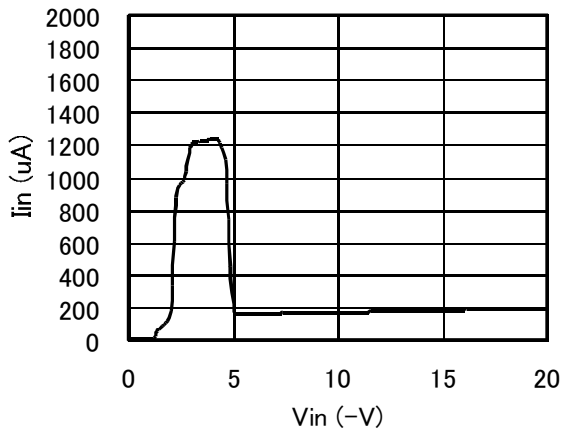

■ Dropout Voltage

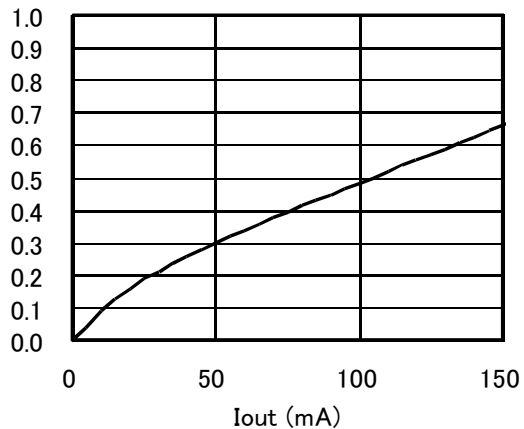

■ Icont VS Vcont (Iout=1mA)

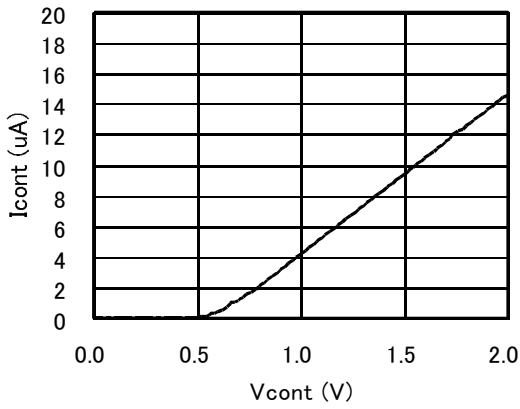

■ Icc Off Mode (Vcont=1.5V, Iout=0mA)

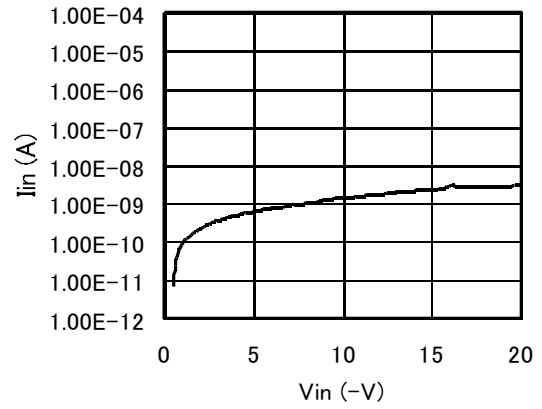

■ Iin (Iout=0mA) (Enlargement)

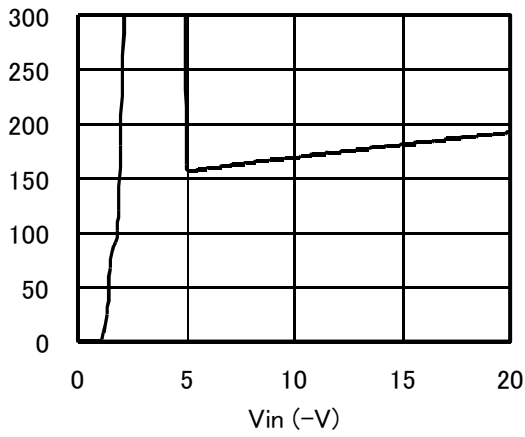

■ IQ (Enlargement)

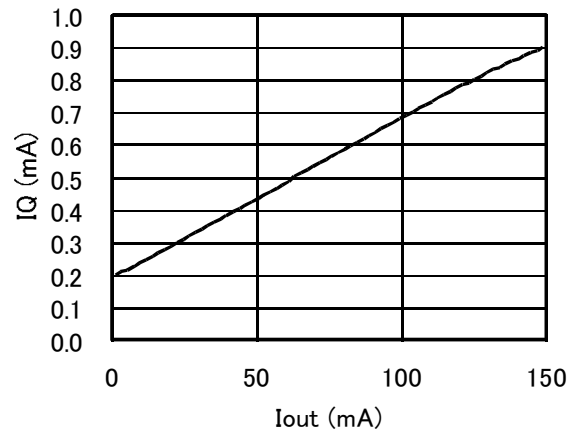

11.2 Temperature Characteristic

Unless otherwise specified $V_{in}=-3.5V$, $V_{cont}=1.5V$, $C_{in}=1.0\mu F(MLCC)$, $C_{out}=1.0\mu F(MLCC)$, $C_{np}=0.01\mu F$

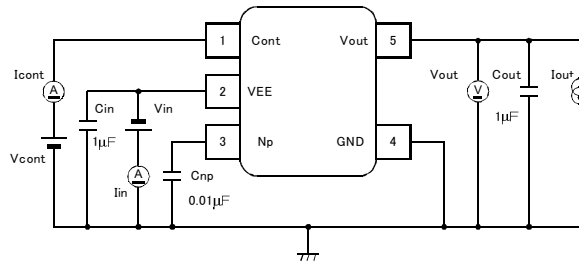

Vref

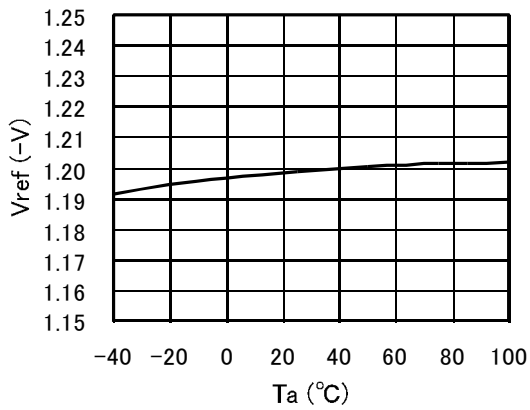

IoutMAX (Iout Nonpulse)

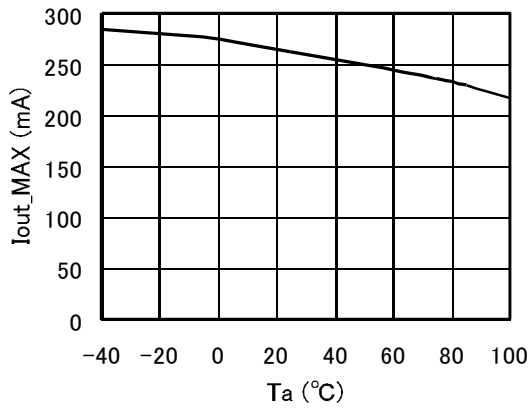

IoutMAX (Iout Pulse)

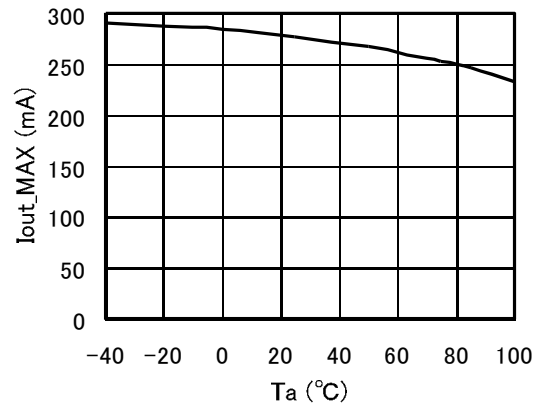

LoadReg

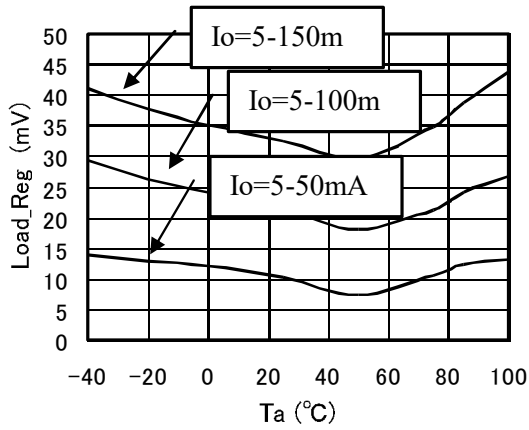

ON/OFF

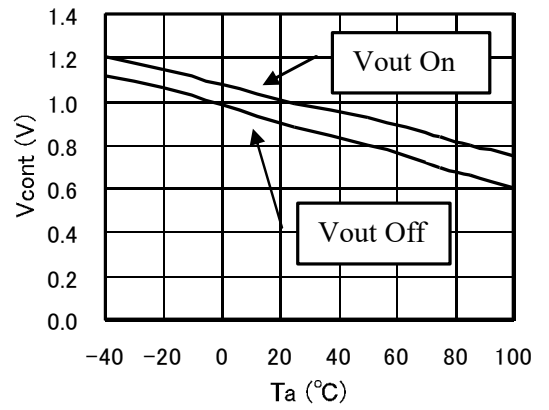

Iin(Iout=0mA)

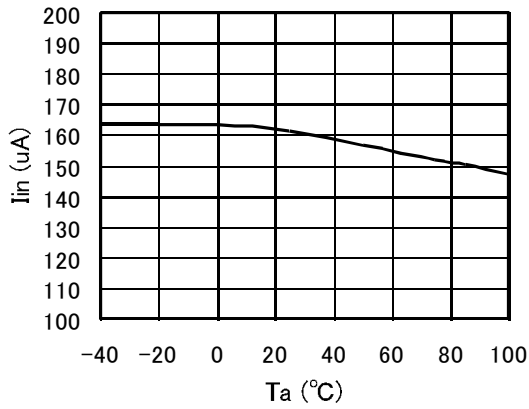

Icont

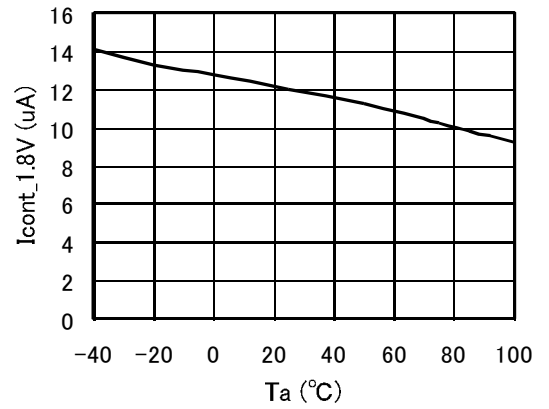

Icc OFFMode

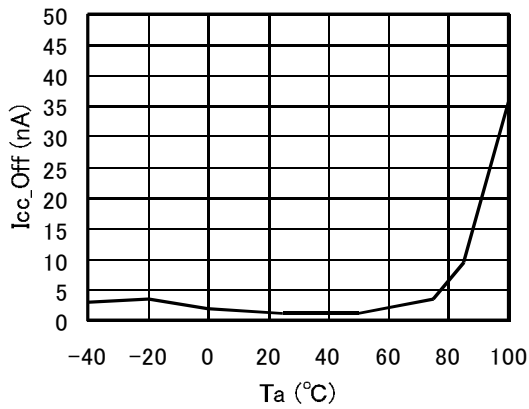

Vdrop

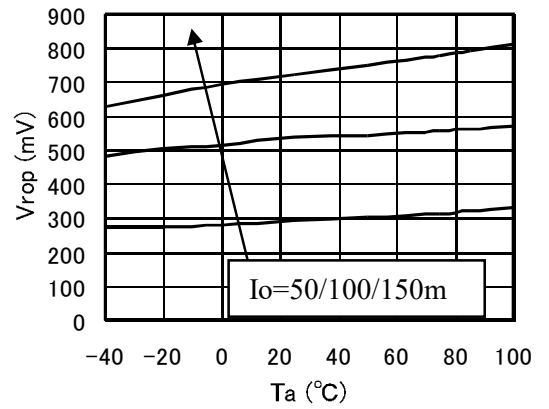

11.3 Load Transient

Unless otherwise specified $V_{in} = V_{out}(typ) - 1.5V$, $V_{cont} = 1.5V$, $C_{in} = 1.0\mu F(MLCC)$, $C_{np} = 0.01\mu F$

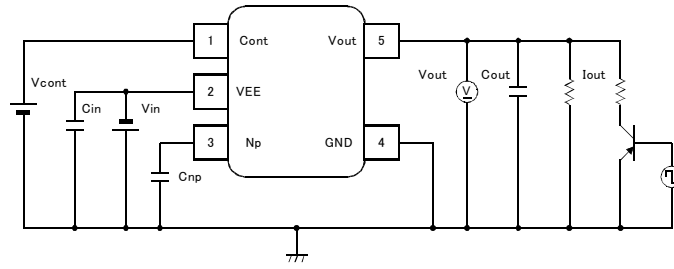

■ $I_{out} = 5 \rightarrow 100mA$

■ $I_{out} = 0 \rightarrow 100mA$

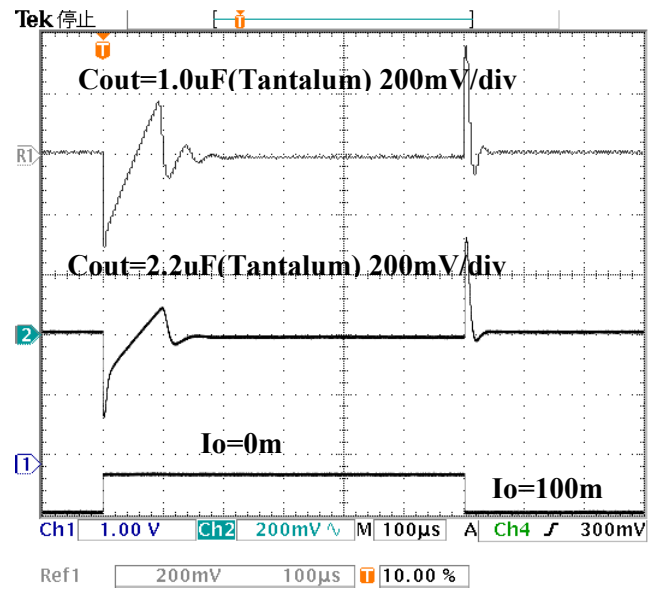
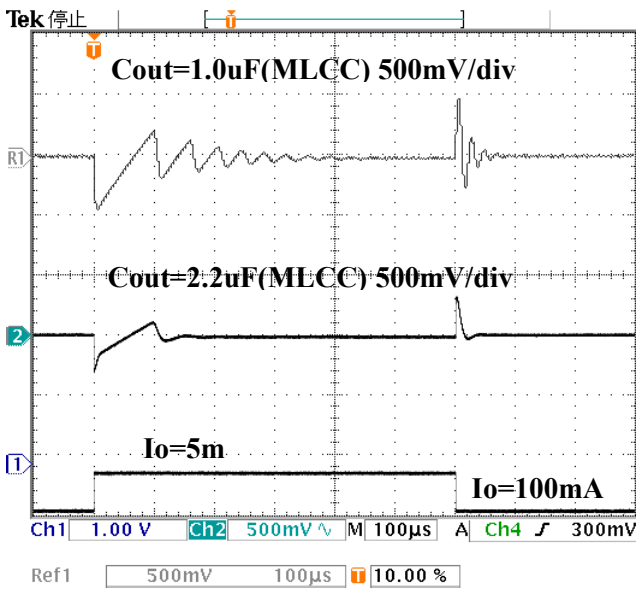

11.4 ON/OFF Transient

$V_{in} = -3.5V$, $C_{in} = 1.0\mu F$ (MLCC), $C_{np} = 0.01\mu F$, $I_{out} = 100mA$, Control $f = 1Hz$ (C_{np} Full discharge)

ON Transient Cnp Variable

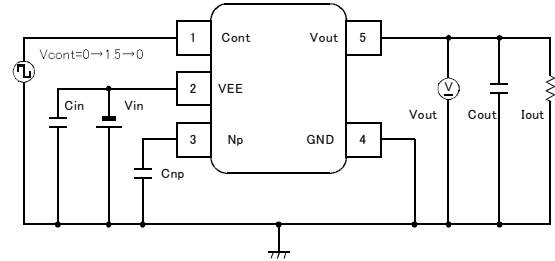
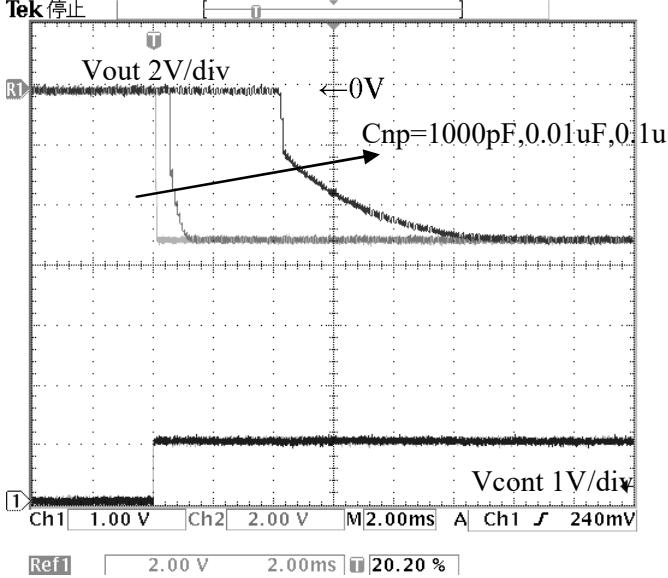

ON Transient Cout Variable

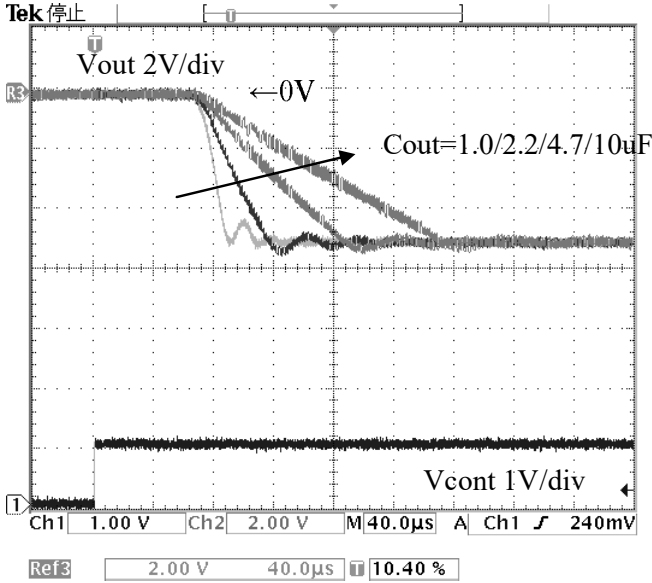

OFF Transient Cnp Variable

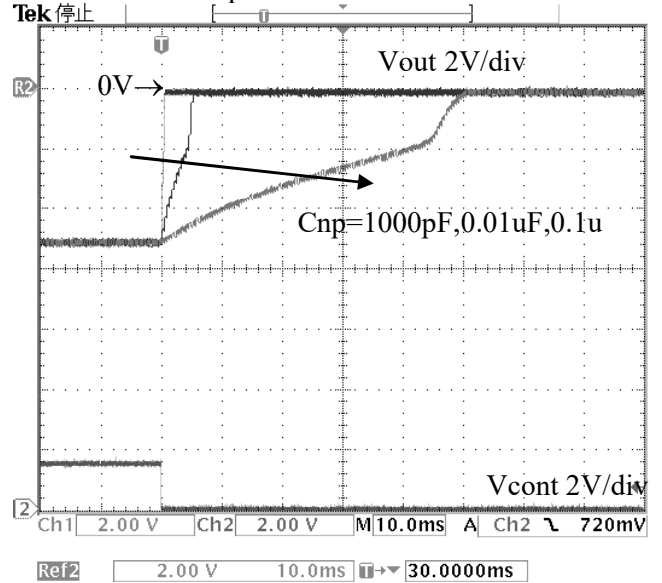

11.5 Line Transient

$V_{in} = -V_{out}(typ) - 1.5 \rightarrow -V_{out}(typ) - 2.5V$, $V_{cont} = 1.5V$, $C_{in} = 1.0\mu F(MLCC)$, $C_{np} = 0.01\mu F$, $I_{out} = 100mA$

■ $C_{in} = 1.0\mu F(MLCC)$ $I_{out} = 5mA$

■ $C_{in} = 1.0\mu F(MLCC)$ $I_{out} = 100mA$

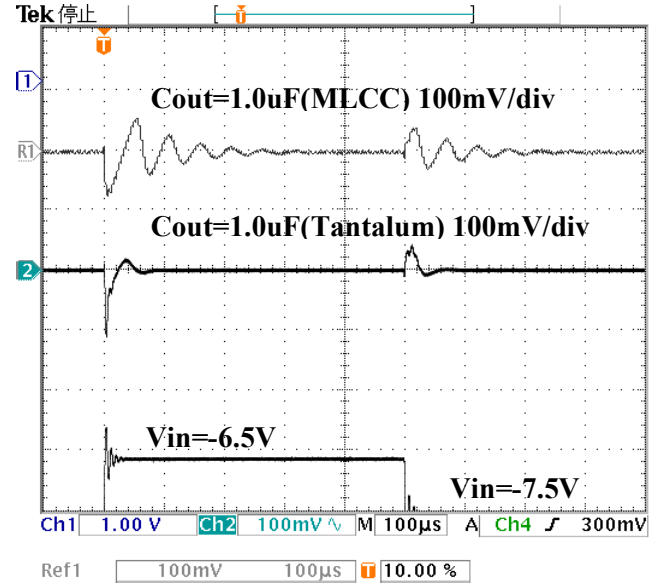
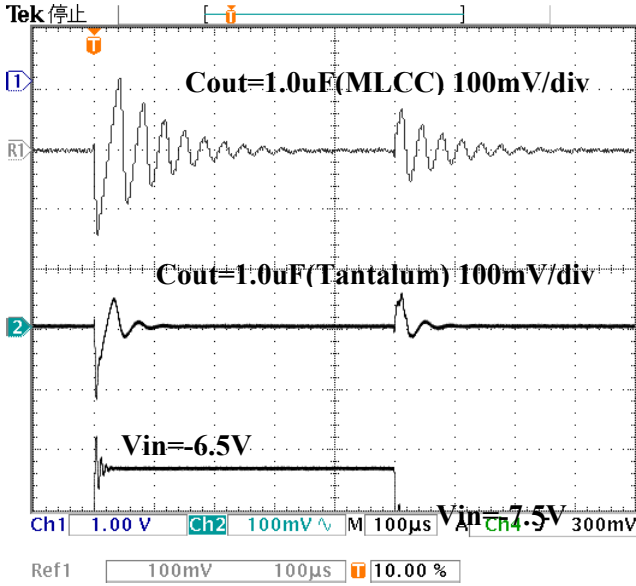

■ $C_{in} = 1.0\mu F(MLCC)$ $I_{out} = 5mA$

■ $C_{in} = 1.0\mu F(MLCC)$ $I_{out} = 100mA$

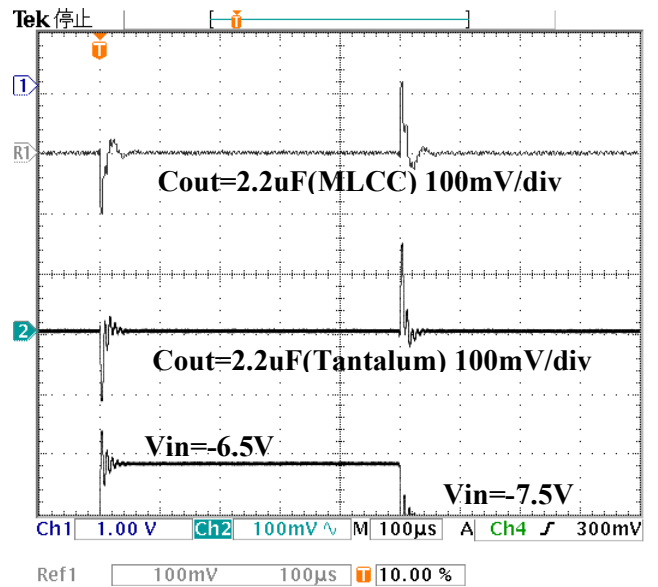
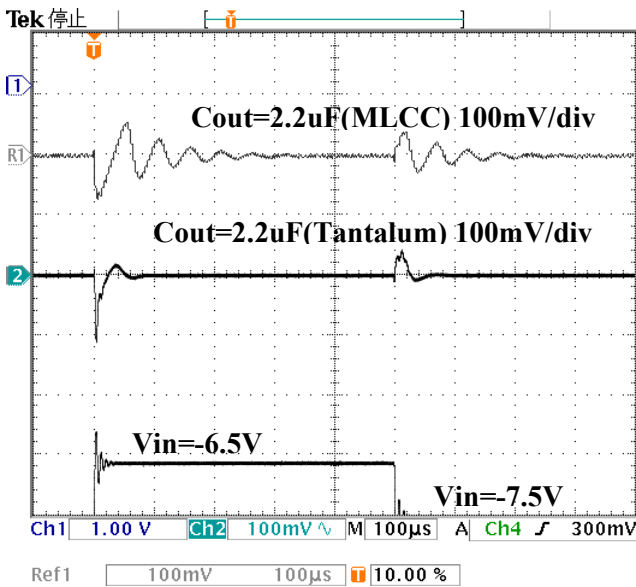

■Cin=1.0uF(Tantalum) Iout=5mA

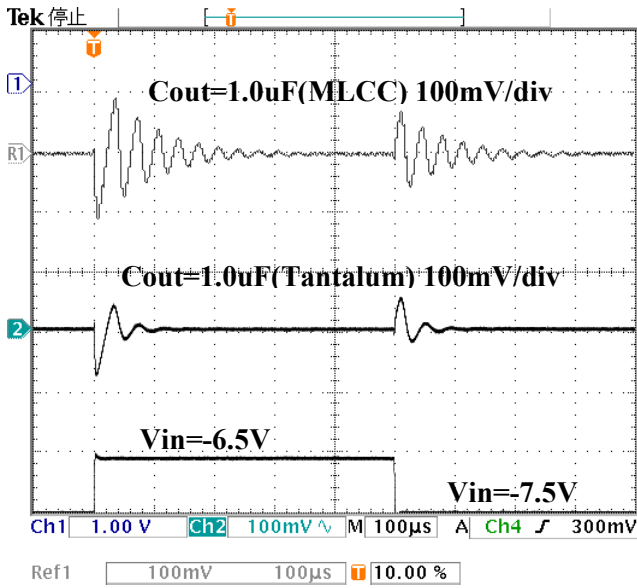

■Cin=1.0uF(Tantalum) Iout=100mA

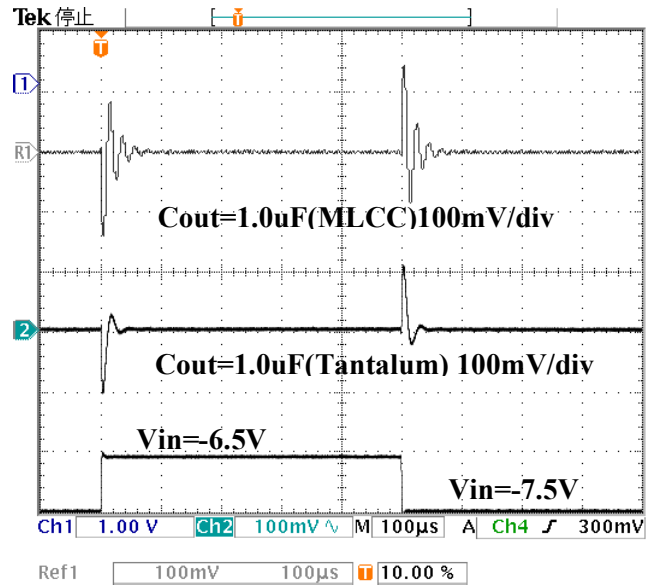

■Cin=1.0uF(Tantalum) Iout=5mA

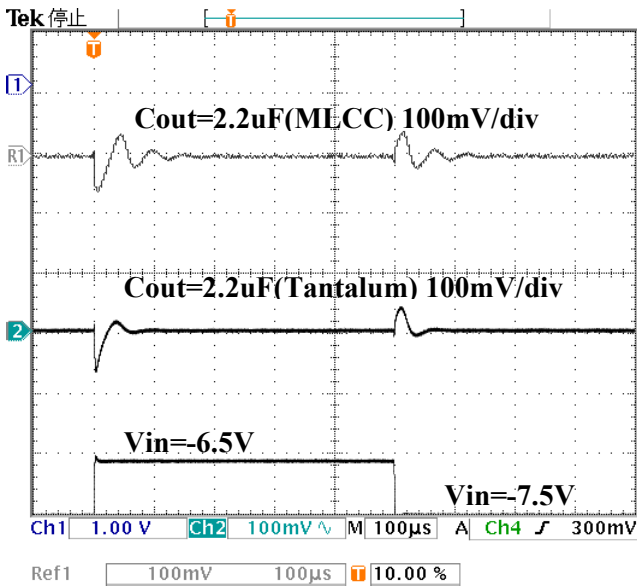

■Cin=1.0uF(Tantalum) Iout=100mA

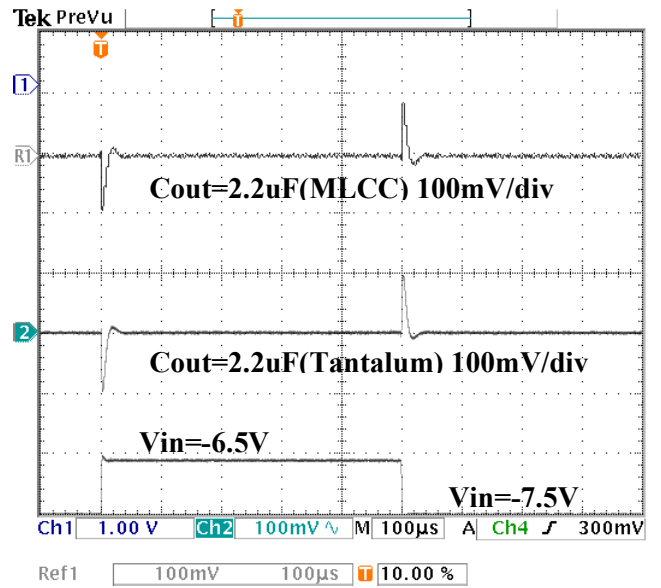

11.6 Ripple Rejection

$V_{in} = -3.5(V)$ $V_{cont} = 1.5V$, $V_{ripple} = 500mV_{p-p}$, $C_{np} = 0.01\mu F$, $I_{out} = 10mA$

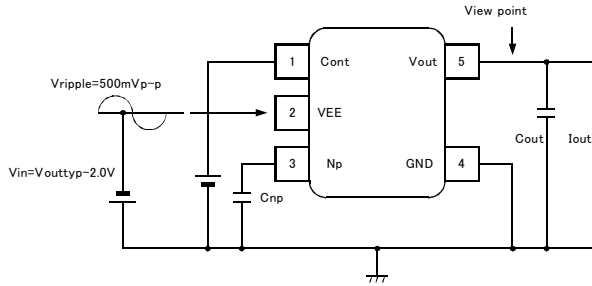

■ $C_{out} = 1.0\mu F$ (Tantalum), $I_{out} = 5mA$

■ $C_{out} = 1.0\mu F$ (MLCC), $I_{out} = 5mA$

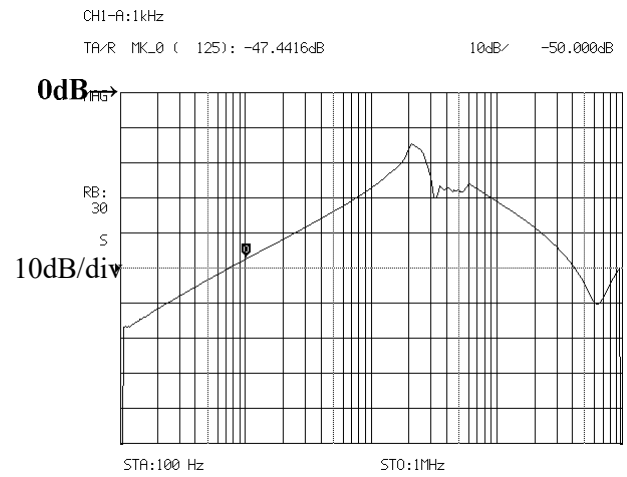
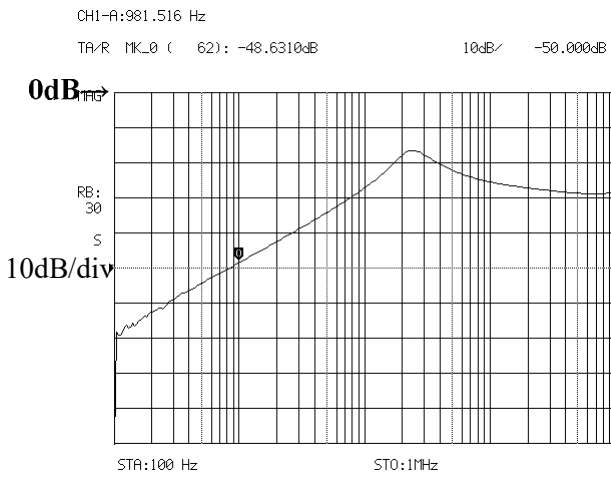

■ $C_{out} = 1.0\mu F$ (Tantalum), $I_{out} = 100mA$

■ $C_{out} = 1.0\mu F$ (MLCC), $I_{out} = 100mA$

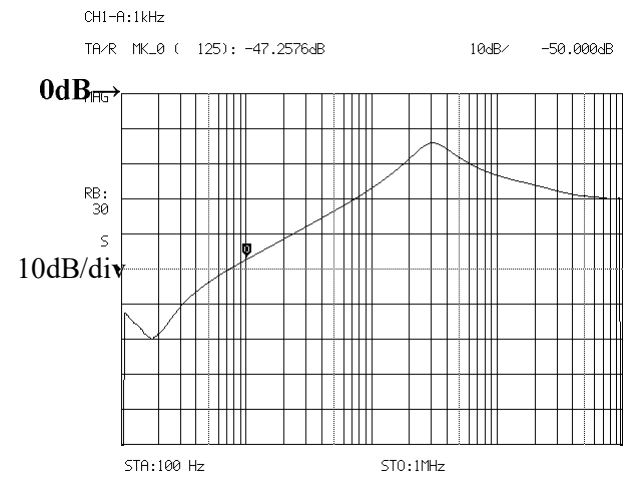
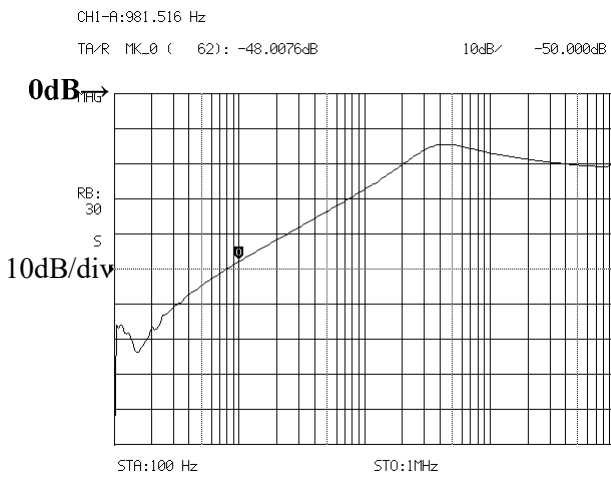

■Cout=2.2uF(Tantalum),Iout=5mA

CHI-A:981.516 Hz 03/11/07 14:12
 TA/R MK_0 (62): -48.0515dB 10c

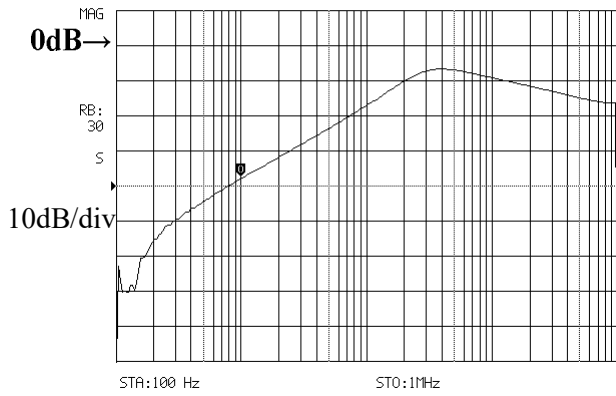

■Cout=2.2uF(MLCC),Iout=5mA

CHI-A:1kHz 03/11/18 13:38
 TA/R MK_0 (125): -47.5159dB 10c

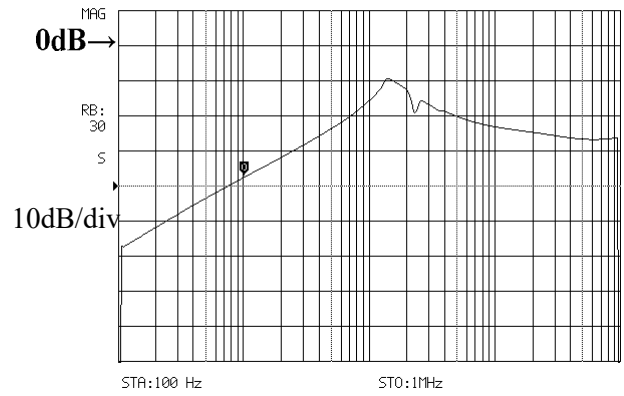

■Cout=2.2.uF(Tantalum),Iout=100mA

CHI-A:981.516 Hz 03/11/07 14:12
 TA/R MK_0 (62): -47.8021dB 10c

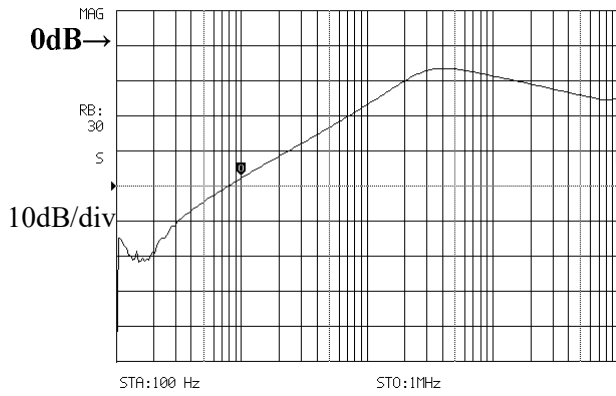

■Cout=2.2uF(MLCC),Iout=100mA

CHI-A:1kHz 03/11/18 13:42
 TA/R MK_0 (125): -46.9824dB 10c

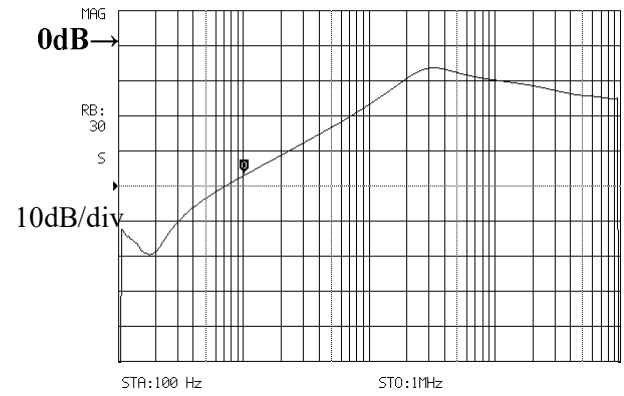

11.7 ESR Stability

IC does operate with 1.0uF Cout. If it is 1.0uF or larger, the capacitor of any type can be used in all range without considering ESR. But due to the parts are uneven, please enlarge the capacitance as much as possible. With larger capacity, the output noise decreases more. In addition, the response to the load change, etc. can be improved. The IC won't be damaged by enlarging the capacity.

The input capacitor is necessary in case the battery voltage drops, the power supply impedance increases, or the distance to the power supply is far. 1 input capacitor might be necessary for each 1 IC or for several ICs. It depends on circuit condition. Please confirm the stability by each circuit.

Generally, Multi-layer ceramic capacitor (MLCC) has the temperature characteristic and the voltage characteristic. Please select parts in consideration of the voltage and the temperature used.

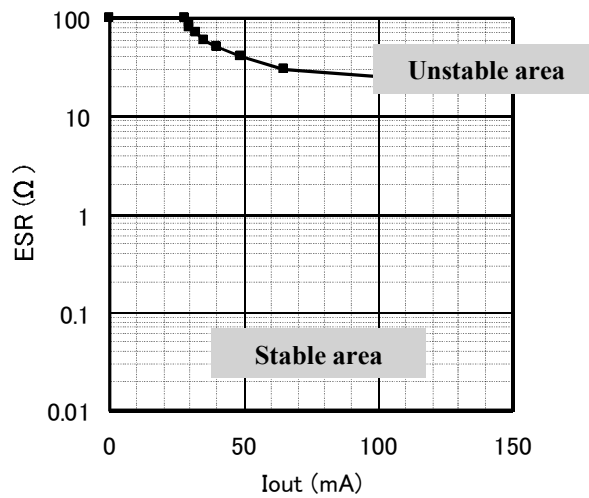

Figure 2. Stability area graph
 Condition: Vin=Vout(typ)-1.5V Cin=0.1μF, Cout=1.0μF (MLCC)

The output can be seen as oscillated when the overheating protection or the overcurrent protection start operation, or the input voltage is low. In this case, please lower the power consumption, decrease the load current or make the input voltage higher.

Generally, a ceramic capacitor has the temperature characteristic and the voltage characteristic. Please select parts in consideration of the voltage and the temperature used. ASAHI KASEI TOKO POWER DEVICES recommend B characteristic type.

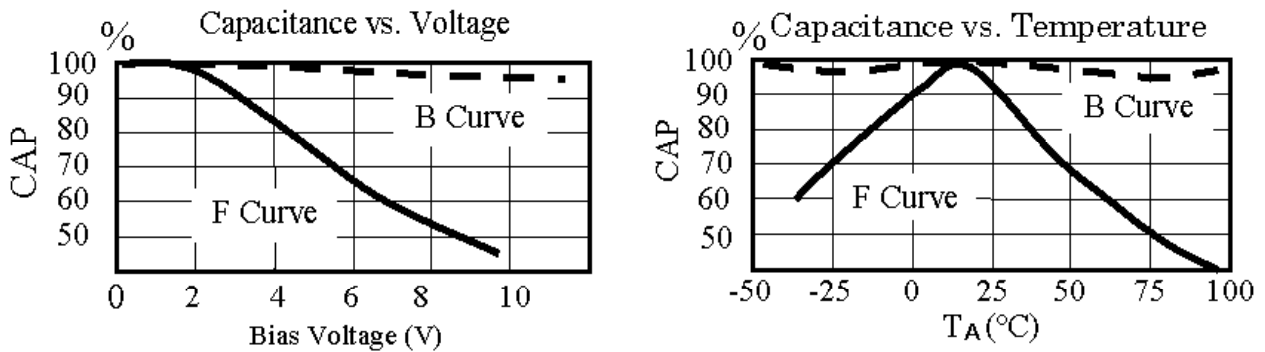

Figure 3. (Left) Capacitance vs. Voltage; (Right) Capacitance vs. Temperature

11.8 Operating Region and Power Dissipation

The power dissipation of the device is dependent on the junction temperature. Therefore, the package dissipation is assumed to be an internal limitation. The package itself does not have enough heat radiation characteristic due to the small size. Heat runs away by mounting IC on PCB. This value changes by the material, copper pattern etc. of PCB.

The overheating protection operates when there is a lot of loss inside the regulator (Ambient temperature high, heat radiation bad, etc.). The output current and the output voltage will drop when the protection circuit operates. When joint temperature (Tj) reaches the set temperature, IC stops the operation. However, operation begins at once when joint temperature (Tj) decreases.

• **The thermal resistance when mounted on PCB**

The chip joint temperature during operation is shown by $T_j = \theta_{ja} \times P_d + T_a$. Joint part temperature (Tj) of AP1156ADSxx is limited around 150°C with the overheating protection circuit. Pd is the value when the overheating protection circuit starts operation. When you assume the ambient temperature to be 25°C,

$$150 = \theta_{ja} \times P_d (W) + 25$$

$$\theta_{ja} \times P_d = 125$$

$$\theta_{ja} = 125 / P_d \text{ (}^\circ\text{C/W)}$$

▪ **Example of mounting substrate**

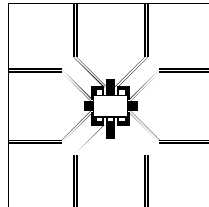

Figure 4. PCB Material: Two layer glass epoxy substrate (x=30mm,y=30mm,t=1.0mm,Copper pattern thickness 35um)

Please do derating with 5.9mW/°C at Pd=736mW and 25°C or higher. Thermal resistance is ($\theta_{ja}=170^\circ\text{C/W}$)

• **Method of obtaining Pd easily**

Connect output terminal to GND(short circuited), and measure the input current by increasing the input voltage gradually up to 10V. The input current will reach the maximum output current, but will decrease soon according to the chip temperature rising, and will finally enter the state of thermal equilibrium (natural air cooling) The input current and the input voltage of this state will be used to calculate the Pd.

$$P_d (mW) \cong V_{in} (V) \times I_{in} (mA)$$

When the device is mounted, mostly achieve 600mW or more.

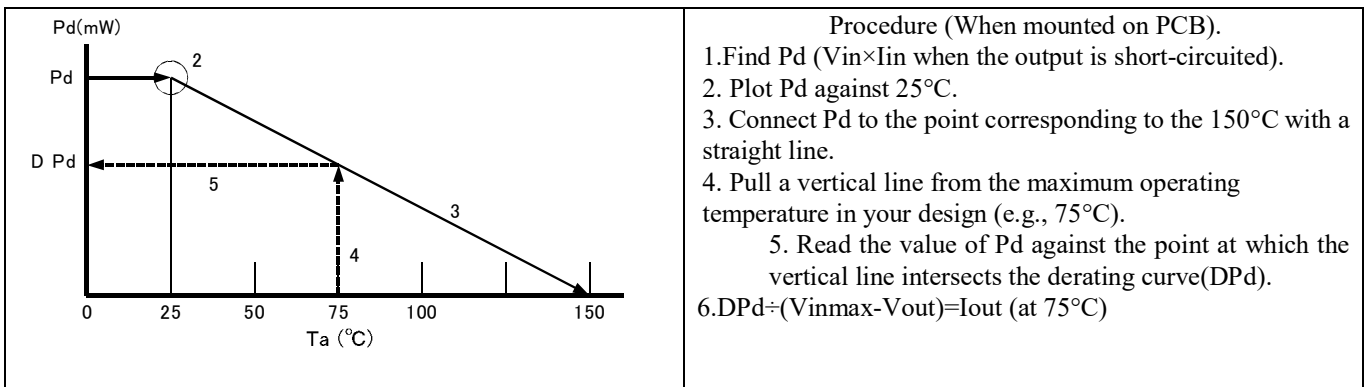

Figure 5. Method of obtaining Pd

The maximum output current at the highest operating temperature will be $I_{out} = DPd \div (V_{inmax} - V_{out})$. Please use the device at low temperature with better radiation. The lower temperature provides better quality.

• The operation area

P_d when mounted on the substrate as shown on the Figure 4. ($T_a=25^\circ C$)

SOT23-5=736mW (derating -5.9mW)

The current which can be used continuously with $T_a=25^\circ C$ min is calculated by the following.

$$I_{out}(mA) = \frac{736 - 5.9 \times (T_a - 25)}{|V_{in}| - |V_{out}|} \dots \text{SOT23-5}$$

* $I_{out} < 150mA$

The operation area is the part enclosed in the line including the “0” mentioned in graph1

The overheating sensor may operate, or the output voltage may drop outside those area.

The heat radiation characteristic changes in various conditions, so please check under your condition.

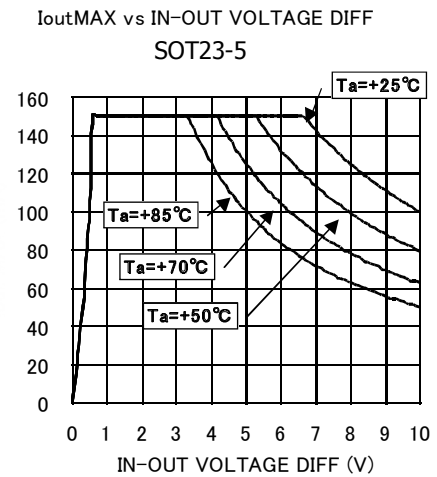
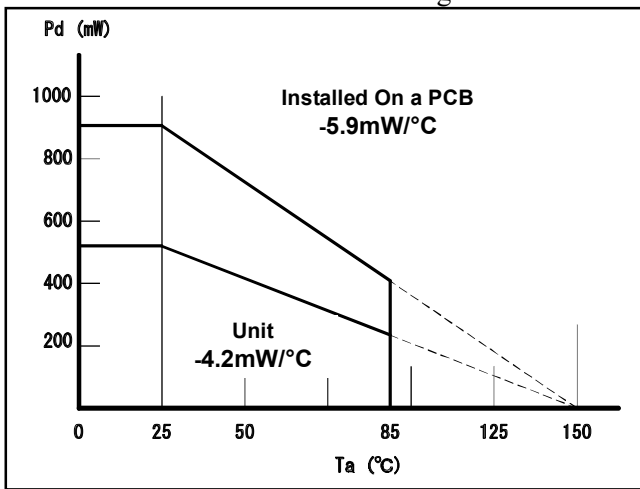

Figure 6. SOT23-5

11.9 Application hint

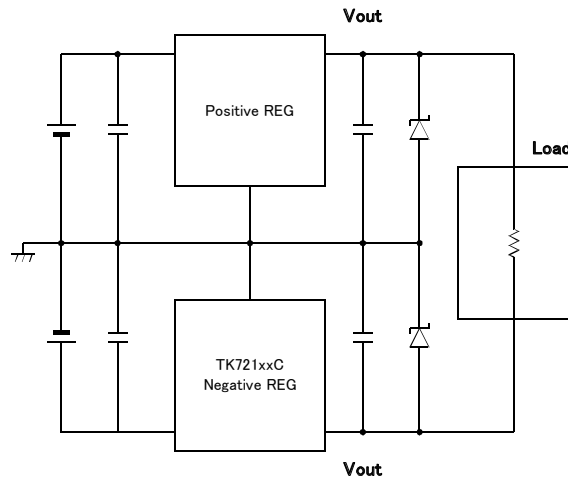

Figure 7.

When using positive output regulator together with this device, sometimes the voltage may not be outputted. To solve this problem, please connect Schottky diode between GND and output, or change the timing of On/Off.

12. Definition of term

■ Relating Characteristic

Each characteristic will be measured in a short period not to be influenced by joint temperature (T_j).

- **Output voltage (V_{out})**

The output voltage is specified with $V_{in} = V_{out}(typ) + 1V$ and $I_{out} = 5mA$

- **Output current (I_{out})**

Output current, which can be used continuously (It is the range where overheating protection of the IC does not operate.)

- **Peak output current ($I_{outPEAK}$)**

The rated output current is specified under the condition where the output voltage drops 90% by increasing the output current, compared to the value specified at $V_{in} = V_{out}(typ) - 1.5V$.

- **Dropout voltage (V_{drop})**

It is an I/O voltage difference when the circuit stops the stable operation by decreasing the input voltage.

It is measured when the output voltage drops 100mV from its nominal value by decreasing the input voltage gradually.

- **Line Regulation ($LinReg$)**

It is the fluctuations of the output voltage value when the input voltage is changed.

- **Load Regulation ($LoaReg$)**

It is the fluctuations of output voltage value when the input voltage is assumed to be $V_{out}(typ) - 1.5V$, and the load current is changed.

- **Ripple Rejection ($R.R$)**

Ripple rejection is the ability of the regulator to attenuate the ripple content of the input voltage at the output.

It is measured with the condition of $V_{in} = V_{out} - 2.0V$. Ripple rejection is the ratio of the ripple content between the output vs. input and is expressed in dB

- **Standby current ($I_{standby}$)**

It is an input current which flows to the Cont terminal, when the IC is turned off.

■ Relating Protection Circuit

- **Over Current Protection**

It is a function to protect the IC by limiting the output current when excessive current flows to IC, such as the output is connected to GND, etc.

- **Thermal Protection**

It protects the IC not to exceed the permissible power consumption of the package in case of large power loss inside the regulator.

The output is turned off when the chip reaches around $150^{\circ}C$, but it turns on again when the temperature of the chip decreases.

13. Test Circuit

■ Test Circuit

DC

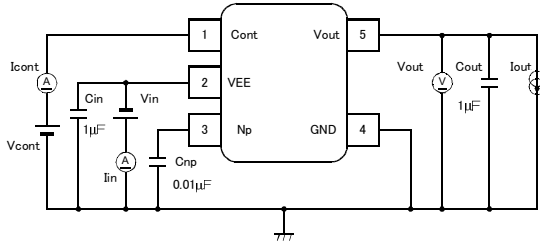

Load Transient

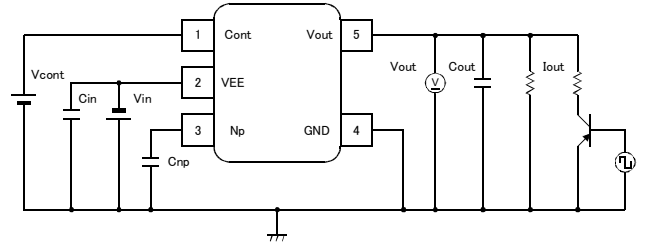

Line Transient

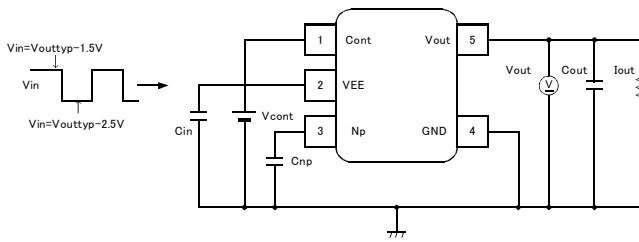

ON/OFF Transient

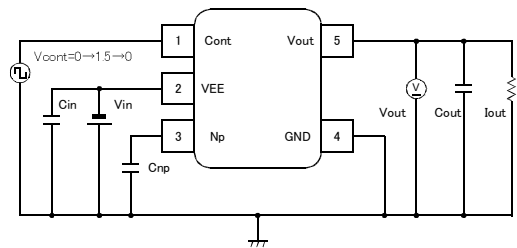

Ripple Rejection

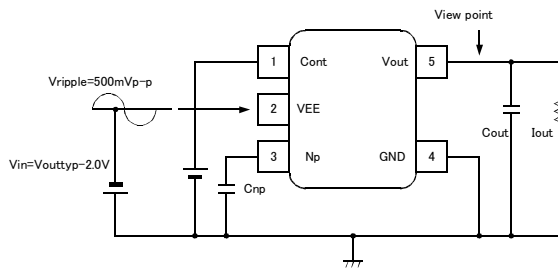

ESR Stability

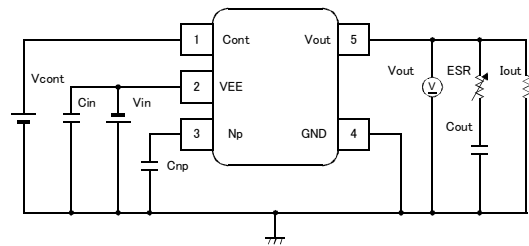

External Components

MLCC: Multi layer Ceramic Capacitor

Tantalum: Tantalum Capacitor

Figure 8. Test Circuit

14. Package

■ Outline Dimensions

(Unit:mm)

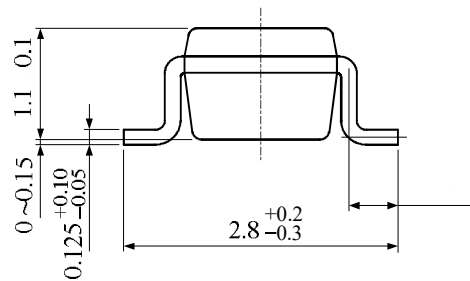
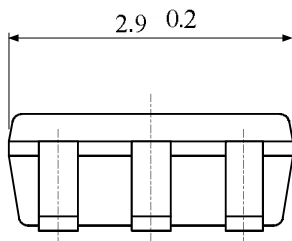
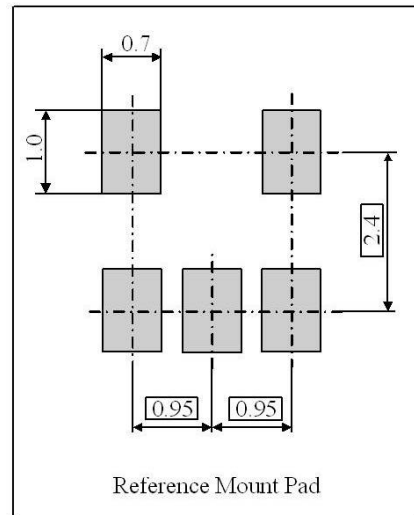
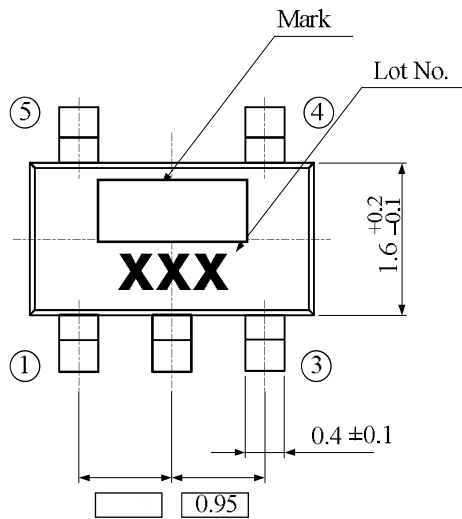

15. Revise History

Date (YY/MM/DD)	Revision	Page	Contents
14/10/29	00	-	First Edition

IMPORTANT NOTICE

0. Asahi Kasei Microdevices Corporation (“AKM”) reserves the right to make changes to the information contained in this document without notice. When you consider any use or application of AKM product stipulated in this document (“Product”), please make inquiries the sales office of AKM or authorized distributors as to current status of the Products.
1. All information included in this document are provided only to illustrate the operation and application examples of AKM Products. AKM neither makes warranties or representations with respect to the accuracy or completeness of the information contained in this document nor grants any license to any intellectual property rights or any other rights of AKM or any third party with respect to the information in this document. You are fully responsible for use of such information contained in this document in your product design or applications. AKM ASSUMES NO LIABILITY FOR ANY LOSSES INCURRED BY YOU OR THIRD PARTIES ARISING FROM THE USE OF SUCH INFORMATION IN YOUR PRODUCT DESIGN OR APPLICATIONS.
2. The Product is neither intended nor warranted for use in equipment or systems that require extraordinarily high levels of quality and/or reliability and/or a malfunction or failure of which may cause loss of human life, bodily injury, serious property damage or serious public impact, including but not limited to, equipment used in nuclear facilities, equipment used in the aerospace industry, medical equipment, equipment used for automobiles, trains, ships and other transportation, traffic signaling equipment, equipment used to control combustions or explosions, safety devices, elevators and escalators, devices related to electric power, and equipment used in finance-related fields. Do not use Product for the above use unless specifically agreed by AKM in writing.
3. Though AKM works continually to improve the Product’s quality and reliability, you are responsible for complying with safety standards and for providing adequate designs and safeguards for your hardware, software and systems which minimize risk and avoid situations in which a malfunction or failure of the Product could cause loss of human life, bodily injury or damage to property, including data loss or corruption.
4. Do not use or otherwise make available the Product or related technology or any information contained in this document for any military purposes, including without limitation, for the design, development, use, stockpiling or manufacturing of nuclear, chemical, or biological weapons or missile technology products (mass destruction weapons). When exporting the Products or related technology or any information contained in this document, you should comply with the applicable export control laws and regulations and follow the procedures required by such laws and regulations. The Products and related technology may not be used for or incorporated into any products or systems whose manufacture, use, or sale is prohibited under any applicable domestic or foreign laws or regulations.
5. Please contact AKM sales representative for details as to environmental matters such as the RoHS compatibility of the Product. Please use the Product in compliance with all applicable laws and regulations that regulate the inclusion or use of controlled substances, including without limitation, the EU RoHS Directive. AKM assumes no liability for damages or losses occurring as a result of noncompliance with applicable laws and regulations.
6. Resale of the Product with provisions different from the statement and/or technical features set forth in this document shall immediately void any warranty granted by AKM for the Product and shall not create or extend in any manner whatsoever, any liability of AKM.
7. This document may not be reproduced or duplicated, in any form, in whole or in part, without prior written consent of AKM.