



### Main

|                               |                          |
|-------------------------------|--------------------------|
| Range of Product              | Harmony XB5              |
| Product or Component Type     | Head for selector switch |
| Device short name             | ZB5                      |
| Bezel material                | Dark grey plastic        |
| Mounting diameter             | 0.87 in (22 mm)          |
| Head type                     | Standard                 |
| Sale per indivisible quantity | 1                        |
| Shape of signaling unit head  | Round                    |
| Type of operator              | Stay put                 |
| Operator profile              | Black knurled knob       |
| Operator position information | 2 positions 90°          |

### Complementary

|                             |  |
|-----------------------------|--|
| CAD overall width           | 1.14 in (29 mm)  |
| CAD overall height          | 1.14 in (29 mm)  |
| CAD overall depth           | 1.81 in (46 mm)  |
| Net Weight                  | 0.04 lb(US) (0.02 kg)  |
| Mechanical durability       | 1000000 cycles   |
| Station name                | XALD 1...5 cut-outs<br>XALK 2...5 cut-outs   |
| Electrical composition code | C4 6 single and double front mounting<br>C5 5 single front mounting<br>C6 5 single and double front mounting<br>C7 4 single front mounting<br>C8 4 single and double front mounting<br>C11 3 single front mounting<br>C3 6 single front mounting<br>C15 1 single front mounting<br>SF1 3 single front mounting<br>SR1 3 single rear mounting |
| Device presentation         | Basic element  |

### Environment

|                                       |   |
|---------------------------------------|---|
| Protective treatment                  | TH  |
| Ambient Air Temperature for Storage   | -40...158 °F (-40...70 °C)                    |
| Ambient air temperature for operation | -40...158 °F (-40...70 °C)                    |
| Overvoltage category                  | Class II IEC 60536                            |
| IP degree of protection               | IP67 IEC 60529<br>IP69<br>IP69K               |
| NEMA degree of protection             | NEMA 13<br>NEMA 4X                            |
| Resistance to high pressure washer    | 1015.26 psi (7000000 Pa) 131 °F (55 °C) 0.1 m |
| IK degree of protection               | IK06 IEC 50102                                |

|                        |   |
|------------------------|---|
| Standards              | CSA C22.2 No 14<br>EN/IEC 60947-5-4<br>JIS C8201-5-1<br>EN/IEC 60947-5-1<br>UL 508<br>EN/IEC 60947-1<br>JIS C8201-1 |
| Product Certifications | UL Listed<br>GL<br>CSA<br>BV<br>DNV<br>LROS (Lloyds register of shipping)   |
| Vibration resistance   | 5 gn 2...500 Hz)IEC 60068-2-6   |
| Shock resistance       | 30 gn 18 ms) half sine wave acceleration IEC 60068-2-27<br>50 gn 11 ms) half sine wave acceleration IEC 60068-2-27  |





## Ordering and shipping details

|                       |                                       |
|-----------------------|---------------------------------------|
| Category              | 22467 - PUSHBUTTONS,22MM(PLASTIC) NEW |
| Discount Schedule     | CS2                                   |
| GTIN                  | 3389110905052                         |
| Nbr. of units in pkg. | 1                                     |
| Package weight(Lbs)   | 0.99 oz (28 g)                        |
| Returnability         | No                                    |
| Country of origin     | FR                                    |

## Packing Units

|                              |                        |
|------------------------------|------------------------|
| Unit Type of Package 1       | PCE                    |
| Package 1 Height             | 1.77 in (4.5 cm)       |
| Package 1 width              | 1.34 in (3.4 cm)       |
| Package 1 Length             | 2.13 in (5.4 cm)       |
| Unit Type of Package 2       | BB1                    |
| Number of Units in Package 2 | 5                      |
| Package 2 Weight             | 4.97 oz (141 g)        |
| Package 2 Height             | 1.77 in (4.5 cm)       |
| Package 2 width              | 1.34 in (3.4 cm)       |
| Package 2 Length             | 10.43 in (26.5 cm)     |
| Unit Type of Package 3       | S02                    |
| Number of Units in Package 3 | 100                    |
| Package 3 Weight             | 6.82 lb(US) (3.093 kg) |
| Package 3 Height             | 5.91 in (15 cm)        |
| Package 3 width              | 11.81 in (30 cm)       |
| Package 3 Length             | 15.75 in (40 cm)       |

## Offer Sustainability

|                            |   |
|----------------------------|---|
| Sustainable offer status   | Green Premium product   |
| California proposition 65  | WARNING: This product can expose you to chemicals including: Di-isodecyl phthalate (DIDP), which is known to the State of California to cause birth defects or other reproductive harm. For more information go to <a href="http://www.P65Warnings.ca.gov">www.P65Warnings.ca.gov</a> |
| REACH Regulation           |  <a href="#">REACH Declaration</a>   |
| REACH free of SVHC         | Yes   |
| EU RoHS Directive          | Pro-active compliance (Product out of EU RoHS legal scope)  <a href="#">EU RoHS Declaration</a>  |
| Toxic heavy metal free     | Yes   |
| Mercury free               | Yes   |
| RoHS exemption information |  <a href="#">Yes</a>   |
| China RoHS Regulation      |  <a href="#">China RoHS Declaration</a>  |

---

|                          |   |
|--------------------------|---|
| Environmental Disclosure | <a href="#">Product Environmental Profile</a> |
| Circularity Profile      | <a href="#">End Of Life Information</a>       |

---

### Contractual warranty

---

|          |           |
|----------|-----------|
| Warranty | 18 months |
|----------|-----------|

---

---

Dimensions

---

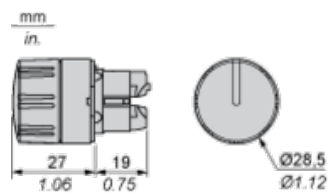

Panel Cut-out for Pushbuttons, Switches and Pilot Lights (Finished Holes, Ready for Installation)

Connection by Screw Clamp Terminals or Plug-in Connectors or on Printed Circuit Board



- (1) Diameter on finished panel or support
- (2) For selector switches and Emergency stop buttons, use of an anti-rotation plate type ZB5AZ902 is recommended.
- (3)  $\varnothing 22.5$  mm recommended ( $\varnothing 22.3 \text{ }_0^{+0.4}$ ) /  $\varnothing 0.89$  in. recommended ( $\varnothing 0.88 \text{ in. }_0^{+0.016}$ )

| Connections                                   | a in mm | a in in. | b in mm | b in in. |
|---|---------|----------|---------|----------|
| By screw clamp terminals or plug-in connector | 40      | 1.57     | 30      | 1.18     |
| By Faston connectors                          | 45      | 1.77     | 32      | 1.26     |
| On printed circuit board                      | 30      | 1.18     | 30      | 1.18     |

Detail of Lug Recess



- (1) Diameter on finished panel or support
- (2) For selector switches and Emergency stop buttons, use of an anti-rotation plate type ZB5AZ902 is recommended.
- (3)  $\varnothing 22.5$  mm recommended ( $\varnothing 22.3 \text{ }_0^{+0.4}$ ) /  $\varnothing 0.89$  in. recommended ( $\varnothing 0.88 \text{ in. }_0^{+0.016}$ )

Pushbuttons, Switches and Pilot Lights for Printed Circuit Board Connection

Panel Cut-outs (Viewed from Installer's Side)

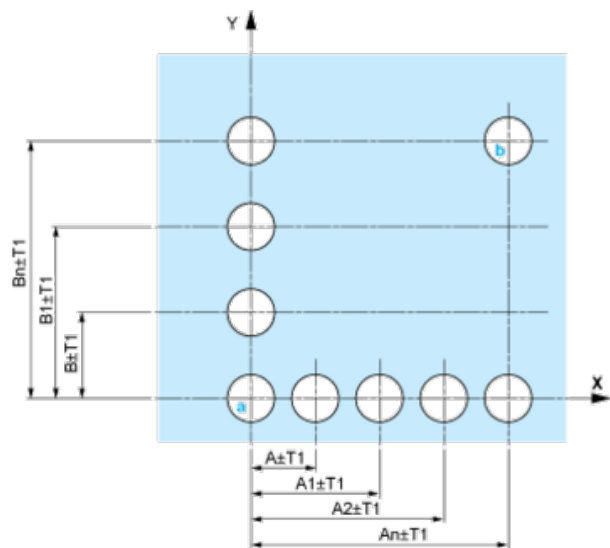

A: 30 mm min. / 1.18 in. min.  
 B: 40 mm min. / 1.57 in. min.

Printed Circuit Board Cut-outs (Viewed from Electrical Block Side)

Dimensions in mm

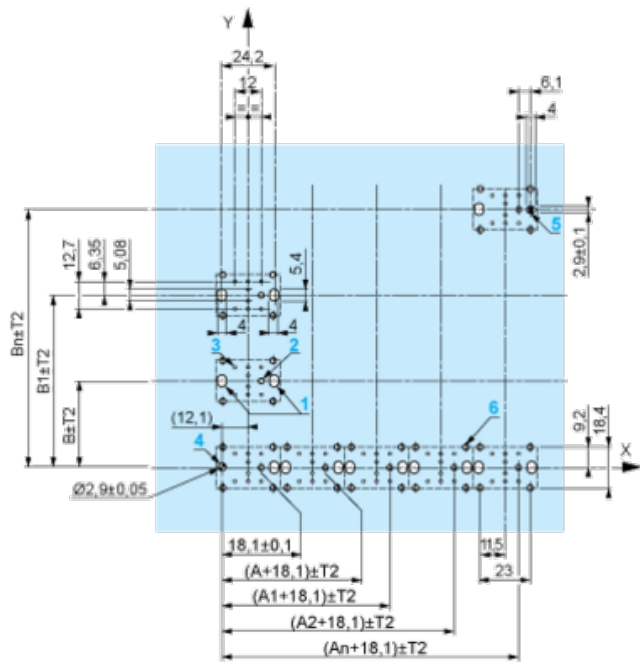

A: 30 mm min.  
 B: 40 mm min.  
 Dimensions in in.



A: 1.18 in. min.

B: 1.57 in. min.

### General Tolerances of the Panel and Printed Circuit Board

The cumulative tolerance must not exceed 0.3 mm / 0.012 in.:  $T1 + T2 = 0.3 \text{ mm max.}$

### Installation Precautions

- Minimum thickness of circuit board: 1.6 mm / 0.06 in.
- Cut-out diameter: 22.4 mm  $\pm$  0.1 / 0.88 in.  $\pm$  0.004
- Orientation of body/fixing collar ZB5AZ009:  $\pm 2^\circ 30'$  (excluding cut-outs marked a and b).
- Tightening torque of screws ZBZ006: 0.6 N.m (5.3 lbf.in) max.
- Allow for one ZB5AZ079 fixing collar/pillar and its fixing screws:
  - every 90 mm / 3.54 in. horizontally (X), and 120 mm / 4.72 in. vertically (Y).
  - with each selector switch head (ZB5AD\*, ZB5AJ\*, ZB5AG\*).

The fixing centers marked a and b are diagonally opposed and must align with those marked 4 and 5.



(1) Head ZB5AD\*

(2) Panel

(3) Nut

(4) Printed circuit board

## Mounting of Adapter (Socket) ZBZ01•

- 1 2 elongated holes for ZBZ006 screw access
- 2 1 hole  $\varnothing$  2.4 mm  $\pm$  0.05 / 0.09 in.  $\pm$  0.002 for centring adapter ZBZ01•
- 3 8  $\times$   $\varnothing$  1.2 mm / 0.05 in. holes
- 4 1 hole  $\varnothing$  2.9 mm  $\pm$  0.05 / 0.11 in.  $\pm$  0.002, for aligning the printed circuit board (with cut-out marked a)
- 5 1 elongated hole for aligning the printed circuit board (with cut-out marked b)
- 6 4 holes  $\varnothing$  2.4 mm / 0.09 in. for clipping in adapter ZBZ01•

Dimensions An + 18.1 relate to the  $\varnothing$  2.4 mm  $\pm$  0.05 / 0.09 in.  $\pm$  0.002 holes for centring adapter ZBZ01•.



---

Electrical Composition Corresponding to Code C3

---

Electrical Composition Corresponding to Code C4

---

Electrical Composition Corresponding to Code C5

---

Electrical Composition Corresponding to Code C6

---

Electrical Composition Corresponding to Code C7

---

## Electrical Composition Corresponding to Code C8

---

## Electrical Composition Corresponding to Codes C9, C11, SF1 and SR1

---

## Electrical Composition Corresponding to Code C15

---

1 N/O

1 N/C

1 N/O + N/C or 1 N/O + N/O or 1 N/C + N/C

## Legend

---

Single contact

Double contact

Light block

Possible location



## Sequence of Contacts Fitted to 2-position Selector Switch Body

### Position 315°



|          |          |        |        |        |      |
|----------|----------|--------|--------|--------|------|
| Push     | Position | Top    |        |        |      |
| Bottom   |          |        |        |        |      |
| Location |          | Left   | Centre | Right  |      |
| State    |          | 0      | 0      | 0      |      |
| Contacts | N/O      |        | open   | open   | open |
| N/C      |          | closed | closed | closed |      |

### Position 45°



|          |          |      |        |        |        |
|----------|----------|------|--------|--------|--------|
| Push     | Position | Top  |        |        |        |
| Bottom   |          |      |        |        |        |
| Location |          | Left | Centre | Right  |        |
| State    |          | 1    | 1      | 1      |        |
| Contacts | N/O      |      | closed | closed | closed |
| N/C      |          | open | open   | open   |        |