

MODEL: CUSA-TR07-008-500-TH67 | **DESCRIPTION:** ULTRASONIC SENSOR**FEATURES**

- aluminum can
- IP67 rated
- combination unit: receiver & transmitter
- high frequency

**SPECIFICATIONS**

parameter	conditions/description	min	typ	max	units
type	transmitter/receiver				
operating voltage	at 400 kHz			400	Vp-p
frequency		385	400	415	kHz
echo sensitivity	at 0.2 m	200			mV
directivity	at -6 dB	5	7	9	degree
capacitance	at 1 kHz	350	500	650	pF
detectable range		0.05		0.8	m
response time	at 200 Vp-p, 400 kHz			0.29	ms
dimensions	Ø11 x 11				mm
material	aluminum				
terminal	pins (brass with tin plating)				
weight			2.4		g
operating temperature		-40		80	°C
storage temperature		-40		85	°C
RoHS	yes				
IP level	IP67				

SOLDERABILITY

parameter	conditions/description	min	typ	max	units
wave soldering				260	°C

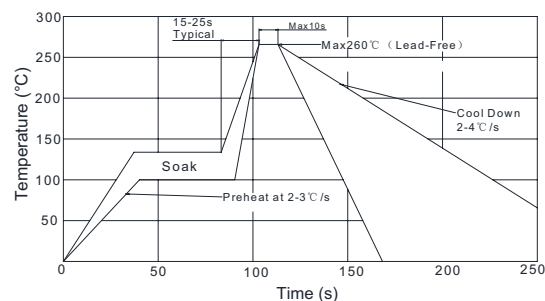

MECHANICAL DRAWING

units: mm

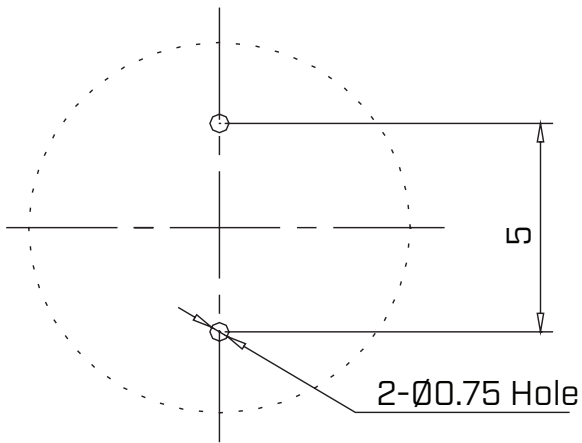
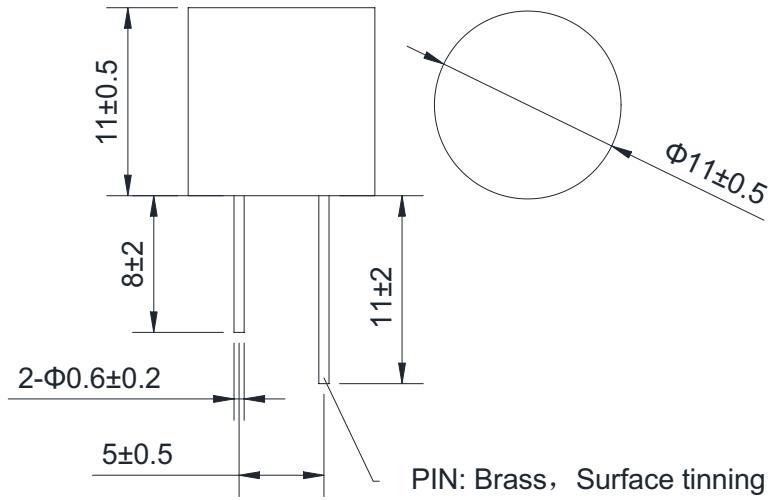

Recommended PCB Layout
Top View

BEAM PATTERNS

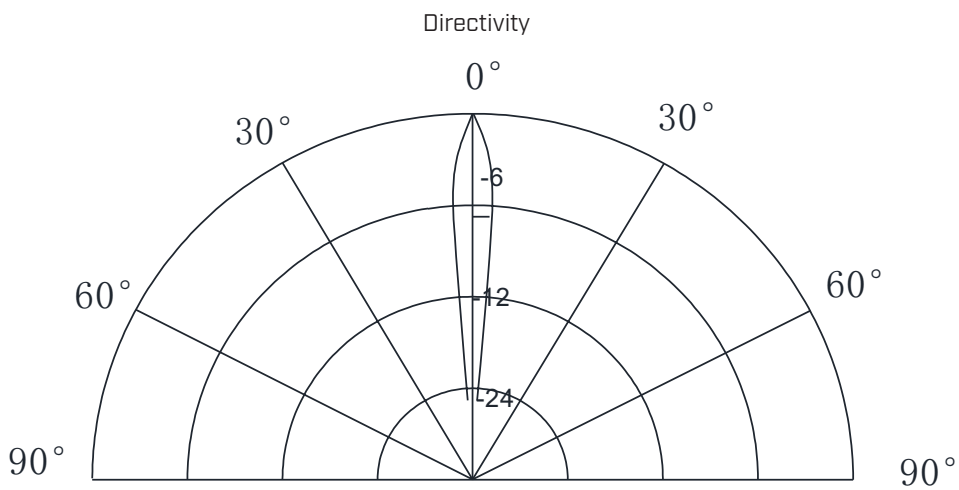

PACKAGING

units: mm

Tray Size: 235 x 135 x 30 mm
Tray QTY: 50 pcs per tray
Carton Size: 280 x 285 x 240 mm
Carton QTY: 1,000 pcs per carton

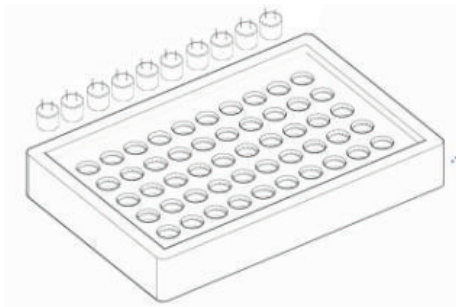

50PCS/BOX
BOX SIZE:23.5*13.5*3CM

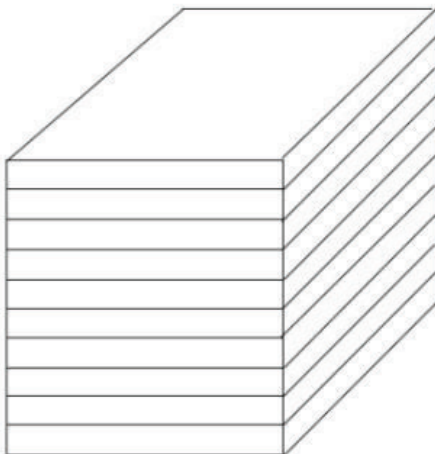

10BOXES/STACK, TOTAL 500PCS
STACK SIZE:23.5*13.5*31CM

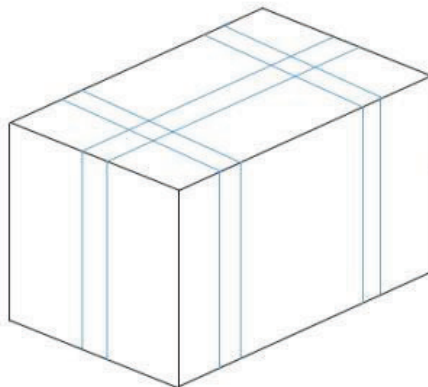

1000PCS/CARTON
CARTON SIZE:28*28.5*24CM

REVISION HISTORY

rev.	description	date
1.0	initial release	05/24/2022
1.01	logo, datasheet style update	08/05/2022

The revision history provided is for informational purposes only and is believed to be accurate.



CUI Devices offers a one (1) year limited warranty. Complete warranty information is listed on our website.

CUI Devices reserves the right to make changes to the product at any time without notice. Information provided by CUI Devices is believed to be accurate and reliable. However, no responsibility is assumed by CUI Devices for its use, nor for any infringements of patents or other rights of third parties which may result from its use.

CUI Devices products are not authorized or warranted for use as critical components in equipment that requires an extremely high level of reliability. A critical component is any component of a life support device or system whose failure to perform can be reasonably expected to cause the failure of the life support device or system, or to affect its safety or effectiveness.

cuidevices.com