

Power Cord Input EMC Filter IF 13

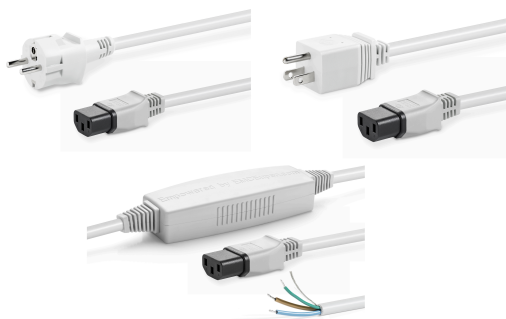

- High frequency attenuation
- Shielding and ferrite cable
- Easy to integrate in any design
- Retrofit for any IEC C14 inlet
- Rated current up to 10A
- Various powerline plugs for international usage

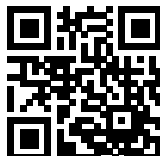

Technical Specifications

Maximum continuous operating voltage	250 VAC (120V for US plug version), 50/60 Hz
Rated currents	10 A
High potential test voltage	IF13-SE: P -> N 1200 VDC (1 min) P+N -> PE 2100 VDC (1 min) IF13-SE: P+N -> PE 2100 VAC (1 min 50Hz) P -> N 2100 VDC (1 min)
Protection category	IP 20 according IEC 60529
Temperature range (operation and storage)	-25°C to +70°C
Connector (load side)	IEC C13 according to IEC/EN 60320-2-2 stripped ends
Connector (line side) and cables	Schuko Plug CEE7/VII US NEMA5-15 plug standard stripped ends
Flammability corresponding to	Cable: UL VW-1

Approvals & Compliances



The IF13 power cord with integrated filter is the easiest way to integrate an EMC filter into a given design (with a power cord). The approach to incorporate the filter in an external cable can help to pass compliance testing at the end of the design phase. The performance of the filter is enhanced through the ferrite cable and shielding. With different versions of input and output connections the cord can be easily implemented. Complying with RoHS and REACH the power cords fulfill worldwide environmental regulations.

Features and Benefits

- Easy to implement, no redesign required
- EMC lifeline at last design stage
- High performance in high frequency range
- Retrofit for cord connected devices
- no space allocation required for filter

Typical Applications

- All cord connected applications
- Datacenter
- Communication Technology
- Medical and Laboratory devices
- Security applications
- High frequency applications
- Applications with critical housing dimensions (cable is external)

Typical Electrical Schematics

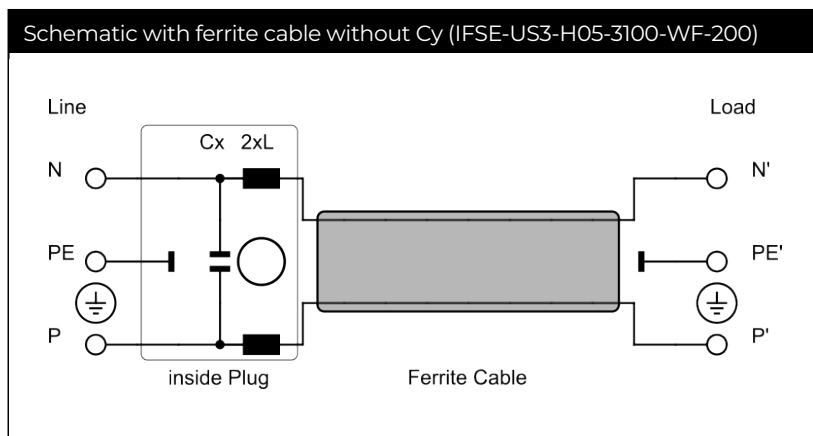
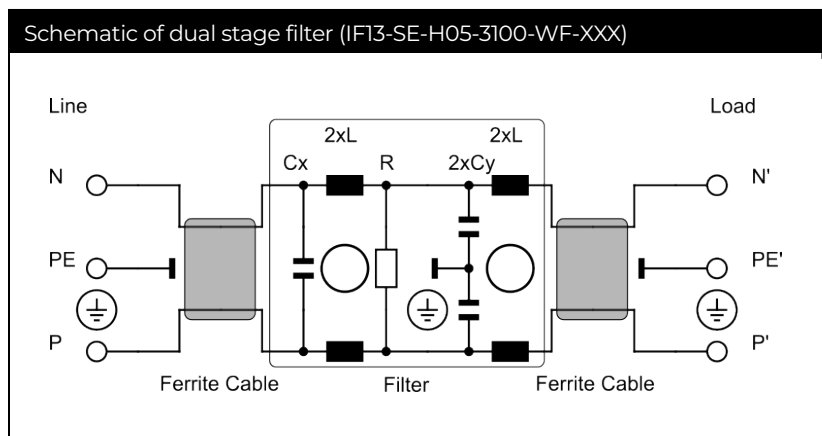
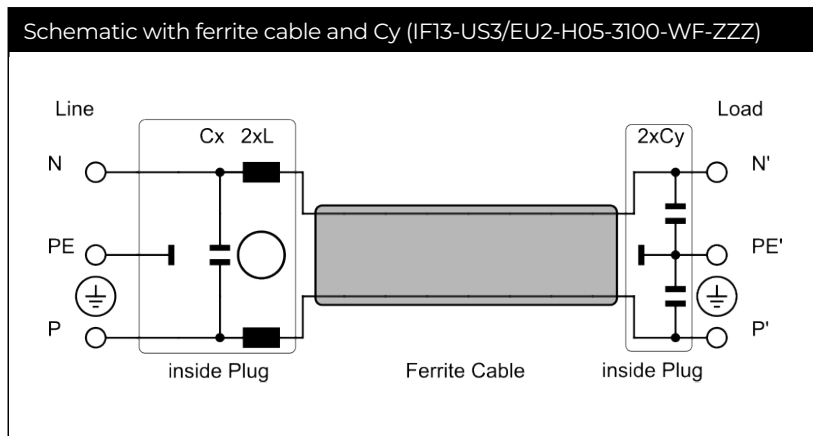
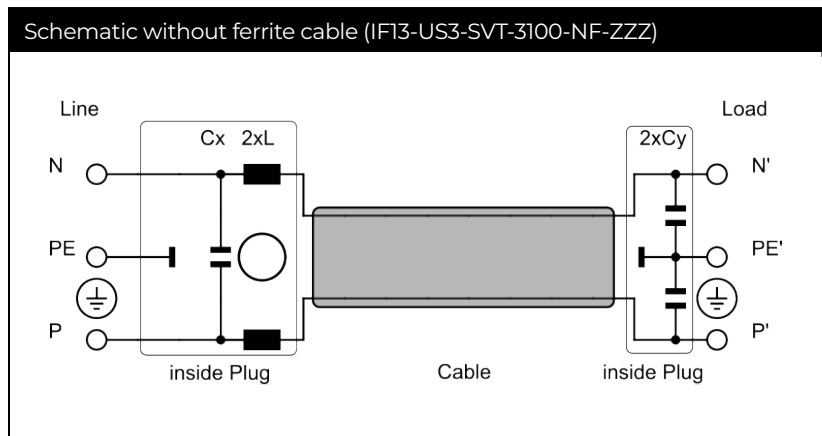

Filter Selection Table

Filter*	Rated current @ 40°C (25°C) [A]	Leakage current** @ 250V AC/50 Hz (@ 120V AC/60 Hz) [mA]	Inductance L [mH]	Capacitance		Resistance R [kΩ]	Ferrite Cable***	Input connection	Output connection	Weight (200 cm) [g]
				Cx [μF]	Cy [nF]					
IF13-US3-SVT-3100-NF-...	10	0.31 (0.18)	0.8	0.1	2.2	no	NEMA5-15	C13	240	
IF13-US3-H05-3100-WF-...	10	0.31 (0.18)	0.8	0.1	2.2	yes	NEMA5-15	C13	340	
IF13-EU2-H05-3100-WF-...	10	0.31 (0.18)	0.8	0.1	2.2	yes	CEE7/VII	C13	360	
IF13-SE-H05-3100-WF-...	10	0.31 (0.18)	0.8 (2x)	0.1	2.2	1000	yes	Stripped Ends	C13	410
IFSE-US3-H05-3100-WF-...	10	0	0.8	0.1			yes	NEMA5-15	Stripped Ends	310

* To compile a complete part number, please replace the .. with the required length.

** Maximum leakage under usual AC operating conditions (acc. IEC 60939-3). Note: if the neutral line is interrupted, worst case leakage could reach twice this level.

*** All cable is shielded

Product selector IF 13

IFxx-yyy-zzz-aaaa-bb-ccc:

- Cable length:** 200 – 200cm
- Cable version:** WF – With ferrite cable
NF – without ferrite cable
- Cable core:** 3100 – 3 X 1.00 mm² (US: AWG 18)
- Cable type:** H05 - H05VV-F
SVT - SVT
- Line side plug:** EU2 – CEE7/VII straight, integrated filter
US3 – NEMA5-15, straight, integrated filter
SE – with stripped ends
- Load side plug:** 13 - IEC C13 female plug, straight, integrated filter
SE – with stripped ends

Cable* Selection Table IF 13

IF 13-US3-SVT-3100-NF-...	IEC cable assembly with input EMC Filter, IEC C13 connector, without ferrite coated cable, US version
IF 13-US3-H05-3100-WF-...	IEC cable assembly with input EMC Filter, IEC C13 connector, with ferrite coated cable, US version
IF 13-EU2-H05-3100-WF-...	IEC cable assembly with input EMC Filter, IEC C13 connector, with ferrite coated cable, EU version
IF 13-SE-H05-3100-WF-...	IEC cable assembly with EMC Filter, IEC C13 connector, with ferrite coated cable, stripped version
IF SE-US3-H05-3100-WF-...	IEC cable assembly with input EMC Filter, stripped output, with ferrite coated cable, US version

* All cables are shielded

Typical Filter Attenuation

Per CISPR 17; A=50 Ω/50 Ω sym; B=50 Ω/50 Ω asym

IF13-US3-SVT-3100-NF-200

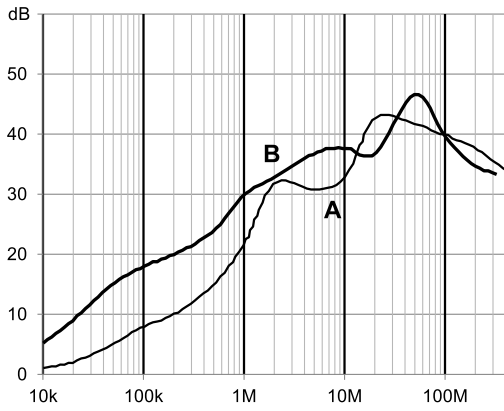

IF13-US3-H05-3100-WF-200

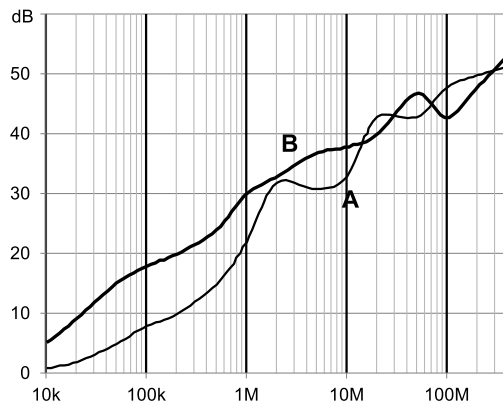

IF13-EU2-H05-3100-WF-200

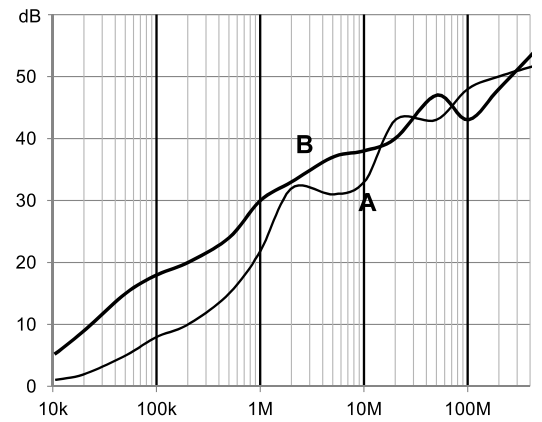

IF13-SE-H05-3100-WF-200

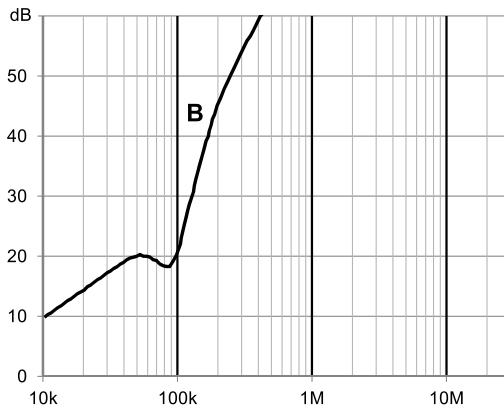

IFSE-US3-H05-3100-WF-200

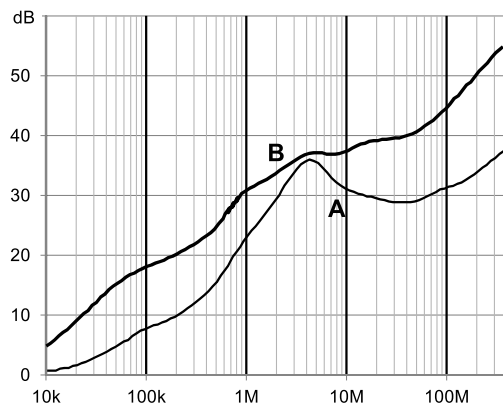

Mechanical Data

F13-US3-SVT-3100-NF

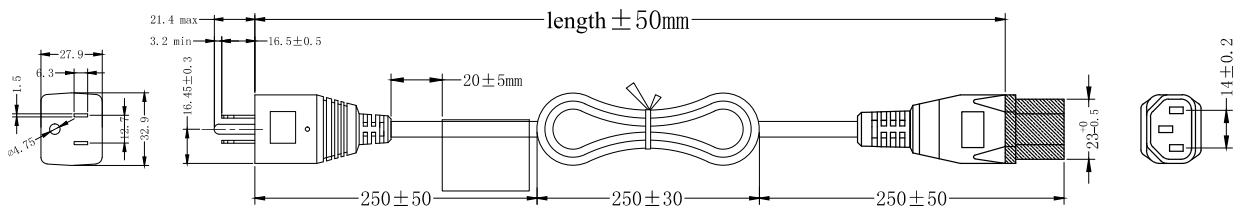

IF13-US3-H05-3100-WF

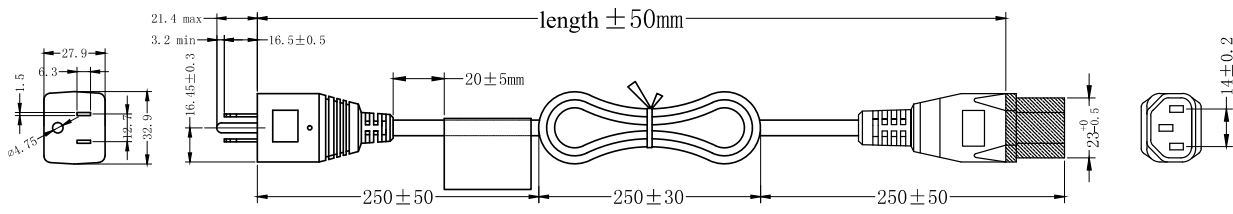

IF13-EU2-H05-3100-WF

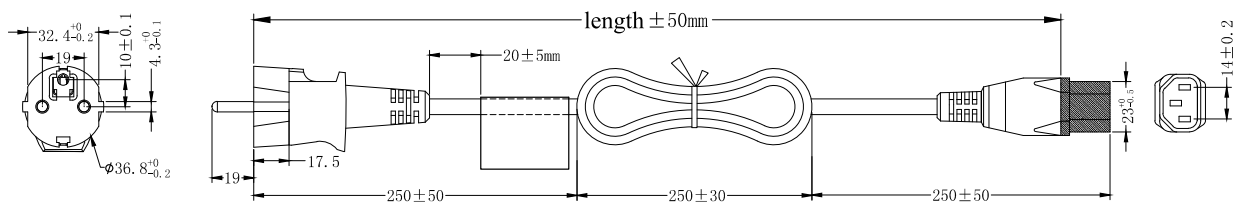

IF13-SE-H05-3100-WF-200

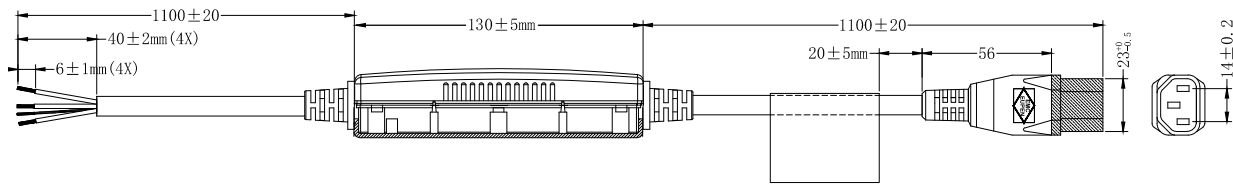

IFSE-US3-H05-3100-WF

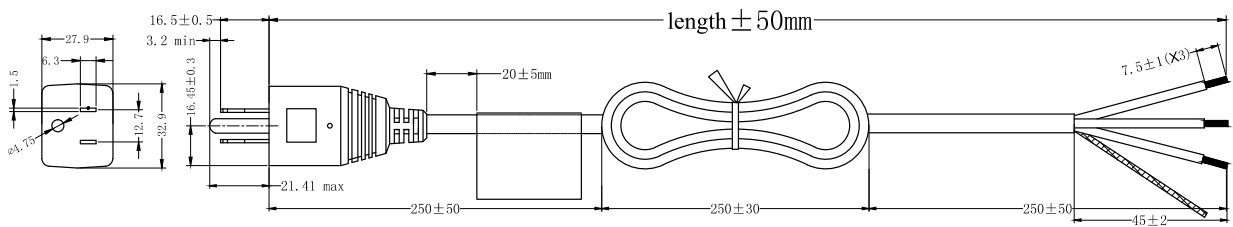

Please visit www.schaffner.com to find more details on filter connectors.

Headquarters, Global Innovation and Development

Switzerland

Schaffner Holding AG

Industrie Nord
Nordstrasse 11e
4542
Luterbach
+41 32 681 66 26
info@schaffner.com

Sales and Application Centers

Germany

Schaffner Deutschland GmbH

Schoemperlenstrasse 12B
76185
Karlsruhe
+49 721 56910
germanysales@schaffner.com

Singapore

Schaffner EMC Pte Ltd.

Blk 3015A Ubi Road 1 #05-09 Kampong Ubi
Industrial Estate
408705
Singapore
+65 63773283
singaporesales@schaffner.com

United Kingdom

Schaffner Ltd.

Suite 1 Oakmede Place
Terrace Road
RG42 4JF
Binfield
+44 118 9770070
uksales@schaffner.com

Thailand

Schaffner EMC Co. Ltd.

Sathorn Square Tower
Room 3780 37FL 98 North-Sathorn Rd Silom
Bangrak
10500
Bangkok
+66 621056397
thailandsales@schaffner.com

Taiwan

Schaffner EMV Ltd.

U-Town
20 Floor-2 No 97 Section 1 XinTai 5th Road
XiZhi District
22175
New Taipei City
+886 226975500
taiwansales@schaffner.com

France

Schaffner EMC S.A.S.

16-20 Rue Louis Rameau
95875
Bezons
+33 1 34 34 30 60
francesales@schaffner.com

Finland

Schaffner Oy

Sauvonrinne 19 H
8500
Lohja
+358 50 468 7284
finlandsales@schaffner.com

China

Schaffner EMC Ltd. Shanghai

T20-3 C No 565 Chuangye Road Pudong
district
201201
Shanghai
+86 2138139500
cschina@schaffner.com

Japan

Schaffner EMC K.K.

ISM Sangenjaya 7F
1-32-12 Kamiuma Setagaya-ku
154-0011
Tokyo
+81 3 5712 3650
japansales@schaffner.com

United States

Schaffner EMC Inc.

52 Mayfield Avenue
Edison, New Jersey
+1 732 225 9533
usasales@schaffner.com

Italy

Schaffner EMC S.r.l.

Via Ticino, 30
20900
Monza (MB)
+39 039 21 41 070
italysales@schaffner.com

India

Schaffner India Pvt. Ltd

Regus World Trade Centre
WTC 22nd Floor Unit No 2238 Brigade
Gateway Campus 26/1 Dr. Rajkumar Road
Mallechwaram (W)
560055
Bangalore
+91 8067935355
indiasales@schaffner.com

Switzerland

Schaffner EMV AG

Industrie Nord
Nordstrasse 11e
4542
Luterbach
+41 32 681 66 26
switzerlandsales@schaffner.com

Sweden

Schaffner EMC AB

Östermalmstrorg 1
114 42
Stockholm
+46 8 5050 2425
swedensales@schaffner.com

Spain

Schaffner EMC España

Calle Caléndula 93 Miniparc III Edificio E El
Soto de Moraleja Alcobendas
28109
Madrid
+34 917 912 900
spainsales@schaffner.com

To find your local partner within Schaffner's global network schaffner.com

© 2022 Schaffner Group

The content of this document has been carefully checked and understood. However, neither Schaffner nor its subsidiaries assume any liability whatsoever for any errors or inaccuracies of this document and the consequences thereof. Published specifications are subject to change without notice. Product suitability for any area of application must ultimately be determined by the customer. In all cases, products must never be operated outside their published specifications. Schaffner does not guarantee the availability of all published products. This disclaimer shall be governed by substantive Swiss law and resulting disputes shall be settled by the courts at the place of business of Schaffner Holding AG. Latest publications and a complete disclaimer can be downloaded from the Schaffner website. All trademarks recognized.