

Modular Power, Signal Connectors

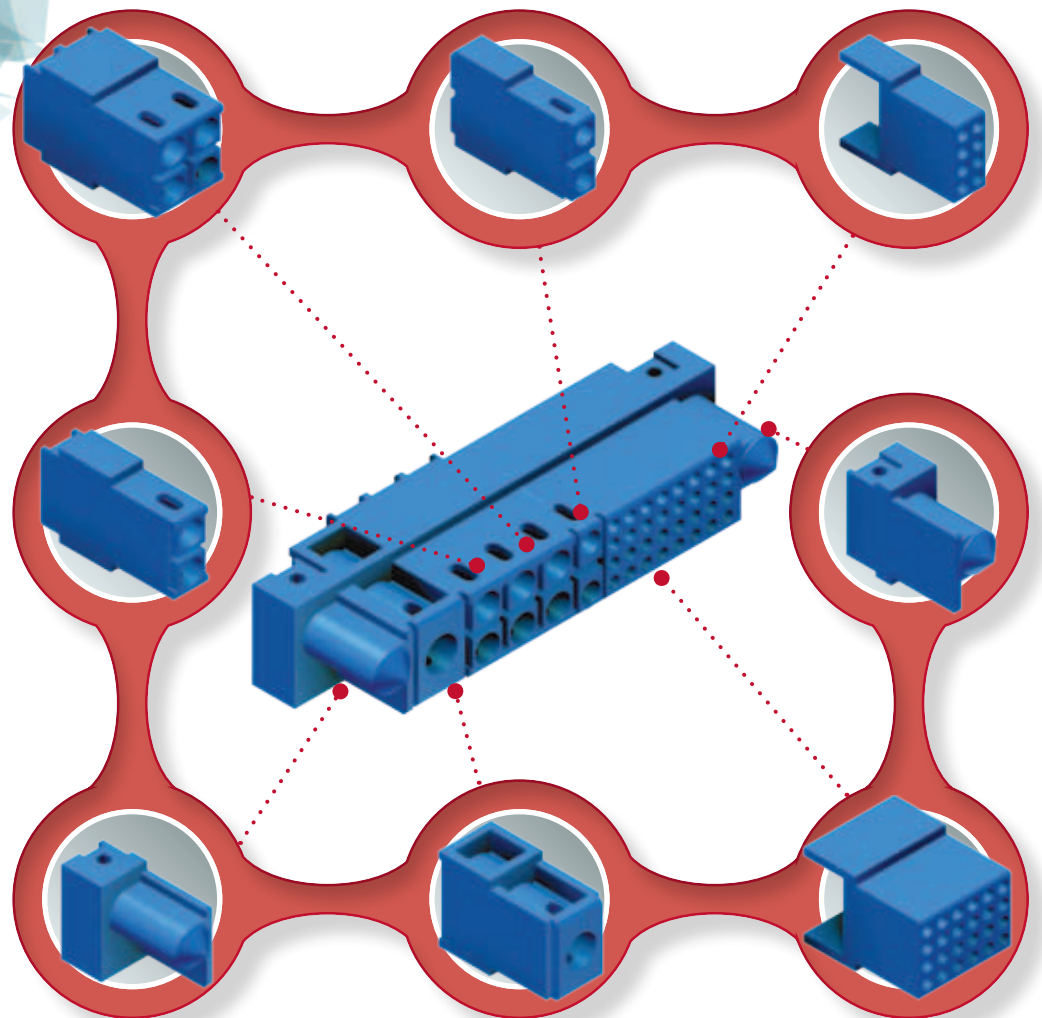

SCORPION Series





SCORPION

TABLE OF CONTENTS

- Introduction 02
- Overall Length Calculation 03
- Part Number Definition 04
- Technical Specifications 06
- Typical Connector Systems 08
- Temperature Rise Curves 10
- Guide & Locking Systems 11
- Venting Features 11
- Dimensions 12
- Insulator Dimensions 14
- Termination Dimensions 16
- Press fit Terminations 17
- Mating Dimensions 17
- Accessories 17
- Jackscrew Systems 19
- Modular Hood 20
- Strain Relief 21
- Contacts 22
- Mounting Screws 26
- Tooling 27
- Locking Clip 28
- Keying Module and Plug 28
- Crimping Procedure 29
- Sales Offices 32

INTRODUCTION - WHY SCORPION?

- ✓ Power contact options: ranging from 16 to 120 amps plus the ability to add signal contacts and a variety of accessories.
- ✓ Blind mating, float mount, panel mount and cable connector options with unique locking system.
- ✓ PC Mount, crimp, and press fit terminations.
Venting option for improved air cooling.
- ✓ Blank modules contact spacing for higher voltage needs.
- ✓ Solid machined, precision formed contacts.
- ✓ Shielded, high voltage and hyperboloid contacts options.

Information in this catalog is proprietary to Positronic and its subsidiaries. Positronic believes the data contained herein to be reliable. Since the technical information is given free of charge, the user employs such information at his own discretion and risk. Positronic assumes no responsibility for results obtained or damages incurred from use of such information in whole or in part.

The following trademarks are registered to Positronic Industries, Inc. in the United States and many other countries: Positronic Industries, Inc.[®], Positronic[®], Connector Excellence[®], P+ logo[®], PosiBand[®], PosiShop[™], Positronic Global Connector Solutions[®], Global Connector Solutions[®]. The color blue as it appears on various connectors is a trademark of Positronic Industries, Inc., Registered in U.S. Patent and Trademark Office.

DIMENSIONAL TOLERANCES

(unless otherwise specified)

- 1) ± 0.03 [0.001] for male contact mating diameters
- 2) ± 0.08 [0.003] for dimensions
- 3) ± 0.13 [0.005] for all diameters
- 4) ± 0.38 [0.015] for all other dimensions

DIMENSIONS ARE IN MILLIMETER [INCHES].
ALL DIMENSIONS ARE SUBJECT TO CHANGE.

The Positronic
FEDERAL SUPPLY CODE
(Cage Code) FOR
MANUFACTURERS IS **28198**

**POSITRONIC[®] IS AN ITAR
REGISTERED COMPANY**

Products described within this catalog may be protected by one or more of the following US patents:

*#4,900,261 #5,255,580 #5,329,697
#6,260,268 #6,835,079 #7,115,002

*Patented in Canada, 1992
Other Patents Pending

Blue colored connectors shown in this catalog are a trademark of Positronic Industries, Inc, registered in the US. Patent and Trademark Office.





Positronic is proud to participate in PICMG 3.8. The Scorpion series was chosen as the PICMG 3.8 power connector.

PICMG® logo is a registered trademark of the PCI Industrial Computers Manufacturers Group.

Using existing tooling the maximum length is 101.00mm.

Notes:

- 1 A Scorpion part number can be a maximum of 30 characters. If the connector configuration exceeds this number, please consult sales for a special part number for your unique requirement.
- 2 Pinout sequence may not be continuous. Consult sales for more information.
- 3 Consult sales for connector length exceeding 101.00 mm [3.976 inch].
- 4 Consult sales for connector offering both fixed solder and crimp contacts.
- 5 Alignment bar is only available for size 16, size18, size 22, and hyperboloid 0.60 [0.0236] right angle (90°) contacts.
- 6 PosiBand contacts available for size 12, 16, 18 and 22.

HOW TO CALCULATE THE OVERALL LENGTH (OAL) OF A SCORPION CONNECTOR

Overall Length (OAL) of a connector is the sum of all the modules length. Refer to example below for OAL calculation. See page 12 and 13 for individual module dimensions.

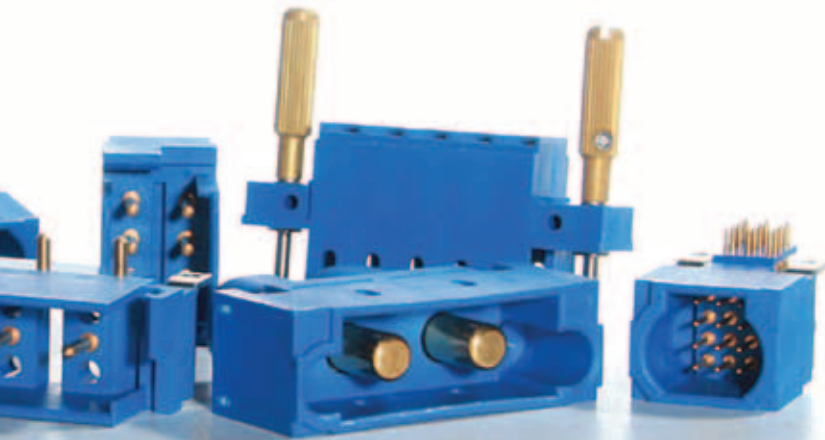
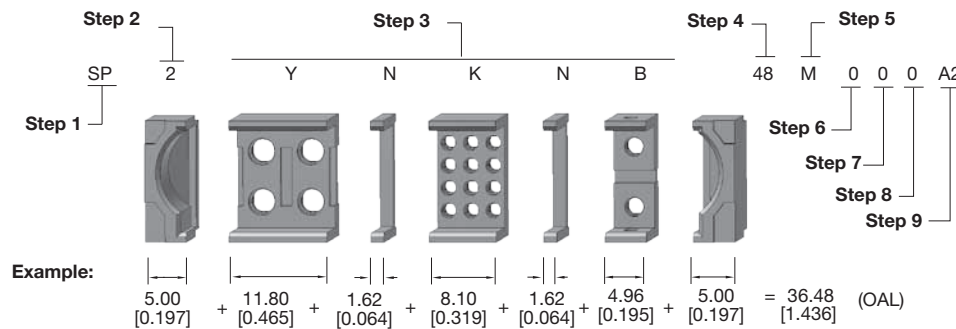

PART NUMBER DEFINITION

Specify a part number by selecting an option from each step.

STEP	1	2	3	4	
Example	SP	2	YNKNB	4	
STEP 1 - BASIC SERIES SP – Scorpion Series					
STEP 1 - GUIDE AND LOCKING OPTIONS	<ol style="list-style-type: none"> 1 - Super Blind Mating System, up to 3.80 [0.150] misalignment. 2 - Blind Mating System, up to 2.00 [0.079] misalignment. 3 - Locking Latch System, for cable to cable connectors only. 4 - Locking Latch System, for male cable to female panel/board connectors only. 5 - Locking Latch System, for female cable to male panel/board connectors only. 6 - End Module, for Use with Jackscrew System. 7 - Blind mating system, 4.50 [0.177] width, up to 2.00 [0.079] misalignment. Use with connectors with code 0, BS, or N in step 7 only. 				
STEP 3 - CONNECTOR VARIANTS - Face view of male Shown below. Consult sales for availability of other modules. It is recommended signal contacts are positioned at the center of the connector. Additional notes below.	<p>Size 4 power contact module Module U</p>		<p>Size 8 power contact modules Module R or S</p>	<p>Size 12 power contact modules Module E or Y or G</p>	
	<p>Size 16 power contact modules Module A or B or C or D</p>	<p>Size 18 power contact modules Module X or Z</p>	<p>Size 22 signal contact modules Module H or J or K or T</p>		
	<p>Size 22 precision formed signal contact modules Module L or P or Q (For Female PCB mount only.)</p>	<p>Hyperboloid 0.60mm [0.0236] Contact modules Module V or W (Unique high density contact design with machined pin diameter 0.60 [0.0236], for straight and right angle (90°) PCB mount only. Consult sales for availability of crimp terminal.)</p>	<p>Blank modules Module N or N2 or N3 or N4 or N5 Module N5 (For Hood application, place N5 next to End module)</p>	<p>Keying Module 0</p>	
STEP 4 - CONTACT TERMINATION TYPE	<ol style="list-style-type: none"> 1 - Crimp contacts, order separately. (for female connector, specify Code F in step 5). 3 - Solder, straight PCB mount. Standard conductivity power contacts. 38 - Solder, straight PCB mount. High conductivity power contacts. 4 - Solder, right angle (90°) PCB mount. Standard conductivity power contacts. 48 - Solder, right angle (90°) PCB mount. High conductivity power contacts. *93 - Press-fit compliant terminations, straight PCB mount, for use with PCB not thinner than 2.29[0.090]. *938 - Press-fit compliant terminations, straight PCB mount, for use with PCB not thinner than 2.29[0.090]. High conductivity power contacts. <p>* For contacts size 8, 12, 16 and 22 only. Contact sales for press-fit tooling part number. Sequential mating options are available. Contact sales for availability of mixed contact termination type.</p>		<p>Code 3 or 38</p>	<p>Code 4 or 48</p>	<p>Code 93 or 938</p>

Notes:

- For female connectors, the modules are placed right to left when viewed from the mating face.
- For male connectors, the modules are placed left to right.
- This means mating connector part numbers will have the same letters in the same order.

5	6	7	8	9	10	-	11
M	0	N	9	A2	/AA		

STEP 11 - SPECIAL OPTIONS, CONSULT SALES FOR SPECIAL OPTIONS.

STEP 10 - ENVIRONMENTAL COMPLIANCE OPTIONS

/AA - Compliant per EU Directive 2011/65/EU (RoHS). Example: SP2GNKNB4M0N9A1/AA

Note:

- 1 - This step will not be used if compliance to environmental legislation is not required.
Example: SP2GNKNB4M0N9A1
- 2 - Code A2, C2 and D2 of step 9 will not comply to environmental legislation.

STEP 9 - CONTACT PLATING

- 1 - Crimp contacts ordered separately.
- A1 - Gold flash over nickel on mating end termination end.
- A2 - Gold flash over nickel on mating end and 0.005[0.0002] tin-lead solder coat on termination end.
Not available with code 93, 938 in step 4.
- C1 - 0.00076[0.000030] gold over nickel on mating end and termination end.
- C2 - 0.00076[0.000030] gold over nickel on mating end and 0.005[0.0002] tin-lead solder coat on termination end.
Not available with code 93, 938 in step 4.
- D1 - 0.00127[0.000050] gold over nickel on mating end and termination end.
- D2 - 0.00127[0.000050] gold over nickel on mating end and 0.005[0.0002] tin-lead solder coat on termination end.
Not available with code 93, 938 in step 4.

Consult sales for availability of silver plating.

STEP 8 - VENT OPTIONS (For power contacts only, except module A of step 3.)

- 0 - Connector body is not vented.
- 9 - Connector body vented for air cooling.



STEP 7 - MOUNTING STYLE AND JACKSCREW SYSTEM

- 0 - None.
- B - 90° metal mounting bracket (through hole), for right angle PCB mounted connectors using code 4 or 48, see step 4.
- LN - 90° metal mounting bracket (board lock), for right angle PCB mounted connectors using code 4 or 48, see step 4.
- BS - 90° metal mounting bracket (threaded), for right angle PCB mounted connectors using code 4 or 48, see step 4.
- N - Push-on fastener for PCB mounted connectors using code 3, or 38, or 4, or 48, see step 4.
- E - Turnable male jackscrew.
- T - Fixed female jackscrew.
- TB - Fixed female jackscrew with 90° metal mounting bracket (through hole), for right angle PCB mounted connectors using code 4 or 48, see step 4.
- TLN - Fixed female jackscrew with 90° metal mounting bracket (board lock), for right angle PCB mounted connectors using code 4 or 48, see step 4.
- TN - Fixed female jackscrew with push-on fastener for PCB mounted connectors.
- W - Hood. (for use with Two N5 modules).
- WE - Hood with Rotating Jackscrew. (for use with Two N5 modules).



STEP 6 - PANEL MOUNT

- 0 - None.
- 6 - Easy release mounting clip for 1.50mm [0.059 inch] thick panel, for male panel mount connector only.
- 82 - Float mount for 1.50 mm [0.059 inch] thick panel.
- 83 - Float mount for 2.30 mm [0.091 inch] thick panel.

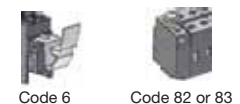

* Float mount allows 0.60 [0.0236] floating per side. Consult sales for more floating options.

STEP 5 - CONNECTOR GENDER

- M - Male
- F - Female - Standard contacts
- S - Female - Posiband contacts

TECHNICAL SPECIFICATIONS

Note:

*Hyperboloid Contacts Modules are not UL recognized as presently configured.

MATERIALS AND FINISHES

Insulators:	Glass-filled polyester, UL 94V-0. Blue color.
Contacts	Precision machined copper alloy with gold flash over nickel plate. Other finishes available upon request. Size 22 PCB straight and right angle (90°) contact also available in precision formed copper alloy with selective gold flash over nickel at mating end and tin over nickel plate at termination end.
Mounting Brackets	Brass with tin plate.
Push-on Fasteners	Copper alloy with tin plate.
Float Mount Bushings	Steel with zinc plate.
Mounting clips	Beryllium copper with nickel plate.
Jackscrew System	Passivated stainless steel.

ELECTRICAL CHARACTERISTICS

Contact Current Rating	(See Page 12 for details of Power Contacts)
Standard Conductivity Contacts	
Size 4 Contacts	100 amperes, continuous.
Size 8 Contacts	50 amperes, continuous.
Size 12 Contacts	40 amperes, continuous.
Size 16 Contacts	26 amperes, continuous.
Size 18 Contacts	16 amperes, continuous.
Size 22 Contacts	3 amperes, nominal.
*Hyperboloid Contacts 0.60mm [0.0236]	4 amperes, nominal.
High Conductivity Contacts	
Size 4 Contacts	120 amperes, continuous.
Size 8 Contacts	80 amperes, continuous.
Size 12 Contacts	60 amperes, continuous.
Size 16 Contacts	40 amperes, continuous.
Size 18 Contacts	23 amperes, continuous.
Initial Contact Resistance (Standard Conductivity Contacts) per IEC 512-2, Test 2b	
Size 4 Contacts	0.0003 ohms, maximum.
Size 8 Contacts	0.0006 ohms, maximum.
Size 12 Contacts	0.001 ohms, maximum.
Size 16 Contacts	0.0016 ohms, maximum.
Size 18 Contacts	0.003 ohms, maximum.
Size 22 Contacts	0.005 ohms, maximum.
*Hyperboloid Contacts 0.60mm [0.0236]	0.005 ohms, maximum.
Initial Contact Resistance (High Conductivity Contacts) per IEC 512-2, Test 2b	
Size 4 Contacts	0.0002 ohms, maximum.
Size 8 Contacts	0.0004 ohms, maximum.
Size 12 Contacts	0.0004 ohms, maximum.
Size 16 Contacts	0.0007 ohms, maximum.
Size 18 Contacts	0.0007 ohms, maximum.
Insulation Resistance per IEC 512-2, Test 3a, Method A	5 G ohms.
Voltage Proof per IEC 512-2, Test 4a, Method C	
For Size 4 contacts	3000 V r.m.s. typical.
For size 8, 12, 16 and 18 contacts.	2200 V r.m.s. typical.
For size 22 contacts.	1600 V r.m.s. typical.
*Hyperboloid Contacts 0.60mm [0.0236]	1200 V r.m.s. typical.
<i>Consult sales for your specific requirements.</i>	
Working Voltage, Clearance and Creepage Distances	Consult factory for information about your specific connector choice.
Hot Pluggable [50 Couplings per UL1977, paragraph 15]	
Size 12 Contacts	250 VAC at 25 amperes. <i>Contact sales for details.</i>
Size 16 Contacts	<i>Contact sales for availability.</i>

MECHANICAL CHARACTERISTICS

Super Blind Mating System	Integral guide feature allows for misalignment up to 3.80 mm [0.150 inch].
Blind Mating System	Integral guide feature allows for misalignment up to 2.00 mm [0.079 inch].
Locking Latch System	Design of connector body provides locking system for cable to cable, cable to printed board and cable to panel mount applications.
Jackscrew System	Standard threads, 4-40 UNC. <i>Consult sales for other screw sizes</i>
Polarization	Design of connector body provides polarization features.
Removable Contacts	Install contact from rear face of insulator, release from front face of insulator with a contact extraction tool, thereafter extract contact from rear face of insulator. Size 8, Size 12, Size 16, Size 18 and Size 22 female contacts feature "Closed entry" design for highest reliability.
Keying Features	8 different positions are available.
Removable Contact Retention in Connector Body per IEC 512-8, Test 15a	
Size 4 Contacts	134N [30 lbs.] minimum.
Size 8, Size 12 and Size 16 Contacts	67N [15 lbs.] minimum.
Size 18 Contacts	45N [10 lbs.] minimum.
Size 22 Contacts	27N [6 lbs.] minimum.
Non Removable Crimp Contact (Size 22 only):	Install contacts from rear face of insulator. Size 22 female contact has "closed entry" design for highest reliability.
Non Removable Crimp Contact Retention in Connector Body per IEC 512-8, Test 15a	
Size 22 Contacts	27N [6 lbs.] minimum.
Fixed Contacts	Printed board terminations, both straight and right angle. Size 8, 12, 16, 18 and Hyperboloid 0.60mm [0.0236] female contacts feature "Closed entry" design for highest reliability. Size 22 female contact has "Open Entry" design.
Fixed Contact Retention in Connector Body per IEC 512-8, Test 15a	
Size 8 Contacts	67N [15 lbs.] minimum.
Size 12 Contacts and Size 16 Contacts	45N [10 lbs.] minimum.
Size 18 Contacts	45N [10 lbs.] minimum.
Size 22 Contacts	27N [6 lbs.] minimum.
Size 22 Precision Formed Contact	27N [6 lbs.] minimum.
*Hyperboloid Contacts 0.60mm [0.0236]	27N [6 lbs.] minimum.
Sequential Contact Mating System	
Size 4 Contacts	One level.
Size 8 Contacts	Two levels.
Size 12 Contacts	Two levels. <i>Consult sales for three levels.</i>
Size 16 Contacts	Two levels. <i>Consult sales for three levels.</i>
Size 18 Contacts	Two levels. <i>Consult sales for three levels.</i>
Size 22 Contacts	One level.
*Hyperboloid Contacts 0.60mm [0.0236]	Two levels for Printed Board mount connectors. One level.
Printed Board and Panel Mounting Holes	Mounting holes provided in connector body for both printed board and panel mounting. Self-tapping screws or push-on fastener options are available.
Mechanical Operations per IEC 512-5	
Size 4, Size 8, Size 12, Size 16 and Size 18 Contacts	1000 cycles minimum.
Size 22 Contacts	500 cycles minimum.
Size 22 Precision Formed Contact	250 cycles minimum.
*Hyperboloid Contacts 0.60mm [0.0236]	Up to 100,000 cycles.
Recognized	(UL File E49351) Partial UL certification only. Consult sales for your specific connector configuration. Consult sales for TÜV.

CLIMATIC CHARACTERISTICS

Temperature Range	-55°C to +125°C
--------------------------	-----------------

2-D DRAWINGS & 3-D MODELS

Once you have made a connector selection, contact Technical Sales if you would like a 2-D drawing or 3-D model. If we do not have your specific part number on file, we can create one for you. Or, visit www.connectpositronic.com and use the search function.

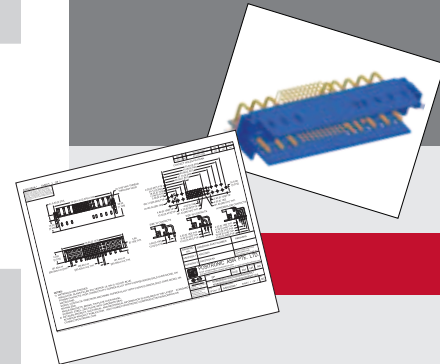

Note:
*Hyperboloid Contacts Modules are not UL recognized as presently configured.

TYPICAL CONNECTION SYSTEMS

BOARD TO PANEL
WITH BLIND MATING
SYSTEM

FEMALE CONNECTOR

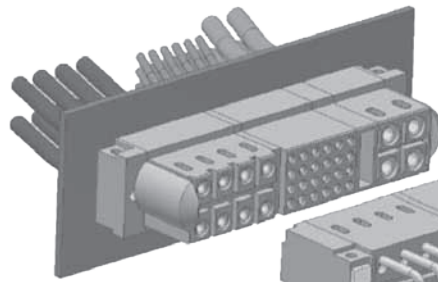

Female Panel Mount Connector
Typical part number:
SP2YN4TND1F0091
(Contacts ordered separately)

MALE CONNECTOR

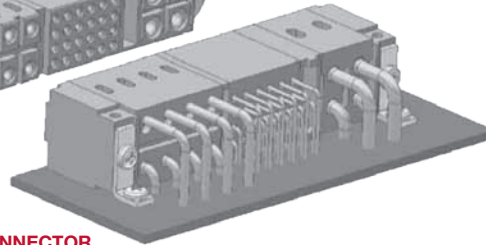

Male Right Angle (90°)
PCB Mount Connector
Typical part number:
SP2YN4TND4M0B9A1

CABLE TO BOARD
WITH
LOCKING LATCH
SYSTEM

MALE CONNECTOR

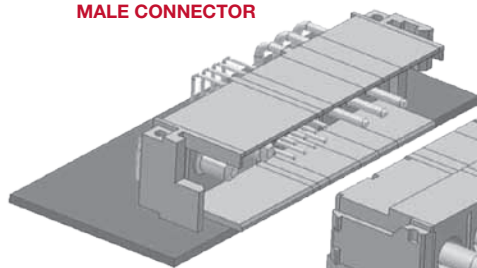

Male Right Angle (90°)
PCB Mount Connector
Typical part number:
SP5SNHKN4BC4M000A1

FEMALE CONNECTOR

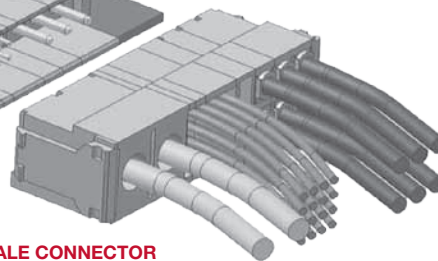

Female Cable Connector
Typical part number:
SP5SNHKN4BC1F0001
(Contacts ordered separately)

BOARD TO BOARD
WITH
BLIND MATING
SYSTEM

MALE CONNECTOR

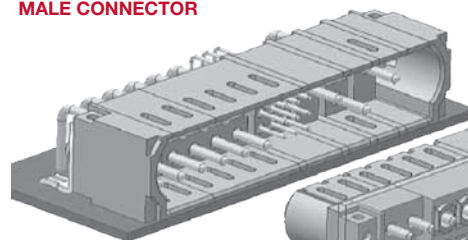

Male Right Angle (90°)
PCB Mount Connector
Typical part number:
SP2CDNKNANBNA4M0LN9A1

FEMALE CONNECTOR

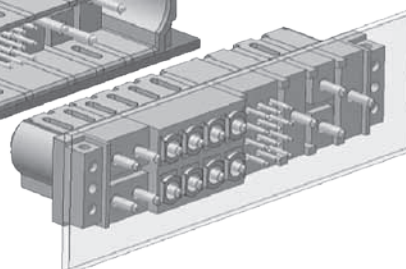

Female Straight PCB Mount
Connector
Typical part number:
SP2CDNKNANBNA3F009A1

MALE CONNECTOR

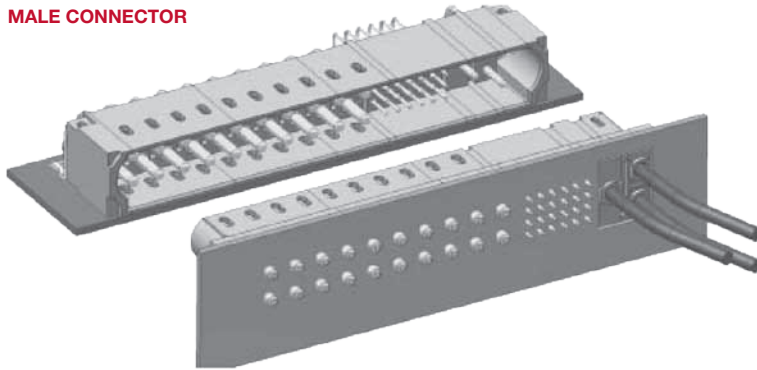

FEMALE CONNECTOR

Male Right Angle (90°) PCB Mount Connector
Typical part number:
SP2GGYNTN2ANB48MOLN9A1

Female Straight PCB Mount Connector with Crimp Contacts Pass-through
Typical part number:
SP2GGYNTN2ANB38F0N9A1-PA***
 (Crimp contacts ordered separately)

BOARD TO CABLE WITH CRIMP CONTACTS PASS-THROUGH

In Scorpion series, PCB mount and crimp contacts can be mixed in one insulator housing.

Consult sales for your unique requirements.

FEMALE CONNECTOR

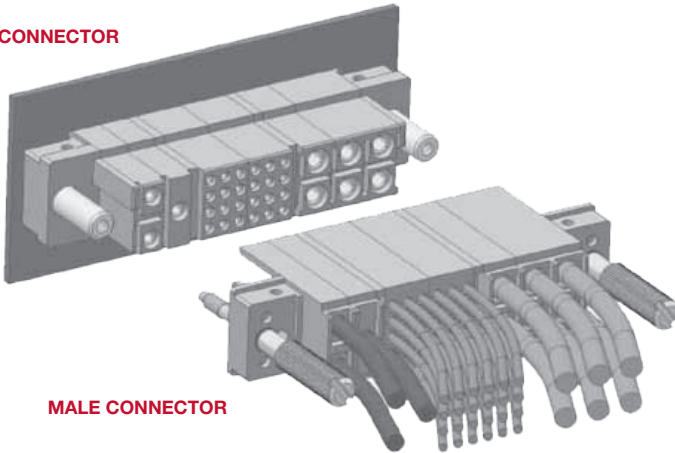

MALE CONNECTOR

Female Cable Connector
Typical part number:
SP6YENKKNAB3F0T0A1

Male Cable Connector
Typical part number:
SP6YENKKNAB1M0E01
 (Contacts ordered separately)

BOARD TO CABLE WITH JACKSCREW SYSTEM

MALE CONNECTOR

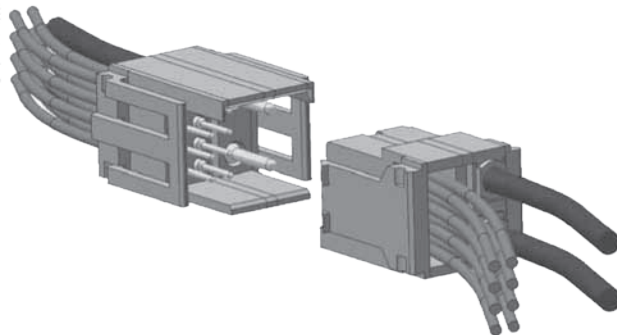

FEMALE CONNECTOR

Male Cable Connector
Typical part number:
SP3JNB1M0001
 (Contacts ordered separately)

Female Cable Connector
Typical part number:
SP3JNB1F0001
 (Contacts ordered separately)

CABLE TO CABLE WITH LOCKING LATCH SYSTEM

TEMPERATURE RISE CURVES

Tested per IEC Publication 512-3, Test 5a

SIZE 4

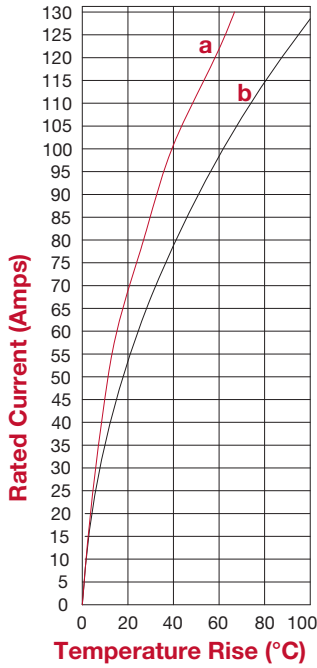

- a** Developed with 2 size 4 high conductivity contacts seated in code UU modules.
- b** Developed with 2 size 4 standard conductivity contacts seated in code UU modules.

SIZE 8

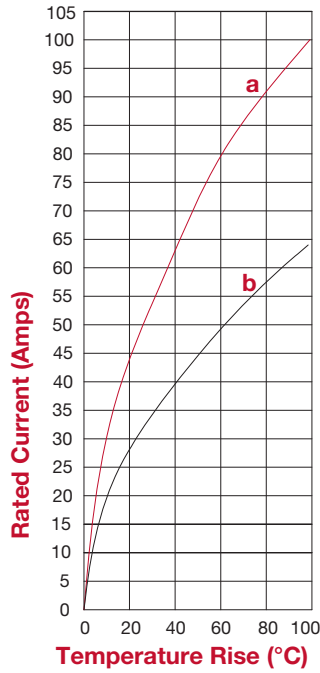

- a** Developed with 2 size 8 high conductivity contacts seated in code RR modules.
- b** Developed with 2 size 8 standard conductivity contacts seated in code RR modules.

SIZE 12

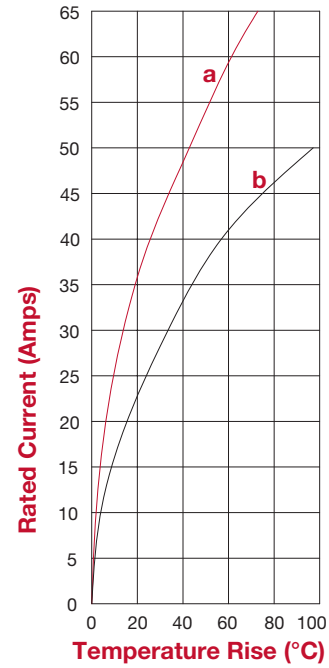

- a** Developed with 2 size 12 high conductivity contacts seated in code E module.
- b** Developed with 2 size 12 standard conductivity contacts seated in code E module.

SIZE 12

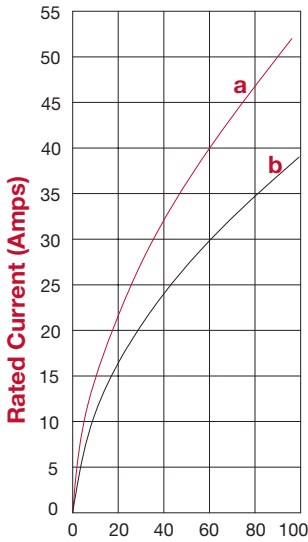

- a** Developed with 10 size 12 high conductivity contacts seated in code EYY modules.
- b** Developed with 10 size 12 standard conductivity contacts seated in code EYY modules.

SIZE 16

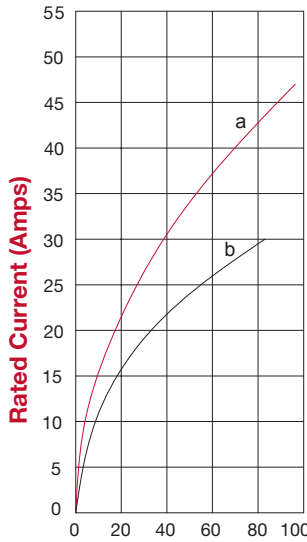

- a** Developed with 2 size 16 high conductivity contacts seated in code B module.
- b** Developed with 2 size 16 standard conductivity contacts seated in code B module.

SIZE 16

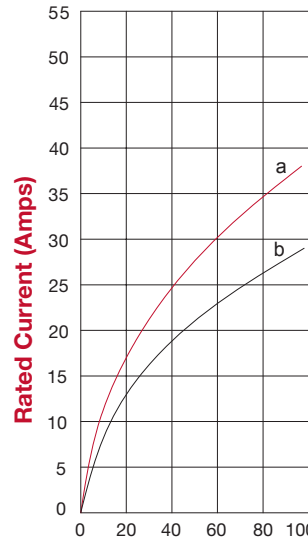

- a** Developed with 8 size 16 high conductivity contacts seated in code CC modules.
- b** Developed with 8 size 16 standard conductivity contacts seated in code CC modules.

SIZE 18

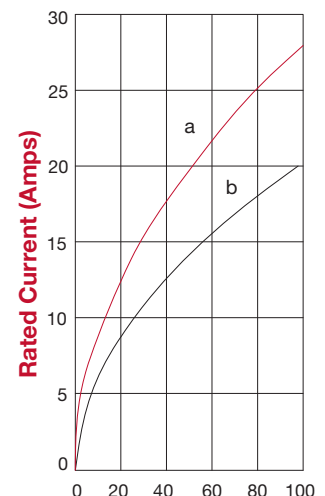

- a** Developed with 6 size 18 high conductivity contact seated in code Z module.
- b** Developed with 6 size 18 standard conductivity contact seated in code Z module.

Contact sales if additional testings and current ratings are required.

Dimension W

CODE	"W"
2	5.00 [0.197]
7	4.50 [0.177]

SUPER BLIND MATING GUIDE SYSTEM - SP1

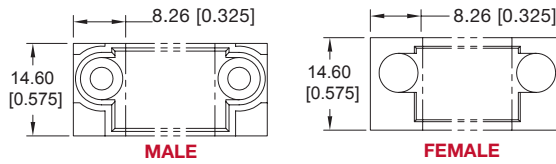

SP1
CODE 1 (STEP 2)

SP2
CODE 2 OR CODE 7
(STEP 2)

BLIND MATING GUIDE SYSTEM - SP2

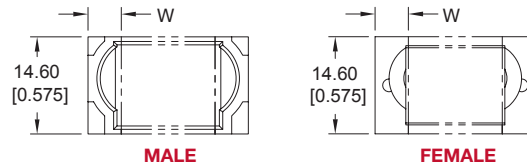

MALE CABLE TO FEMALE PANEL/BOARD LOCKING LATCH SYSTEM - SP4

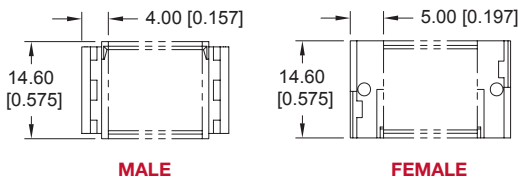

FEMALE CABLE TO MALE PANEL/BOARD LOCKING LATCH SYSTEM - SP5

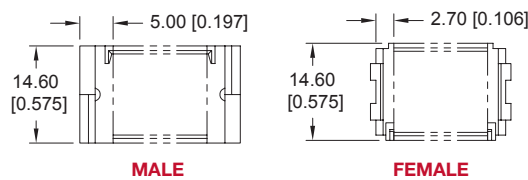

SP4
CODE 4 (STEP 2)

SP5
CODE 5 (STEP 2)

CABLE TO CABLE LOCKING LATCH SYSTEM - SP3

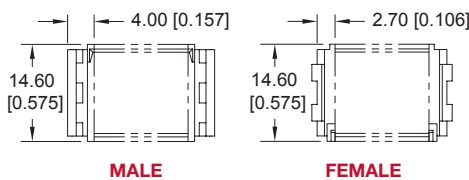

JACKSCREW SYSTEM - SP6

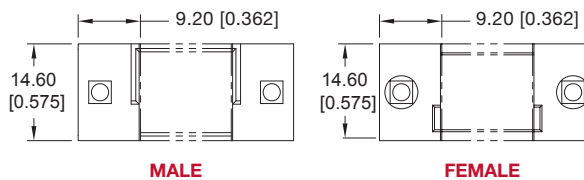

SP3
CODE 3 (STEP 2)

SP6
CODE 6 (STEP 2)

VENTING FEATURES

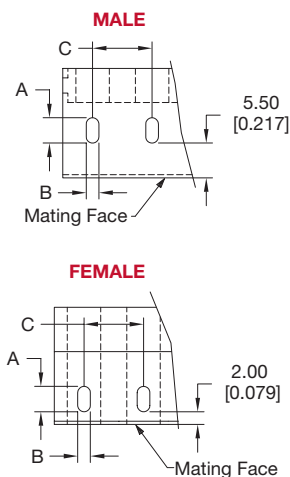

CONTACT SIZES	DIMENSION A	DIMENSION B	DIMENSION C
Size 4		2.00 [0.079]	14.20 [0.559]
Size 8		2.00 [0.079]	9.40 [0.370]
Size 12	4.00 [0.157]	2.00 [0.079]	5.90 [0.232]
Size 16		1.50 [0.059]	4.96 [0.195]
Size 18		1.50 [0.059]	3.80 [0.150]

CODE 9 (STEP 8)

Venting feature is an outlet hole enabling air cooling onto a power contact.

In compliance with UL 1977 safety standard, section 10.2 Accessibility of live parts.

(SEE STEP 3)

All modules shown on page 12 and 13 are male modules with the exception of size 22 precision formed female signal contact modules.

Consult sales for availability of other modules.

SIZE 4 POWER CONTACT MODULE

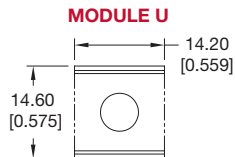

SIZE 8 POWER/SHIELDED CONTACT MODULES

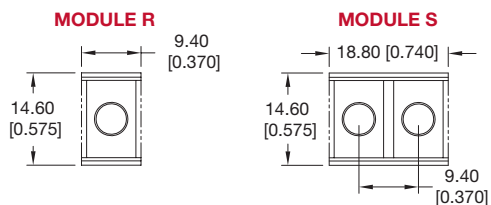

SIZE 12 POWER CONTACT MODULES

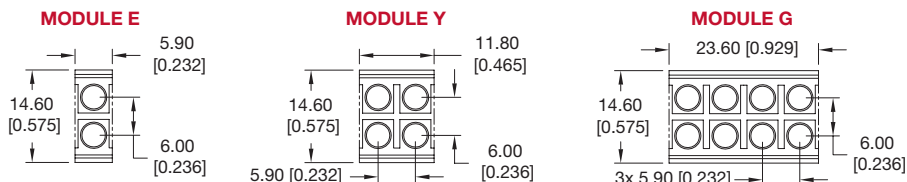

SIZE 16 POWER CONTACT MODULES

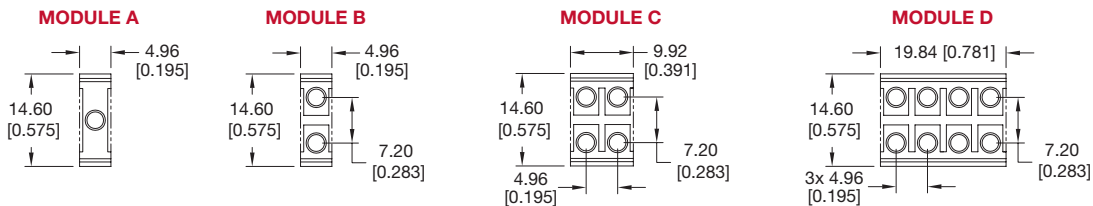

SIZE 18 POWER CONTACT MODULES

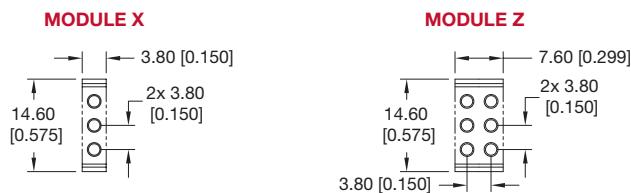

SIZE 22 SIGNAL CONTACT MODULES

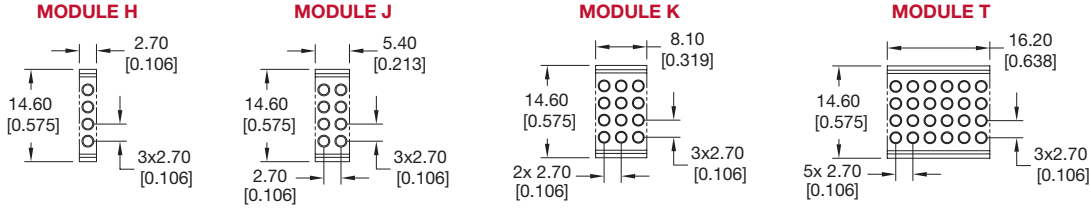

SIZE 22 PRECISION FORMED FEMALE SIGNAL CONTACT MODULES

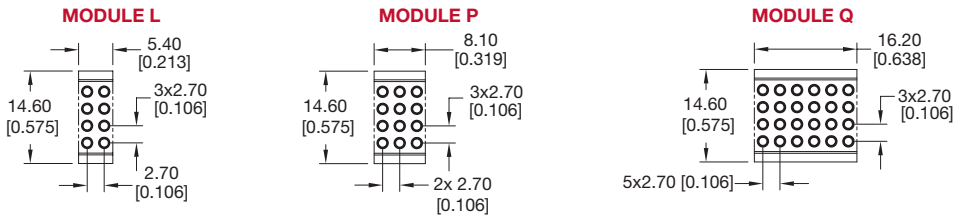

Available for Female Right Angle(90°) PCB mount termination.
Consult sales for availability of other termination.

HYPERBOLOID 0.60MM [0.0236] CONTACT MODULES

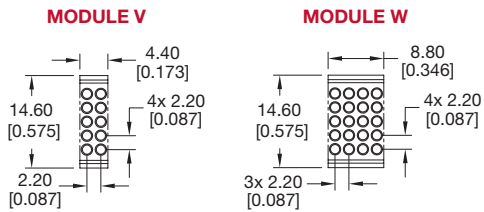

Available for PCB mount termination.
Consult sales for crimp contact terminations.

KEYING MODULES

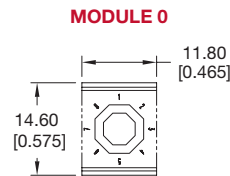

BLANK MODULES

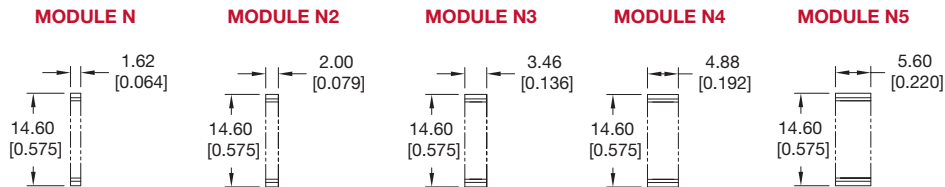

INSULATOR DIMENSIONS

DIMENSION A

To calculate OAL of Connector
See Example at Page 3
Overall Length Calculation

CONTACT MODULE	MALE	FEMALE
SIZE 4	8.83 [0.348]	9.40 [0.370]
SIZE 8	0	0
SIZE 12	2.20 [0.087]	3.20 [0.126]
SIZE 16	2.20 [0.087]	1.20 [0.126]
SIZE 18	0.60 [0.024]	0.60 [0.024]
SIZE 22	0	0

INSULATOR DIMENSIONS

WHEN USING
SUPER BLIND MATING
SYSTEM

CODE 1 (STEP 2)

**MALE INSULATOR FOR CABLE/
PANEL CONNECTOR**

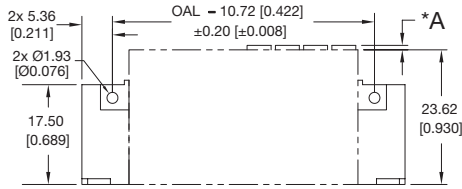

**FEMALE INSULATOR FOR CABLE/
PANEL CONNECTOR**

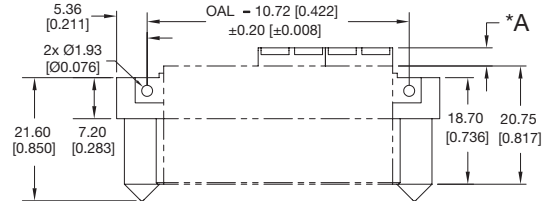

**MALE INSULATOR FOR
PCB MOUNT CONNECTOR**

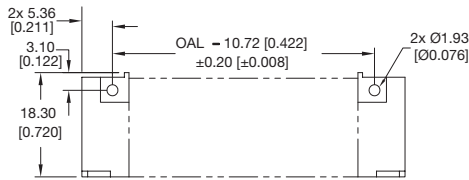

**FEMALE INSULATOR FOR
PCB MOUNT CONNECTOR**

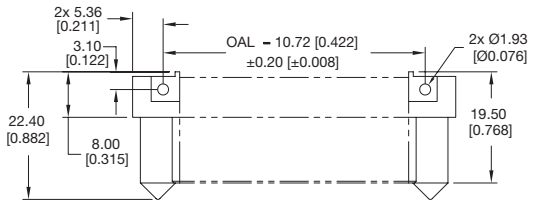

INSULATOR DIMENSIONS

WHEN USING
LOCKING LATCH SYSTEM

(SEE STEP 2)

**MALE INSULATOR FOR
CABLE CONNECTOR**



**FEMALE INSULATOR FOR
CABLE CONNECTOR**

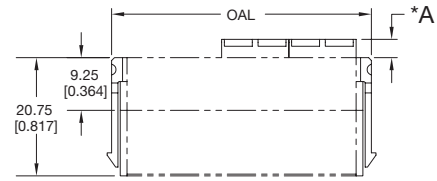

**MALE INSULATOR FOR
PANEL MOUNT CONNECTOR**

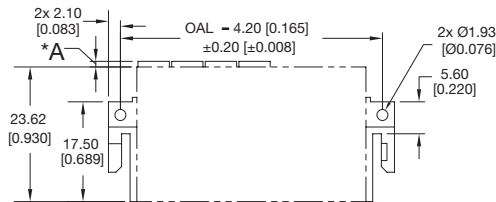

**FEMALE INSULATOR FOR
PANEL MOUNT CONNECTOR**

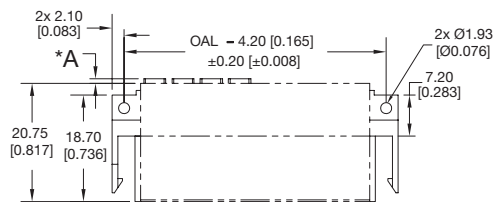

**MALE INSULATOR FOR
PCB MOUNT CONNECTOR**

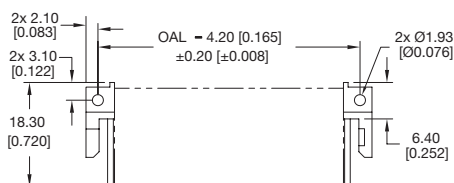

**FEMALE INSULATOR FOR
PCB MOUNT CONNECTOR**

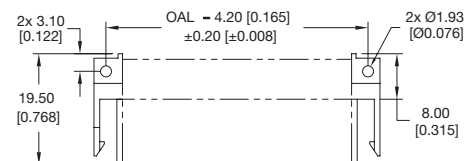

**MALE INSULATOR FOR CABLE/
PANEL CONNECTOR**

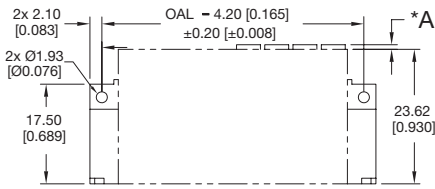

**MALE INSULATOR FOR
PCB MOUNT CONNECTOR**

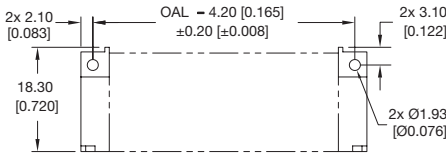

**FEMALE INSULATOR FOR CABLE/
PANEL CONNECTOR**

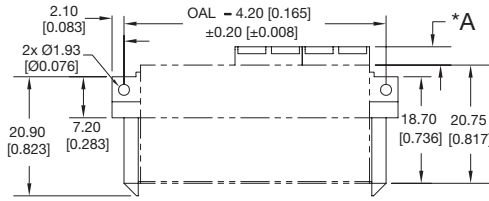

**FEMALE INSULATOR FOR
PCB MOUNT CONNECTOR**

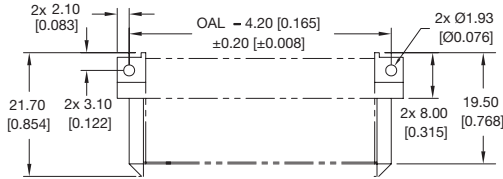

INSULATOR DIMENSIONS

WHEN USING
BLIND MATING SYSTEM

CODE 2 (STEP 2)

**MALE INSULATOR FOR CABLE/
PANEL CONNECTOR**

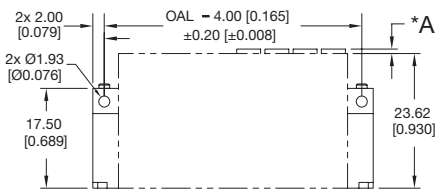

**MALE INSULATOR FOR
PCB MOUNT CONNECTOR**

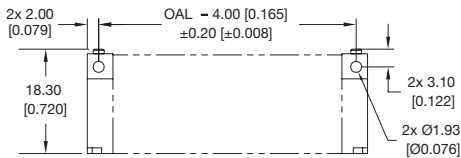

**FEMALE INSULATOR FOR CABLE/
PANEL CONNECTOR**

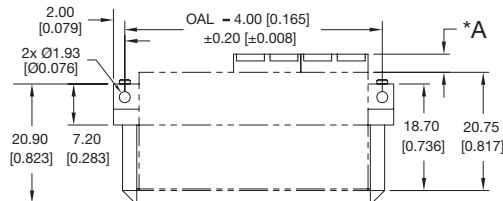

**FEMALE INSULATOR FOR
PCB MOUNT CONNECTOR**

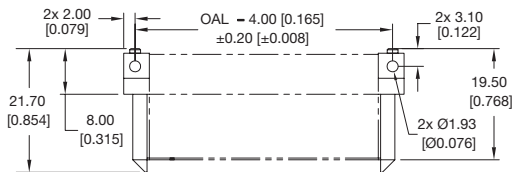

INSULATOR DIMENSIONS

WHEN USING
BLIND MATING SYSTEM

CODE 7 (STEP 2)

**MALE INSULATOR FOR CABLE/
PANEL CONNECTOR**

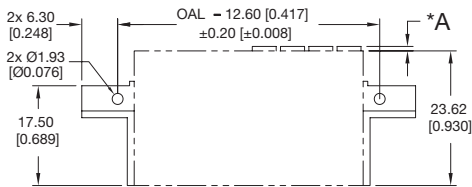

**MALE INSULATOR FOR
PCB MOUNT CONNECTOR**

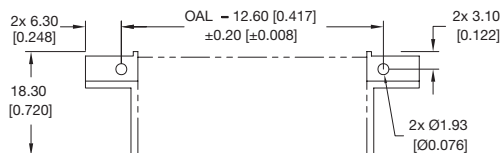

**FEMALE INSULATOR FOR CABLE/
PANEL CONNECTOR**

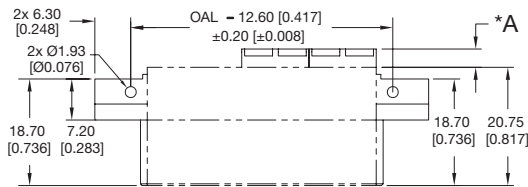

**FEMALE INSULATOR FOR
PCB MOUNT CONNECTOR**

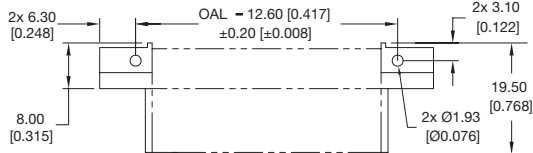

INSULATOR DIMENSIONS

WHEN USING
JACKSCREW SYSTEM

CODE 6 (STEP 2)

TERMINATION DIMENSIONS

STRAIGHT PCB MOUNT CONNECTORS

CODE 3 or CODE 38 (STEP 4)

Code 3 is standard conductive material contact and code 38 is high conductivity material power contact.

Dimensions apply to both precision machined and precision formed contacts

Male connector shown for reference. Dimensions also apply to female connector. Consult sales for Contact Hole Patterns of Straight PCB Mount Connectors.

SIZE 8 CONTACTS

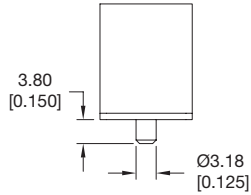

SIZE 12 CONTACTS

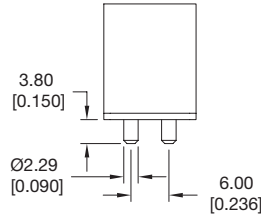

SIZE 16 CONTACTS DUAL ROW

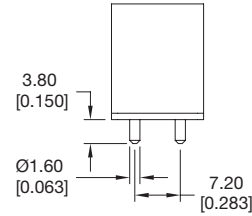

SIZE 16 CONTACTS SINGLE ROW

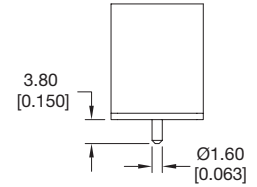

SIZE 18 CONTACTS

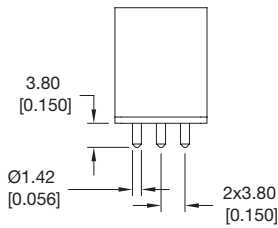

SIZE 22 CONTACTS

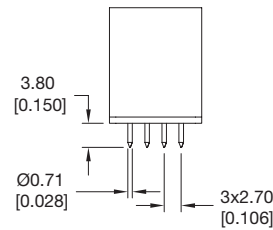

HYPERBOLOID 0.60MM [0.0236] CONTACTS

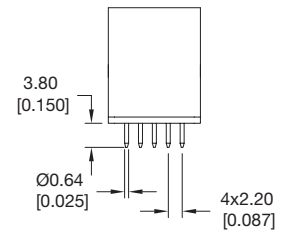

RIGHT ANGLE (90°) PCB MOUNT CONNECTORS

CODE 4 or CODE 48 (STEP 4)

Code 4 is standard conductive material contact and code 48 is high conductivity material power contact.

Dimensions apply to both precision machined and precision formed contacts

Male connector shown for reference. Dimensions also apply to female connector. Consult sales for Contact Hole Patterns of Right Angle (90°) PCB Mount Connectors.

SIZE 8 CONTACTS

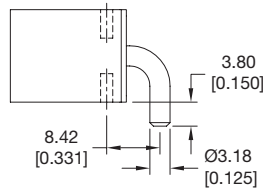

SIZE 12 CONTACTS

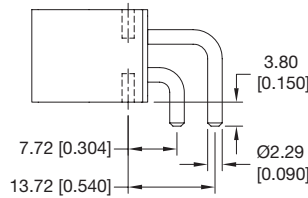

SIZE 16 CONTACTS DUAL ROW

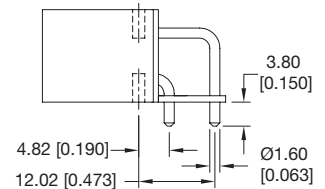

SIZE 16 CONTACTS SINGLE ROW

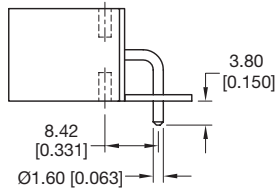

SIZE 18 CONTACTS

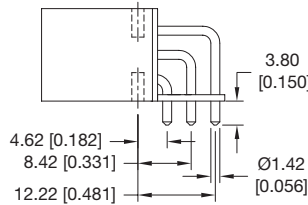

SIZE 22 CONTACTS

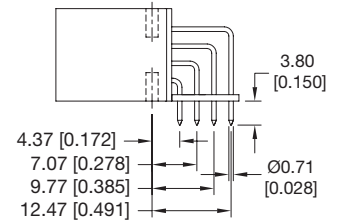

HYPERBOLOID 0.60MM [0.0236] CONTACTS

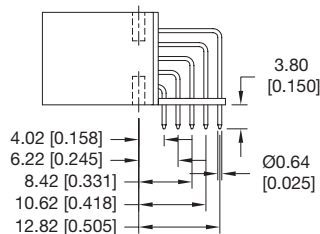

PRESS FIT DIMENSIONS

SIZE 8 CONTACTS

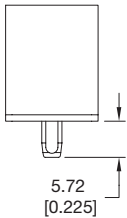

SIZE 12 CONTACTS

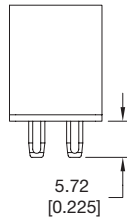

SIZE 16 CONTACTS DUAL ROW

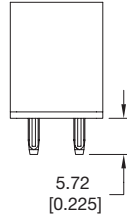

SIZE 16 CONTACTS SINGLE ROW

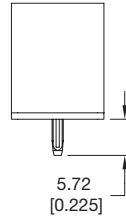

SIZE 22 CONTACTS

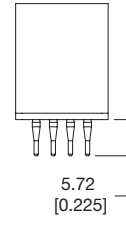

COMPLIANT PRESS-FIT STRAIGHT PCB MOUNT CONNECTORS

CODE 93 or 938 (STEP 4)

Code 93 is standard conductive material contact and code 938 is high conductivity material power contact.

Note: Outline dimensions for Press-Fit Connectors are the same as those of Straight PCB Mount Versions.

For Suggested Straight Mount PCB Holes Sizes of Compliant Press-Fit Connectors, for more informations. Please consult factory for SK6370.

Press-Fit User Information

Connectors-to-PCB installation instructions:

1. Choose the proper tooling. Insertion tooling and single contact repair tooling are available from Positronic.
2. Insert the connector into the PCB or backplane and seat connector fully with seating/ support tool.
3. Secure the connector to the PCB or backplane using two self-tapping screws for plastic.

Need to repair a single contact because of damage in manufacturing, testing, or field use?

1. Choose the proper contact extraction tool.
2. Push the contact out with a firm, steady force. Remember, excessive force is not required.
3. Install a new contact with the proper contact insertion tool. You are done.

Note: Please consult factory for Connector Installation Tool Ordering Part number.

MATING DIMENSIONS

STRAIGHT BOARD MOUNT OR PANEL MOUNT FEMALE TO STRAIGHT BOARD MOUNT OR PANEL MOUNT MALE

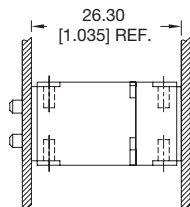

RIGHT ANGLE (90°) BOARD MOUNT FEMALE TO STRAIGHT BOARD MOUNT OR PANEL MOUNT MALE

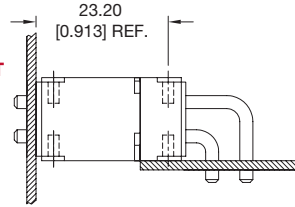

STRAIGHT BOARD MOUNT OR PANEL MOUNT FEMALE TO RIGHT ANGLE (90°) BOARD MOUNT MALE

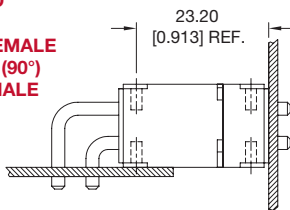

RIGHT ANGLE (90°) BOARD MOUNT FEMALE TO RIGHT ANGLE (90°) BOARD MOUNT MALE

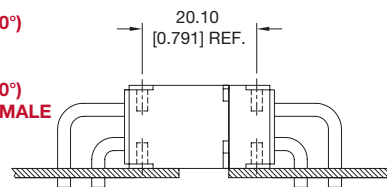

ACCESSORIES

THREADED INSERT

Threaded Insert with 2-56 UNC screw threads

Note:

- 1 Threaded Insert pre-installed at factory.
- 2 Material: Brass.
- 3 Specify using PA MOS Consult sales for special options.

For screw options, see page 26 on MOUNTING SCREW.



END MODULE WITH STABILIZER

(Applicable for Connector with mounting screw)

For screw mounting connector, End module with stabilizer will minimise PCB warpage. (For use with Code 3, 38, 93 and 938 in Step 4 of Part number definition). Available for SP2 end module. Consult sales for other end module.

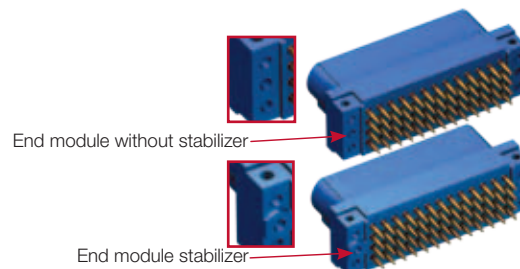

ACCESSORIES

ACCESSORIES FOR PCB MOUNT

(SEE STEP 7)

To calculate OAL of Connector
See Example at Page 3
Overall Length Calculation

DIMENSION B

MODULE TYPES	"B"
SUPER BLIND MATE	10.72 [0.422]
OTHERS	4.20 [0.165]



RIGHT ANGLE (90°) MOUNTING BRACKETS
CODE B (STEP 7)

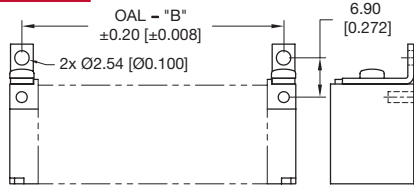

Material and Finish:: Brass with tin plate.

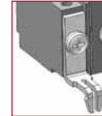

90° BOARD LOCK BRACKETS
CODE LN (STEP 7)

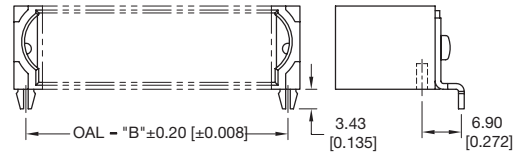

Material and Finish:: Brass with tin plate.
Male connector shown for reference only.



RIGHT ANGLE (90°) MOUNTING THREADED BRACKETS
CODE BS (STEP 7)

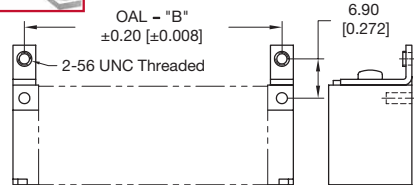

Material and Finish:: Brass with tin plate.
Consult sales for mounting screw information.
Male connector shown for reference only.

PUSH-ON FASTENERS
CODE N (STEP 7)

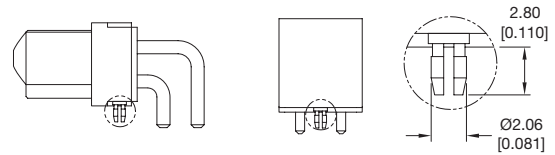

R/A (90°) PCB MOUNT

STRAIGHT PCB MOUNT

Material and Finish: Copper alloy with tin plate.

ACCESSORIES FOR PANEL MOUNT

(SEE STEP 6)

To calculate OAL of Connector
See Example at Page 3
Overall Length Calculation

DIMENSION B

MODULE TYPES	"B"
SUPER BLIND MATE	10.72 [0.422]
OTHERS	4.20 [0.165]

EASY RELEASE MOUNTING CLIPS
CODE 6 (STEP 6)

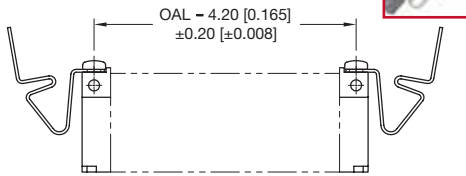

Material and Finish: Beryllium copper with nickel plate.



FLOAT MOUNT BUSHINGS
CODE 82 or 83 (STEP 6)

CODE 82 or 83 (STEP 6)

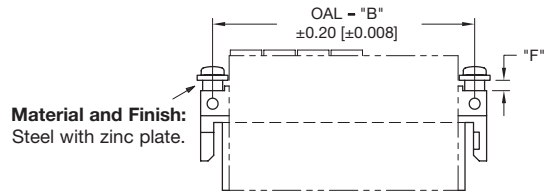

Material and Finish:
Steel with zinc plate.

CODE	PANEL THICKNESS	DIMENSION F
82	1.50 [0.059]	1.80 [0.071]
83	2.30 [0.091]	2.60 [0.102]

PANEL CUTOUT DIMENSIONS

General tolerance for panel cutout dimensions is ±0.13 [±0.005].

For screw options. See page 26 on MOUNTING SCREW

To calculate OAL of Connector
See Example at Page 3
Overall Length Calculation

DIMENSION B

MODULE TYPES	"B"
SUPER BLIND MATE	10.72 [0.422]
OTHERS	4.20 [0.165]

FOR MOUNTING SCREWS
CODE 0 (STEP 6)

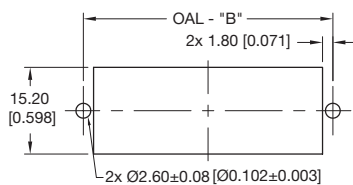

FOR QUICK RELEASE MOUNTING CLIP
CODE 6 (STEP 6)

Max. panel thickness:
1.60 [0.063] nominal

FOR FLOAT MOUNTING
CODE 82 or 83 (STEP 6)

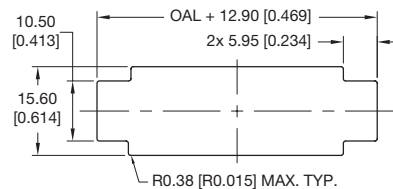
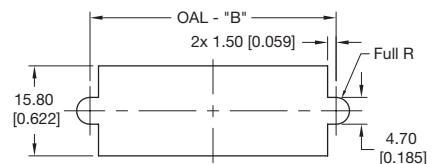

FEMALE FIXED JACKSCREW CODE T (STEP 7)

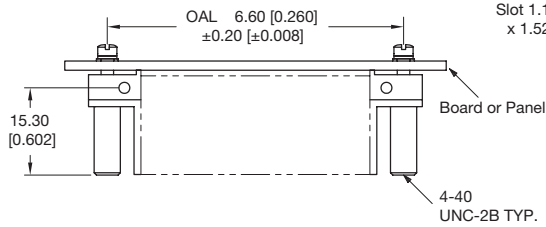

MALE TURNABLE JACKSCREW CODE E (STEP 7)

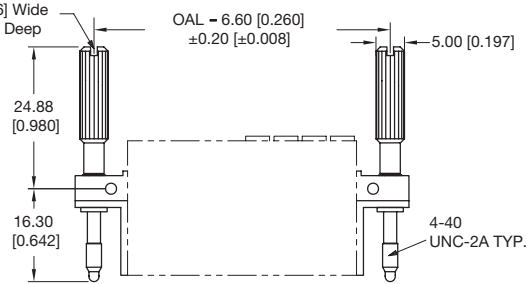

(SEE STEP 7)

Material:

Jackscrews, Hex Nut and Lockwashers
- Stainless Steel, Passivated.

Knob - Aluminium, Yellow Anodized.

*Male connector shown for reference.
Contact sales about ordering
components separately.*

*To calculate OAL of Connector
See Example at Page 3
Overall Length Calculation*

FEMALE FIXED JACKSCREW WITH RIGHT ANGLE (90°) MOUNTING BRACKETS CODE TB (STEP 7)

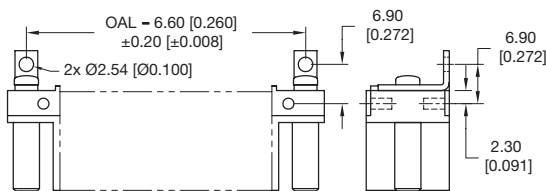

FEMALE FIXED JACKSCREW WITH RIGHT ANGLE (90°) BOARD LOCK BRACKETS CODE TLN (STEP 7)

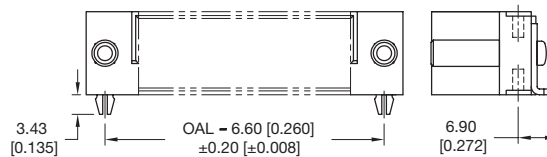

ACCESSORIES FOR USE WITH JACKSCREW SYSTEM

(SEE STEP 7)

Material:

Jackscrews, Hex Nut and Lockwashers
- Stainless Steel, Passivated.

*Male connector shown for reference.
Contact sales about ordering
components separately.*

*To calculate OAL of Connector
See Example at Page 3
Overall Length Calculation*

FEMALE FIXED JACKSCREW WITH PUSH-ON FASTENERS CODE TN (STEP 7)

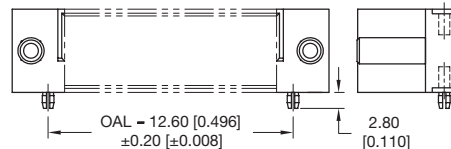
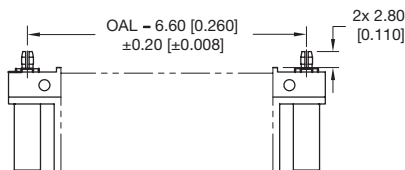

STRAIGHT PCB MOUNT CONNECTOR

RIGHT ANGLE (90°) PCB MOUNT CONNECTOR

FOR MOUNTING SCREWS CODE 0 (STEP 6)

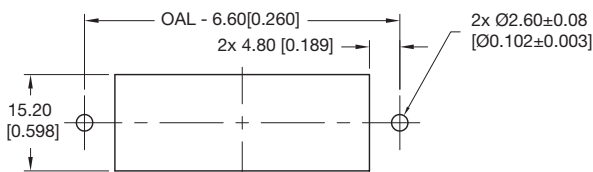

FOR FLOAT MOUNTING CODE 82 or 83 (STEP 6)

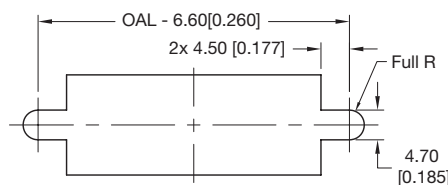

PANEL CUTOUT DIMENSIONS WHEN USING WITH JACKSCREW SYSTEM

(SEE STEP 6)

General tolerance for panel cutout
dimensions is ± 0.13 [± 0.005].

*To calculate OAL of Connector
See Example at Page 3
Overall Length Calculation*

MODULAR HOOD

APPLICABLE FOR CONNECTOR WITH N5 SPACER ONLY

MATERIALS AND FINISHES

Hood	Glass-filled polyester, UL 94V-0. Blue color.
Hood Screws	Steel, zinc plate with chromate seal.
Cable clamp	Steel with nickel plate.
Cable Clamp Screws	Brass, zinc plate with chromate seal. (Consult sales for Hood availability).

SCORPION HOODS ARE MOLDED WITH THE FOLLOWING MODULES:

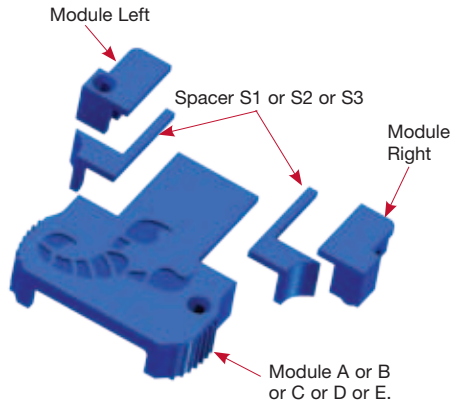

Scorpion Hood: Dimension and Ordering part number, please refer to ASK23100. Consult sales for Hood availability.

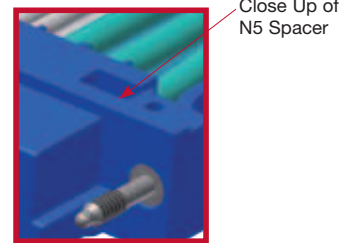
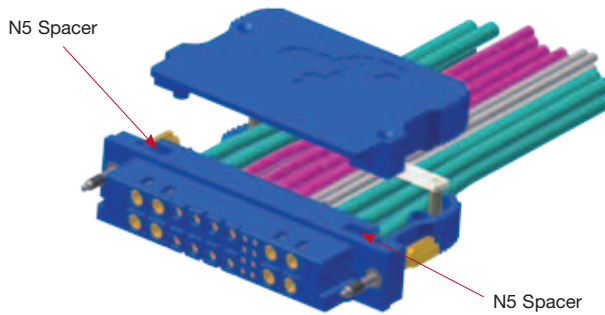

Note: N5 Spacer (for Hood application, place N5 spacer next to End module).

**HOOD WITH JACKSCREW
CODE WE (STEP 7)**

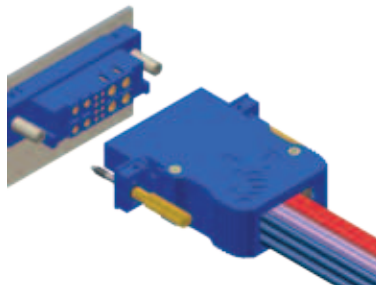

**HOOD WITHOUT JACKSCREW
CODE W (STEP 7)**

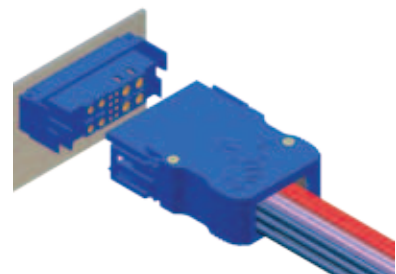

HOOD WITH CABLE CLAMP

Minimise wire skewing inside the hood

APPLICABLE FOR
CONNECTOR WITH
N5 SPACER ONLY

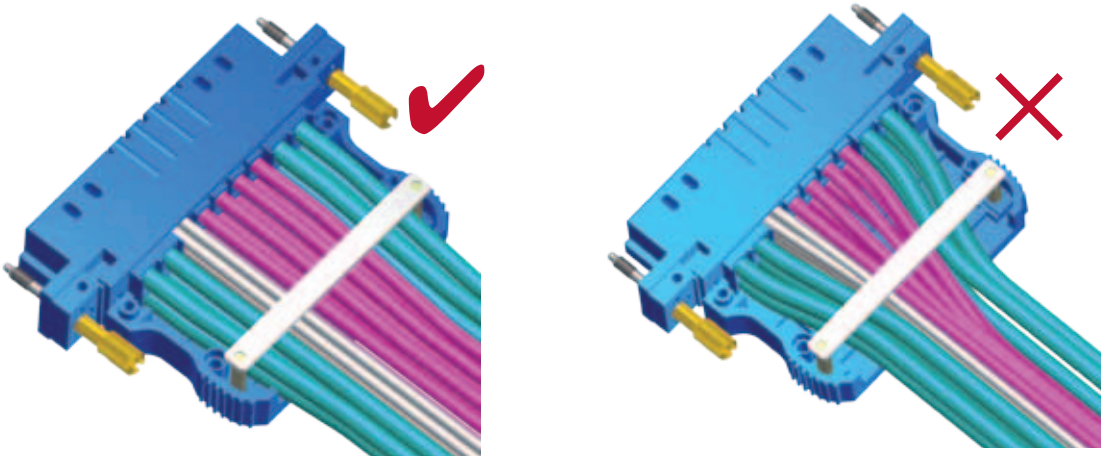

APPLICATION WITHOUT HOOD

Removable contacts should be allowed to float after installation in the connector body. This enables superior mating performance. Therefore, wires must remain approximately perpendicular to the connector for a recommended minimum distance. See diagram.

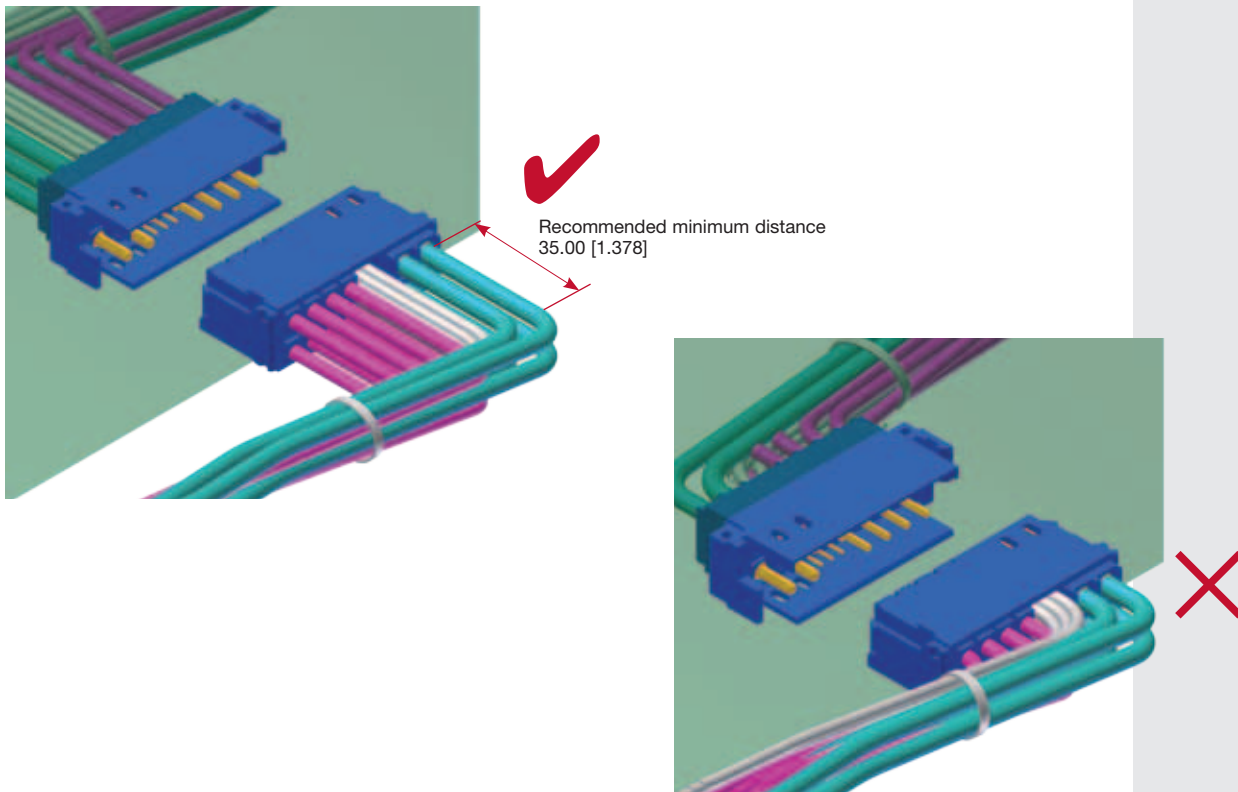

APPLICATION RECOMMENDATION:

Positronic recommends do not bend wires on a crimp version at a sharp angle

CONTACTS

Material and Finishes:

Precision machined copper alloy with gold flash over nickel.

Consult sales for other contact sizes, materials, finishes, termination styles and more details.

Note:

Please use correct wire size and it should be smaller than ØA of the contact. Some connectors may not accommodate some thicker insulation wires. Customer review for wire selection is recommended. Removable contacts should be allowed to float after installation in connector body. This enables superior mating performance. If floating is not enabled, some mating issues may occur; especially when wires/cables are bent at a severe angle.

SIZE 4 REMOVABLE CRIMP CONTACTS

(Contacts Ordered Separately)

PART NUMBER (STANDARD CONDUCTIVITY CONTACTS)	PART NUMBER (HIGH CONDUCTIVITY CONTACTS)	WIRE SIZE AWG [mm²]	ØA
--	--	---------------------	----

FEMALE CONTACTS

FC0404N2	FC0404N2S	4 [25.0]	7.40 [0.291]
----------	-----------	----------	--------------

MALE CONTACTS

MC0404N	MC0404NS	4 [25.0]	7.40 [0.291]
---------	----------	----------	--------------

FEMALE

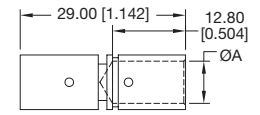

MALE

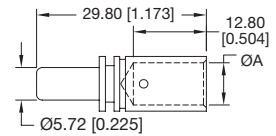

SIZE 4 REMOVABLE CONTACTS, BUS BAR INTERNAL THREADS

(Contacts Ordered Separately)

PART NUMBER (STANDARD CONDUCTIVITY CONTACTS)	PART NUMBER (HIGH CONDUCTIVITY CONTACTS)	THREAD T
--	--	----------

FEMALE CONTACTS

SPFIT04M	SPFIT04MS	M5 x 0.8
SPFIT04S	SPFIT04SS	10-24 UNC 2B

MALE CONTACTS

SPMIT04M	SPMIT04MS	M5 x 0.8
SPMIT04S	SPMIT04SS	10-24 UNC 2B

FEMALE

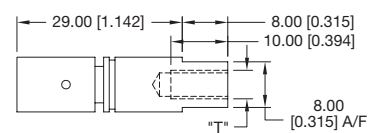

MALE

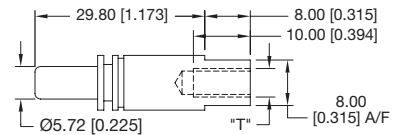

SIZE 4 REMOVABLE CONTACTS, BUS BAR EXTERNAL THREADS

(Contacts Ordered Separately)

PART NUMBER (STANDARD CONDUCTIVITY CONTACTS)	PART NUMBER (HIGH CONDUCTIVITY CONTACTS)	THREAD T
--	--	----------

FEMALE CONTACTS

SPFET04M	SPFET04MS	M5 x 0.8
SPFET04S	SPFET04SS	10-24 UNC 2A

MALE CONTACTS

SPMET04M	SPMET04MS	M5 x 0.8
SPMET04S	SPMET04SS	10-24 UNC 2A

FEMALE

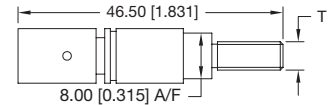

MALE

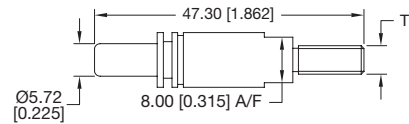

SIZE 4 REMOVABLE CONTACTS, RIGHT ANGLE THREAD FOR TYPICAL RING TERMINAL

(Contacts Ordered Separately)

PART NUMBER (STANDARD CONDUCTIVITY CONTACTS)	PART NUMBER (HIGH CONDUCTIVITY CONTACTS)	THREAD T	WIRE SIZE AWG [mm²]
--	--	----------	---------------------

FEMALE CONTACTS

SPFRA04M	SPFRA04MS	M5 x 0.8	10 [5.3]
SPFRA04S	SPFRA04SS	10-24 UNC 2B	10 [5.3]

MALE CONTACTS

SPMRA04M	SPMRA04MS	M5 x 0.8	10 [5.3]
SPMRA04S	SPMRA04SS	10-24 UNC 2B	10 [5.3]

FEMALE

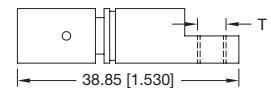

MALE

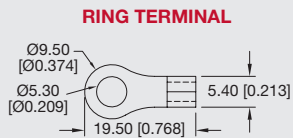
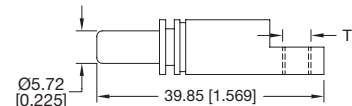

Shown for reference only

SIZE 8 REMOVABLE CRIMP CONTACTS *(Contacts Ordered Separately)*

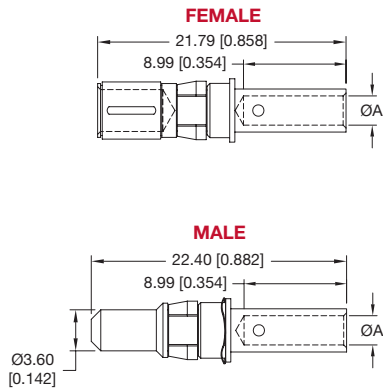

PART NUMBER (STANDARD CONDUCTIVITY CONTACTS)	PART NUMBER (HIGH CONDUCTIVITY CONTACTS)	WIRE SIZE AWG [mm ²]	ØA
FEMALE CONTACTS			
N/A	FC4008DS	8 [10.0]	4.60 [0.181]
FC4010D	N/A	10 [5.3]	3.10 [0.122]
FC4012D		12 [4.0]	2.57 [0.101]
FC4016D		16 [1.5]	1.70 [0.067]
MALE CONTACTS			
N/A	MC4008DS	8 [10.0]	4.60 [0.181]
MC4010D	N/A	10 [5.3]	3.10 [0.122]
MC4012D		12 [4.0]	2.57 [0.101]
MC4016D		16 [1.5]	1.70 [0.067]

N/A - Not Applicable

Material and Finishes:

Precision machined copper alloy with gold flash over nickel.

Consult sales for other contact sizes, materials, finishes, termination styles and more details.

Note:

Please use correct wire size and it should be smaller than ØA of the contact. Some connectors may not accommodate some thicker insulation wires. Customer review for wire selection is recommended. Removable contacts should be allowed to float after installation in connector body. This enables superior mating performance. If floating is not enabled, some mating issues may occur; especially when wires/cables are bent at a severe angle.

SIZE 12 REMOVABLE CRIMP CONTACTS *(Contacts Ordered Separately)*

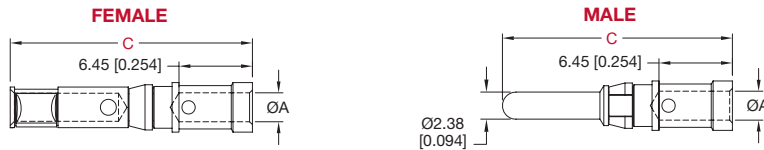

PART NUMBER (STANDARD CONDUCTIVITY CONTACTS)	PART NUMBER (HIGH CONDUCTIVITY CONTACTS)	WIRE SIZE AWG [mm ²]	ØA	SEQUENTIAL MATE	C
FEMALE CONTACTS					
FC1210P2	FC1210P2S	10 [6.0]	3.10 [0.122]	N/A	21.25 [0.837]
FC1212P2	FC1212P2S	12 [4.0]	2.54 [0.100]		
MALE CONTACTS					
MC1210N-PA563	MC1210NS-PA563	10 [6.0]	3.10 [0.122]	FIRST	23.18 [0.912]
MC1210N	MC1210NS			STANDARD	20.18 [0.794]
MC1212N-PA563	MC1212NS-PA563	12 [4.0]	2.54 [0.100]	FIRST	23.18 [0.912]
MC1212N	MC1212NS			STANDARD	20.18 [0.794]

N/A - Not Applicable

SIZE 16 REMOVABLE CRIMP CONTACTS *(Contacts Ordered Separately)*

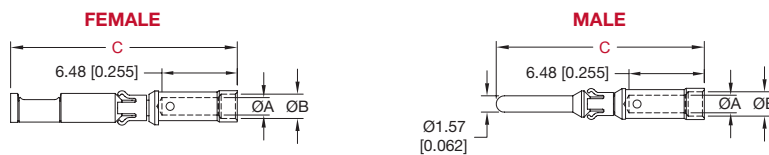

PART NUMBER (STANDARD CONDUCTIVITY CONTACTS)	PART NUMBER (HIGH CONDUCTIVITY CONTACTS)	WIRE SIZE AWG [mm ²]	ØA	ØB	SEQUENTIAL MATE	C
FEMALE CONTACTS						
FC112P2-PA907	FC112P2S-PA907	12 [4.0]	2.49 [0.098]	N/A	N/A	19.33 [0.761]
FC114P2-PA907	N/A	14-16 [2.5-1.5]	2.06 [0.081]	2.67 [0.105]		
FC116P2-PA907		16-18-20 [1.5-1.0-0.5]	1.70 [0.067]	2.36 [0.093]		
FC120P2-PA907		20-22-24 [0.5-0.3-0.25]	1.14 [0.045]	1.73 [0.068]		
MALE CONTACTS						
MC112N-133.5	MC112NS-133.5	12 [4.0]	2.49 [0.098]	N/A	FIRST	21.74 [0.856]
MC112N	MC112NS				STANDARD	19.41 [0.764]
MC114N-133.5	N/A	14-16 [2.5-1.5]	2.06 [0.081]	2.67 [0.105]	FIRST	21.74 [0.856]
MC114N					STANDARD	19.41 [0.764]
MC116N-133.5		FIRST	21.74 [0.856]			
MC116N		STANDARD	19.41 [0.764]			
MC120N-133.5		FIRST	21.74 [0.856]			
MC120N		STANDARD	19.41 [0.764]			

N/A - Not Applicable

Material and Finishes:

Precision machined copper alloy with gold flash over nickel.

Consult sales for other contact sizes, materials, finishes, termination styles and more details.

Note:

Please use correct wire size and it should be smaller than ØA of the contact. Some connectors may not accommodate some thicker insulation wires. Customer review for wire selection is recommended. Removable contacts should be allowed to float after installation in connector body. This enables superior mating performance. If floating is not enabled, some mating issues may occur; especially when wires/cables are bent at a severe angle.

SIZE 18 REMOVABLE CRIMP CONTACTS

(Contacts Ordered Separately)



PART NUMBER (STANDARD CONDUCTIVITY CONTACTS)	PART NUMBER (HIGH CONDUCTIVITY CONTACTS)	WIRE SIZE AWG [mm ²]	ØA	ØB	ØD	SEQUENTIAL MATE	C
FEMALE CONTACTS							
FC1816P2	FC1816P2S	16-18 [1.5-1.0]	1.70 [0.067]	1.70 [0.067]	2.43 [0.096]	N/A	19.34 [0.761]
FC1820P2	FC1820P2S	20 [0.5]	1.14 [0.045]	1.73 [0.068]	1.73 [0.068]		
MALE CONTACTS							
MC1816N-PA561	MC1816NS-PA561	16-18 [1.5-1.0]	1.70 [0.067]	1.70 [0.067]	2.43 [0.096]	FIRST	21.08 [0.830]
MC1816N	MC1816NS					STANDARD	19.08 [0.751]
MC1820N-PA561	MC1820NS-PA561	20 [0.5]	1.14 [0.045]	1.73 [0.068]	1.73 [0.068]	FIRST	21.08 [0.830]
MC1820N	MC1820NS					STANDARD	19.08 [0.751]

N/A - Not Applicable

SIZE 22 REMOVABLE CRIMP CONTACTS

(Contacts Ordered Separately)

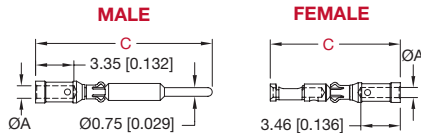

SIZE 22 NON REMOVABLE CRIMP CONTACTS

(Contacts Ordered Separately)

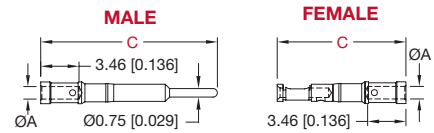

REMOVABLE CONTACT	NON REMOVABLE CONTACT	WIRE SIZE AWG [mm ²]	ØA	C
FEMALE CONTACTS				
FC422P9	FC422T-PA908	22 - 26 [0.3-0.12]	0.89 [0.035]	11.41 [0.449]
MALE CONTACTS				
MC422N9	MC422T-PA908	22 - 26 [0.3-0.12]	0.89 [0.035]	15.49 [0.610]

N/A - Not Applicable

HYPERBOLOID 0.6MM NON REMOVABLE CRIMP CONTACTS

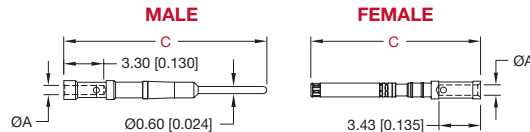

NON REMOVABLE CONTACT	WIRE SIZE AWG [mm ²]	ØA	C
FEMALE CONTACTS			
FC3124T	24 - 28 [0.25-0.08]	0.86 [0.034]	13.96 [0.550]
MALE CONTACTS			
MC3124T	24 - 28 [0.25-0.08]	0.76 [0.030]	16.70 [0.657]

N/A - Not Applicable

Materials and Finishes:

Precision machined copper alloy with gold flash over nickel.

Consult sales for other contact sizes, materials, finishes, termination styles and more details.

SHIELDED CONTACTS, REMOVABLE SIZE 8
(Contacts Ordered Separately)

CODE 1 (STEP 4)

ELECTRICAL CHARACTERISTICS

Initial Contact Resistance	0.008 ohms, maximum.
Nominal Impedance	50 ohms.
* Insertion Loss	-0.46 dB at 1 GHz -1.5 dB at 2 GHz
* VSWR	Contact technical sales
* Proof Voltage	1000 V r.m.s.

* Above values measured using frequency domain techniques.

MATERIALS AND FINISHES

Copper alloy with PTFE teflon insulator.	
Signal Contact	0.76 μ [0.000030] gold over nickel.
Contact Body:	Gold flash over nickel.

OPTIONAL FINISHES

Signal Contact	1.27 μ [0.000050] gold over nickel. by adding "-15" suffix onto part number. Example: MS4102D-15.
Contact Body	0.76 μ [0.000030] gold flash over nickel.

Contact sales for more shielded contact options, high voltage contacts, air line couples, more technical characteristics, soldering and crimping information.

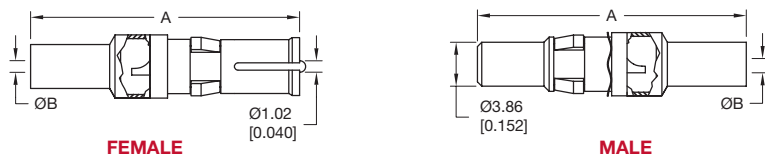
SIZE 8 STRAIGHT SOLDER/ CRIMP CONTACTS

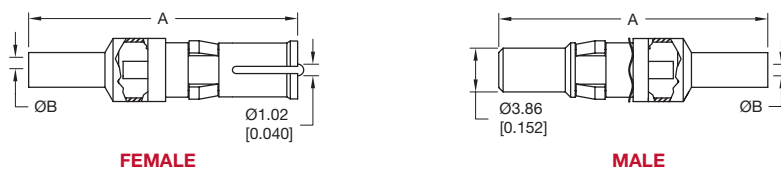
FEMALE
MALE
SIZE 8 STRAIGHT SOLDER/ SOLDER CONTACTS

FEMALE
MALE
SIZE 8 STRAIGHT CRIMP/ CRIMP CONTACTS

FEMALE
MALE

CONTACTS

SHIELDED CONTACTS, REMOVABLE SIZE 8 Cont'

(Contacts Ordered Separately)

SOLDER / CRIMP PART NUMBER		SOLDER / SOLDER PART NUMBER		CRIMP / CRIMP PART NUMBER		A	ØB	RG CABLE NUMBER
MALE	FEMALE	MALE	FEMALE	MALE	FEMALE			
MC4101D	FC4101D	MS4101D	FS4101D	MCC4101D	FCC4101D	23.60 [0.929]	1.02 [0.040]	178 B/U 196 B/U
MC4102D	FC4102D	MS4102D	FS4102D	MCC4102D	FCC4102D	23.60 [0.929]	1.70 [0.067]	179 B/U 316 B/U
MC4103D	FC4103D	MS4103D	FS4103D	MCC4103D	FCC4103D	26.34 [1.037]	2.74 [0.108]	180 B/U
MC4104D	FC4104D	MS4104D	FS4104D	MCC4104D	FCC4104D	26.34 [1.037]	3.05 [0.120]	58 B/U

SHIELDED CONTACT HAND CRIMP TOOL



Typical part number:
FC4101D

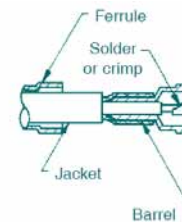

MOUNTING SCREWS

SELF TAPPING SCREW See page 18 PANEL CUTOUT DIMENSION under ACCESSORIES	MATERIAL OPTIONS	PART NUMBER	THREAD LENGTH	RECOMMENDED P.C. BOARD THICKNESS <i>When applicable</i>
	Steel	4546-7-1-16	6.35±0.76 [0.250±0.030]	2.36 [0.093]
	Steel	4546-7-2-16	7.93±0.76 [0.312±0.030]	3.18 [0.125]
	Steel	4546-7-3-16	9.53±0.76 [0.375±0.030]	4.45 [0.175]
	Stainless Steel	4546-7-6-4	6.35±0.76 [0.250±0.030]	2.36 [0.093]
	Stainless Steel	4546-7-7-4	7.93±0.76 [0.312±0.030]	3.18 [0.125]
	Stainless Steel	4546-7-8-4	9.53±0.76 [0.375±0.030]	4.45 [0.175]

SCREW 2-56 UNC-2A (USE WITH THREADED INSERT) See page 17 THREADED INSERT under ACCESSORIES	MATERIAL OPTIONS	PART NUMBER	THREAD LENGTH	RECOMMENDED P.C. BOARD THICKNESS <i>When applicable</i>
	Steel	2074-12-1-16	6.81±0.76 [0.268±0.030]	2.36 [0.093]
	Steel	2074-12-2-16	7.63±0.76 [0.300±0.030]	3.18 [0.125]
	Steel	2074-12-3-16	8.90±0.76 [0.350±0.030]	4.45 [0.175]
	Stainless Steel	2074-12-4-4	6.81±0.76 [0.268±0.030]	2.36 [0.093]
	Stainless Steel	2074-12-5-4	7.63±0.76 [0.300±0.030]	3.18 [0.125]
	Stainless Steel	2074-12-6-4	8.90±0.76 [0.350±0.030]	4.45 [0.175]

**RECOMMENDED
TOOLS FOR
CRIMP CONTACTS.**

Contact Extraction Tool

Contact Insertion Tool

**Cycle-Controlled Step
Adjustable Hand Crimp Tool**

Size 4 Hand Crimp Tool

CONTACT SIZE	CONTACT EXTRACTION TOOL	CONTACT INSERTION TOOL	HAND CRIMP TOOL
Size 4	Not Applicable	Not Applicable	9509-7-0 (FC0404** and MC0404** contacts)
Size 8	4311-0-2	Not Applicable	9504-19-0 (FC4008DS and MC4008DS contacts) 9509-0-0 (*C4010D, *C4012D, and *C4016D contacts)
Size 12	2711-0-0	9099-3-0	9509-6-1 with 9509-6-2 positioner (*C1210** contacts) 9501-0 with 9502-38-0 positioner (MC1212** contacts) 9501-0 with 9502-37-0 positioner (FC1212** contacts)
Size 16	9081-0-0	9099-0-0	9501-0 with 9502-1-0 positioner (FC1**P2, MC1**N) 9501-0 with 9502-17-0 positioner (MC1**N-133.5) 9509-3 (FC112N2S, MC112NS and MC112NS-133.5)
Size 18	9081-9-0	9099-6-0	9507-0 with 9502-32-0 positioner (male contacts) 9507-0 with 9502-30-0 positioner (female contacts)
Size 22	^ 9081-3-0	9099-7-0	9507-0 with 9502-12-0 positioner (male contacts) 9507-0 with 9502-13-0 positioner (female contacts)
Hyperboloid 0.6mm	Not Applicable	9512-106-0	9507-0 with 9502-40-0 positioner (male contacts) 9507-0 with 9502-46-0 positioner (female contacts)

^ Not Applicable for Size 22 non-removable crimp contacts.
Consult sales for additional crimping tools and crimping information.

LOCKING CLIP

INSERTION, EXTRACTION, AND RETENTION OF SIZE 4 CONTACTS

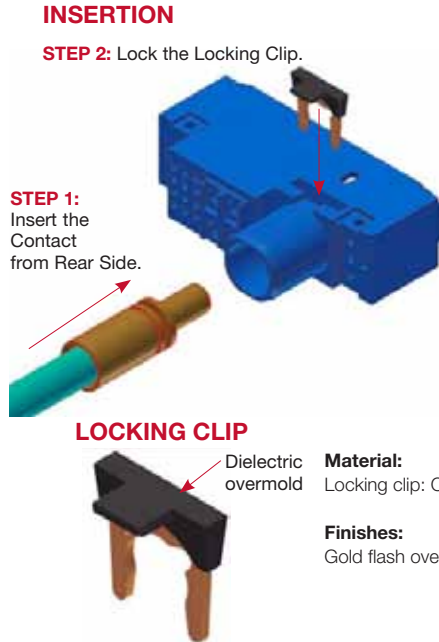

Material:
Locking clip: Copper alloy with Nylon, UL 94V-0 dielectric overmold, black color.

Finishes:
Gold flash over nickel plate.

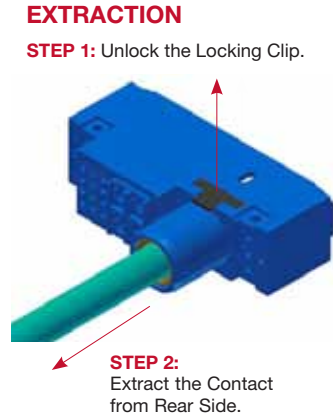

KEYING MODULE AND PLUG

CODE 2 (STEP 3)

Note:

- 1 Material:**
Glass-filled polyester, UL 94V-0, Color: Blue.
- 2** Default factory setting for keying plug on keying module is at position 1.
- 3** There are 8 available positions for customer to choose from. Customer can change the position by using Male Insertion tool / Extraction tool for Male Plug, Female Insertion tool / Extraction tool for Female Plug.

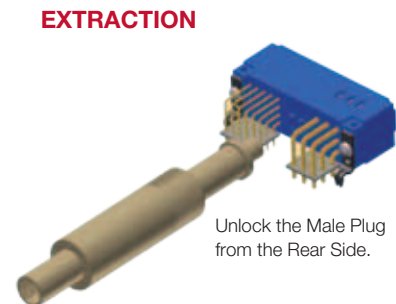
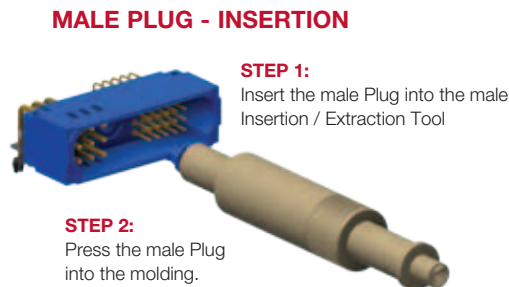
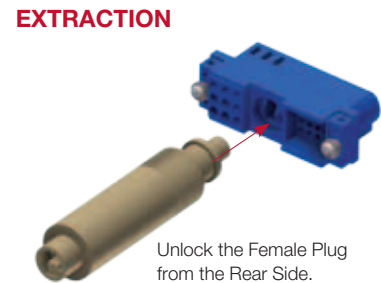
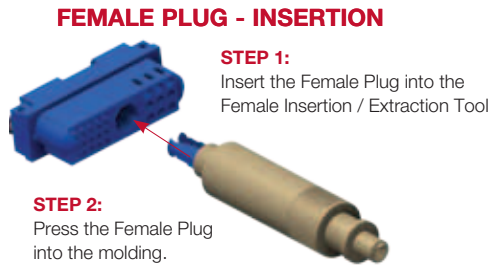
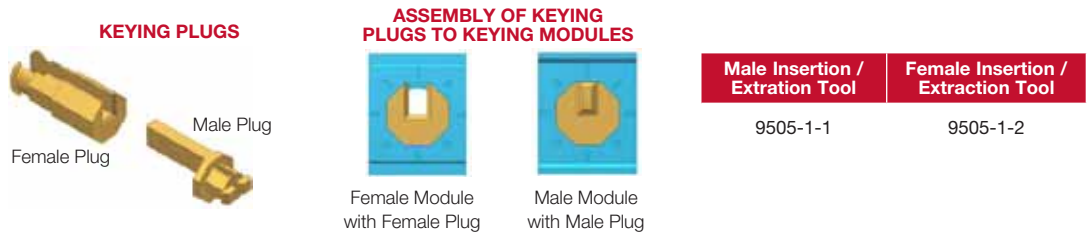

RECOMMENDED CRIMPING PROCEDURE FOR SIZE 4 CONTACTS.

- 1 Strip cable and insert in contact crimp barrel. Ensure that all of the conductor wire strands are captured within crimp barrel and that the cable conductor wire is visible through inspection hole.
- 2 Lift the movable handle to open the die head, place the contact with cable inside hexagonal die, ensure that the end face of contact is touching the stopper.
- 3 Now press down movable handle to crimp the contact. After crimping is done, pull both bar away from each other to open the die.

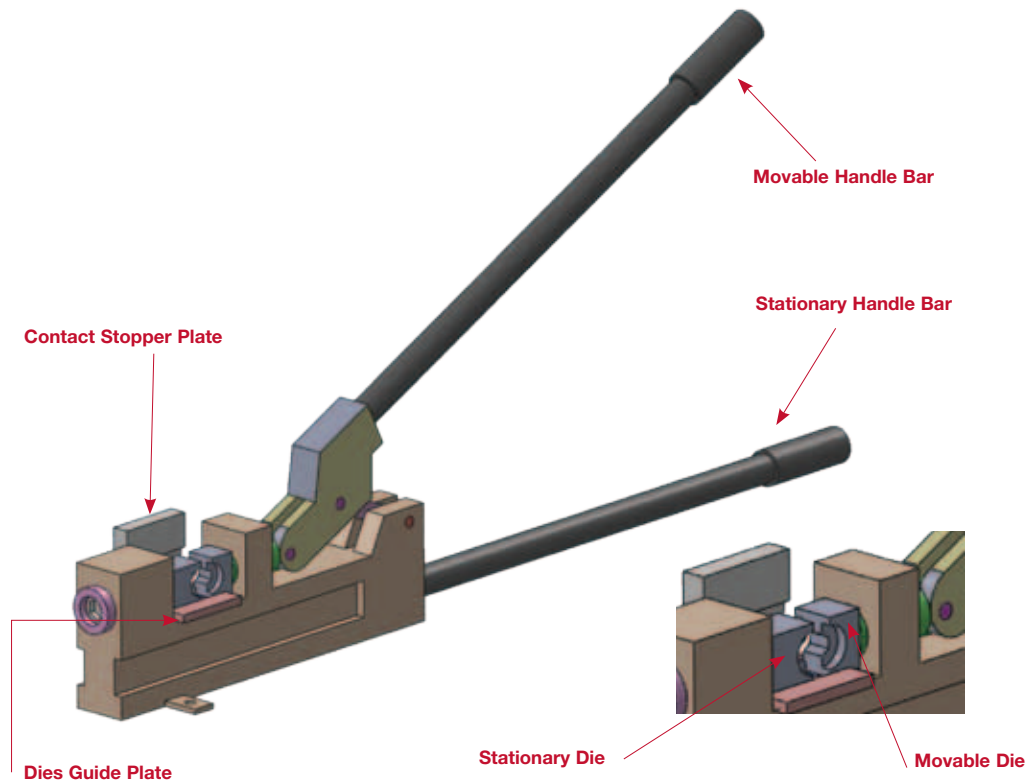

- 4 To remove pinched material of crimped contact, rotate the contact in 90 degrees and repeat step 2 and 3. Otherwise file off pinched material.



Final crimped contact shall look like this.

NOTE

Scorpion Low-Profile

configurable. low profile. connector. positronic.

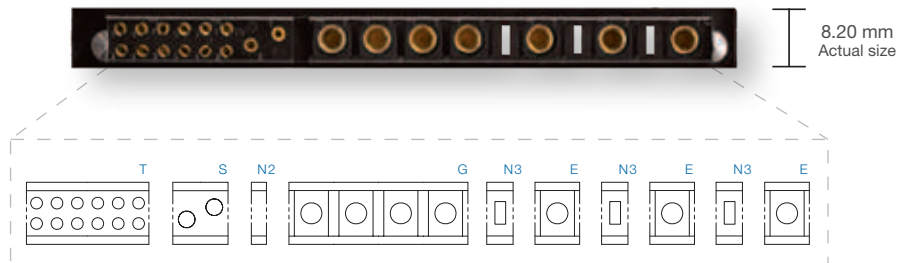

- Ideal for SWaP (size, weight & power) reduction
- Define the envelope and pin configuration
- One-piece low profile insulator
- Perfect for 1U applications
- Current ratings up to 55 amps per contact
- Power contact resistance is 0.7 milliohms maximum
- Nearly unlimited configurations
- Vent options for more effective air cooling
- Spacer options giving increase voltage capabilities
- Sequential mating contacts

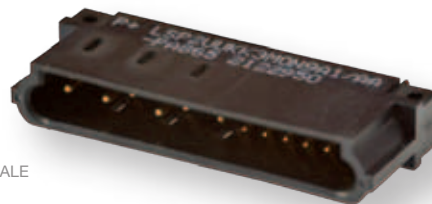
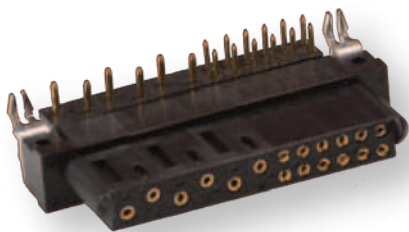
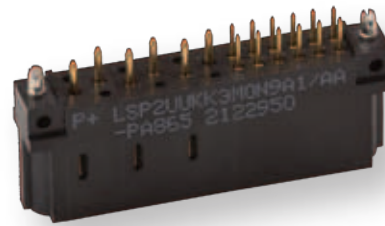

ALL IMAGES TO SCALE

Module Options

Size 12

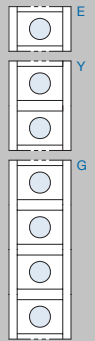

Size 20

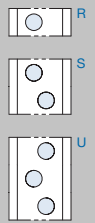

Size 22

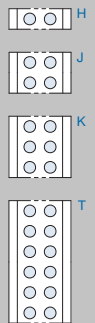

Spacers / Blanks



Today's hardware designs require maximum power output with minimal space and weight claim. Available in standard and low profile versions, Scorpion by Positronic is a configurable connector capable of virtually limitless pin layouts. This gives the designer the option to specify a connector perfectly suited to the application by achieving the ideal blend of size, weight and power (SWaP) – all of this without the high cost of NRE and long lead times.

Visit www.connectpositronic.com/scorpion for details.



Positronic[®]
global connector solutions



Cable Assembly Options

Positronic leverages its experience in high reliability connector manufacturing to build cable assemblies held to high standards. The cable assembly facility is certified to ISO9001 and AS9100. Contact Positronic for your optical cable needs.

Capabilities include:

- Design, development, engineering support and documentation
- Build-to-print
- Product prototyping and first articles
- Testing
- Adherence to IPC-620 standards

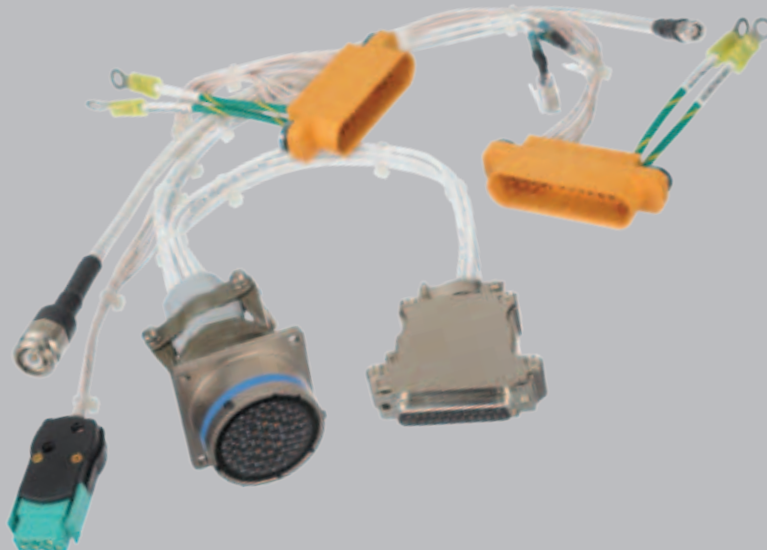

Regional Headquarters

Global Headquarters

Positronic | USA

423 N Campbell Ave
Springfield MO 65806 USA

+1 800 641 4054
info@connectpositronic.com

European Headquarters

Positronic | Europe

Z.I. d'Engachies
46, route d'Engachies
F-32020 Auch Cedex 9 France

+33 5 6263 4491
contact@connectpositronic.com

Asian Headquarters

Positronic | Asia

3014A Ubi Rd 1 #07-01
Singapore 408703

+65 6842 1419
singapore@connectpositronic.com

Sales Offices

Positronic has local sales representation all over the world. To find the nearest sales office, please visit www.connectpositronic.com/sales

