

### DESCRIPTION

The MP4078 is a single-stage offline controller with active power factor correction (PFC) for constant voltage output applications. The device implements primary-side regulation (PSR) control without requiring a secondary feedback circuit or optocoupler for flyback applications. It is also available for non-isolated topologies (e.g. buck-boost).

The device achieves ultra-low standby power consumption. Its pulse frequency modulation (PFM) implements a minimum operating frequency under no-load conditions. The MP4078 works in discontinuous conduction mode (DCM) with valley switching for improved efficiency performance.

The MP4078 operates in constant-on-time (COT) mode to achieve a high power factor across the universal input. It adopts a cascode MOSFET technique to achieve fast start-up with few external components.

The MP4078 integrates multiple protection features that greatly enhance system reliability and safety, including output over-voltage protection (OVP), output short-circuit protection (SCP), primary-side over-current protection (OCP), and over-temperature protection (OTP).

The MP4078 is available in an SOIC-8 package.

### FEATURES

- Primary-Side Control with Simple Design and Minimal External Components
- Ultra-Low No-Load Power Consumption, Typically below 50mW with 230V<sub>AC</sub>
- Good Performance on PF and THD
- Fast Transient Response
- Fast Start-Up
- Novel Control Scheme with Continuous Peak Current Limitation
- Primary-Side Over-Current Protection (OCP)
- Output Over-Voltage Protection (OVP)
- Output Short-Circuit Protection (SCP)
- Brownout Protection
- Thermal Shutdown
- Available in an SOIC-8 Package

### APPLICATIONS

- Smart LED Lighting
- Front-End Pre-Regulators

All MPS parts are lead-free, halogen-free, and adhere to the RoHS directive. For MPS green status, please visit the MPS website under Quality Assurance. "MPS", the MPS logo, and "Simple, Easy Solutions" are trademarks of Monolithic Power Systems, Inc. or its subsidiaries.

### TYPICAL APPLICATION CIRCUIT

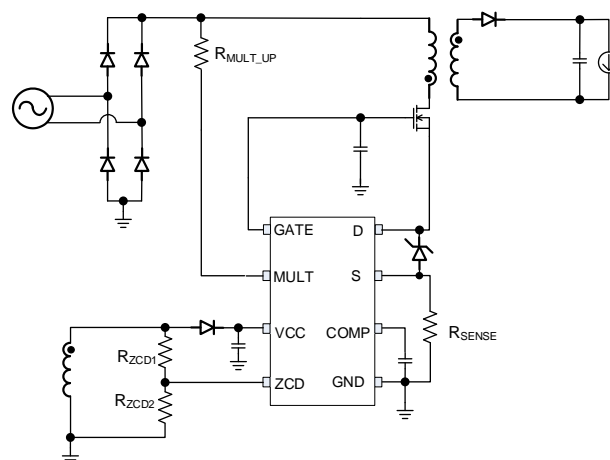

Figure 1: Isolated Flyback Application

### ORDERING INFORMATION

Part Number*	Package	Top Marking	MSL Rating
MP4078GS	SOIC-8	See Below	2

\* For Tape & Reel, add suffix -Z (e.g. MP4078GS-Z).

### TOP MARKING

\_\_\_\_\_  
**MP4078**  
**LLLLLLLLL**  
**MPSYWW**

MP4078: Part number  
 LLLLLLLL: Lot number  
 MPS: MPS prefix  
 Y: Year code  
 WW: Week code

### PACKAGE REFERENCE

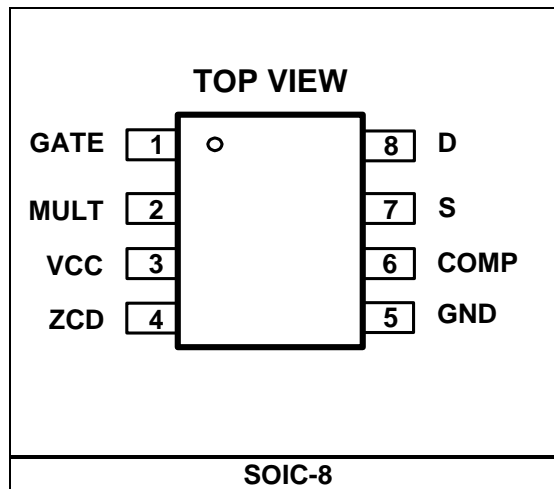

## PIN FUNCTIONS

Pin #	Name	Description
1	GATE	<b>Gate driver output for external MOSFET.</b> The GATE pin is only used in the cascode architecture. For a stable voltage, connect a ceramic capacitor (e.g. 0.47 $\mu$ F) from this pin to ground.
2	MULT	<b>Rectified input sensing with multiple functions.</b> Connect MULT to the rectified input with pull-up resistors. The MULT pin can change GATE before the MP4078 turns on. Once the device turns on, this pin is pulled down internally and forms a resistor divider to detect the peak rectified input voltage.
3	VCC	<b>Power supply input.</b> Place a bypass capacitor between VCC and GND, as close to the device as possible.
4	ZCD	<b>Zero-current detection with multiple functions.</b> The ZCD pin provides output voltage sensing for primary regulation. It is also used for zero-current detection, and can be configured to set the maximum operating frequency.
5	GND	<b>Ground.</b> The current returns for both the control signal and the gate drive signal.
6	COMP	<b>Loop compensation.</b> The COMP pin provides loop compensation and the output of the feedback error amplifier. Connect a compensation network between COMP and GND.
7	S	<b>Source of internal low-side main MOSFET.</b> Place a resistor between S and GND to sense the peak primary current.
8	D	<b>Drain of internal low-side main MOSFET.</b> Connect D to the source of the external cascode MOSFET.

### ABSOLUTE MAXIMUM RATINGS <sup>(1)</sup>

Supply voltage ( $V_{CC}$ ).....	-0.3V to +28V
GATE.....	-0.3V to +28V
GATE max sink current.....	5mA
MULT.....	-0.3V to +28V
MULT max sink current.....	2mA
ZCD.....	-0.7V to +6.5V
ZCD max source current.....	-1mA
Low-side MOSFET drain-to-source voltage .....	-0.7V to +35V
All other pins .....	-0.3V to +6.5V
Continuous power dissipation ( $T_A = 25^\circ\text{C}$ ) <sup>(2)</sup>	
SOIC-8.....	1.3W
Junction temperature .....	150°C
Lead temperature .....	260°C
Storage temperature.....	-65°C to +150°C

### ESD Ratings

Human body model (HBM) .....	$\pm 1800\text{V}$
Charged device model (CDM).....	$\pm 2000\text{V}$

### Recommended Operating Conditions <sup>(3)</sup>

Supply voltage ( $V_{CC}$ ) ..	8.4V to 25V
Operating junction temp ( $T_J$ ) ....	-40°C to +125°C

<i>Thermal Resistance</i> <sup>(4)</sup>	$\theta_{JA}$	$\theta_{JC}$
SOIC-8.....	96.....	45.....°C/W

#### Notes:

- Exceeding these ratings may damage the device.
- The maximum allowable power dissipation is a function of the maximum junction temperature,  $T_J$  (MAX), the junction-to-ambient thermal resistance,  $\theta_{JA}$ , and the ambient temperature,  $T_A$ . The maximum allowable continuous power dissipation at any ambient temperature is calculated by  $P_D$  (MAX) =  $(T_J$  (MAX) -  $T_A$ ) /  $\theta_{JA}$ . Exceeding the maximum allowable power dissipation will cause excessive die temperature, and the regulator will go into thermal shutdown. Internal thermal shutdown circuitry protects the device from permanent damage.
- The device is not guaranteed to function outside of its operating conditions.
- Measured on JESD51-7, 4-layer PCB.

## ELECTRICAL CHARACTERISTICS

$V_{CC} = 12V$ ,  $T_J = -40^{\circ}C$  to  $+125^{\circ}C$ , min and max are guaranteed by characterization, typically tested under  $25^{\circ}C$ , unless otherwise specified.

Parameter	Symbol	Condition	Min	Typ	Max	Units
<b>Supply Voltage</b>						
Operating range	$V_{CC}$	After turn-on	8.4		25	V
$V_{CC}$ upper level: internal charging circuit stops and the IC turns on	$V_{CCH}$	$V_{CC}$ rising	9.9	10.5	11.1	V
$V_{CC}$ lower level: internal charging circuit starts	$V_{CCL}$	$V_{CC}$ falling	7.4	7.9	8.4	V
$V_{CC}$ hysteresis	$V_{CC\_HYS}$		2.2	2.6	2.9	V
<b>Supply Current</b>						
Operating current	$I_{CC}$	$V_{COMP} = 0.3V$		180	300	$\mu A$
		$V_{COMP} = 3V$		300	400	$\mu A$
$V_{CC}$ charging current from the D pin	$I_{D\_CHARGE}$	$V_D = 16V$ , $V_{CC} = 9.8V$	3	5	7.4	mA
Operating current under a fault condition	$I_{FAULT}$	IC latch off, $V_{CC} = 15V$	200	360	500	$\mu A$
<b>GATE</b>						
GATE clamp voltage	$V_{GATE\_CLAMP}$	$I_{GATE} = 2mA$	17	18.2	19.4	V
<b>MULT</b>						
MULT leakage current	$I_{MULT\_LEAKAGE}$	$V_{MULT} = 15V$		10	500	nA
MULT pull-down resistor	$R_{MULT}$		28.5	30	32.5	k $\Omega$
MULT detection time delay	$t_{MULT\_DELAY}$			11	19.8	ms
Brown-in threshold	$V_{MULT\_BI}$		280	320	350	mV
Brownout threshold	$V_{MULT\_BO}$		180	210	240	mV
Brownout hysteresis	$V_{MULT\_BO\_HYS}$		86	110	130	mV
Brownout detection time	$t_{MULT\_BO}$		19	24	36	ms
<b>Error Amplifier</b>						
Transconductance <sup>(5)</sup>	$G_{EA}$			100		$\mu A/V$
COMP higher clamp voltage	$V_{COMP\_H}$		4.07	4.25	4.39	V
COMP lower clamp voltage	$V_{COMP\_L}$			0	50	mV
Maximum source current	$I_{COMP+}$			730	1200	$\mu A$
Maximum sink current	$I_{COMP-}$			900	1350	$\mu A$
COMP voltage vs. $V_{CS\_MAX}$	$V_{COMP\_FULL}$		2.7	2.85	3.01	V
COMP voltage vs. $V_{CS\_MIN}$	$V_{COMP\_MIN}$		0.8	0.9	1	V
COMP voltage vs. on-time increasing <sup>(6)</sup>	$V_{COMP\_HALF}$			2.2		V

**ELECTRICAL CHARACTERISTICS (continued)**

$V_{CC} = 12V$ ,  $T_J = -40^{\circ}C$  to  $+125^{\circ}C$ , min and max are guaranteed by characterization, typically tested under  $25^{\circ}C$ , unless otherwise specified.

Parameter	Symbol	Condition	Min	Typ	Max	Units
<b>Current Sense Comparator</b>						
Leading-edge blanking time	$t_{LEB}$		460	620	810	ns
Leading-edge blanking time for OCP	$t_{LEB\_OCP}$		340	430	660	ns
OCP threshold	$V_{CS\_OCP}$		1.9	2	2.1	V
Maximum current limit	$V_{CS\_MAX}$		0.72	0.88	0.98	V
Minimum current limit	$V_{CS\_MIN}$		0.1	0.17	0.21	V
<b>Zero-Current Detection (ZCD) and Feedback</b>						
ZCD threshold voltage	$V_{ZCD\_TH}$	$V_{ZCD}$ falling	79	100	112	mV
ZCD hysteresis	$V_{ZCD\_HYS}$		88	105	124	mV
ZCD sensing delay time	$t_{ZCD\_DELAY}$	After shutdown, $V_{CS} > 0.3V$	1.3	1.79	2.5	$\mu s$
		After shutdown, $V_{CS} \leq 0.3V$	0.9	1.16	1.75	$\mu s$
ZCD turn-on delay time <sup>(6)</sup>	$t_{ZCD\_ON}$	After ZCD falling detected		300		ns
Minimum off time <sup>(6)</sup>	$t_{OFF\_MIN}$			6.5		$\mu s$
Maximum working cycle <sup>(6)</sup>	$t_{CYCLE\_MAX}$			6		ms
Minimum working cycle	$t_{CYCLE\_MIN}$	$R_{ZCD1} // R_{ZCD2} > 8.8k\Omega$	9.6	11	12.7	$\mu s$
		$2.8k\Omega < R_{ZCD1} // R_{ZCD2} < 3.3k\Omega$	14	15.3	17.5	
Reference voltage	$V_{REF}$		2.41	2.49	2.55	V
FB transient low trigger threshold	$V_{FB\_LOW}$		1.93	2.08	2.23	V
FB transient low recovery threshold	$V_{FB\_LOW\_REC}$		2.12	2.23	2.44	V
FB transient low hysteresis <sup>(6)</sup>	$V_{FB\_LOW\_HYS}$	Greater than $V_{FB\_LOW}$		0.15		V
FB transient high trigger threshold	$V_{FB\_HIGH}$		2.67	2.87	3.06	V
FB transient high recovery threshold	$V_{FB\_HIGH\_REC}$		2.5	2.67	2.86	V
FB transient high hysteresis <sup>(6)</sup>	$V_{FB\_HIGH\_HYS}$	Lower than $V_{FB\_HIGH}$		0.2		V
FB start-up finish threshold <sup>(5)</sup>	$V_{FB\_NORMAL}$			2.4		V
FB start-up finish hysteresis <sup>(5)</sup>	$V_{FB\_NORMAL\_HYS}$			0.15		V
Over-voltage protection threshold	$V_{FB\_OVP}$		2.84	2.96	3.1	V
Short-circuit protection threshold	$V_{FB\_SCP}$		165	200	235	mV
Short-circuit protection duration	$t_{SCP}$			2.3	6	ms
Short-circuit protection duration for start-up <sup>(5)</sup>	$t_{SCP\_STARTUP}$			100		ms
<b>Starter</b>						
Start timer period	$t_{START}$		40	49	70	$\mu s$

**ELECTRICAL CHARACTERISTICS (continued)**

$V_{CC} = 12V$ ,  $T_J = -40^{\circ}C$  to  $+125^{\circ}C$ , min and max are guaranteed by characterization, typically tested under  $25^{\circ}C$ , unless otherwise specified.

Parameter	Symbol	Condition	Min	Typ	Max	Units
<b>Internal Main MOSFET</b>						
Breakdown voltage	$BV_{DSS\_MAIN}$	$V_{GS} = 0V$	35			V
Drain-source on resistor	$R_{DS(ON)\_MAIN}$	$I_{DS} = 100mA$ , $T_A = 25^{\circ}C$		265	320	mΩ
		$I_{DS} = 100mA$ , $T_A = 125^{\circ}C$		370	430	
		$I_{DS} = 100mA$ , $T_A = 25^{\circ}C$ , $V_{CC} = V_{CCH} + 50mV$		270	330	
		$I_{DS} = 100mA$ , $T_A = 125^{\circ}C$ , $V_{CC} = V_{CCH} + 50mV$		380	440	
Leakage current on the D pin	$I_{LEAKAGE\_D}$				1	μA
<b>Internal OVP Pull-Up MOSFET</b>						
Breakdown voltage	$BV_{DSS\_D\_VCC}$	$V_{GS} = 0V$	28			V
Drain-source on resistor	$R_{DS(ON)\_D\_VCC}$	$I_{DS} = 50mA$ , $T_A = 25^{\circ}C$		225	300	Ω
<b>Thermal Shutdown</b>						
Thermal shutdown threshold <sup>(5)</sup>	$T_{TSD}$			160		°C
Thermal shutdown hysteresis <sup>(5)</sup>	$T_{TSD\_HYS}$			60		°C

**Notes:**

- 5) Guaranteed by design.
- 6) Guaranteed by characterization.

## TYPICAL CHARACTERISTICS

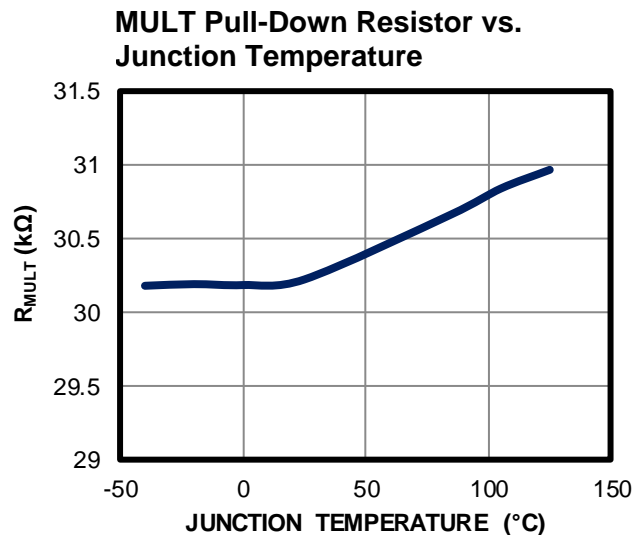
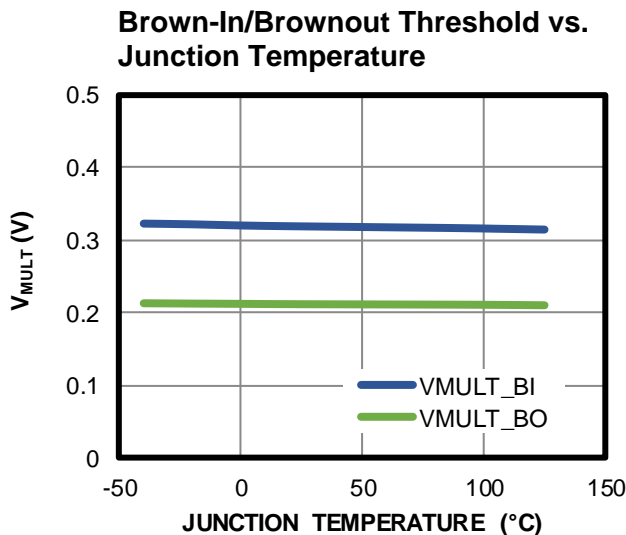
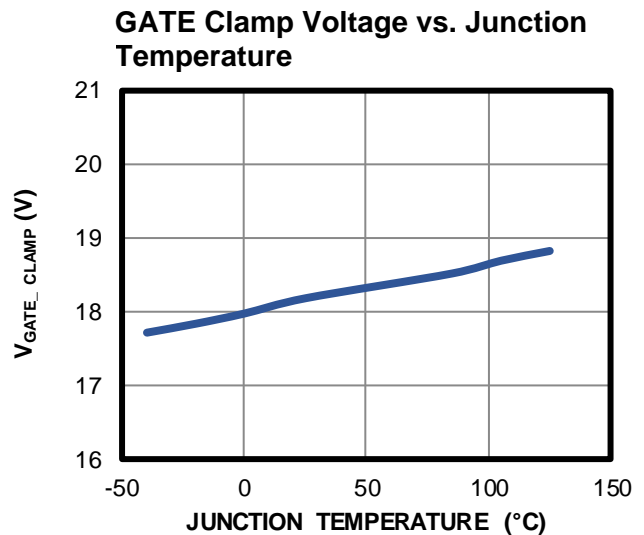
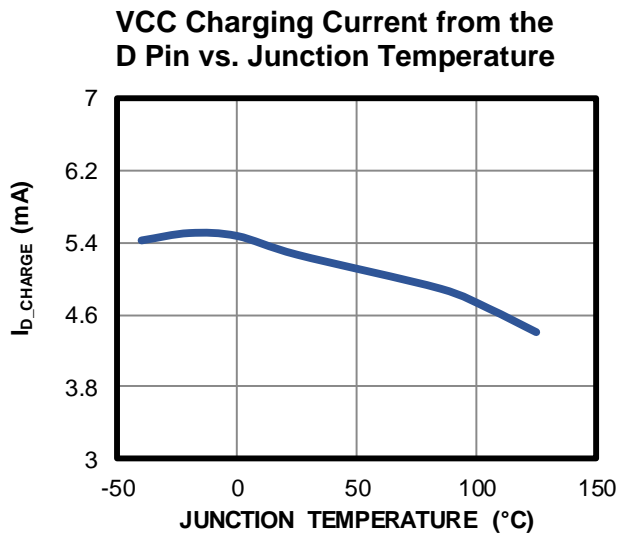
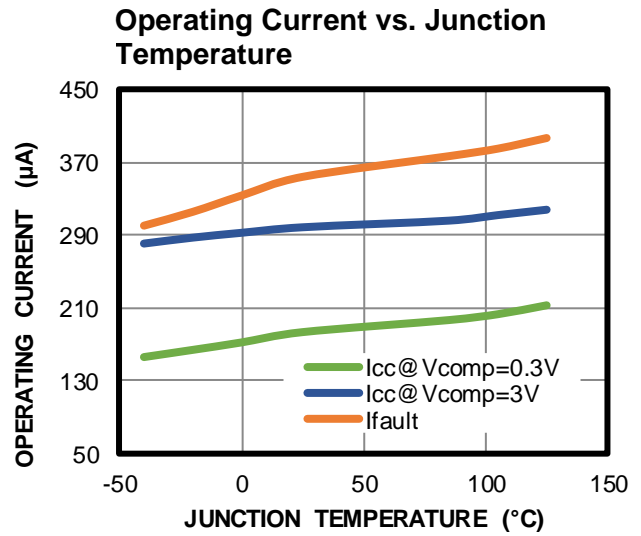
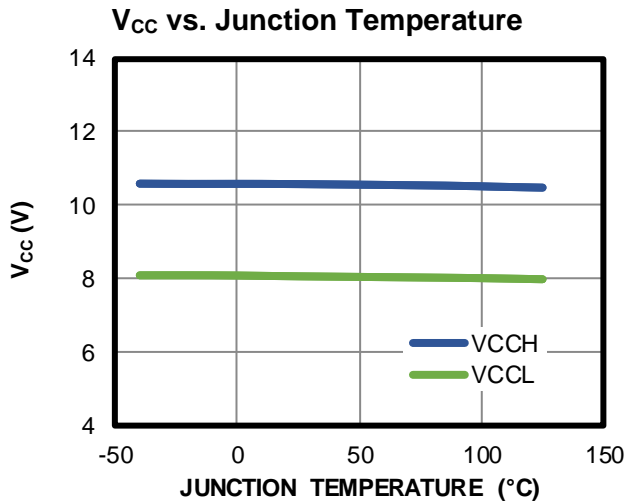

## TYPICAL CHARACTERISTICS (continued)

COMP Voltage vs. Junction Temperature

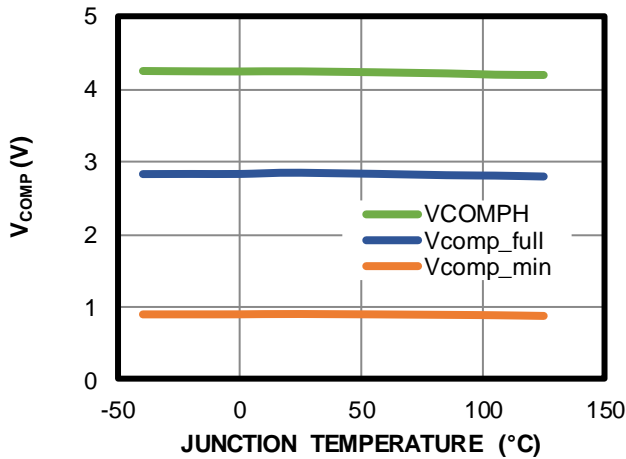

Leading-Edge Blanking Time vs. Junction Temperature

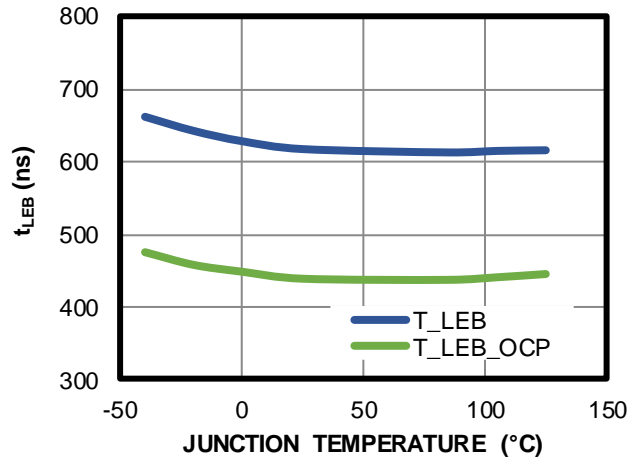

OCP Threshold vs. Junction Temperature

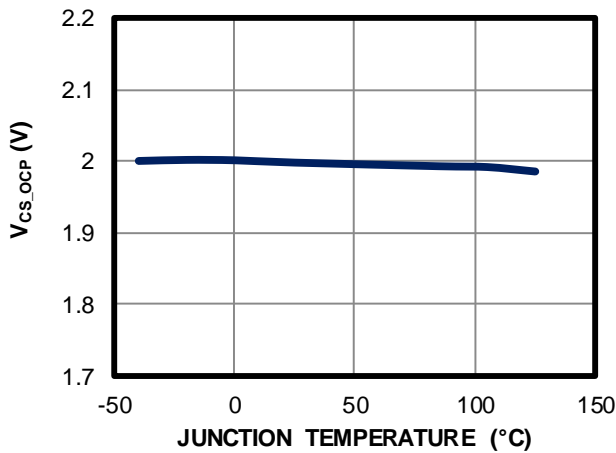

Current Limit Threshold vs. Junction Temperature

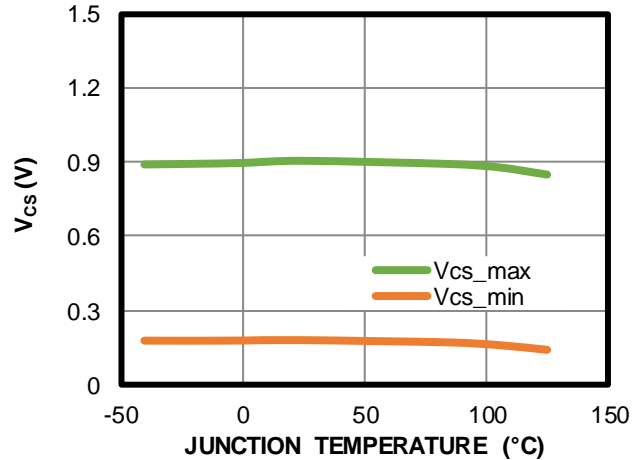

ZCD Threshold vs. Junction Temperature

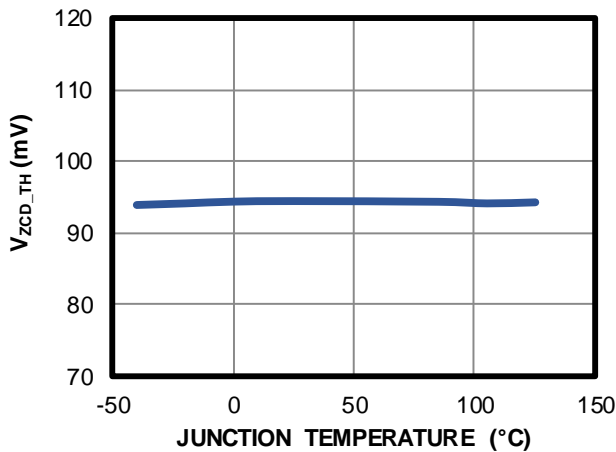

ZCD Sensing Delay Time vs. Junction Temperature

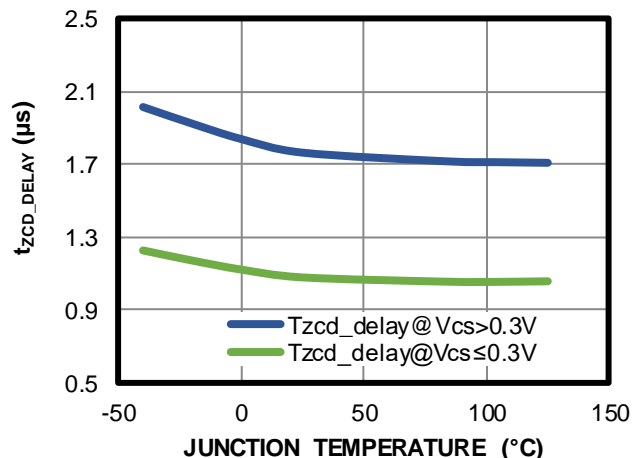

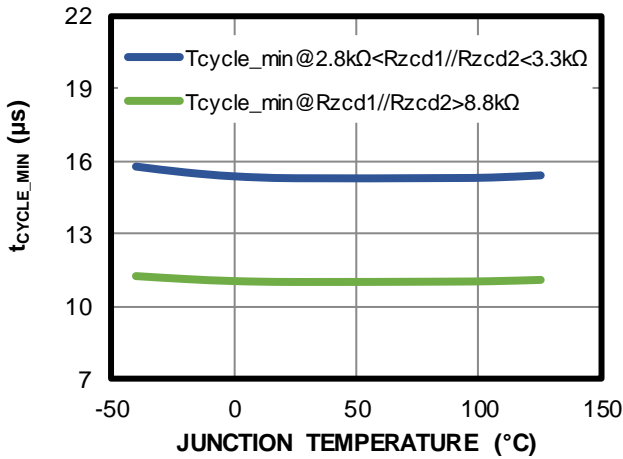
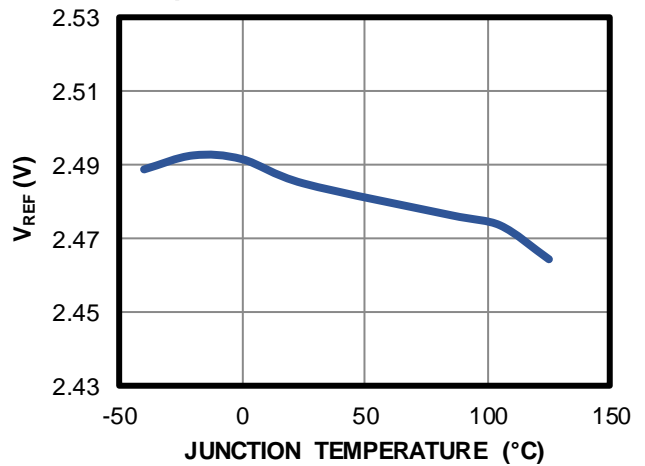
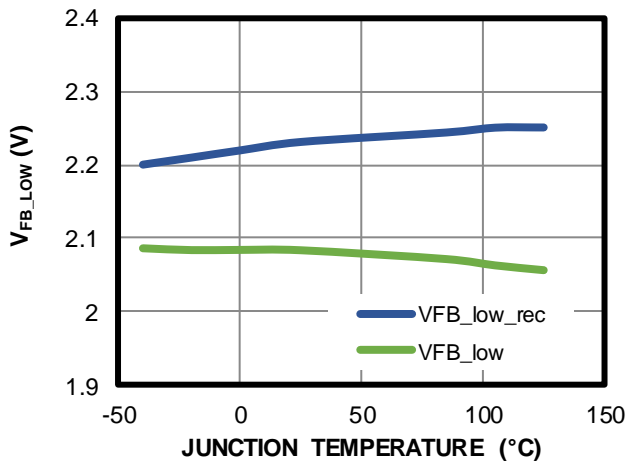
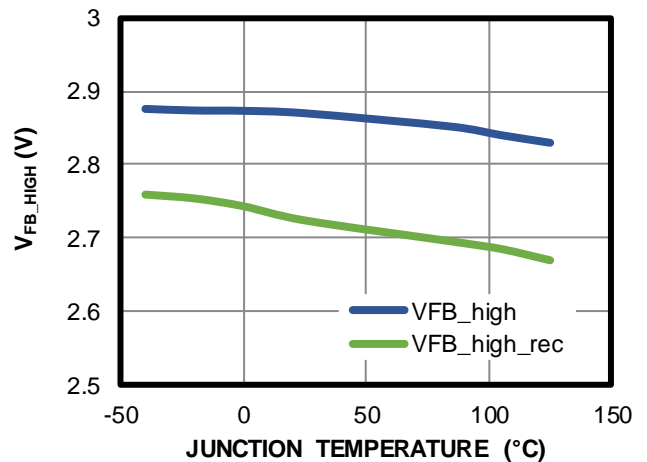
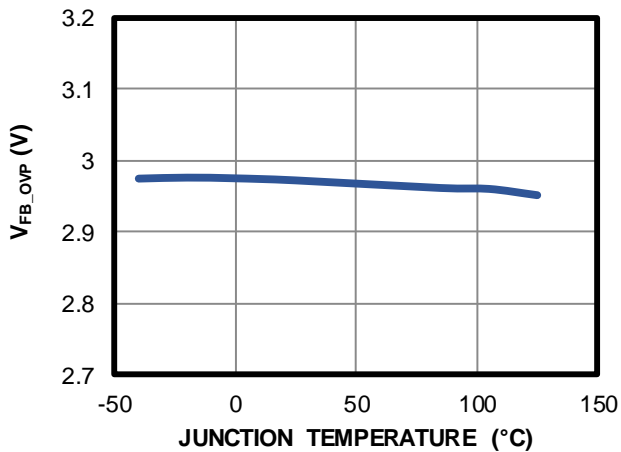
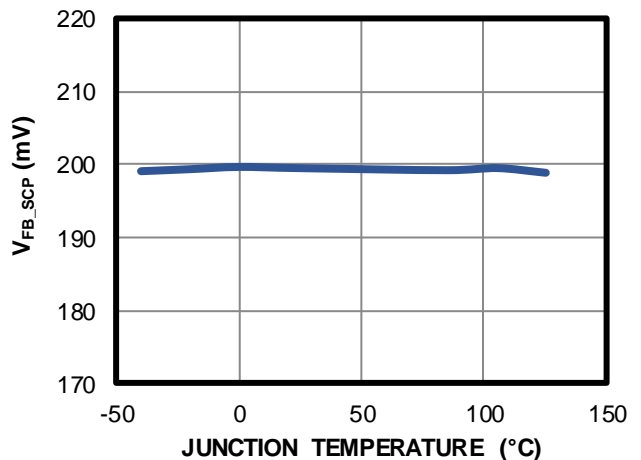

**TYPICAL CHARACTERISTICS (continued)**
**Minimum Working Cycle vs. Junction Temperature**

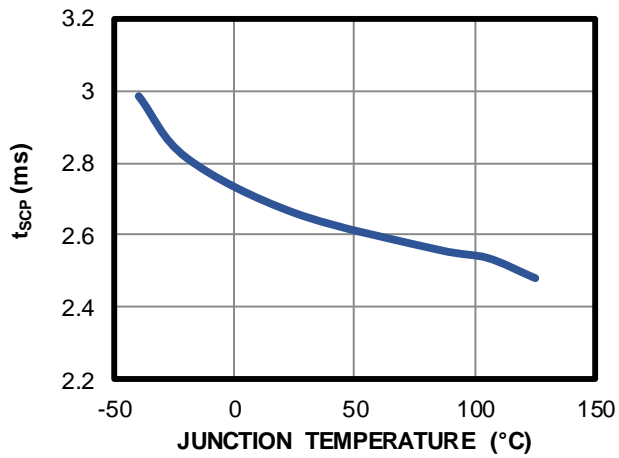
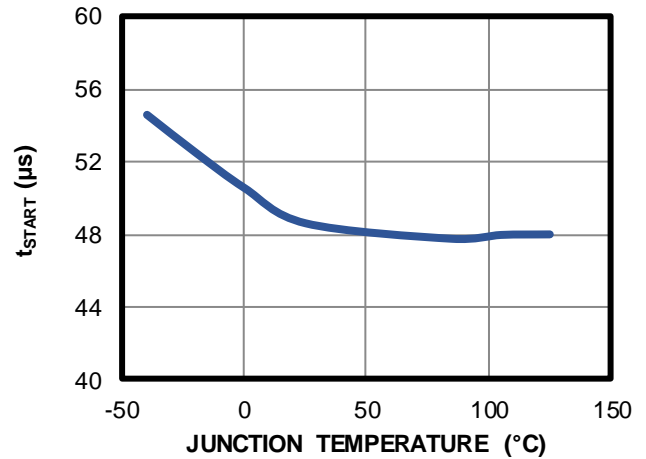
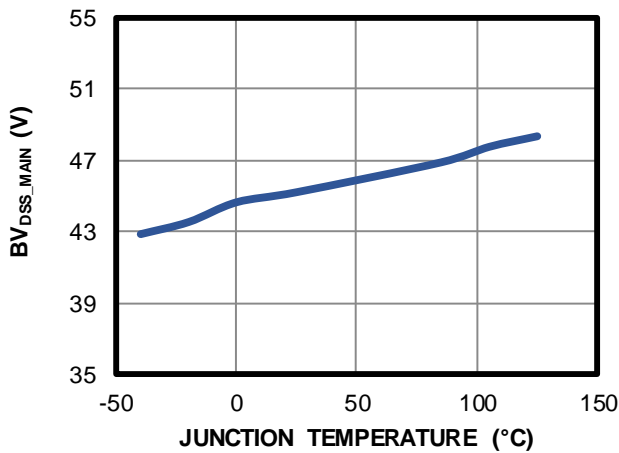
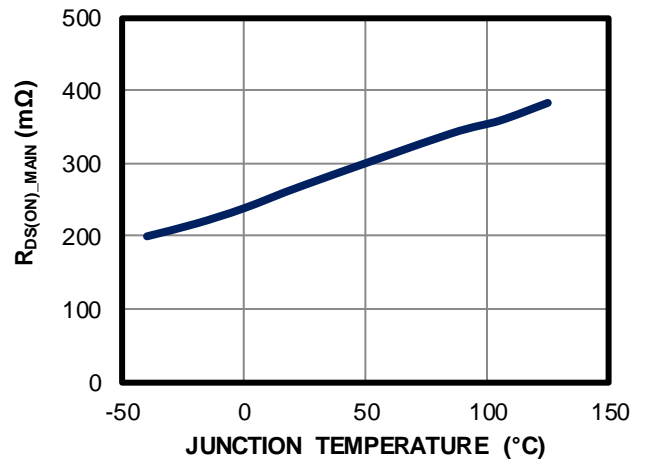
**Reference Voltage vs. Junction Temperature**

**FB Transient Low Threshold vs. Junction Temperature**

**FB Transient High Threshold vs. Junction Temperature**

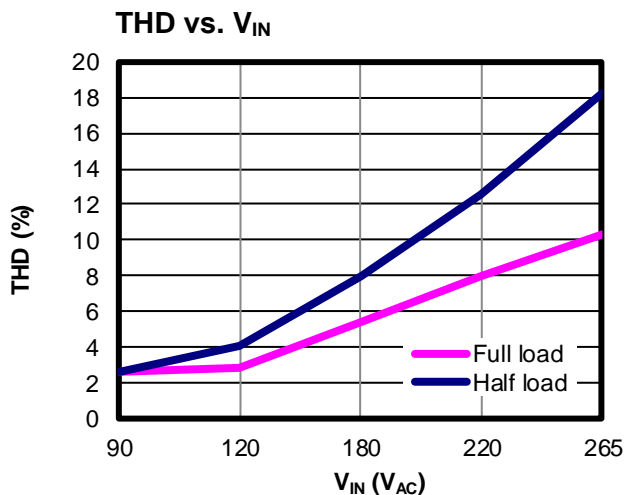
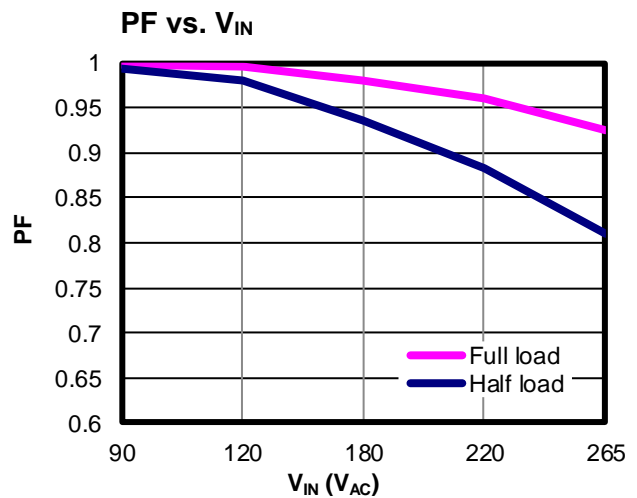
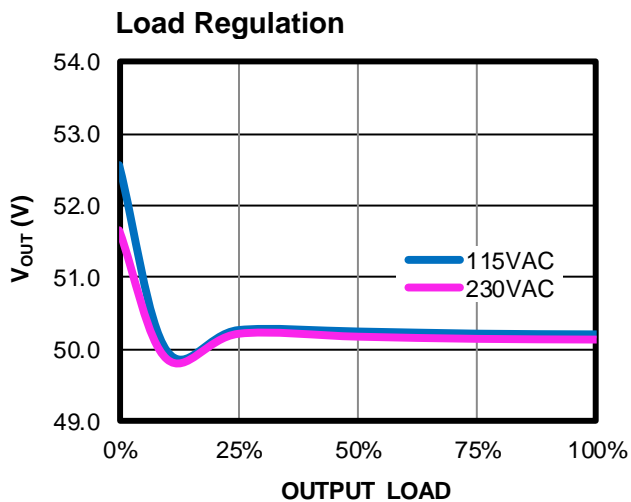
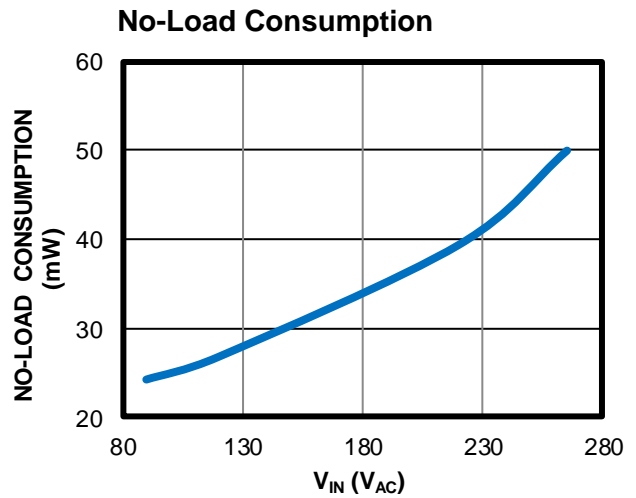
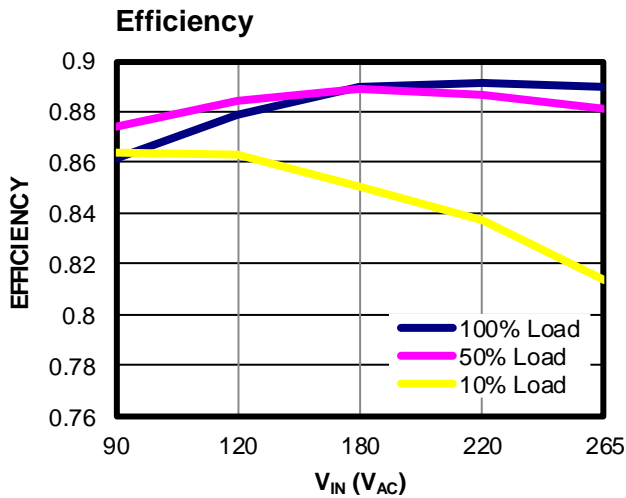
**OVP Threshold vs. Junction Temperature**

**SCP Threshold vs. Junction Temperature**

**TYPICAL CHARACTERISTICS (continued)**
**SCP Duration vs. Junction Temperature**

**Start Timer Period vs. Junction Temperature**

**Internal Main MOSFET Breakdown Voltage vs. Junction Temperature**

**Internal Main MOSFET On Resistor vs. Junction Temperature**

## TYPICAL PERFORMANCE CHARACTERISTICS

Performance waveforms are tested on the EV4078-S-00A evaluation board,  $V_{IN} = 90V_{AC}$  to  $265V_{AC}$ ,  $V_{OUT} = 50V$ ,  $I_{OUT} = 600mA$ ,  $T_A = 25^{\circ}C$ , unless otherwise noted.



**TYPICAL PERFORMANCE CHARACTERISTICS** *(continued)*

Performance waveforms are tested on the EV4078-S-00A evaluation board,  $V_{IN} = 90V_{AC}$  to  $265V_{AC}$ ,  $V_{OUT} = 50V$ ,  $I_{OUT} = 600mA$ ,  $T_A = 25^{\circ}C$ , unless otherwise noted.

**Input Voltage and Current**

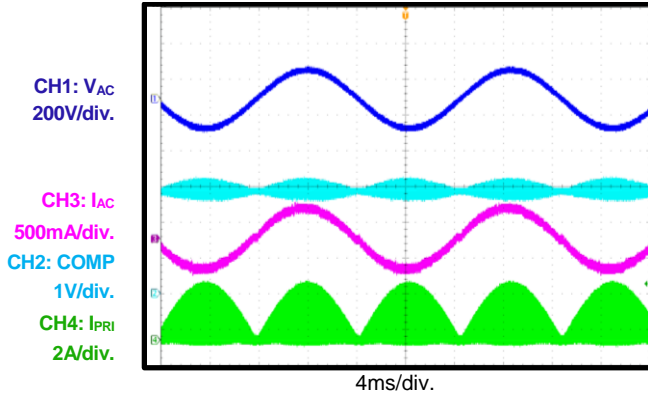
 115V<sub>AC</sub>, full load

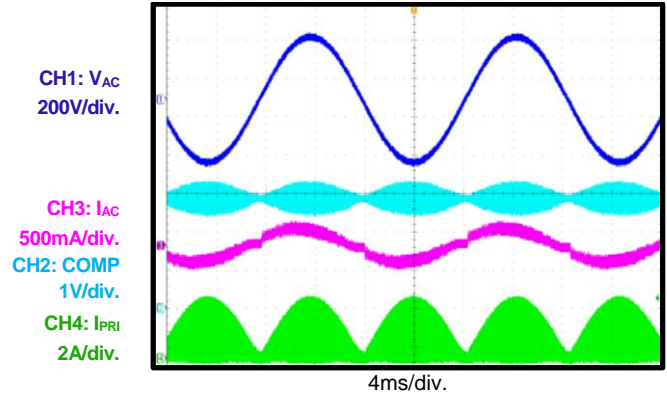
**Input Voltage and Current**

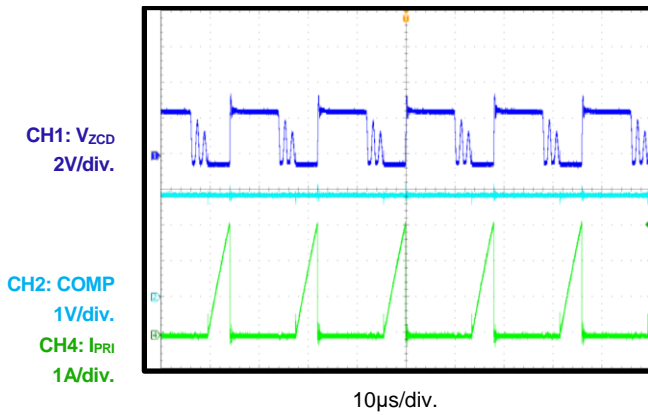
 230V<sub>AC</sub>, dull load

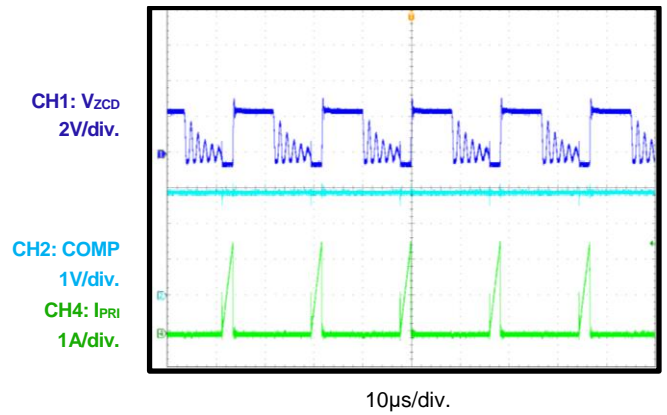
**Steady State**

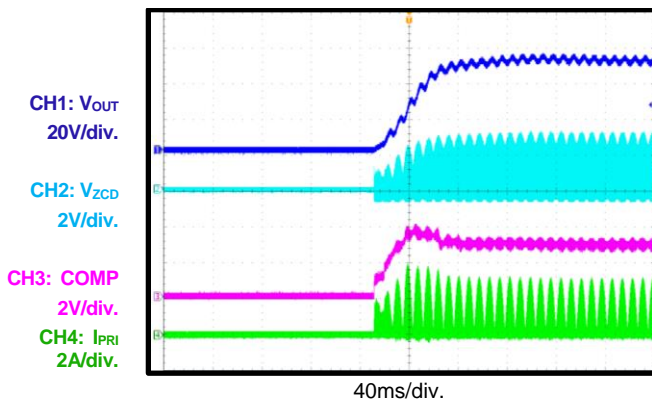
 115V<sub>AC</sub>, full load

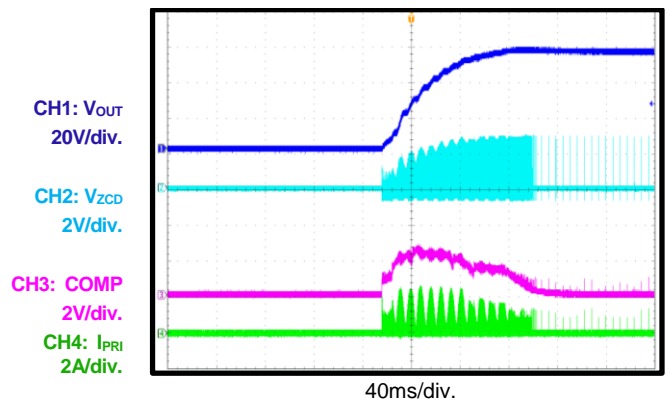
**Steady State**

 230V<sub>AC</sub>, full load

**Start-Up**

 230V<sub>AC</sub>, full load

**Start-Up**

 230V<sub>AC</sub>, no load

## TYPICAL PERFORMANCE CHARACTERISTICS *(continued)*

Performance waveforms are tested on the EV4078-S-00A evaluation board,  $V_{IN} = 90V_{AC}$  to  $265V_{AC}$ ,  $V_{OUT} = 50V$ ,  $I_{OUT} = 600mA$ ,  $T_A = 25^{\circ}C$ , unless otherwise noted.

### Shutdown

230V<sub>AC</sub>, full load

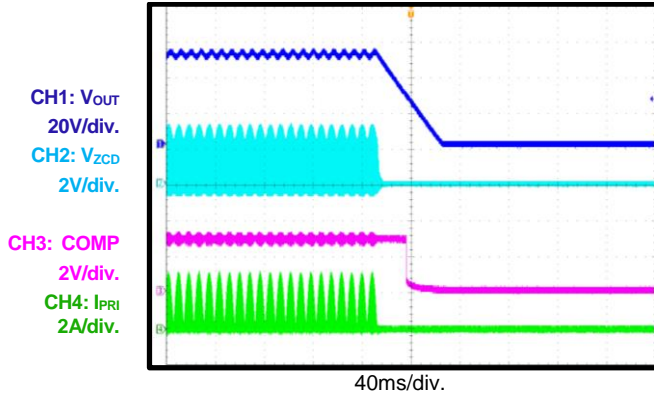

### Transient High Triggering

230V<sub>AC</sub>, full load to no load

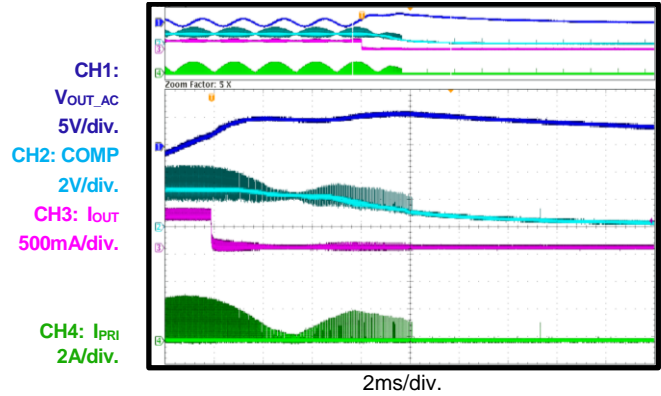

### Transient High Triggering

230V<sub>AC</sub>, full load to no load

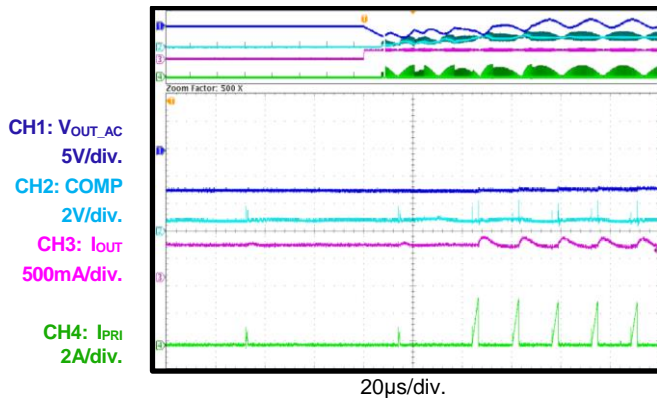

### SCP

230V, full load

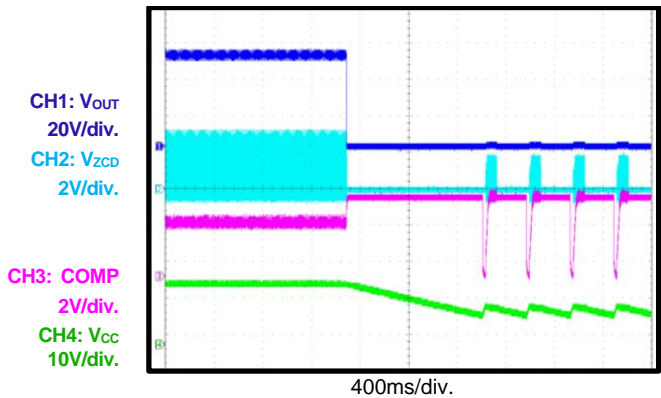

### Short then Start

230V, full load

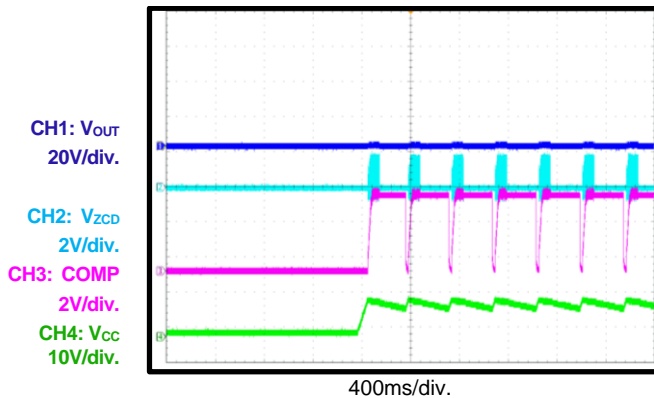

## FUNCTIONAL BLOCK DIAGRAM

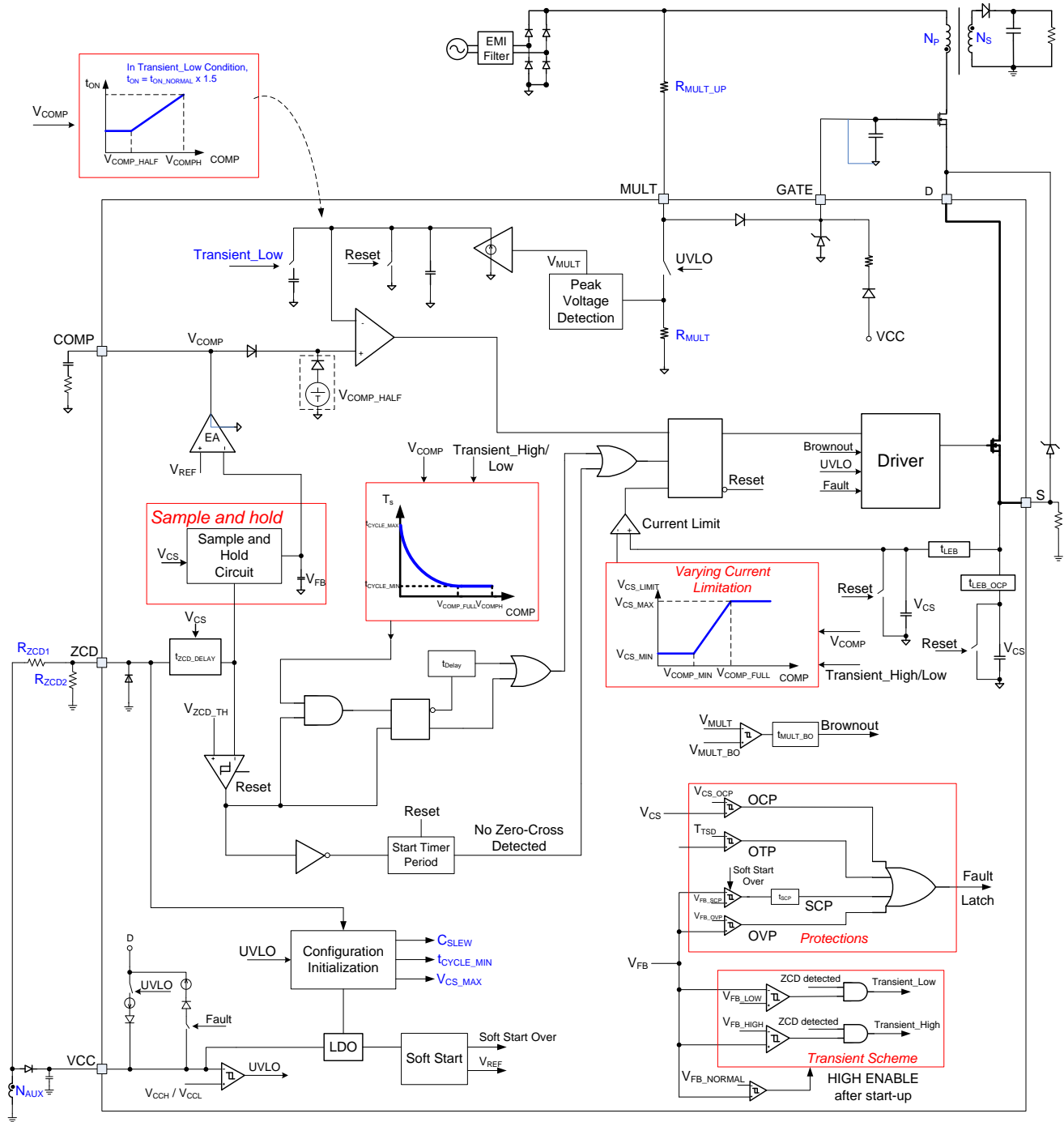

Figure 2: MP4078 Functional Block Diagram

## OPERATION

The MP4078 is a primary-side regulation (PSR) controller with power factor correction (PFC) for applications with offline, constant-voltage LED drivers or pre-regulators. The MP4078 achieves good performance with high power factor (PF), low total harmonic distortion (THD), fast transient response, and ultra-low standby power consumption. It also eliminates the cost of the optocoupler and secondary regulation circuits required in conventional flyback design applications.

### Start-Up

Initially, the voltage on the GATE pin ( $V_{GATE}$ ) is charged through the external pull-up resistor ( $R_{MULT\_UP}$ ), which is placed between the MULT pin and the rectified input voltage. When  $V_{GATE}$  reaches the gate threshold of the external MOSFET, the MP4078 uses cascode MOSFET architecture to charge the voltage on the VCC pin ( $V_{CC}$ ) through a built-in current source. When  $V_{CC}$  reaches the IC turn-on threshold ( $V_{CCH}$ ), the MP4078 initializes the configuration of the minimum working cycle ( $t_{CYCLE\_MIN}$ ) and the coefficient of the on-time generator ( $K_{SLEW}$ ) (see Table 1).

**Table 1: Configuration Options**

	Condition	Condition
$R_{ZCD1} // R_{ZCD2}$	2.8k $\Omega$ to 3.3k $\Omega$	Minimum 8.8k $\Omega$
$t_{CYCLE\_MIN}$	15.3 $\mu$ s	11 $\mu$ s
$K_{SLEW}$	$9 \times 10^{-7}$ s	$4.5 \times 10^{-7}$ s
<b>Application Input Range</b> (7)	Universal input (85V <sub>AC</sub> to 277V <sub>AC</sub> )	220V <sub>AC</sub> / 230V <sub>AC</sub> $\pm$ 20%

**Note:**

7) Recommended in design.

After  $V_{CC}$  reaches  $V_{CCH}$ , the MP4078 also stops charging  $V_{CC}$  internally and pulls down the MULT pin through an internal pull-down resistor ( $R_{MULT}$ ).  $R_{MULT}$  and  $R_{MULT\_UP}$  form a resistor divider to sense the input voltage. Once the peak voltage on the MULT pin ( $V_{MULT}$ ) exceeds the brown-in threshold ( $V_{MULT\_BI}$ ), the MP4078 begins to switch with a soft start.

### Primary-Side Regulation

Figure 3 shows a simplified flyback converter circuit.

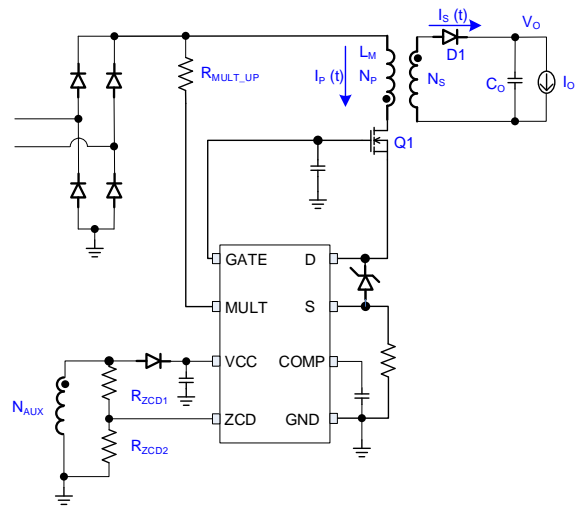

**Figure 3: Flyback Converter**

Figure 4 illustrates the key waveforms of the flyback converter.

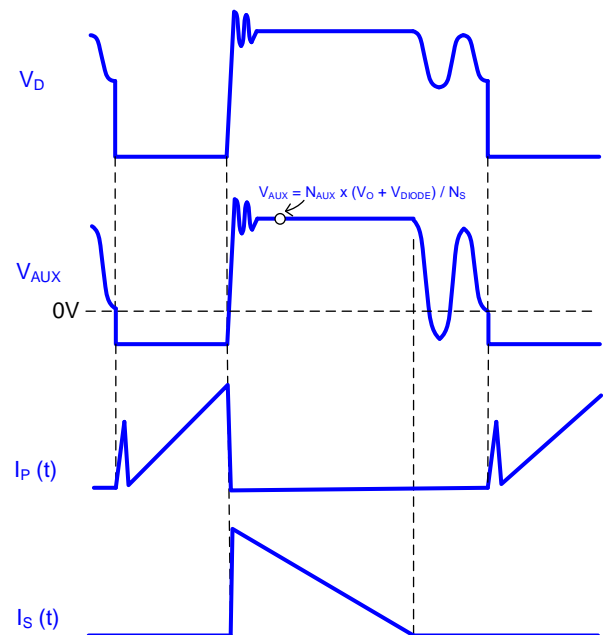

**Figure 4: Key Waveforms of Flyback Converters**

While the external MOSFET (Q1) turns on, the rectified input voltage applied on the primary inductor ( $L_M$ ) makes the primary current increase linearly. The rectified diode (D1) is reversely biased, and the load current ( $I_o$ ) is supplied by the secondary capacitor ( $C_o$ ). Then Q1 turns off, D1 conducts, and the stored energy in the transformer is delivered to the output.



To regulate the output, all information regarding the output voltage must be accurately sensed.

The plateau voltage of the auxiliary winding is proportional to the output voltage while D1 conducts, so this value can be used to indicate the output voltage. The MP4078 monitors this signal on the ZCD pin through a resistor divider.

Because the auxiliary winding voltage is not stable or constant, it requires a sample hold circuit to generate a feedback voltage ( $V_{FB}$ ) that is equal to the sensed plateau voltage.  $V_{FB}$  represents the output voltage, and is regulated by the internal reference ( $V_{REF}$ ). Calculate the ZCD resistor divider ratio with Equation (1):

$$V_{REF} \times \frac{R_{ZCD1} + R_{ZCD2}}{R_{ZCD2}} = (V_O + V_{DIODE}) \times \frac{N_{AUX}}{N_S} \quad (1)$$

Where  $R_{ZCD1}$  and  $R_{ZCD2}$  are external resistor dividers around the ZCD pin,  $V_O$  is the output voltage,  $V_{DIODE}$  is the forward voltage drop of the rectified diode (D1),  $N_{AUX}$  is the number of turns on the auxiliary winding for VCC, and  $N_S$  is the number of turns on the secondary winding for the output.

Because of the parasitic capacitance and inductance in circuits, switching spikes inevitably exist on the windings when Q1 turns off. This affects the sensing accuracy on the ZCD pin without any blanking time delay. It also inaccurately senses the plateau voltage with a long blanking time delay, since the D1 current drops to zero (especially under light-load conditions).

The MP4078 has an internal variable delay time for ZCD sensing ( $t_{ZCD\_DELAY}$ ). Its value depends on the peak voltage ( $V_{CS}$ ) on the S pin (the source of the internal MOSFET), which represents the load condition. Under heavy-load conditions ( $V_{CS} > 0.3V$ ),  $t_{ZCD\_DELAY}$  is set to about  $1.79\mu s$ . Under light-load conditions ( $V_{CS} \leq 0.3V$ ),  $t_{ZCD\_DELAY}$  is adjusted to about  $1.16\mu s$ .

Figure 5 shows the ZCD sensing delay time.

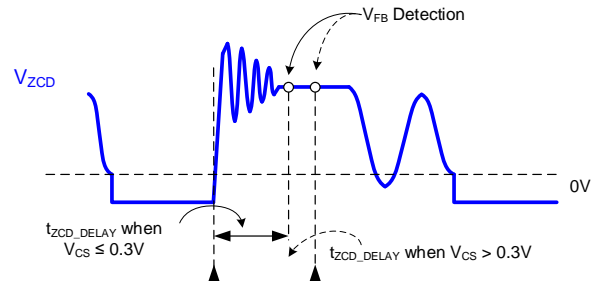

Figure 5: ZCD Sensing Delay Time

**Constant-On-Time (COT) Operation**

To achieve a high power factor under universal input, the MP4078 adopts constant-on-time (COT) control.

Figure 6 shows the internal on-time generation block diagram.

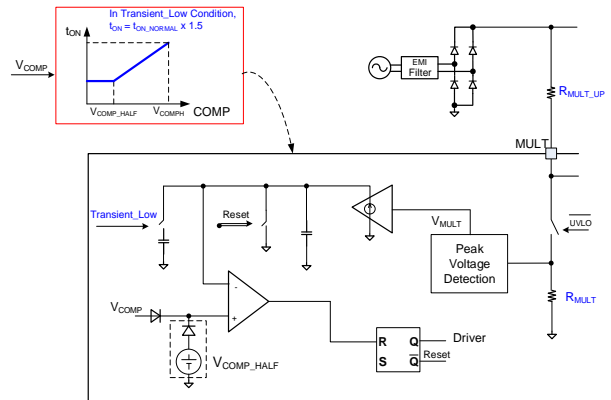

Figure 6: On-Time Generation

In normal operation, the peak voltage on the MULT pin ( $V_{MULT}$ ) represents the input voltage, which is converted to a charge current. This current charges the slew rate capacitor once the external MOSFET turns on and makes the voltage on the capacitor increase linearly. The voltage on the slew rate capacitor is compared to the output of the error amplifier ( $V_{COMP}$ ) for feedback to determine the turn-off time for both the internal and external MOSFETs. When the output load decreases,  $V_{COMP}$  drops accordingly.

As an input of the on-time generation comparator, the value is maintained at a certain voltage ( $V_{COMP\_HALF}$ ) when  $V_{COMP}$  drops below  $V_{COMP\_HALF}$ . That means the on time does not decrease with a constant input voltage. However, it does achieve COT in a sinusoidal period with the whole output load range.



If  $V_{COMP} > V_{COMP\_HALF}$ , the on time can be calculated with Equation (2):

$$t_{ON} = \frac{K_{SLEW} \times V_{COMP}}{V_{MULT}} \quad (2)$$

If  $V_{COMP} \leq V_{COMP\_HALF}$ , the on time is fixed, and can be calculated with Equation (3):

$$t_{ON} = \frac{K_{SLEW} \times V_{COMP\_HALF}}{V_{MULT}} \quad (3)$$

Where  $V_{MULT}$  is the peak voltage on the MULT pin, estimated with Equation (4):

$$V_{MULT} = \frac{\sqrt{2} \times V_{IN\_RMS} \times R_{MULT}}{R_{MULT} + R_{MULT\_UP}} \quad (4)$$

Where  $V_{IN\_RMS}$  is the effective value of the input voltage.

Unlike the variable frequency control of conventional boundary conduction mode, the MP4078 works at an approximate fixed frequency across an input sinusoidal period. The working cycle is inversely proportional to  $V_{COMP}$ , which is determined by the output load. When  $V_{COMP}$  reaches  $V_{COMP\_FULL}$  according to the increasing output load, the MP4078 works at its maximum operating frequency (corresponding to the minimum working cycle,  $t_{CYCLE\_MIN}$ ). The MP4078 lowers its operating frequency when the output load decreases. Its maximum working cycle ( $t_{CYCLE\_MAX}$ ) guarantees output regulation under light-load conditions, and also initiates ultra-low, no-load power consumption.

Figure 7 shows the working cycle and turn-on time curve.

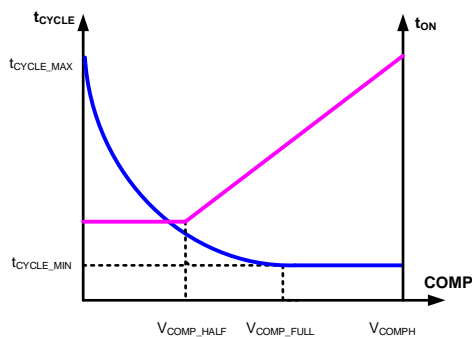

**Figure 7: Working Cycle and Turn-On Time Curve**

### Valley Switching Mode

The MP4078's working cycle (inversely proportional to operating frequency) is determined by  $V_{COMP}$ . However, the MP4078 does not turn on the switch inflexibly when the working cycle ends. The MP4078 optimizes its turn-on logic with zero-current detection through the ZCD pin.

The MP4078 has a ZCD threshold voltage ( $V_{ZCD\_TH}$ , typically 100mV). If the voltage on the ZCD pin exceeds 205mV (105mV hysteresis on  $V_{ZCD\_TH}$ ) then drops below  $V_{ZCD\_TH}$ , the MP4078 recognizes this as a ZCD falling edge. After a working cycle ends, the MP4078 monitors the ZCD pin and turns on the switch with a delay time ( $t_{ZCD\_ON}$ , typically 300ns) since a ZCD falling edge is detected. This decreases the switching loss on both the external and internal MOSFETs for high efficiency. It also guarantees discontinuous conduction mode (DCM) operation.

Figure 8 shows the valley switching.

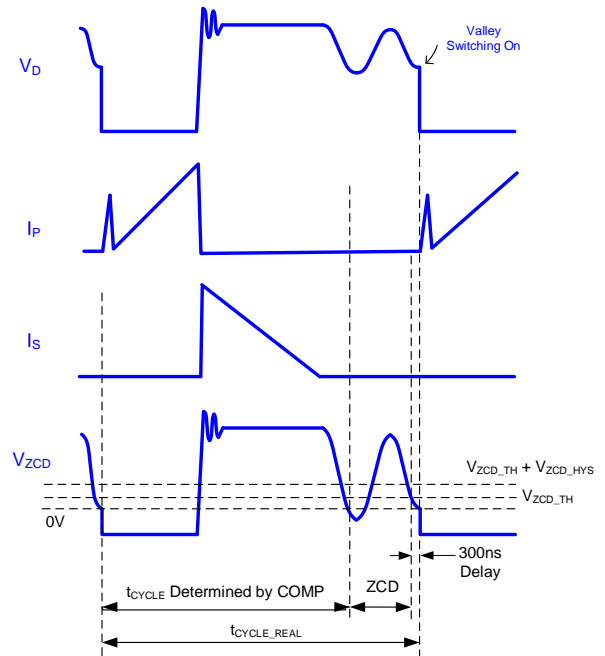

**Figure 8: Valley Switching**

If no ZCD falling edge is detected under particular states (e.g. start-up), the MP4078 turns on the switch via an internal timer with a fixed period ( $t_{START}$ , typically 49 $\mu$ s), unless a fault condition occurs.

### Adjustable Current Limitation

The MP4078 implements cycle-by-cycle current limitation through the S pin. When the voltage on the S pin ( $V_{CS}$ ) reaches the internal current limit, the device immediately stops switching. Unlike a conventional scheme with a fixed current limit, the MP4078 adopts an optimized design to adjust current limitation. Under light-load conditions, the operating frequency decreases according to  $V_{COMP}$ . To reduce the audible noise influence, the current limit is kept at its minimum value ( $V_{CS\_MIN}$ ) when  $V_{COMP}$  drops below  $V_{COMP\_MIN}$ . When the output load increases, the upper limit rises linearly and reaches its maximum value ( $V_{CS\_MAX}$ ) when  $V_{COMP}$  reaches  $V_{COMP\_FULL}$ .

Figure 9 shows adjustable current limitation.

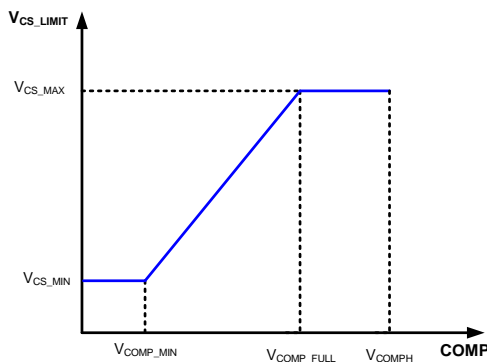

**Figure 9: Adjustable Current Limitation**

### Over-Current Protection (OCP)

If there is an excessive short event or another unexpected condition, the primary current increases sharply out of limitation. To protect the system from damage, the MP4078 integrates independent over-current protection (OCP). If  $V_{CS}$  reaches the OCP threshold ( $V_{CS\_OCP}$ ), the MP4078 stops switching immediately and maintains the latch-off state. The device resets when  $V_{CC}$  falls below  $V_{CCL}$ , then rises up to  $V_{CCH}$  again.

### Fast Transient Response

Due to the low bandwidth, the conventional PFC has slow responses in transient conditions. The MP4078 enhances the dynamic behavior of system through the ZCD pin. In normal operation, the device generates  $V_{FB}$  via the sensed plateau voltage on the ZCD pin. If the output voltage drops and  $V_{FB}$  falls below  $V_{FB\_LOW}$ , the MP4078 forces the on time to increase by 1.5 times  $t_{ON}$

under real-time  $V_{COMP}$ . It also immediately pushes the operating frequency to its maximum value. Then the output voltage stops dropping and returns to its normal value.

If the output voltage rises and  $V_{FB}$  exceeds  $V_{FB\_HIGH}$ , the MP4078 immediately lowers the on time and the operating frequency to their minimum values. Then the output voltage stops rising.

For smooth start-up, the MP4078 enables fast transient response, since the output voltage is set up and  $V_{FB}$  exceeds  $V_{FB\_NORMAL}$  for the first start-up.

### Output Over-Voltage Protection (OVP) and Short-Circuit Protection (SCP)

The MP4078 integrates output over-voltage protection (OVP) and short-circuit protection (SCP) to protect the system from damage. Output OVP and SCP are implemented by detecting  $V_{FB}$ . If  $V_{FB}$  exceeds the OVP threshold ( $V_{FB\_OVP}$ ), the MP4078 stops switching and enters latch-off mode.

If an output short circuit occurs during normal operation,  $V_{FB}$  drops according to the output voltage. If  $V_{FB}$  falls below  $V_{FB\_SCP}$ , the MP4078 does not detect the ZCD falling edge, and works with a start timer period ( $t_{START}$ , typically 49 $\mu$ s). If this conditions remains for the output short-circuit protection duration ( $t_{SCP}$ , typically 2.3ms), the device recognizes an SCP condition. Then the MP4078 stops switching and latches off.

During start-up, consider setting  $V_{FB}$  to avoid mistriggering SCP. To prevent a mistrigger, the MP4078 implements an output short-circuit protection period during start-up ( $t_{SCP\_STARTUP}$ , typically 100ms).

The MP4078 shuts down during OVP and SCP. It does not turn on again until the chip is reset when  $V_{CC}$  drops below  $V_{CCL}$  then rises up to  $V_{CCH}$  again.

### Brownout Protection

The MP4078 integrates brownout protection. The device detects the peak value ( $V_{MULT}$ ) of the divided rectified input voltage through the MULT pin. If  $V_{MULT}$  drops below the brownout threshold ( $V_{MULT\_BO}$ ) and lasts for a brownout-detection time ( $t_{MULT\_BO}$ ), the MP4078 recognizes the brownout condition and shuts down the device.

The MP4078 is released from brownout protection when  $V_{MULT}$  exceeds the brown-in threshold ( $V_{MULT\_BI}$ ) with a hysteresis ( $V_{MULT\_BO\_HYS}$ ).

### **Thermal Shutdown**

To protect the chip from a thermal hazard, the MP4078 shuts down if the junction temperature exceeds the thermal shutdown threshold ( $T_{TSD}$ , typically 160°C) and indicates a fault. The MP4078 keeps the switching off until the following conditions are met:

- The temperature drops below about 100°C (typically a 60°C hysteresis)
- $V_{CC}$  drops below  $V_{CCL}$ , then rises up to  $V_{CCH}$  again

Then the MP4078 works normally.

## APPLICATION INFORMATION

### Selecting the Input Capacitor

If using the MP4078 for a PFC application, do not place a bulk capacitor after the bridge rectifier. Place a bypass capacitor after the bridge rectifier to filter the high-frequency switching ripple across the rectified input voltage with twice the AC line frequency. Under universal input conditions, a 0.22μF to 0.47μF CBB capacitor is recommended for a 30W output power application.

Because there is no bulk capacitor placed at the input, there may be notable surge protection weakness. To improve the reliability during a surge test without sacrificing PF or THD performance, it is recommended to use a circuit with few external components (see Figure 10).

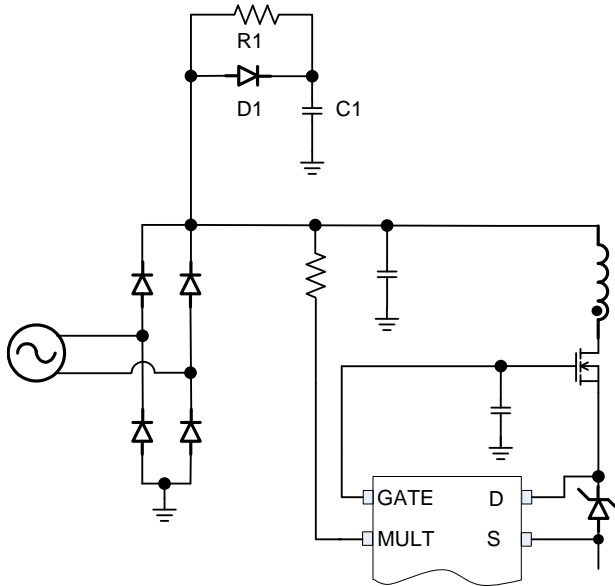

**Figure 10: External Circuit for Surge Protection**

A larger capacitance with C1 results in improved surge protection. It is recommended to use a 1μF to 2.2μF electrolytic capacitor to pass EN61000-4-5, ±1kV level specifications. R1 is the dissipated resistor for C1, and it is recommended for R1 to be several hundred to thousands of kΩ.

### Selecting the Transformer

The MP4078 works in DCM due to its control mode across the whole operating input range. For improved efficiency in low line, it is recommended to make the MP4078 work in an approaching boundary conduction mode at the peak of low-line input voltage. The duty cycle

( $D_{MAX}$ ) at the peak of the low-line input voltage can be estimated with Equation (5):

$$D_{MAX} \approx \frac{(V_O + V_{DIODE}) \times N}{(V_O + V_{DIODE}) \times N + \sqrt{2} \times V_{IN\_RMS\_MIN}} \quad (5)$$

Where N is the turning ratio of the primary and secondary winding, and  $V_{IN\_RMS\_MIN}$  is the effective value of the low-line input voltage.

The maximum turn-on time ( $t_{ON\_MAX}$ ) of the primary MOSFET can be estimated with Equation (6):

$$t_{ON\_MAX} = D_{MAX} \times t_{CYCLE\_MIN} \quad (6)$$

Where  $t_{CYCLE\_MIN}$  is the configured minimum working cycle.

The input power ( $P_{IN\_MAX}$ ) at the low-line input can be calculated with Equation (7):

$$P_{IN\_MAX} = \frac{V_O \times I_O}{\eta} \quad (7)$$

Where  $I_O$  is the rated output current, and  $\eta$  is the estimated efficiency of the low-line input.

The maximum peak for the primary-side current ( $I_{PRI\_PK\_MAX}$ ) can be estimated with Equation (8):

$$I_{PRI\_PK\_MAX} = \frac{2\sqrt{2} \times P_{IN\_MAX}}{V_{IN\_RMS\_MIN} \times D_{MAX}} \quad (8)$$

The maximum effective value of the primary-side current ( $I_{PRI\_RMS\_MAX}$ ) can be estimated with Equation (9):

$$I_{PRI\_RMS\_MAX} = I_{PRI\_PK\_MAX} \times \sqrt{\frac{D_{MAX}}{6}} \quad (9)$$

The primary-side inductance ( $L_M$ ) can be calculated with Equation (10):

$$L_M = \frac{\sqrt{2} \times V_{IN\_RMS\_MIN} \times t_{ON\_MAX}}{I_{PRI\_PK\_MAX}} \quad (10)$$

Then the required maximum area product ( $AP_{MAX}$ ) of the transformer can be calculated with Equation (11):

$$AP_{MAX} = \frac{L_M \times I_{PRI\_RMS\_MAX} \times I_{PRI\_PK\_MAX} \times (\sqrt{D_{MAX}} + \sqrt{1-D_{MAX}})}{B_{MAX} \times K_U \times J \times \sqrt{D_{MAX}}} \quad (11)$$

Where  $B_{MAX}$  is the maximum allowable flux density (T) (typically 0.2T to 0.3T for common ferrite cores),  $K_U$  is the window factor of the transformer (typically 0.15 to 0.3), and  $J$  is the current density coefficient (typically 4A/mm<sup>2</sup> to 6A/mm<sup>2</sup>).

Choose a ferrite core with an effective area product ( $AP_{REAL}$ ) that exceeds  $AP_{MAX}$ . Calculate the turns on the primary winding ( $N_P$ ) and secondary winding ( $N_S$ ) with Equation (12) and Equation (13), respectively:

$$N_P = \frac{L_M \times I_{PRI\_PK\_MAX}}{B_{MAX} \times A_E} \quad (12)$$

$$N_S = \frac{N_P}{N} \quad (13)$$

Where  $A_E$  is the effective core area.

The auxiliary winding provides the power supply for the MP4078 through a diode on the VCC pin during normal operation. The auxiliary winding ( $N_{AUX}$ ) can be estimated with Equation (14):

$$N_{AUX} = \frac{V_{CC\_NOM} + V_{DIODE\_AUX}}{V_O + V_{DIODE}} \times N_S \quad (14)$$

Where  $V_{CC\_NOM}$  is the voltage on the VCC pin during normal operation, and  $V_{DIODE\_AUX}$  is the forward voltage of VCC diode.

Ensure the inductance leakage on the transformer is sufficiently low. This helps to decrease the switching spike for ZCD sensing and EMI performance.

### Selecting the External Pull-Up Resistor on MULT

The peak voltage on the MULT pin ( $V_{MULT}$ ) is directly related to the on time, and is determined by the external pull-up resistor on the MULT pin ( $R_{MULT\_UP}$ ) and the internal pull-down resistor ( $R_{MULT}$ ).

In most cases, it is recommended to match the output of the error amplifier ( $V_{COMP}$ ) with the  $V_{COMP\_FULL}$  value under full-load conditions. The corresponding on time is the turn-on time during full-load conditions ( $t_{ON\_FULL}$ ) (see Figure 11).

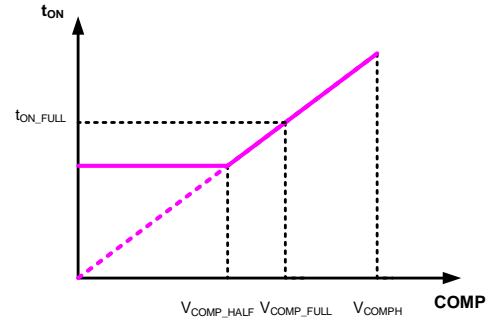

**Figure 11:  $t_{ON}$  vs  $V_{COMP}$**

$R_{MULT\_UP}$  can be estimated with Equation (15):

$$R_{MULT\_UP} = R_{MULT} \times \left( \frac{\sqrt{2} \times V_{IN\_RMS\_MIN} \times t_{ON\_MAX}}{K_{SLEW} \times V_{COMP\_FULL}} - 1 \right) \quad (15)$$

### Selecting the Current-Sense Resistor

A proper current-sense resistor both ensures normal operation across the output load range and implements cycle-by-cycle current limitation to guarantee circuit reliability in the event of an overload condition.

The current-sense resistor ( $R_{SENSE}$ ) can be calculated with Equation (16):

$$R_{SENSE} = \frac{V_{CS\_MAX}}{\alpha_{OL} \times I_{PRI\_PK\_MAX}} \quad (16)$$

Where  $V_{CS\_MAX}$  is the maximum current limit (typically 880mV), and  $\alpha_{OL}$  is the coefficient of the peak primary-side current during overload (1.3 to 1.5 is typically recommended).

### Selecting the External Primary MOSFET

The drain-source voltage rating and current rating are two dominant factors to consider when choosing the external primary MOSFET. The maximum drain-to-source voltage ( $V_{DS\_EXT\_MAX}$ ) appears at the high-line input voltage ( $V_{IN\_RMS\_MAX}$ ).  $V_{DS\_EXT\_MAX}$  can be calculated with Equation (17):

$$V_{DS\_EXT\_MAX} = \sqrt{2} \times V_{IN\_RMS\_MAX} + N \times (V_O + V_{DIODE}) + \Delta V_{PRI\_SPIKE} \quad (17)$$

Where  $\Delta V_{PRI\_SPIKE}$  is the turn-off spike on an external MOSFET. This spike is caused by parasitic parameters and the transformer's leakage inductance. With proper transformer and primary snubber design, this value should not exceed 100V in normal operation for universal input applications.

The maximum effective current on the drain-to-source is the maximum effective primary-side current ( $I_{PRI\_RMS\_MAX}$ ) that appears at the low-line input voltage ( $V_{IN\_RMS\_MIN}$ ). It can be calculated with Equation (9).

### Selecting the Secondary Rectifier

The maximum voltage across the secondary rectifier ( $V_{SREC\_MAX}$ ) also appears at the high-line input voltage and can be calculated with Equation (18):

$$V_{SREC\_MAX} = V_O + \frac{\sqrt{2} \times V_{IN\_RMS\_MAX}}{N} + \Delta V_{SEC\_SPIKE} \quad (18)$$

Where  $\Delta V_{SEC\_SPIKE}$  is the switching spike on the secondary rectifier. It is recommended to choose a low-voltage rectifier with a properly designed transformer and secondary snubber for efficiency.

For rectifier diode selection, the maximum current rating is the maximum average forward rectified current, which is equal to the rated output current ( $I_O$ ).

### Selecting the ZCD Resistor Divider

The MP4078 uses the ZCD pin for multiple functions. Besides indicating the output voltage, the ZCD divider also determines the initial configuration for the minimum working cycle.

The paralleled resistance of ZCD ( $R_{ZCD\_PARALLEL}$ ) must follow the required  $t_{CYCLE\_MIN}$  values (see Table 1 on page 15).  $R_{ZCD\_PARALLEL}$  can be calculated with Equation (19):

$$R_{ZCD\_PARALLEL} = \frac{R_{ZCD1} \times R_{ZCD2}}{R_{ZCD1} + R_{ZCD2}} \quad (19)$$

Meanwhile, the upper ZCD resistor divider ( $R_{ZCD1}$ ) can be calculated with Equation (20):

$$R_{ZCD1} = \frac{V_O + V_{DIODE}}{V_{REF} \times R_{ZCD\_PARALLEL}} \times \frac{N_{AUX}}{N_S} \quad (20)$$

The down resistor of the ZCD divider ( $R_{ZCD2}$ ) can also be calculated with Equation (19).

### Selecting the Output Capacitor

To achieve a high PF, the bandwidth of the control loop is very slow (typically below 100Hz). This means a large voltage ripple may appear across the output capacitor.

This ripple has two components. One is related to the high-frequency triangles by transformer magnetizing current, which is mostly dependent on the ESR of the output capacitor. Another is related to the twice line frequency envelope from rectified input voltage, which is mostly determined by the capacitance value.

The output ripple ( $\Delta V_{O\_RIPPLE}$ ) has a relationship with the output capacitance ( $C_{OUT}$ ) that can be estimated with Equation (21):

$$\Delta V_{O\_RIPPLE} = I_O \times \sqrt{\frac{1}{(2\pi \times 2f_{LINE} \times C_{OUT})^2} + R_{ESR}^2} \quad (21)$$

Where  $f_{LINE}$  is the frequency of the input line voltage, and  $R_{ESR}$  is the ESR of the output capacitor.

Use low-ESR capacitors in parallel on the output. The high-frequency switching ripple can be negligible.





EVALUATION DESIGN CIRCUIT

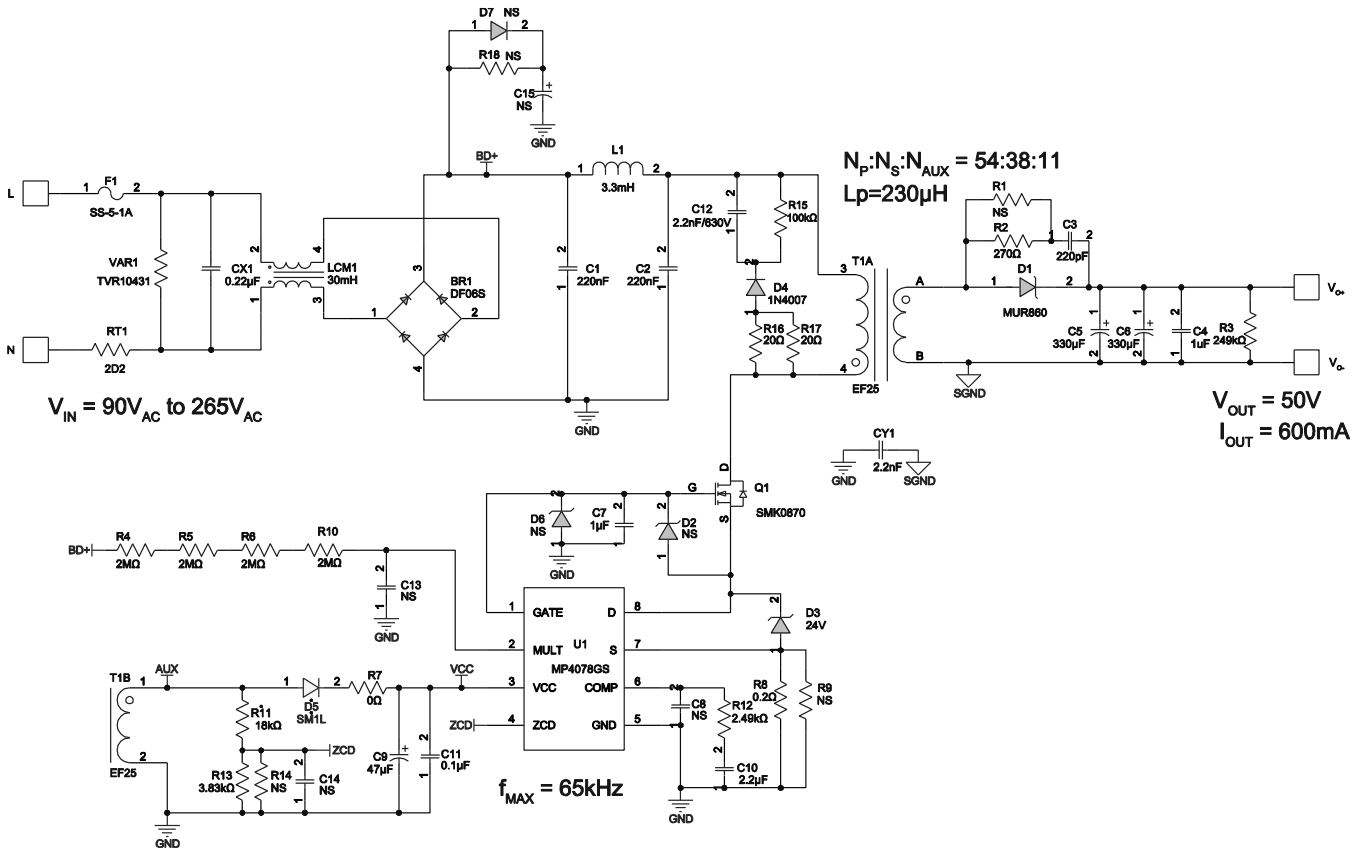
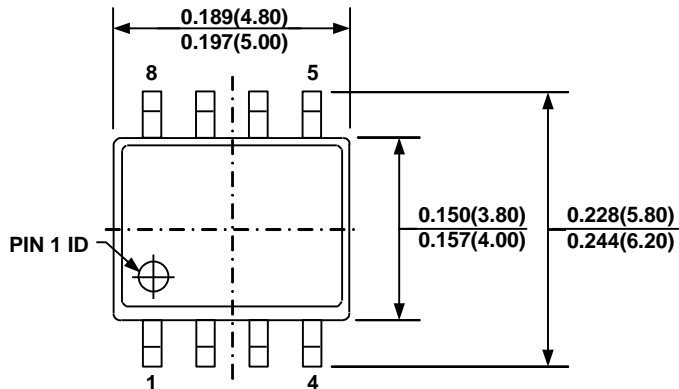

Figure 13: Evaluation Board Schematic  
 EV4078-S-00A: 90V<sub>AC</sub> to 265V<sub>AC</sub> Input, 50V/600mA Output



## PACKAGE INFORMATION

## SOIC-8



TOP VIEW

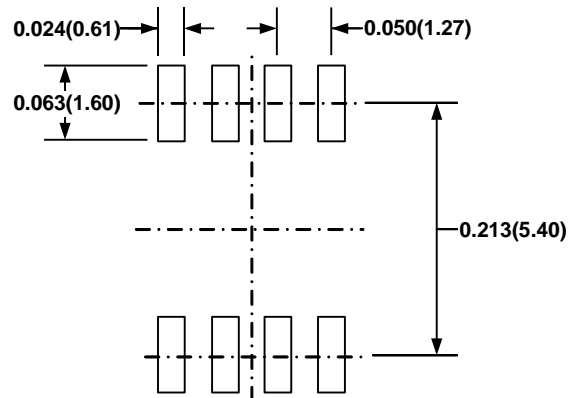

RECOMMENDED LAND PATTERN

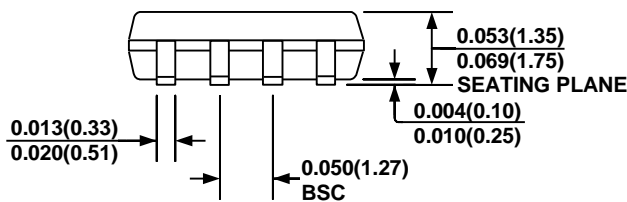

FRONT VIEW

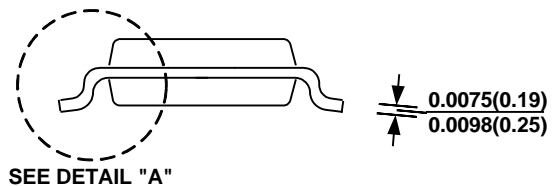

SIDE VIEW

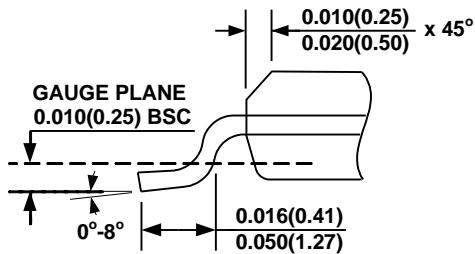

DETAIL "A"

## NOTE:

- CONTROL DIMENSION IS IN INCHES. DIMENSION IN BRACKET IS IN MILLIMETERS.
- PACKAGE LENGTH DOES NOT INCLUDE MOLD FLASH, PROTRUSIONS OR GATE BURRS.
- PACKAGE WIDTH DOES NOT INCLUDE INTERLEAD FLASH OR PROTRUSIONS.
- LEAD COPLANARITY (BOTTOM OF LEADS AFTER FORMING) SHALL BE 0.004" INCHES MAX.
- DRAWING CONFORMS TO JEDEC MS-012, VARIATION AA.
- DRAWING IS NOT TO SCALE.

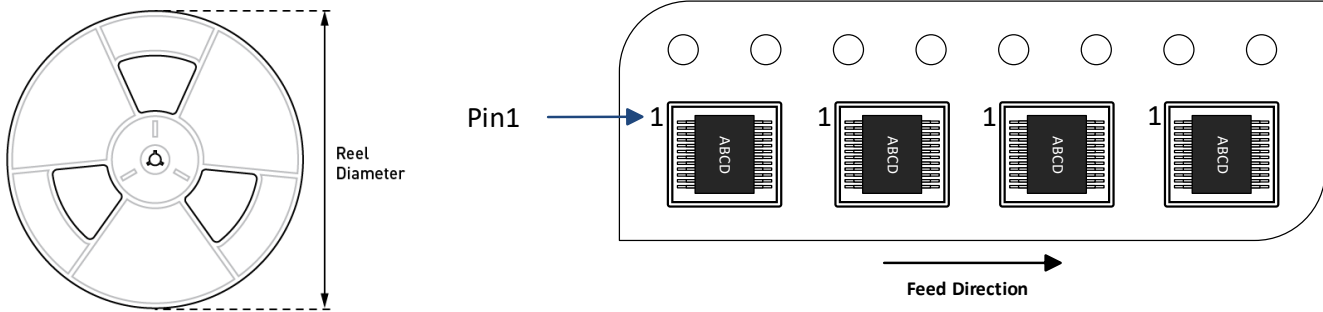
**CARRIER INFORMATION**

Part Number	Package Description	Quantity/ Reel	Quantity/ Tube	Quantity/ Tray	Reel Diameter	Carrier Tape Width	Carrier Tape Pitch
MP4078GS-Z	SOIC-8	2500	100	N/A	13in	12mm	8mm

## Revision History

Revision #	Revision Date	Description	Pages Updated
1.0	7/21/2020	Initial Release	-

**Notice:** The information in this document is subject to change without notice. Please contact MPS for current specifications. Users should warrant and guarantee that third-party Intellectual Property rights are not infringed upon when integrating MPS products into any application. MPS will not assume any legal responsibility for any said applications.