

# NCP1124, NCP1126, NCP1129

## High Voltage Switcher for Offline Power Supplies

The NCP112x products integrates a fixed-frequency peak current mode controller with a low on-resistance, 650 V MOSFET. Available in a PDIP-7 package, the NCP112x offers a high level of integration, including soft-start, frequency-jittering, short-circuit protection, thermal shutdown protection, frequency foldback mode and skip-cycle to reduce power consumption in light load condition, peak current mode control with adjustable internal ramp compensation and adjustable peak current set point.

During nominal load operation, the part switches at one of the available frequencies (65 or 100 kHz). When the output power demand diminishes, the IC automatically enters frequency foldback mode and provides excellent efficiency at light loads. When the power demand reduces further, it enters into a skip mode to reduce the standby consumption down to no load condition.

Protection features include: a timer to detect an overload or a short-circuit event with auto-recovery or latch protection, and a built-in  $V_{CC}$  overvoltage protection.

The switcher also provides a jittered 65 kHz or 100 kHz switching frequency to improve the EMI.

### Features

- Built-in 650 V, 1 A MOSFET with  $R_{DS(on)}$  of 8.6  $\Omega$  for NCP1124
- Built-in 650 V, 1.8 A MOSFET with  $R_{DS(on)}$  of 5.4  $\Omega$  for NCP1126
- Built-in 650 V, 5.5 A MOSFET with  $R_{DS(on)}$  of 2.1  $\Omega$  for NCP1129
- Fixed-Frequency 65 or 100 kHz Current Mode Control with Adjustable Internal Ramp Compensation
- Adjustable Current Limit with External Resistor
- Frequency Foldback Down to 26 kHz and Skip-Cycle for Light Load Efficiency
- Frequency Jittering for EMI Improvement
- Less than 100 mW Standby Power @ High Line
- EPS 2.0 Compliant
- 7-Pin Package Provides Creepage Distance
- These are Pb-Free Devices

**Table 1. OUTPUT POWER TABLE** (Note 1)

Product	230 Vac $\pm$ 15% (Note 4)		85 – 265 Vac	
	Adapter (Note 2)	Peak or Open Frame (Note 3)	Adapter (Note 2)	Peak or Open Frame (Note 3)
NCP1124	12 W	27 W	6 W	14 W
NCP1126	15 W	32 W	10 W	17 W
NCP1129	28 W	43 W	20 W	26.5 W

1. 12 V output voltage with 135 V reflected output voltage
2. Typical continuous power in a non-ventilated enclosed adaptor measured at 50°C ambient temperature.
3. Maximum practical continuous power in an open-frame design at 50°C ambient temperature
4. 230 V<sub>AC</sub> or 115 V<sub>AC</sub> with voltage doubler.



**ON Semiconductor®**

[www.onsemi.com](http://www.onsemi.com)

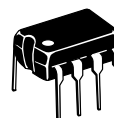

PDIP-7  
P SUFFIX  
CASE 626B

### MARKING DIAGRAMS

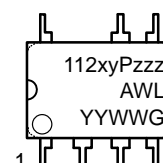

- x = Specific Device Code  
4 = NCP1124  
6 = NCP1126  
9 = NCP1129
- y = A or B  
A = Latch  
B = Auto-recovery
- zzz = Frequency  
65 = 65 kHz  
100 = 100 kHz
- A = Assembly Location
- WL = Wafer Lot
- YY = Year
- WW = Work Week
- G = Pb-Free Package

### ORDERING INFORMATION

See detailed ordering and shipping information on page 17 of this data sheet.

# NCP1124, NCP1126, NCP1129

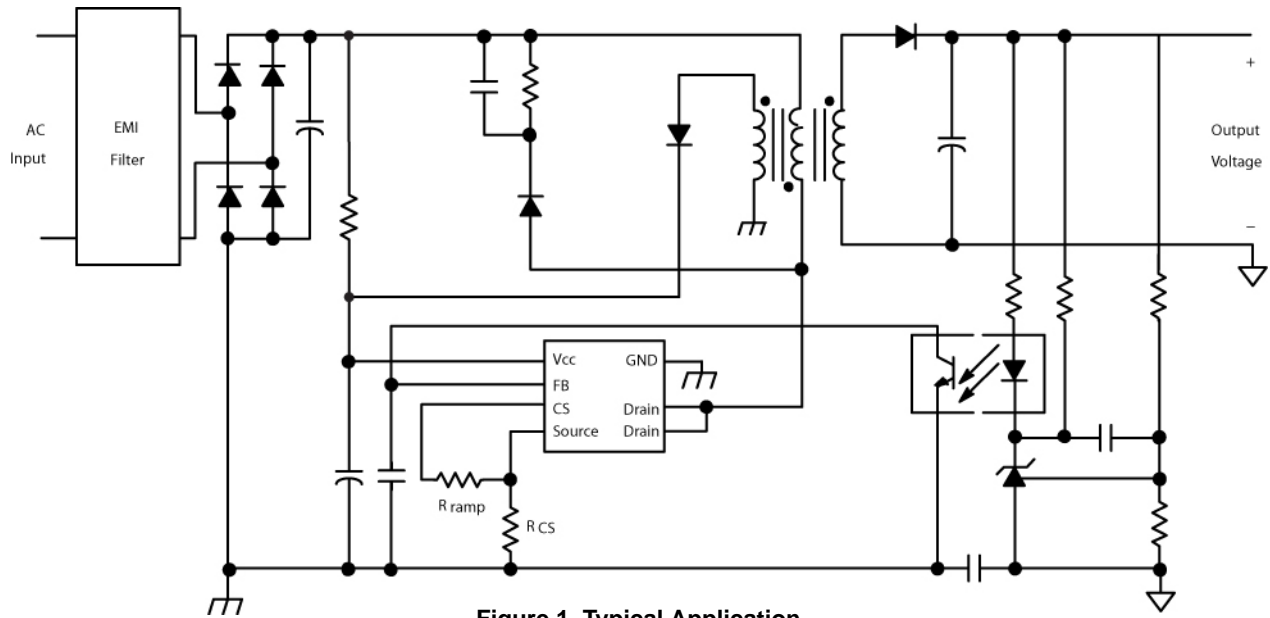

Figure 1. Typical Application

Table 2. PIN FUNCTION DESCRIPTION

Pin No.	Pin Name	Pin Description
1	VCC	This pin is connected to an external auxiliary voltage and supplies the controller. When above a certain level, the part fully latches off.
2	FB	Feedback input. Hooking an optocoupler collector to this pin will allow regulation.
3	CS	This pin monitors the primary peak current but also offers a means to introduce ramp compensation.
4	Source	Source of the internal MOSFET. This pin is typically connected to the source of a grounded sense resistor.
5	Drain	The drain of the internal MOSFET. These pins connect to the transformer terminal and can withstand up to 650 V.
6	Drain	
7	-	Removed for creepage distance.
8	GND	Ground reference.

Table 3. OPTIONS

Switcher	Package	Frequency	Short-Circuit Protection
NCP1124AP65G	PDIP-7	65 kHz	Latch
NCP1124BP65G	PDIP-7	65 kHz	Auto-Recovery
NCP1124AP100G	PDIP-7	100 kHz	Latch
NCP1124BP100G	PDIP-7	100 kHz	Auto-Recovery
NCP1126AP65G	PDIP-7	65 kHz	Latch
NCP1126BP65G	PDIP-7	65 kHz	Auto-Recovery
NCP1126AP100G	PDIP-7	100 kHz	Latch
NCP1126BP100G	PDIP-7	100 kHz	Auto-Recovery
NCP1129AP65G	PDIP-7	65 kHz	Latch
NCP1129BP65G	PDIP-7	65 kHz	Auto-Recovery
NCP1129AP100G	PDIP-7	100 kHz	Latch
NCP1129BP100G	PDIP-7	100 kHz	Auto-Recovery

# NCP1124, NCP1126, NCP1129

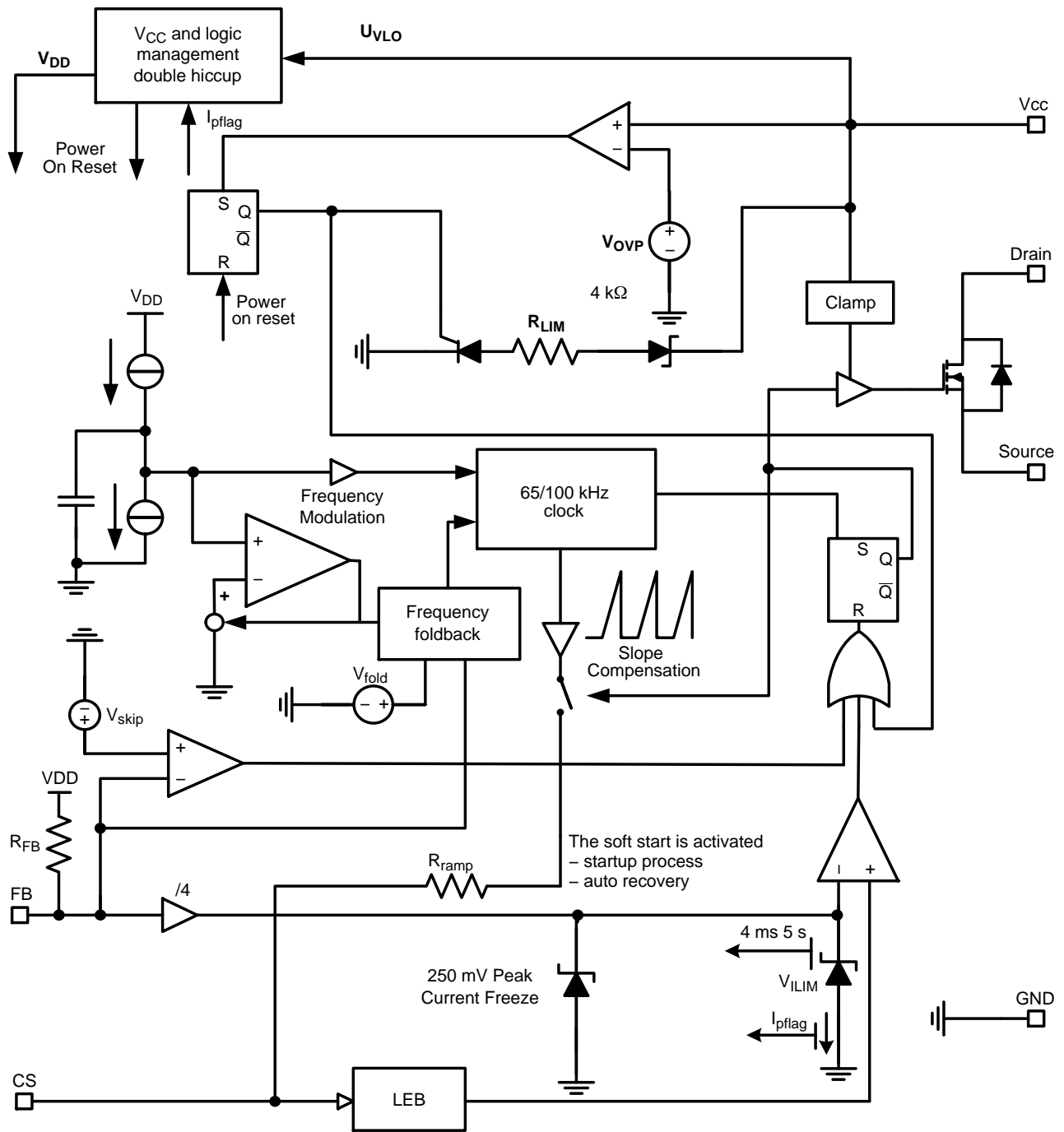

Figure 2. Functional Block Diagram

## NCP1124, NCP1126, NCP1129

**Table 4. MAXIMUM RATINGS** (Note 5)

Rating		Symbol	Value	Unit
Drain Input Voltage (Referenced to Source Terminal)	NCP112x	$V_{\text{Drain}}$	-0.3 to 650	V
Drain Maximum Pulsed Current (10 $\mu\text{s}$ Single Pulse, $T_J = 25^\circ\text{C}$ )	NCP1129	$I_{\text{DM}}$	27	A
	NCP1126		11	
	NCP1124		7	
Single Pulse Avalanche Energy	NCP1126, NCP1129 NCP1124	$E_{\text{AS}}$	96 60	mJ
Supply Input Voltage		$V_{\text{CC(MAX)}}$	-0.3 to 35	V
Current Sense Input Voltage		$V_{\text{CS}}$	-0.3 to 10	V
Feedback Input Voltage		$V_{\text{FB}}$	-0.3 to 10	V
Operating Junction Temperature		$T_J$	-40 to 150	$^\circ\text{C}$
Storage Temperature Range		$T_{\text{STG}}$	-60 to 150	$^\circ\text{C}$
Power Dissipation ( $T_A = 25^\circ\text{C}$ , 2 Oz Cu, 600 mm <sup>2</sup> Printed Circuit Copper Clad)		$P_D$	1.5	W
Thermal Resistance, Junction to Ambient 2 Oz Cu Printed Circuit Copper Clad Low Conductivity (Note 6) High Conductivity (Note 7)		$R_{\theta\text{JA}}$	128	$^\circ\text{C/W}$
			78	
ESD Capability (Note 8) Human Body Model ESD Capability per JEDEC JESD22-A114F. Machine Model ESD Capability per JEDEC JESD22-A115C. Charged-Device Model ESD Capability per JEDEC JESD22-C101E.			2000	V
			200	
			500	

Stresses exceeding those listed in the Maximum Ratings table may damage the device. If any of these limits are exceeded, device functionality should not be assumed, damage may occur and reliability may be affected.

5. This device contains Latch-Up protection and exceeds  $\pm 100$  mA per JEDEC Standard JESD78.

6. Low Conductivity Board. As mounted on 40 x 40 x 1.5 mm FR4 substrate with a single layer of 50 mm<sup>2</sup> of 2 oz copper trances and heat spreading area. As specified for a JEDEC 51 low conductivity test PCB. Test conditions were under natural convection of zero air flow.

7. High Conductivity Board. As mounted on 40 x 40 x 1.5 mm FR4 substrate with a single layer of 600 mm<sup>2</sup> of 2 oz copper trances and heat spreading area. As specified for a JEDEC 51 high conductivity test PCB. Test conditions were under natural convection of zero air flow.

8. The Drain pins (5 and 6), are rated to the maximum voltage of the device, or 650 V.

# NCP1124, NCP1126, NCP1129

**Table 5. ELECTRICAL CHARACTERISTICS**

 ( $V_{CC} = 12\text{ V}$ , for typical values  $T_J = 25^\circ\text{C}$ , for min/max values,  $T_J$  is  $-40^\circ\text{C}$  to  $125^\circ\text{C}$ , unless otherwise noted)

Characteristics	Conditions	Symbol	Min	Typ	Max	Unit
<b>STARTUP AND SUPPLY CIRCUITS</b>						
Supply Voltage Startup Threshold Minimum Operating Voltage Operating Hysteresis	$V_{CC}$ increasing $V_{CC}$ decreasing $V_{CC(ON)} - V_{CC(OFF)}$	$V_{CC(ON)}$ $V_{CC(OFF)}$ $V_{CC(HYS)}$	15.75 7.75 6.0	17 8.5 –	20 9.25 –	V
$V_{CC}$ Overvoltage Protection Threshold		$V_{CC(OVP)}$	26.3	28	29.3	V
$V_{CC}$ Overvoltage Protection Filter Delay		$t_{OVP(\text{delay})}$	–	26	–	$\mu\text{s}$
$V_{CC}$ Clamp Voltage in Latch Mode	$I_{CC} = 500\ \mu\text{A}$	$V_{ZENER}$	5	6.2	7.15	V
Supply Current Startup Current Skip Current Operating Current at 65 kHz Operating Current at 100 kHz	$V_{CC} = V_{CC(ON)} - 0.5\text{ V}$ $V_{FB} = V_{\text{skip}} - 0.1\text{ V}$ $I_{FB} = 50\ \mu\text{A}$ , $f_{\text{SW}} = 65\text{ kHz}$ $I_{FB} = 50\ \mu\text{A}$ , $f_{\text{SW}} = 100\text{ kHz}$	$I_{CC1}$ $I_{CC2}$ $I_{CC3}$ $I_{CC4}$	– – – –	– 700 1900 3300	15 900 3100 4000	$\mu\text{A}$
Current Consumption in Latch Mode	$T_J = -40^\circ\text{C}$ to $125^\circ\text{C}$	$I_{CC(\text{latch})}$	42	–	–	$\mu\text{A}$
<b>POWER SWITCH CIRCUIT</b>						
Off–State Leakage Current	$T_J = 125^\circ\text{C}$ , $V_{\text{Drain}} = 650\text{ V}$	$I_{\text{Drain(off)}}$	–	–	20	$\mu\text{A}$
Breakdown Voltage	$T_J = 25^\circ\text{C}$ , $I_{\text{Drain}} = 250\ \mu\text{A}$ , $V_{\text{FB}} = 0\text{ V}$	$V_{\text{BR(DSS)}}$	650	–	–	V
ON State Resistance	$I_{\text{Drain}} = 100\text{ mA}$ $V_{CC} = 10\text{ V}$ , $T_J = 25^\circ\text{C}$ $V_{CC} = 10\text{ V}$ , $T_J = 125^\circ\text{C}$ $V_{CC} = 10\text{ V}$ , $T_J = 25^\circ\text{C}$ $V_{CC} = 10\text{ V}$ , $T_J = 125^\circ\text{C}$ $V_{CC} = 10\text{ V}$ , $T_J = 25^\circ\text{C}$ $V_{CC} = 10\text{ V}$ , $T_J = 125^\circ\text{C}$	$R_{\text{DS(on)}}$	– – – – – –	2.1 – 5.4 – 9.0 –	2.75 5.0 7.7 13.1 13.2 23.5	$\Omega$
Output Capacitance	$V_{\text{DS}} = 25\text{ V}$ , $V_{CC} = 0\text{ V}$ , $f = 1\text{ MHz}$ $V_{\text{DS}} = 25\text{ V}$ , $V_{CC} = 0\text{ V}$ , $f = 1\text{ MHz}$ $V_{\text{DS}} = 25\text{ V}$ , $V_{CC} = 0\text{ V}$ , $f = 1\text{ MHz}$	$C_{\text{OSS}}$	– – –	67.3 29.2 16.5	– – –	pF
Switching Characteristics						ns
NCP1124	Rise Time Fall Time	$(V_{\text{DS}} = 325\text{ V}$ , $I_{\text{Drain}} = 1\text{ A}$ , $V_{\text{GS}} = 10\text{ V}$ , $R_g = 4.7\ \Omega$ )	$t_r$ $t_f$	– –	4.25 9.32	– –
NCP1126	Rise Time Fall Time	$(V_{\text{DS}} = 325\text{ V}$ , $I_{\text{Drain}} = 1.8\text{ A}$ , $V_{\text{GS}} = 10\text{ V}$ , $R_g = 4.7\ \Omega$ )	$t_r$ $t_f$	– –	7.44 5.94	– –
NCP1129	Rise Time Fall Time	$(V_{\text{DS}} = 325\text{ V}$ , $I_{\text{Drain}} = 5.5\text{ A}$ , $V_{\text{GS}} = 10\text{ V}$ , $R_g = 4.7\ \Omega$ )	$t_r$ $t_f$	– –	7.54 5.94	– –
<b>CURRENT SENSE</b>						
Current Sense Voltage Threshold	$V_{\text{CS}}$ increasing, $T_J = 25^\circ\text{C}$ $V_{\text{CS}}$ increasing	$V_{\text{ILIM1}}$ $V_{\text{ILIM2}}$	730 720	785 800	840 880	mV
Cycle by Cycle Current Sense Propagation Delay	$V_{\text{CS}}\text{ dv/dt} = 1\text{ V}/\mu\text{s}$ , measured from $V_{\text{ILIM1}}$ to DRV falling edge	$t_{\text{CS(delay)}}$	– – –	100 50 50	150 150 150	ns
Cycle by Cycle Leading Edge Blanking Duration		$t_{\text{CS(LEB)}}$	–	320	400	ns
<b>INTERNAL OSCILLATOR</b>						
Oscillation Frequency	65 kHz Version 100 kHz Version	$f_{\text{OSC1}}$ $f_{\text{OSC2}}$	61 92	65 100	71 108	kHz
Maximum Duty Ratio		$D_{\text{MAX}}$	78	80	82	%
Frequency Jittering in Percentage of $f_{\text{OSC}}$		$f_{\text{jitter}}$	–	$\pm 5$	–	%

# NCP1124, NCP1126, NCP1129

**Table 5. ELECTRICAL CHARACTERISTICS**

( $V_{CC} = 12\text{ V}$ , for typical values  $T_J = 25^\circ\text{C}$ , for min/max values,  $T_J$  is  $-40^\circ\text{C}$  to  $125^\circ\text{C}$ , unless otherwise noted)

Characteristics	Conditions	Symbol	Min	Typ	Max	Unit
<b>FEEDBACK SECTION</b>						
Internal Pull-up Resistor		$R_{up}$	–	13	–	$k\Omega$
Equivalent ac resistor from FB to GND		$R_{eq}$	–	15	–	$k\Omega$
$V_{FB}$ to Internal Current Setpoint Division Ratio		$I_{ratio}$	–	4	–	–
Feedback Voltage Below Which the Peak Current is Frozen		$V_{FB(freeze)}$	0.85	1	1.15	V
<b>FREQUENCY FOLDBACK</b>						
Frequency Foldback Level on the FB	47% of maximum peak current	$V_{FB(fold)}$	1.35	1.5	1.78	V
Transition Frequency Below Which Skip-Cycle occurs		$f_{trans}$	22	26	30	kHz
Feedback voltage level when Frequency Foldback ends	$f_{SW} = f_{MIN}$	$V_{FB(fold,end)}$	410	450	490	mV
Skip-Cycle Level Voltage on The FB pin		$V_{skip}$	360	400	440	mV
Hysteresis on The Skip Comparator		$V_{skip(HYS)}$	–	40	–	mV
<b>FAULT PROTECTION</b>						
Soft-Start Period	Measured from 1 <sup>st</sup> drive pulse to $V_{CS} = V_{ILIM}$	$t_{SSTART}$	–	4.0	–	ms
Overload Fault Timer	$V_{CS} = V_{ILIM}$	$t_{OVL D}$	35	50	65	ms
<b>TEMPERATURE MANAGEMENT</b>						
Temperature Shutdown	(Note 9)	TSD	130	–	–	$^\circ\text{C}$
Hysteresis	Guaranteed by Design		–	20	–	$^\circ\text{C}$

Product parametric performance is indicated in the Electrical Characteristics for the listed test conditions, unless otherwise noted. Product performance may not be indicated by the Electrical Characteristics if operated under different conditions.

9. The value is not subjected to production test – verified by design/characterization. The thermal shutdown temperature refers to the junction temperature of the controller.

# NCP1124, NCP1126, NCP1129

## TYPICAL CHARACTERISTICS

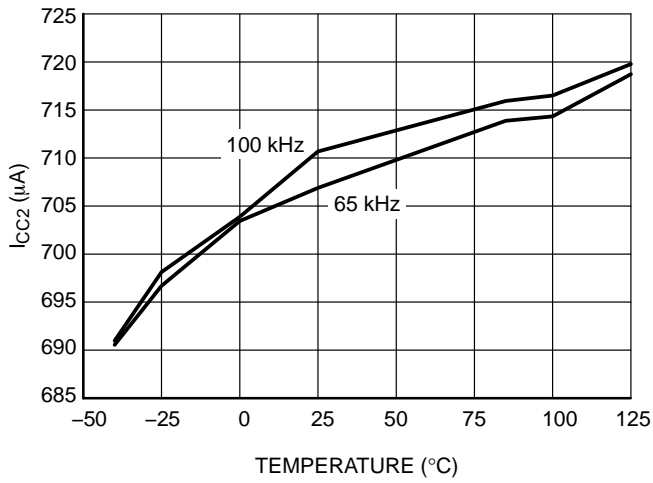

**Figure 3. NCP1124  $I_{CC2}$  vs. Junction Temperature**

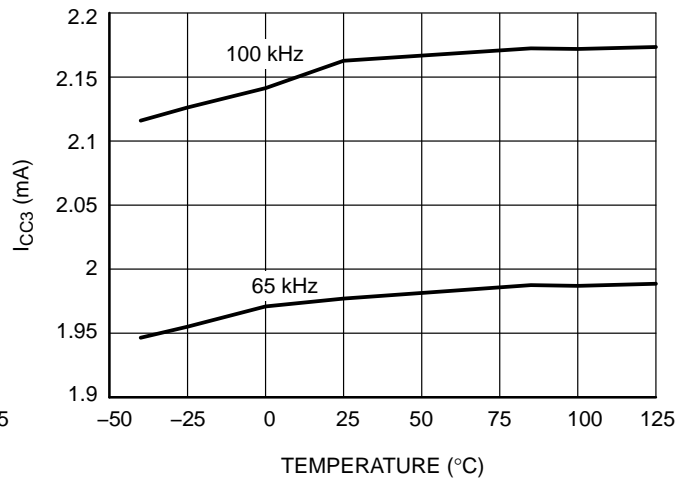

**Figure 4. NCP1124  $I_{CC3}$  vs. Junction Temperature**

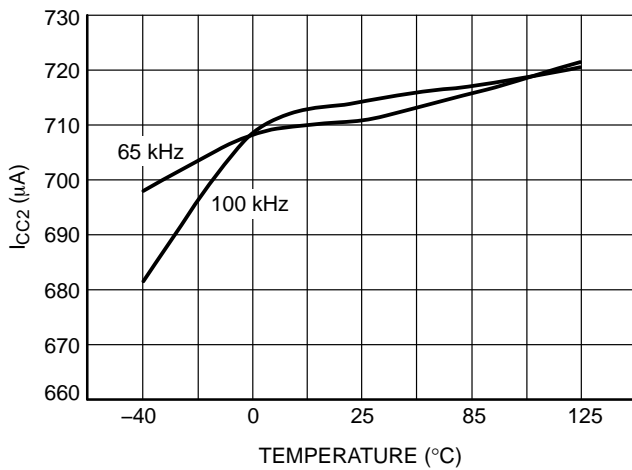

**Figure 5. NCP1126  $I_{CC2}$  vs. Junction Temperature**

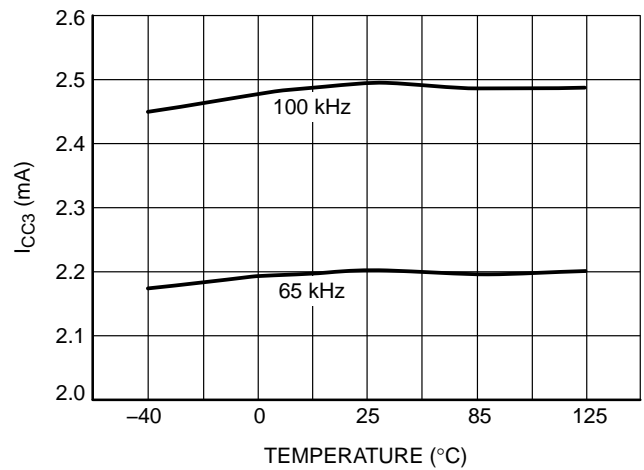

**Figure 6. NCP1126  $I_{CC3}$  vs. Junction Temperature**

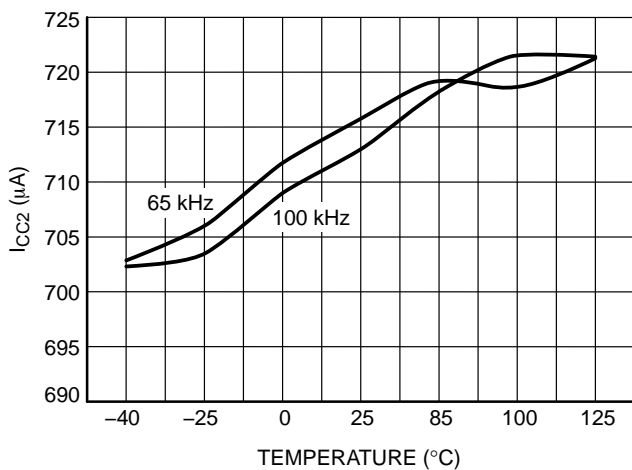

**Figure 7. NCP1129  $I_{CC2}$  vs. Junction Temperature**

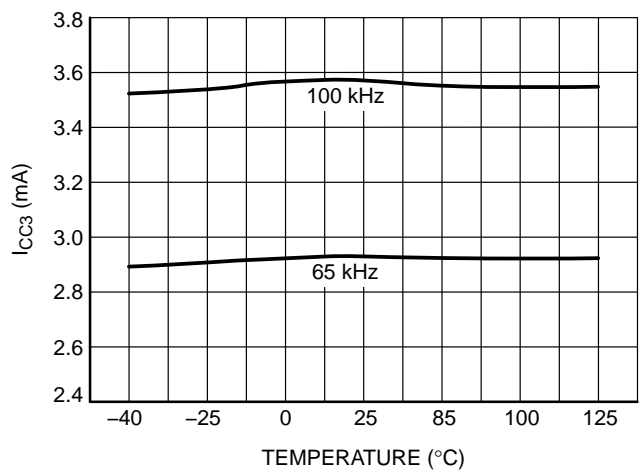

**Figure 8. NCP1129  $I_{CC3}$  vs. Junction Temperature**

# NCP1124, NCP1126, NCP1129

## TYPICAL CHARACTERISTICS

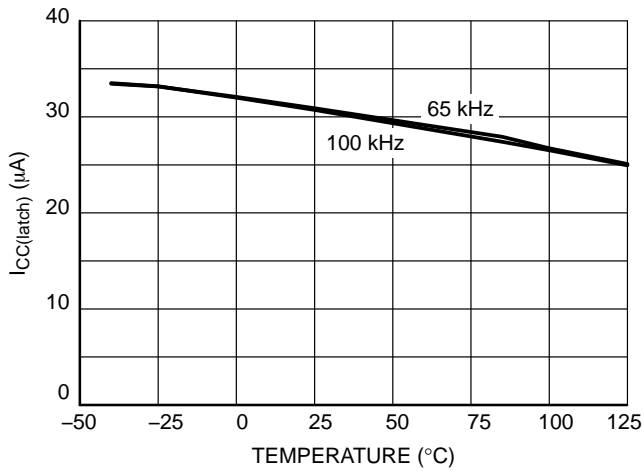

Figure 9. NCP1124  $I_{CC(latch)}$  vs. Junction Temperature

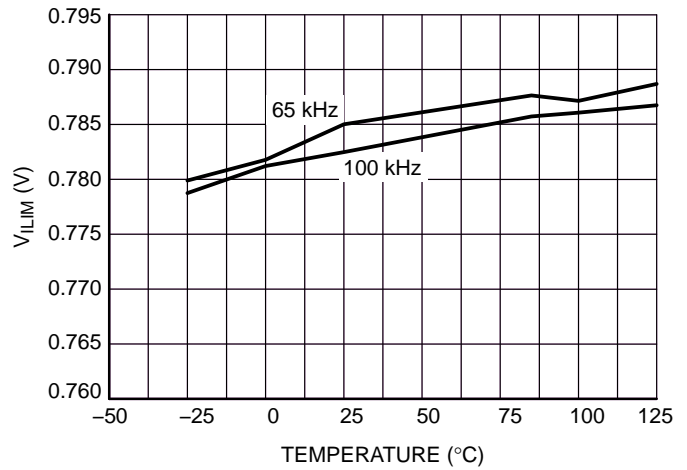

Figure 10. NCP1124  $V_{ILIM}$  vs. Junction Temperature

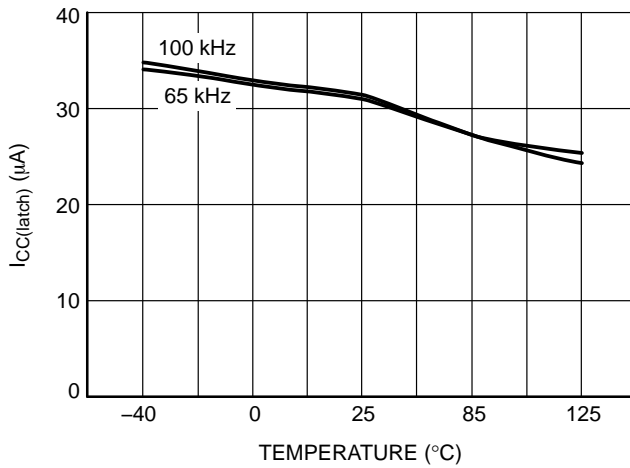

Figure 11. NCP1126  $I_{CC(latch)}$  vs. Junction Temperature

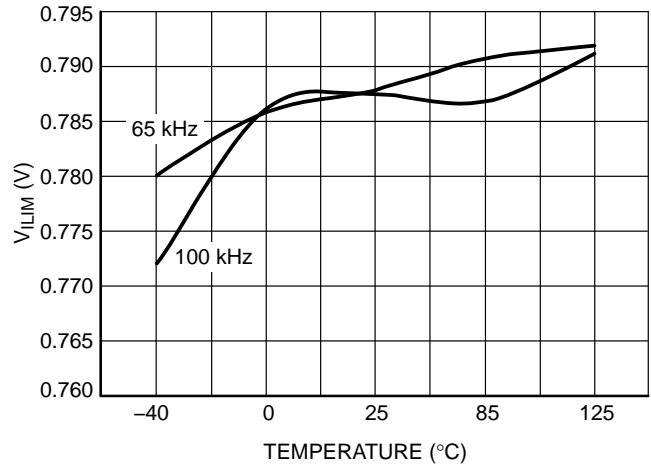

Figure 12. NCP1126  $V_{ILIM}$  vs. Junction Temperature

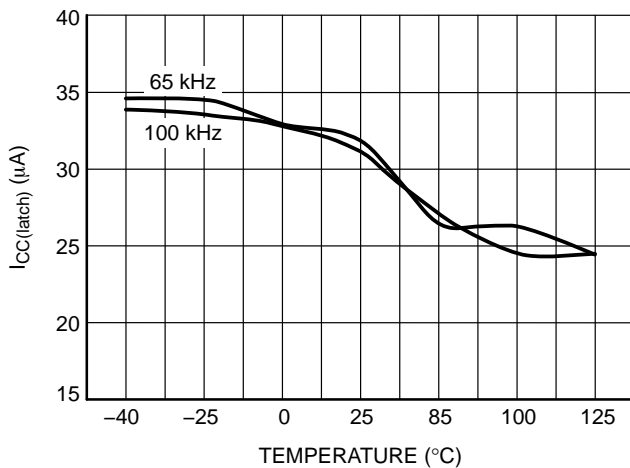

Figure 13. NCP1129  $I_{CC(latch)}$  vs. Junction Temperature

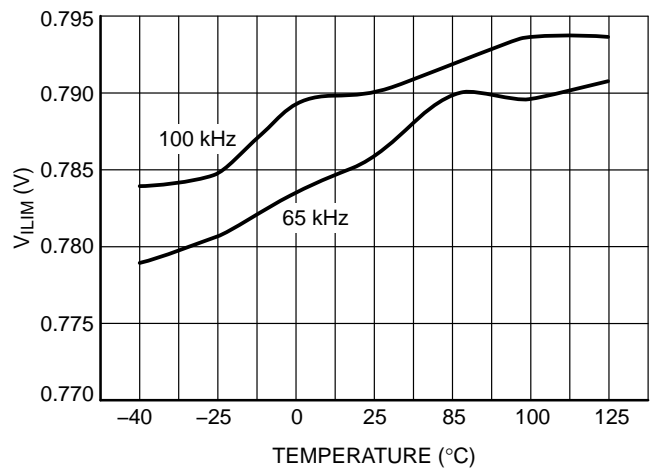
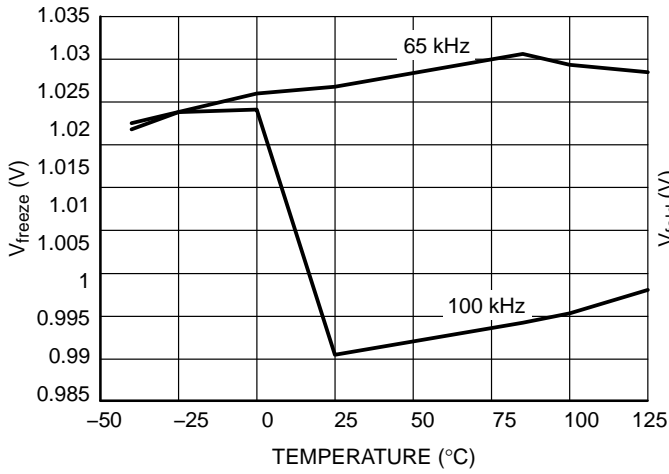

Figure 14. NCP1129  $V_{ILIM}$  vs. Junction Temperature



# NCP1124, NCP1126, NCP1129

## TYPICAL CHARACTERISTICS



**Figure 15. NCP1124  $V_{freeze}$  vs. Junction Temperature**

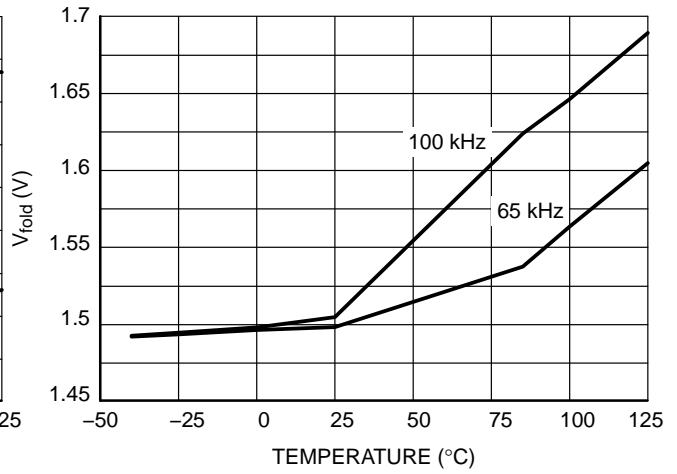

**Figure 16. NCP1124  $V_{fold}$  vs. Junction Temperature**

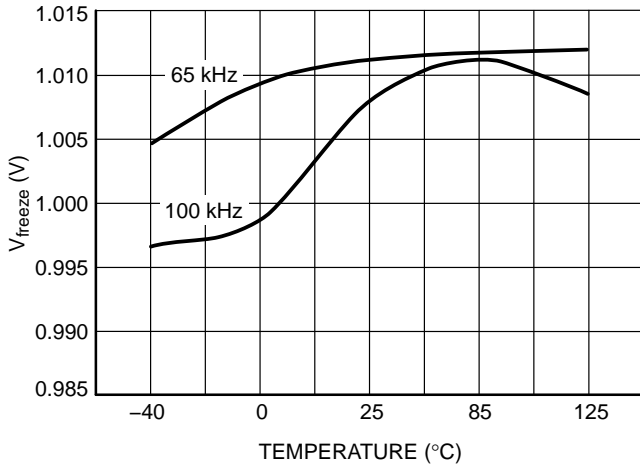

**Figure 17. NCP1126  $V_{freeze}$  vs. Junction Temperature**

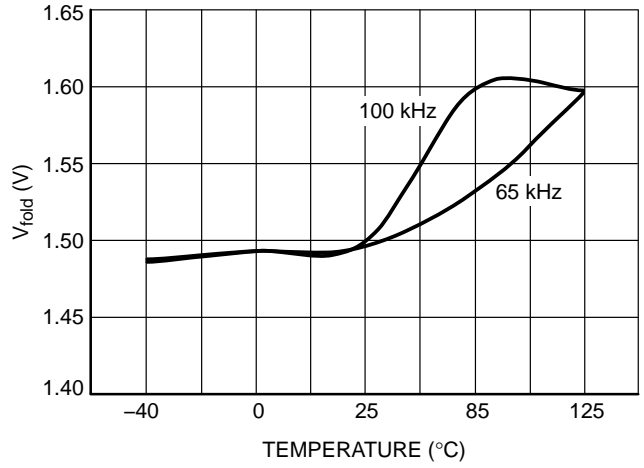

**Figure 18. NCP1126  $V_{fold}$  vs. Junction Temperature**

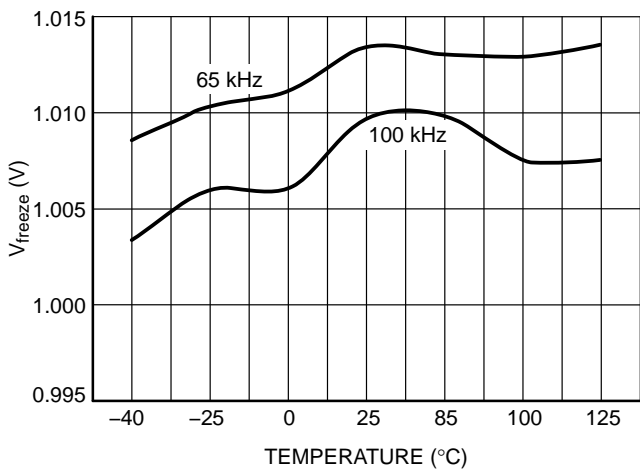

**Figure 19. NCP1129  $V_{freeze}$  vs. Junction Temperature**

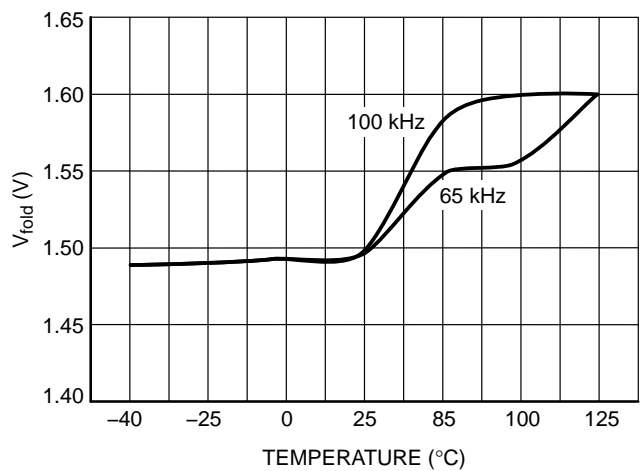

**Figure 20. NCP1129  $V_{fold}$  vs. Junction Temperature**

# NCP1124, NCP1126, NCP1129

## TYPICAL CHARACTERISTICS

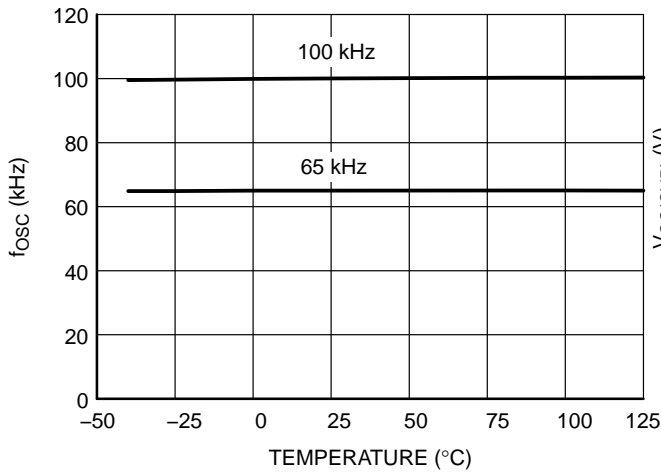

Figure 21. NCP1124  $f_{OSC}$  vs. Junction Temperature

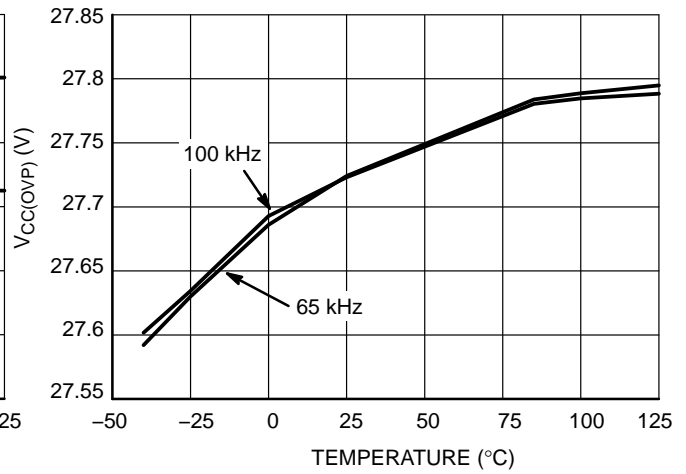

Figure 22. NCP1124  $V_{CC(OVP)}$  vs. Junction Temperature

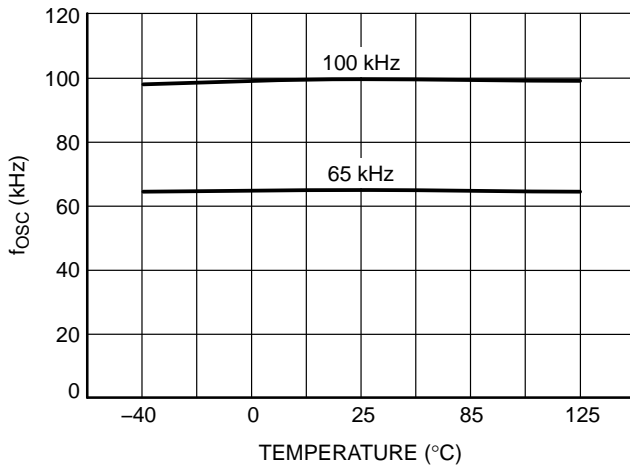

Figure 23. NCP1126  $f_{OSC}$  vs. Junction Temperature

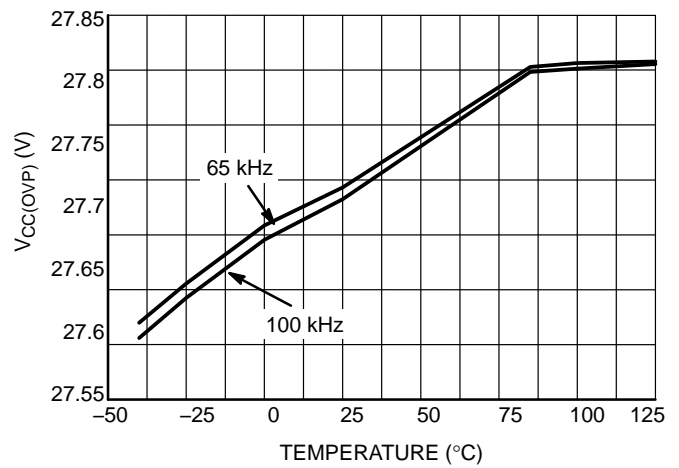

Figure 24. NCP1126  $V_{CC(OVP)}$  vs. Junction Temperature

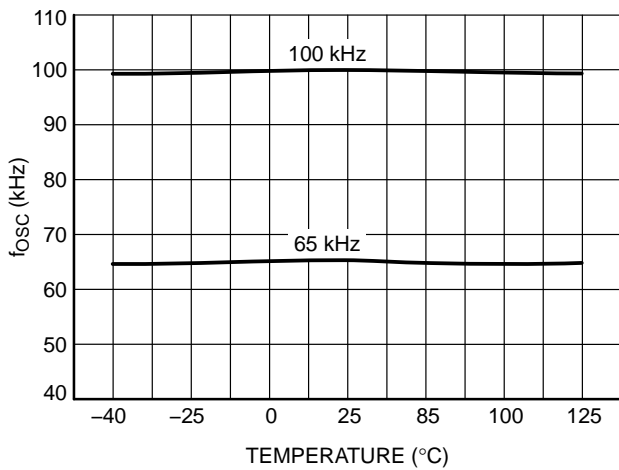

Figure 25. NCP1129  $f_{OSC}$  vs. Junction Temperature

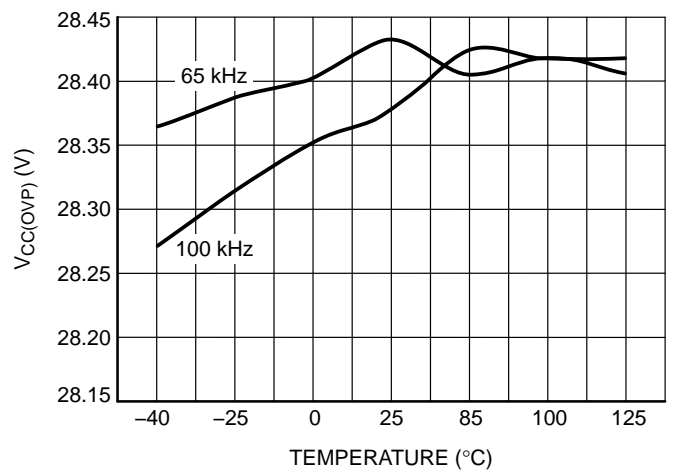

Figure 26. NCP1129  $V_{CC(OVP)}$  vs. Junction Temperature

# NCP1124, NCP1126, NCP1129

## TYPICAL CHARACTERISTICS

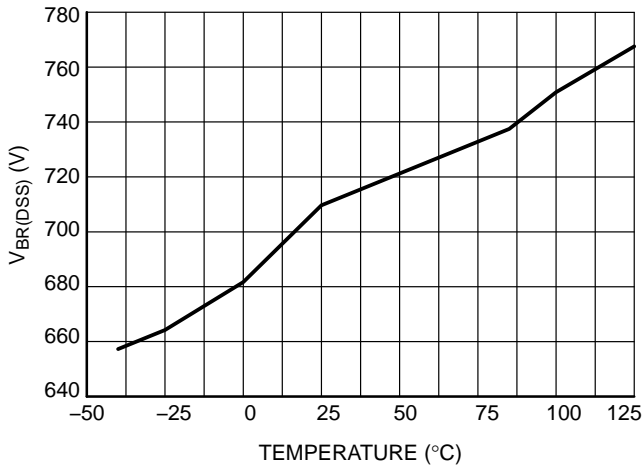

Figure 27. NCP1124  $V_{BR(DSS)}$  vs. Junction Temperature

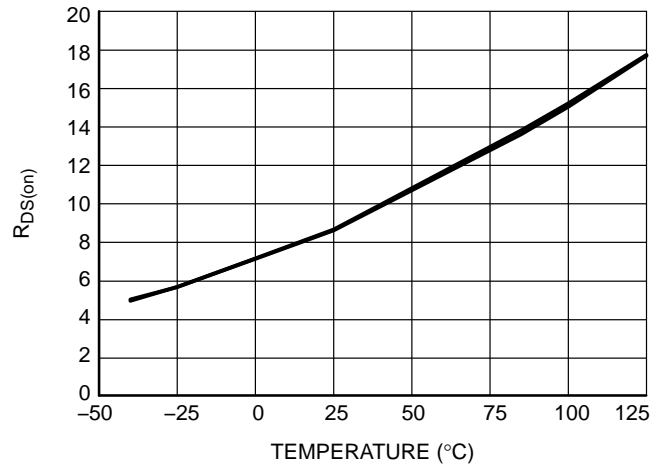

Figure 28. NCP 1124  $R_{DS(on)}$  vs. Junction Temperature

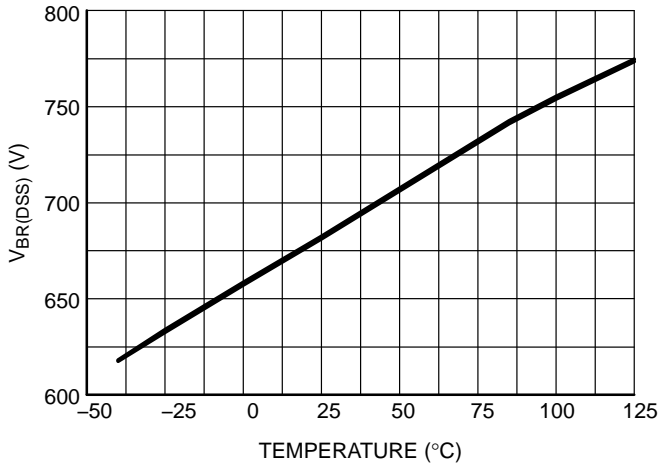

Figure 29. NCP1126  $V_{BR(DSS)}$  vs. Junction Temperature

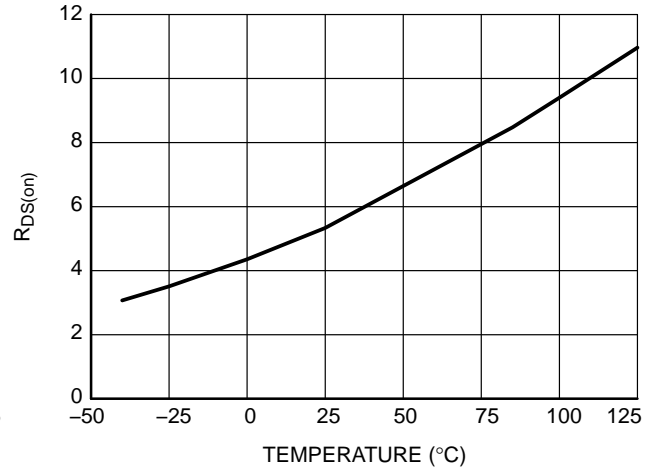

Figure 30. NCP 1126  $R_{DS(on)}$  vs. Junction Temperature

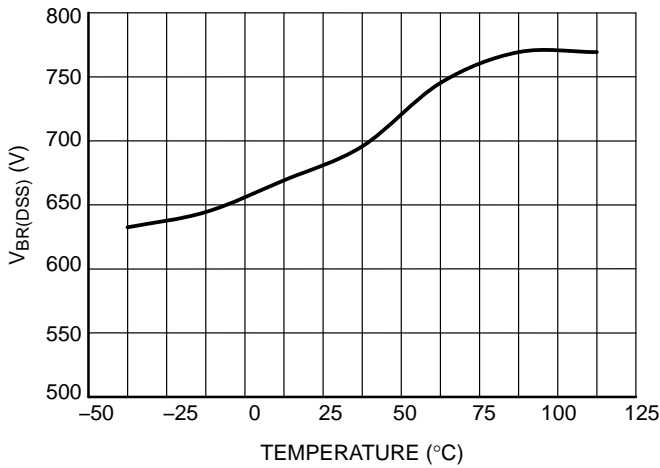

Figure 31. NCP1129  $V_{BR(DSS)}$  vs. Junction Temperature

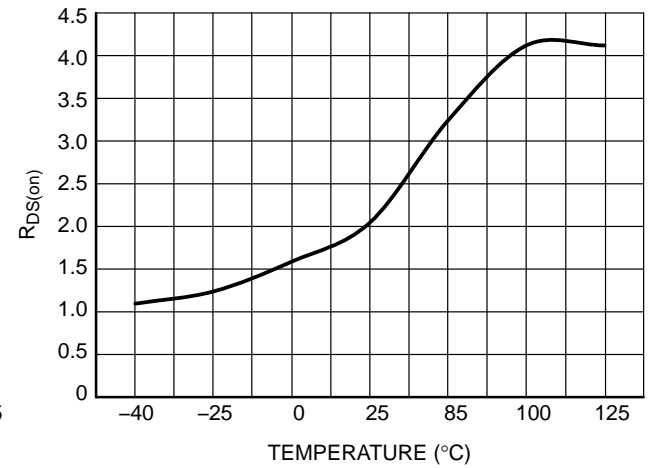
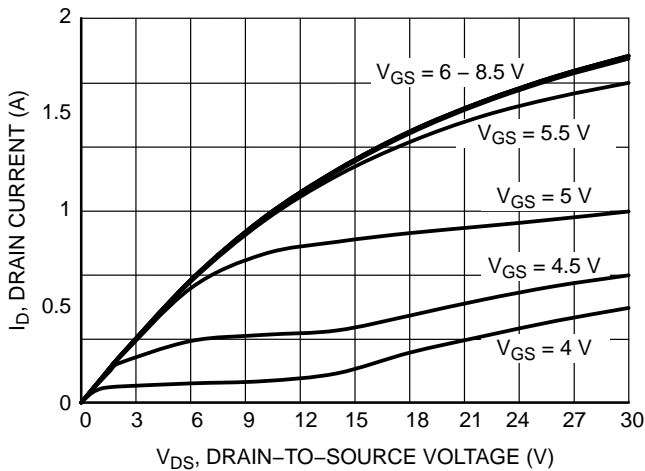

Figure 32. NCP 1129  $R_{DS(on)}$  vs. Junction Temperature

# NCP1124, NCP1126, NCP1129

## TYPICAL CHARACTERISTICS



**Figure 33. NCP1124 – Drain Current vs. Drain-to-Source Voltage**

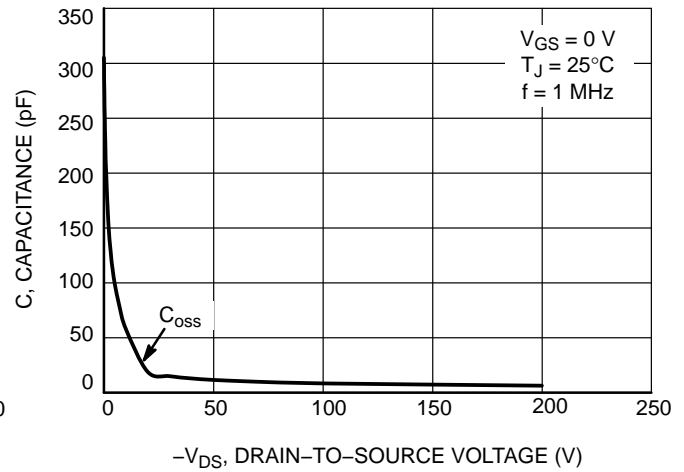

**Figure 34. NCP1124 – Capacitance Variation**

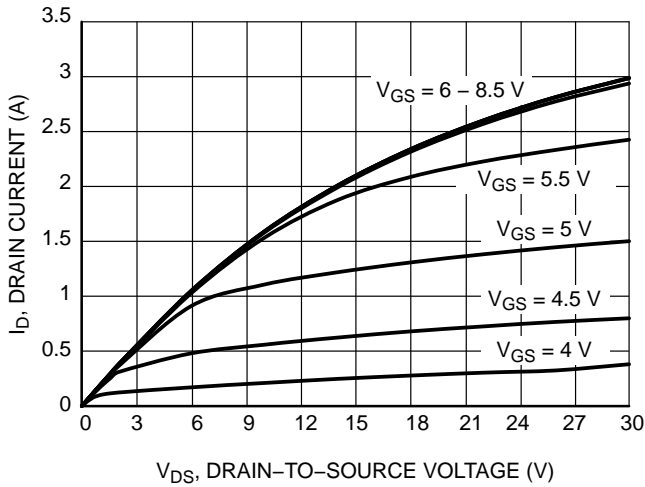

**Figure 35. NCP1126 – Drain Current vs. Drain-to-Source Voltage**

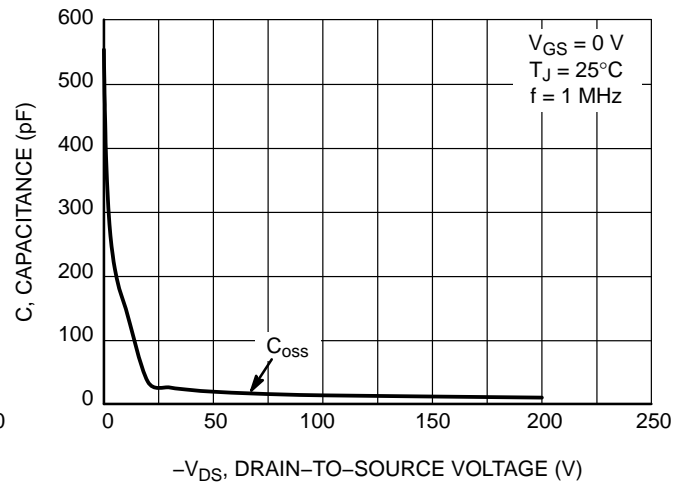

**Figure 36. NCP1126 – Capacitance Variation**

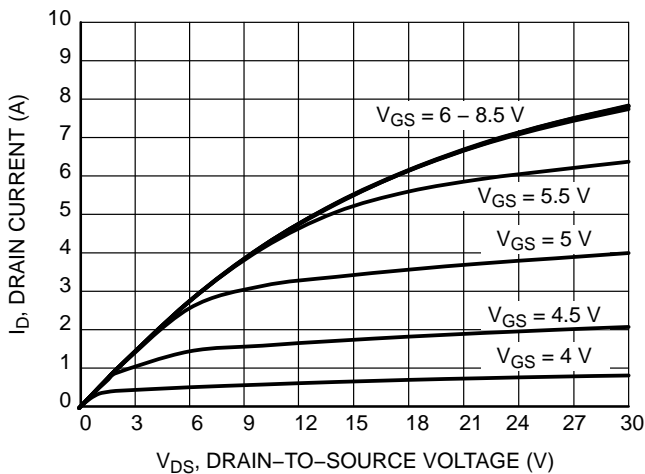

**Figure 37. NCP1129 – Drain Current vs. Drain-to-Source Voltage**

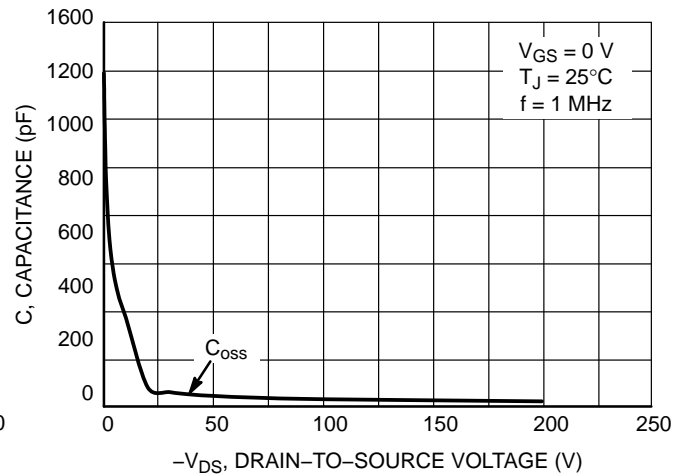

**Figure 38. NCP1129 – Capacitance Variation**

APPLICATION INFORMATION

Introduction

The NCP112x family integrates a high-performance current-mode controller with a 650 V MOSFET, which considerably simplifies the design of a compact and reliable switch mode power supply (SMPS). This component represents the ideal candidate where low part-count and cost effectiveness are the key parameters. The NCP112x brings most necessary functions needed in today's modern power supply designs, with several enhancements such as  $V_{CC}$  OVP, adjustable slope compensation, frequency jittering, frequency foldback, skip cycle, etc.

- Current-mode operation with adjustable internal ramp compensation:** Sub-harmonic oscillations in peak current mode control can be eliminated by the adjustable internal ramp compensation when the duty ratio is larger than 0.5.
- Frequency foldback capability:** When the load current drops, the controller responds by reducing the primary peak current. When the peak current reaches the skip peak current level, the NCP112x enter skip operation to reduce the power consumption.
- Internal soft-start:** a soft-start precludes the main power switch from being stressed upon start-up. In this switcher, the soft-start is internally fixed to 4 ms. Soft-start is activated when a new startup sequence occurs or during an auto-recovery hiccup.
- Latched OVP on  $V_{CC}$ :** When the  $V_{CC}$  exceeds 28 V typical, the drive signal is disabled and the part latches off. When the user cycles the  $V_{CC}$  down, the circuit is reset and the part enters a new start up sequence.
- Short-circuit protection:** short-circuit and especially over-load protections are difficult to implement when a strong leakage inductance between the auxiliary and the power windings affects the transformer (the aux winding level does not properly collapse in presence of an output short). Every time the internal 0.8 V maximum peak current limit is activated, an error flag is asserted and an internal timer starts. When the fault is validated, the switcher will either be latched or enter the auto-recovery mode. As soon as the fault disappears, the SMPS resumes operation.
- EMI jittering:** an internal low-frequency 240 Hz modulation signal varies the pace at which the oscillator frequency is modulated. This helps spread out the energy in a conducted noise analysis. To improve the EMI signature at low power levels, the jittering will not be disabled in frequency foldback mode (light load conditions).

Start-up Sequence

The NCP112x need an external startup circuit to provide the initial energy to the switcher. As is shown in Figure 39, the startup circuit consists of  $R_{start}$  and  $V_{CC}$  capacitor  $C_{CC}$ , connected to the main input, i.e. half-wave connection. The auxiliary winding will take over the RC circuit after the output voltage is built up.

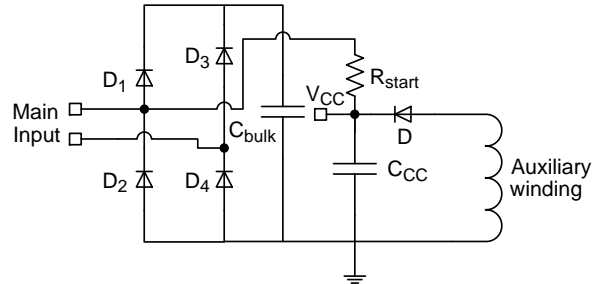

Figure 39. Startup Circuit for NCP112x (half-wave connection)

The startup process can be well explained by Figure 40. At power on, when the  $V_{CC}$  capacitor is fully discharged, the switcher current consumption is zero and does not deliver any driving pulses. The  $V_{CC}$  capacitor  $C_{CC}$  is going to be charged by the main input via  $R_{start}$ . As  $V_{CC}$  increases, the switcher consumed current remains below a guaranteed limit until the voltage on the capacitor reaches  $V_{CC(on)}$ , at which point the switcher starts to deliver pulses to the power MOSFET. The switcher current consumption suddenly increases, and the capacitor depletes since it is the only energy reservoir. Its voltage falls until the auxiliary winding takes over and supply the  $V_{CC}$  pin.

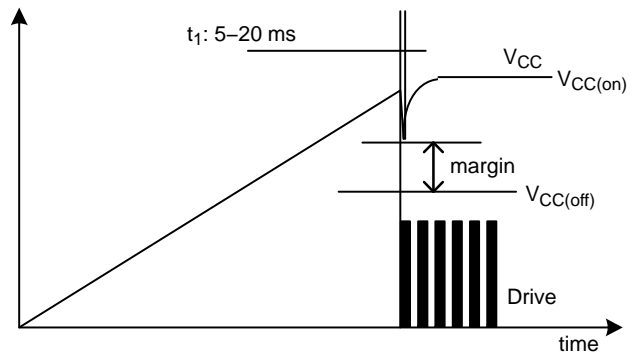

Figure 40. Startup Process for NCP112x

The start-up current of the switcher is extremely low, below 15  $\mu$ A. The start-up resistor can be connected to the bulk capacitor or directly the mains input voltage for further power dissipation reduction. The switcher begins switching when  $V_{CC}$  reaches  $V_{CC(on)}$ , typically 17 V for NCP1126/9. From Figure 41, it can be seen that the startup resistor  $R_{start}$  and  $V_{CC}$  capacitor are about to be determined.

### V<sub>CC</sub> Capacitor

The supply capacitor, C<sub>CC</sub>, provides power to the switcher during power up. The capacitor must be large enough such that a V<sub>CC</sub> voltage greater than V<sub>CC(off)</sub> is maintained while the auxiliary supply voltage is building up. Otherwise, V<sub>CC</sub> will collapse and the switcher will turn off. Assuming this time t<sub>1</sub> is equal to 10 ms, Equation 1 is used to calculate the required V<sub>CC</sub> capacitor.

$$C_{CC} \geq \frac{I_{CC}t_1}{V_{CC(on)} - V_{CC(off)}} \quad (\text{eq. 1})$$

### Startup Resistor R<sub>start</sub>

In order to determine the startup resistor, the V<sub>CC</sub> capacitor charging current is calculated first to ensure that the charging time for the V<sub>CC</sub> capacitor from 0 V to its operating voltage meets the startup time requirement. Equation 2 gives the first constraints for the R<sub>start</sub> selection.

$$I_{\text{charge}} \geq \frac{V_{CC(on)}C_{CC}}{t_{\text{startup}}} \quad (\text{eq. 2})$$

For NCP1126/9, during startup process, from 0 to t<sub>1</sub>, the current that flow inside the switcher is I<sub>CC1</sub>, therefore the total charging current from the main input is going to be I<sub>C</sub> = I<sub>charge</sub> + I<sub>CC1</sub>. Consider the half-wave connection start-up network to the mains as is shown in Figure 41, the average current flowing into this start-up resistor will be the smallest when V<sub>CC</sub> reaches the V<sub>CC(on)</sub> of the switcher:

$$I_{c,\text{min}} = \frac{\frac{V_{ac,\text{rms}}\sqrt{2}}{\pi} - V_{CC(on)}}{R_{\text{start-up}}} \quad (\text{eq. 3})$$

which gives the minimum value for the R<sub>start-up</sub>,

$$R_{\text{start-up}} \leq \frac{\frac{V_{ac,\text{rms}}\sqrt{2}}{\pi} - V_{CC(on)}}{I_{c,\text{min}}} \quad (\text{eq. 4})$$

Note that this calculation is purely theoretical, considering a constant charging current. In reality, the take over time can be shorter (or longer!) and it can lead to a reduction of the V<sub>CC</sub> capacitor. This brings a decrease in the charging current and an increase of the start-up resistor, for the benefit of standby power. The dissipated power at high line amounts to:

$$P_{\text{diss}} = \frac{V_{ac,\text{peak}}^2}{4R_{\text{start}}} \quad (\text{eq. 5})$$

The above derivation is based on the case when the power supply is not at light load. V<sub>CC</sub> capacitor selection should ensure that does not disappear in no-load conditions. In light load condition, the skip-cycle can be so deep that refreshing pulses are likely to be widely spaced, inducing a large ripple on the V<sub>CC</sub> capacitor. If this ripple is too large, chances exist to hit the V<sub>CC(off)</sub> and reset the switcher into a new start-up sequence. A solution is to grow this capacitor but it will obviously be detrimental to the start-up time. The option

offered in Figure 41 elegantly solves this potential issue by adding an extra capacitor C<sub>CC,aux</sub> on the auxiliary winding. However, this component is separated from the V<sub>CC</sub> pin by a simple diode. You therefore have the ability to grow this capacitor as you need to ensure the self-supply of the switcher without affecting the start-up time and standby power.

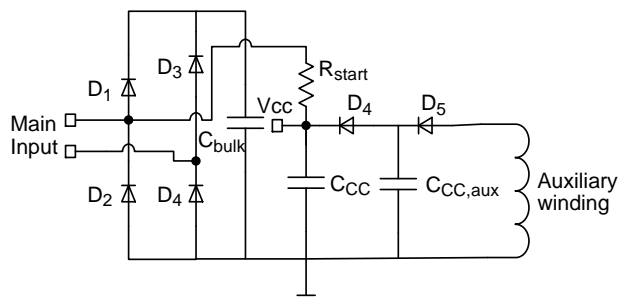

Figure 41. Startup Circuit for NCP112x (half-wave connection), Considering Light Load Condition

### Frequency Foldback

The reduction of no-load standby power associated with the need for improving the efficiency, requires a change in the traditional type of fixed-frequency operation. NCP112x implement a switching frequency foldback function when the feedback voltage is below V<sub>FB(fold)</sub>. At this point, the oscillator turns into a Voltage-Controlled Oscillator and reduces its switching frequency. The peak current setpoint follows the feedback pin until its level reaches V<sub>FB(freeze)</sub>. Below this value, the peak current freezes to V<sub>FB(freeze)</sub> / 4. The operating frequency is down to f<sub>trans</sub> when the feedback voltage reaches V<sub>FB(fold,end)</sub>. Below this point, if the output power continues to decrease, the part enters skip mode for the best noise-free performance in no-load conditions. Figure 6 depicts the adopted scheme for the part.

### Over-voltage Protection

The latched-state of the NCP112x is maintained via an internal thyristor (SCR). When the voltage on pin 1 exceeds the latch voltage for four consecutive clock cycles, the SCR is fired and immediately stops the output pulses. The same SCR is fired when an OVP is sensed on the V<sub>CC</sub> pin. When this happens, all pulses are stopped and V<sub>CC</sub> is discharged to a fix level of 7 V typically: the circuit is latched and the converter no longer delivers pulses. To maintain the latched-state, a permanent current must be injected in the part. If too low of a current, the part de-latches and the converter resumes operation. This current is characterized to 32 μA as a minimum but we recommend including a design margin and select a value around 60 μA. The test is to latch the part and reduce the input voltage until it de-latches. If you de-latch at V<sub>in</sub> = 70 V<sub>rms</sub> for a minimum voltage of 85 V<sub>rms</sub>, you are fine.

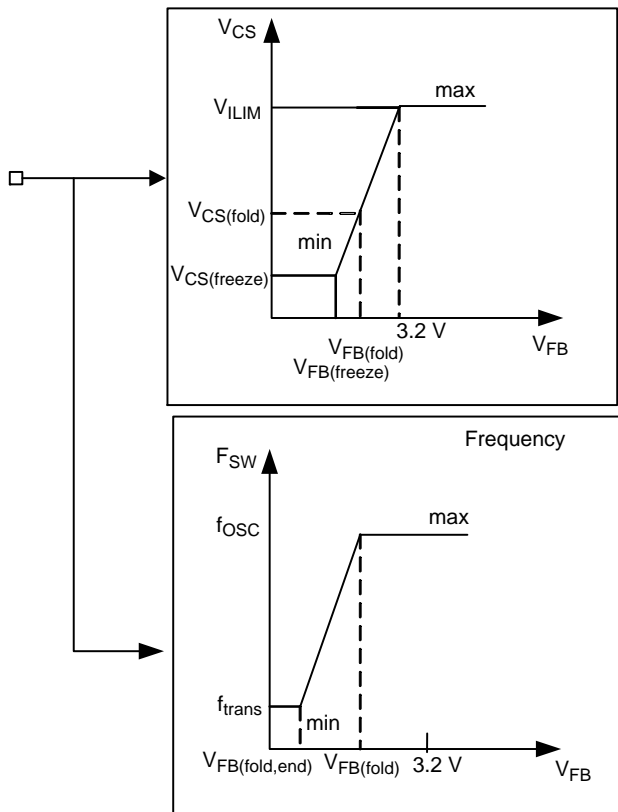

Figure 42. Frequency Foldback Architecture

If it precociously recovers, you will have to increase the start-up current, unfortunately to the detriment of standby power.

The most sensitive configuration is actually that of the half-wave connection proposed in Figure 39. As the current disappears 5 ms for a 10 ms period (50 Hz input source), the latch can potentially open at low line. If you really reduce the start-up current for a low standby power design, you must ensure enough current in the SCR in case of a faulty event. An alternate connection to the above is shown in Figure 43:

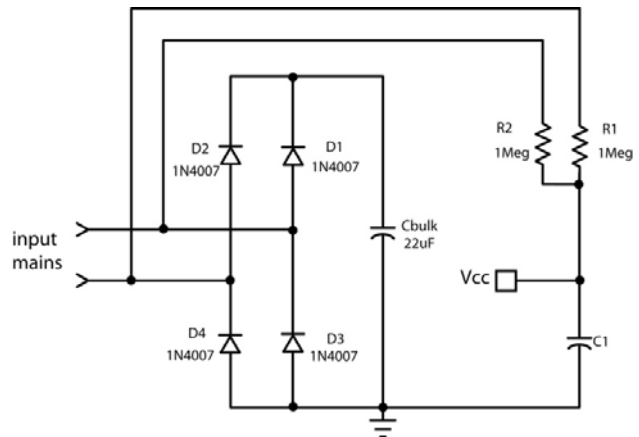

Figure 43. The Full-wave Connection Ensures Latch Current Continuity as Well as a X2-Discharge Path

In this case, the current is no longer made of 5 ms “holes” and the part can be maintained at a low input voltage. Experiments show that these 2-M $\Omega$  resistor help to maintain the latch down to less than 50 V rms, giving an excellent design margin. Standby power with this approach was also improved compared to Figure 39 solution. Please note that these resistors also ensure the discharge of the X2-capacitor up to a 0.47  $\mu$ F type.

The de-latch of the SCR occurs when a) the injected current in the  $V_{CC}$  pin falls below the minimum stated in the data-sheet (32  $\mu$ A at room temp) or when the part senses a brown-out recovery.

**Auto-Recovery Short-Circuit Protection**

In case of output short-circuit or severe overload situation, an internal error flag is raised and starts a countdown timer. If the flag is asserted longer than  $t_{OVL D}$ , the driving pulses are stopped and  $V_{CC}$  falls down as the auxiliary pulses are missing. When it hits  $V_{CC(off)}$ , the switcher consumption is down to a few  $\mu$ A and the  $V_{CC}$  slowly builds up again by the startup network  $R_{start}$ ,  $C_{CC}$ . When  $V_{CC}$  reaches  $V_{CC(on)}$ , the switcher purposely ignores the re-start and waits for another  $V_{CC}$  cycle: this is the so-called double hiccup. Illustration of such principle appears in Figure 13. Please note that soft-start is activated upon re-start attempt.

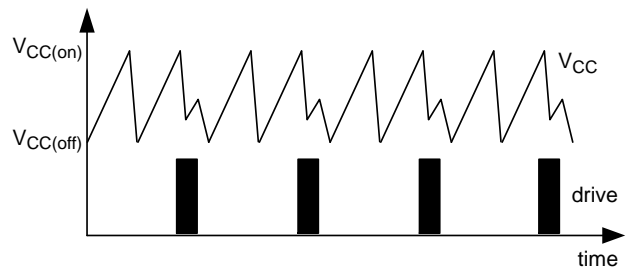
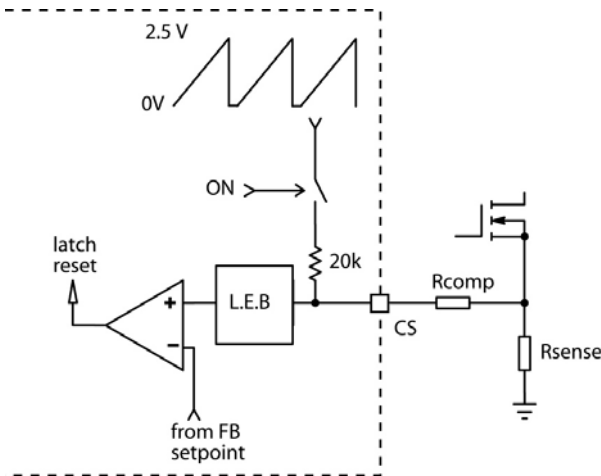

Figure 44. Auto-Recovery Double Hiccup Sequence

**Adjustable Ramp Compensation**

The NCP112x also include an internal ramp compensation signal. This is the buffered oscillator clock delivered during the on time only. Its amplitude  $V_{ramp}$  is around 2.5 V at maximum duty-cycle. Ramp compensation is a well-known method used to eliminate the sub-harmonic oscillations in CCM peak current mode converters. These oscillations take place at half the switching frequency and occur only during Continuous Conduction Mode (CCM) with a duty-ratio greater than 50%. To lower the current loop gain, one usually mixes between 50% and 100% of the inductor downslope with the current-sense signal. Figure 45 depicts how internally the ramp is generated. Note that the ramp signal will be disconnected from the CS pin, during the off-time.



**Figure 45. Internal Adjustable Ramp Compensation Architecture**

In the NCP112x switchers, the oscillator ramp exhibits a  $V_{ramp}$  2.5 V swing reached at its maximum duty-ratio. If the clock operates at a 65-kHz frequency, then the slope of the ramp is equal to:

$$S_{ramp} = \frac{V_{ramp}}{D_{max}T_{sw}} \quad (eq. 6)$$

The off-time primary current slope  $S_p$  is thus given by Equation 7:

$$S_p = \frac{(V_{out} + V_f) \frac{N_p}{N_s}}{L_p} \quad (eq. 7)$$

Given a sense resistor  $R_{sense}$  the above current ramp turns into a voltage ramp of the following amplitude:

$$S_{sense} = S_p R_{sense} \quad (eq. 8)$$

The slope of compensation ramp is chosen to be the same as the downslope of the sensing ramp for better transient response. The internal resistor connected to the compensation ramp is 20 kΩ. The series compensation resistor value is therefore:

$$R_{comp} = R_{ramp} \frac{S_{sense}}{S_{ramp}} \quad (eq. 9)$$

A resistor of the above value will then be inserted from the sense resistor to the current sense pin. A 100 pF capacitor is recommended to be added to the current sense pin to the switcher ground for improved noise immunity with the current sensing components located very close to the switcher.



## NCP1124, NCP1126, NCP1129

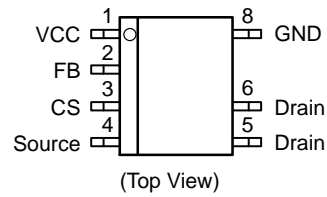

**Figure 46. Pin Connections**

### ORDERING INFORMATION

Device	Package	Shipping
NCP1124AP65G	PDIP-7 (Pb-Free)	50 Units / Rail
NCP1124BP65G	PDIP-7 (Pb-Free)	50 Units / Rail
NCP1124AP100G	PDIP-7 (Pb-Free)	50 Units / Rail
NCP1124BP100G	PDIP-7 (Pb-Free)	50 Units / Rail
NCP1126AP65G	PDIP-7 (Pb-Free)	50 Units / Rail
NCP1126BP65G	PDIP-7 (Pb-Free)	50 Units / Rail
NCP1126AP100G	PDIP-7 (Pb-Free)	50 Units / Rail
NCP1126BP100G	PDIP-7 (Pb-Free)	50 Units / Rail
NCP1129AP65G	PDIP-7 (Pb-Free)	50 Units / Rail
NCP1129BP65G	PDIP-7 (Pb-Free)	50 Units / Rail
NCP1129AP100G	PDIP-7 (Pb-Free)	50 Units / Rail
NCP1129BP100G	PDIP-7 (Pb-Free)	50 Units / Rail

# MECHANICAL CASE OUTLINE

## PACKAGE DIMENSIONS

ON Semiconductor®



SCALE 1:1

### PDIP-7 (PDIP-8 LESS PIN 7) CASE 626B ISSUE D

DATE 22 APR 2015

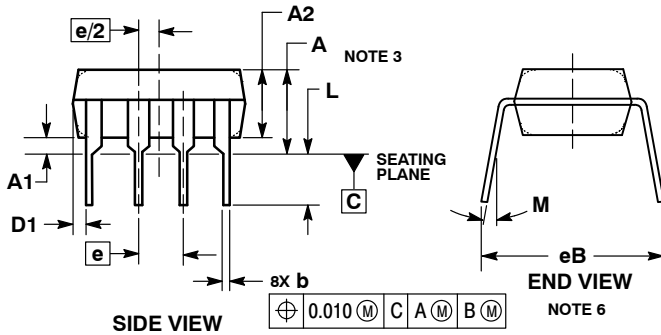
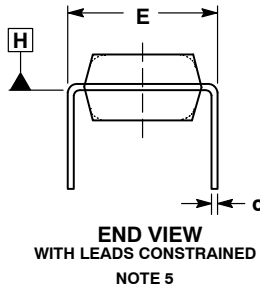
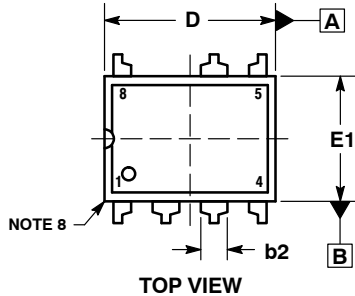

NOTES:

- DIMENSIONING AND TOLERANCING PER ASME Y14.5M, 1994.
- CONTROLLING DIMENSION: INCHES.
- DIMENSIONS A, A1 AND L ARE MEASURED WITH THE PACKAGE SEATED IN JEDEC SEATING PLANE GAUGE GS-3.
- DIMENSIONS D, D1 AND E1 DO NOT INCLUDE MOLD FLASH OR PROTRUSIONS. MOLD FLASH OR PROTRUSIONS ARE NOT TO EXCEED 0.10 INCH.
- DIMENSION E IS MEASURED AT A POINT 0.015 BELOW DATUM PLANE H WITH THE LEADS CONSTRAINED PERPENDICULAR TO DATUM C.
- DIMENSION eB IS MEASURED AT THE LEAD TIPS WITH THE LEADS UNCONSTRAINED.
- DATUM PLANE H IS COINCIDENT WITH THE BOTTOM OF THE LEADS, WHERE THE LEADS EXIT THE BODY.
- PACKAGE CONTOUR IS OPTIONAL (ROUNDED OR SQUARE CORNERS).

DIM	INCHES		MILLIMETERS	
	MIN	MAX	MIN	MAX
A	----	0.210	----	5.33
A1	0.015	----	0.38	----
A2	0.115	0.195	2.92	4.95
b	0.014	0.022	0.35	0.56
b2	0.060 TYP		1.52 TYP	
C	0.008	0.014	0.20	0.36
D	0.355	0.400	9.02	10.16
D1	0.005	----	0.13	----
E	0.300	0.325	7.62	8.26
E1	0.240	0.280	6.10	7.11
e	0.100 BSC			
eB	----	0.430	----	10.92
L	0.115	0.150	2.92	3.81
M	----	10°	----	10°

### GENERIC MARKING DIAGRAM\*

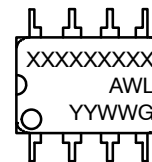

- XXXX = Specific Device Code
- A = Assembly Location
- WL = Wafer Lot
- YY = Year
- WW = Work Week
- G = Pb-Free Package

\*This information is generic. Please refer to device data sheet for actual part marking. Pb-Free indicator, "G" or microdot "•", may or may not be present.

STYLE 1:

- PIN 1. AC IN
- 2. DC + IN
- 3. DC - IN
- 4. AC IN
- 5. GROUND
- 6. OUTPUT
- 7. NOT USED
- 8. V<sub>CC</sub>

⊕	0.010	M	C	A	M	B	M
---	-------	---	---	---	---	---	---

<b>DOCUMENT NUMBER:</b>	<b>98AON12198D</b>	Electronic versions are uncontrolled except when accessed directly from the Document Repository. Printed versions are uncontrolled except when stamped "CONTROLLED COPY" in red.
<b>DESCRIPTION:</b>	<b>PDIP-7 (PDIP-8 LESS PIN 7)</b>	<b>PAGE 1 OF 1</b>

ON Semiconductor and are trademarks of Semiconductor Components Industries, LLC dba ON Semiconductor or its subsidiaries in the United States and/or other countries. ON Semiconductor reserves the right to make changes without further notice to any products herein. ON Semiconductor makes no warranty, representation or guarantee regarding the suitability of its products for any particular purpose, nor does ON Semiconductor assume any liability arising out of the application or use of any product or circuit, and specifically disclaims any and all liability, including without limitation special, consequential or incidental damages. ON Semiconductor does not convey any license under its patent rights nor the rights of others.

**onsemi**, **Onsemi**, and other names, marks, and brands are registered and/or common law trademarks of Semiconductor Components Industries, LLC dba "**onsemi**" or its affiliates and/or subsidiaries in the United States and/or other countries. **onsemi** owns the rights to a number of patents, trademarks, copyrights, trade secrets, and other intellectual property. A listing of **onsemi**'s product/patent coverage may be accessed at [www.onsemi.com/site/pdf/Patent-Marking.pdf](http://www.onsemi.com/site/pdf/Patent-Marking.pdf). **onsemi** reserves the right to make changes at any time to any products or information herein, without notice. The information herein is provided "as-is" and **onsemi** makes no warranty, representation or guarantee regarding the accuracy of the information, product features, availability, functionality, or suitability of its products for any particular purpose, nor does **onsemi** assume any liability arising out of the application or use of any product or circuit, and specifically disclaims any and all liability, including without limitation special, consequential or incidental damages. Buyer is responsible for its products and applications using **onsemi** products, including compliance with all laws, regulations and safety requirements or standards, regardless of any support or applications information provided by **onsemi**. "Typical" parameters which may be provided in **onsemi** data sheets and/or specifications can and do vary in different applications and actual performance may vary over time. All operating parameters, including "Typicals" must be validated for each customer application by customer's technical experts. **onsemi** does not convey any license under any of its intellectual property rights nor the rights of others. **onsemi** products are not designed, intended, or authorized for use as a critical component in life support systems or any FDA Class 3 medical devices or medical devices with a same or similar classification in a foreign jurisdiction or any devices intended for implantation in the human body. Should Buyer purchase or use **onsemi** products for any such unintended or unauthorized application, Buyer shall indemnify and hold **onsemi** and its officers, employees, subsidiaries, affiliates, and distributors harmless against all claims, costs, damages, and expenses, and reasonable attorney fees arising out of, directly or indirectly, any claim of personal injury or death associated with such unintended or unauthorized use, even if such claim alleges that **onsemi** was negligent regarding the design or manufacture of the part. **onsemi** is an Equal Opportunity/Affirmative Action Employer. This literature is subject to all applicable copyright laws and is not for resale in any manner.

## PUBLICATION ORDERING INFORMATION

### LITERATURE FULFILLMENT:

Email Requests to: [orderlit@onsemi.com](mailto:orderlit@onsemi.com)

**onsemi Website:** [www.onsemi.com](http://www.onsemi.com)

### TECHNICAL SUPPORT

**North American Technical Support:**

Voice Mail: 1 800-282-9855 Toll Free USA/Canada

Phone: 011 421 33 790 2910

**Europe, Middle East and Africa Technical Support:**

Phone: 00421 33 790 2910

For additional information, please contact your local Sales Representative