

THIS DOCUMENT IS THE PROPERTY OF KEYSTONE ELECTRONICS CORP. AND SHALL NOT BE REPRODUCED, DISTRIBUTED OR USED AS A BASIS FOR MANUFACTURE WITHOUT PRIOR WRITTEN PERMISSION FROM KEYSTONE ELECTRONICS CORP.

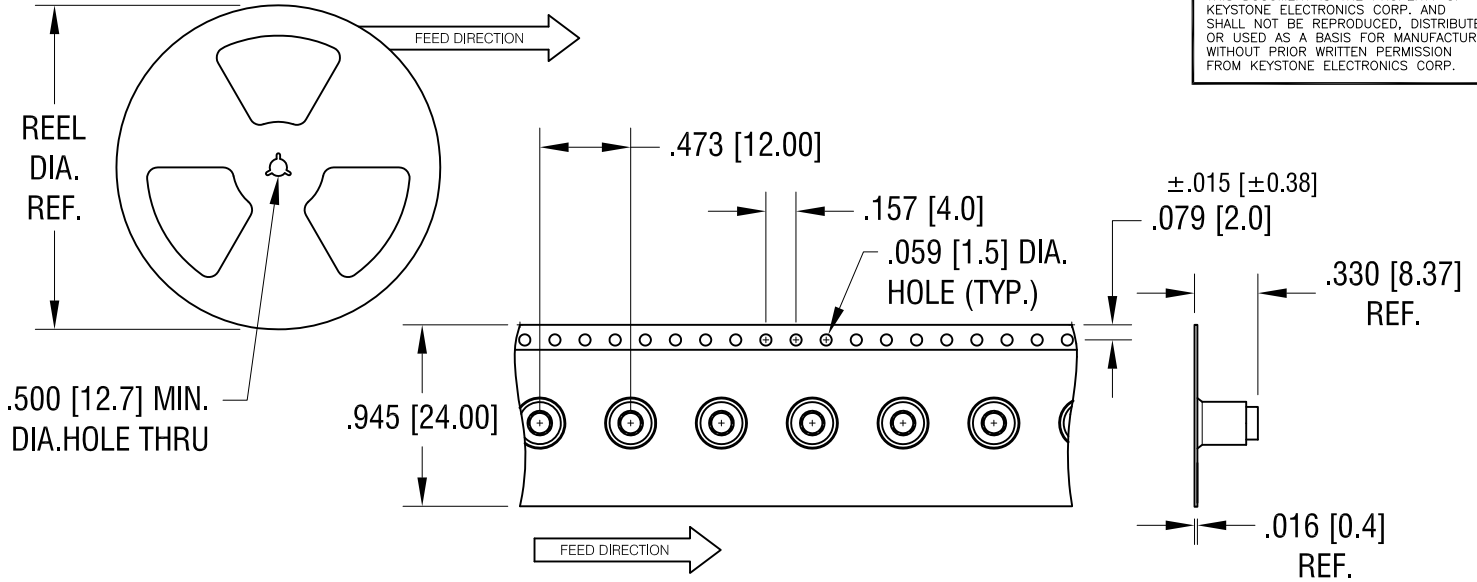

MOUNTING DETAIL

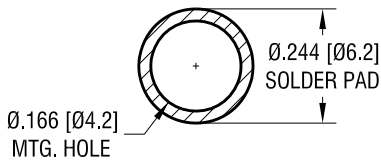

ACTUAL SIZE

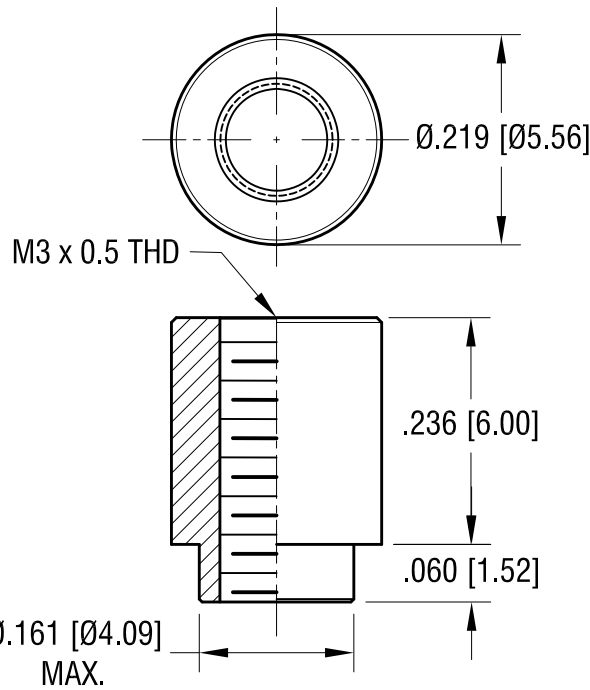

NOTES:

1. SUPPLIED ON TAPE AND REEL ONLY.
TAPE AND REEL SPECIFICATIONS:
2. TAPE:
MAT'L - ALL CONDUCTIVE POLYSTYRENE CARRIER
ANSI/EIA-481 STANDARD
3. REEL:
13" [330.2] DIA. 650 PIECES PER REEL
4. KAPTON TAPE ADDED TO TOP SURFACE OF STANDOFF

KEYSTONE ELECTRONICS CORP.

www.keyelco.com • NEW HYDE PARK, NY 11040 • Tel (516) 328-7500

PART NAME		SM STANDOFF	
MATERIAL		STEEL	
FINISH	DRN BY	DATE	
MATTE TIN PLATE	NT	11.16.16	
	APP'D	SCALE	
	RH	5X, 1X	
TOLERANCES	INCH	[MM]	CODE
DECIMAL	± .005	[± 0.13]	C
ANGULAR	± 1°		
UNLESS OTHERWISE SPECIFIED			DWG NO.
			24884

DATE	DESCRIPTION	REV.