

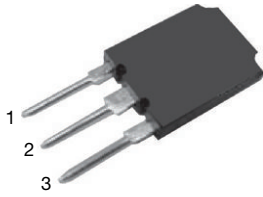

Thyristor High Voltage, Phase Control SCR, 70 A

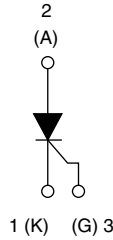

Super TO-247



FEATURES

- High surge capability
- High voltage input rectification
- Designed and qualified according to JEDEC®-JESD 47
- Material categorization: for definitions of compliance please see www.vishay.com/doc?99912



RoHS COMPLIANT

| PRIMARY CHARACTERISTICS | |
|-------------------------|-------------------|
| $I_{T(AV)}$ | 70 A |
| V_{DRM}/V_{RRM} | 1200 V, 1600 V |
| V_{TM} | 1.25 V |
| I_{GT} | 100 mA |
| T_J | -40 °C to +125 °C |
| Package | Super TO-247 |
| Circuit configuration | Single SCR |

APPLICATIONS

- AC switches
- High voltage input rectification (soft start)
- High current crow-bar
- Other phase-control circuits
- Designed to be used with Vishay input diodes, switches, and output rectifiers which are available in identical package outlines

DESCRIPTION

The VS-70TPS.. PbF high voltage series of silicon controlled rectifiers are specifically designed for high and medium power switching, and phase control applications.

| MAJOR RATINGS AND CHARACTERISTICS | | | |
|-----------------------------------|-----------------------------|--------------|------------|
| PARAMETER | TEST CONDITIONS | VALUES | UNITS |
| $I_{T(AV)}$ | Sinusoidal waveform | 70 | A |
| I_{RMS} | Lead current limitation | 75 | |
| V_{RRM}/V_{DRM} | Range | 1200 to 1600 | V |
| I_{TSM} | | 1100 | A |
| V_T | 100 A, $T_J = 25\text{ °C}$ | 1.4 | V |
| dV/dt | | 500 | V/ μ s |
| dI/dt | | 150 | A/ μ s |
| T_J | | -40 to +125 | °C |

| VOLTAGE RATINGS | | | |
|-----------------|--|--|-----------------------------------|
| PART NUMBER | V_{RRM}/V_{DRM} , MAXIMUM REPETITIVE PEAK AND OFF-STATE VOLTAGE V | V_{RSM} , MAXIMUM NON-REPETITIVE PEAK REVERSE VOLTAGE V | I_{RRM}/I_{DRM} AT 125 °C mA |
| VS-70TPS12PbF | 1200 | 1300 | 15 |
| VS-70TPS16PbF | 1600 | 1700 | |



VS-70TPS12PbF, VS-70TPS16PbF High Voltage Series

www.vishay.com

Vishay Semiconductors

| ABSOLUTE MAXIMUM RATINGS | | | | | |
|--|-------------------|---|--|--------|-------------------|
| PARAMETER | SYMBOL | TEST CONDITIONS | | VALUES | UNITS |
| Maximum average on-state current | $I_{T(AV)}$ | $T_C = 82\text{ }^\circ\text{C}$, 180° conduction half sine wave | | 70 | A |
| Maximum continuous RMS on-state current as AC switch | $I_{T(RMS)}$ | Lead current limitation | | 75 | |
| Maximum peak, one-cycle non-repetitive surge current | I_{TSM} | 10 ms sine pulse, rated V_{RRM} applied | | 930 | A ² s |
| | | 10 ms sine pulse, no voltage reapplied | | 1100 | |
| Maximum I^2t for fusing | I^2t | 10 ms sine pulse, rated V_{RRM} applied | | 4325 | |
| | | 10 ms sine pulse, no voltage reapplied | | 6115 | |
| Maximum $I^2\sqrt{t}$ for fusing | $I^2\sqrt{t}$ | $t = 0.1\text{ ms to } 10\text{ ms}$, no voltage reapplied | | 61 150 | A ² √s |
| Low level value of threshold voltage | $V_{T(TO)1}$ | $T_J = 125\text{ }^\circ\text{C}$ | | 0.916 | V |
| High level value of threshold voltage | $V_{T(TO)2}$ | | | 1.21 | |
| Low level value of on-state slope resistance | r_{t1} | | | 4.138 | mΩ |
| High level value of on-state slope resistance | r_{t2} | | | 3.43 | |
| Maximum peak on-state voltage | V_{TM} | 100 A, $T_J = 25\text{ }^\circ\text{C}$ | | 1.4 | V |
| Maximum rate of rise of turned-on current | di/dt | $T_J = 25\text{ }^\circ\text{C}$ | | 150 | A/μs |
| Maximum holding current | I_H | Anode supply = 6 V, resistive load, initial $I_T = 1\text{ A}$, $T_J = 25\text{ }^\circ\text{C}$ | | 200 | mA |
| Maximum latching current | I_L | Anode supply = 6 V, resistive load, $T_J = 25\text{ }^\circ\text{C}$ | | 400 | |
| Maximum reverse and direct leakage current | I_{RRM}/I_{DRM} | $T_J = 25\text{ }^\circ\text{C}$ | | 1.0 | |
| | | $T_J = 125\text{ }^\circ\text{C}$ | | 15 | |
| Maximum rate of rise of off-state voltage | dV/dt | $T_J = 125\text{ }^\circ\text{C}$ | | 500 | V/μs |

| TRIGGERING | | | | | |
|---|-------------|--|--|--------|-------|
| PARAMETER | SYMBOL | TEST CONDITIONS | | VALUES | UNITS |
| Maximum peak gate power | P_{GM} | $T = 30\text{ }\mu\text{s}$ | | 10 | W |
| Maximum average gate power | $P_{G(AV)}$ | | | 2.5 | |
| Maximum peak gate current | I_{GM} | | | 2.5 | A |
| Maximum peak negative gate voltage | $-V_{GM}$ | | | 10 | V |
| Maximum required DC gate voltage to trigger | V_{GT} | $T_J = -40\text{ }^\circ\text{C}$ | | 1.8 | |
| | | $T_J = 25\text{ }^\circ\text{C}$ | | 1.5 | |
| | | $T_J = 125\text{ }^\circ\text{C}$ | | 1.1 | |
| Maximum required DC gate current to trigger | I_{GT} | $T_J = -40\text{ }^\circ\text{C}$ | | 150 | mA |
| | | $T_J = 25\text{ }^\circ\text{C}$ | | 100 | |
| | | $T_J = 125\text{ }^\circ\text{C}$ | | 80 | |
| Maximum DC gate voltage not to trigger | V_{GD} | $T_J = 125\text{ }^\circ\text{C}$, $V_{DRM} = \text{rated value}$ | | 0.25 | V |
| Maximum DC gate current not to trigger | I_{GD} | | | 6 | mA |



| THERMAL AND MECHANICAL SPECIFICATIONS | | | | |
|---|------------|--------------------------------------|-------------|------------------------|
| PARAMETER | SYMBOL | TEST CONDITIONS | VALUES | UNITS |
| Maximum junction temperature range | T_J | | -40 to +125 | °C |
| Maximum storage temperature range | T_{Stg} | | -40 to +150 | |
| Maximum thermal resistance, junction to case | R_{thJC} | DC operation | 0.27 | °C/W |
| Maximum thermal resistance, junction to ambient | R_{thJA} | | 40 | |
| Typical thermal resistance, case to heatsink | R_{thCS} | Mounting surface, smooth and greased | 0.2 | |
| Approximate weight | | | 6 | g |
| | | | 0.21 | oz. |
| Mounting torque | minimum | | 6 (5) | kgf · cm (lbf · in) |
| | maximum | | 12 (10) | |
| Marking device | | Case style Super TO-247 | 70TPS12 | |
| | | | 70TPS16 | |

| ΔR_{thJ-hs} CONDUCTION PER JUNCTION | | | | | | | | | | | |
|---|---------------------------|-------|-------|-------|-------|-----------------------------|-------|-------|-------|-------|-------|
| DEVICE | SINE HALF WAVE CONDUCTION | | | | | RECTANGULAR WAVE CONDUCTION | | | | | UNITS |
| | 180° | 120° | 90° | 60° | 30° | 180° | 120° | 90° | 60° | 30° | |
| VS-70TPS..PbF | 0.078 | 0.092 | 0.117 | 0.172 | 0.302 | 0.053 | 0.092 | 0.125 | 0.180 | 0.306 | °C/W |

Note

- The table above shows the increment of thermal resistance R_{thJ-hs} when devices operate at different conduction angles than DC

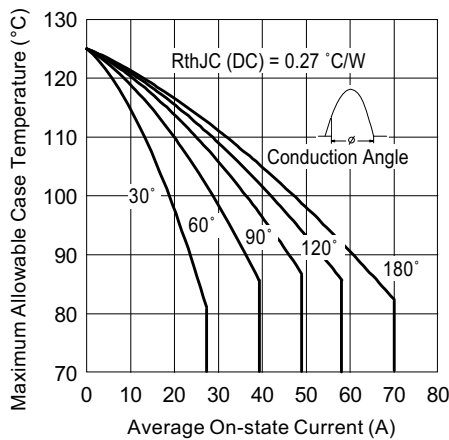

Fig. 1 - Current Rating Characteristics

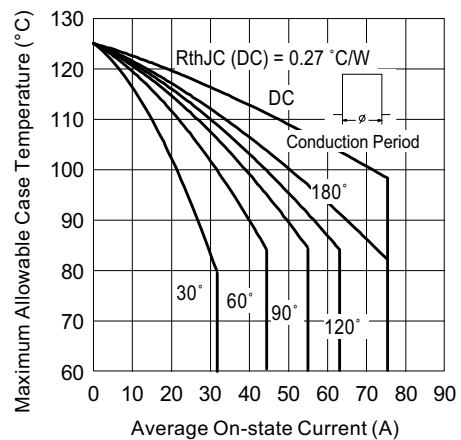

Fig. 2 - Current Rating Characteristics

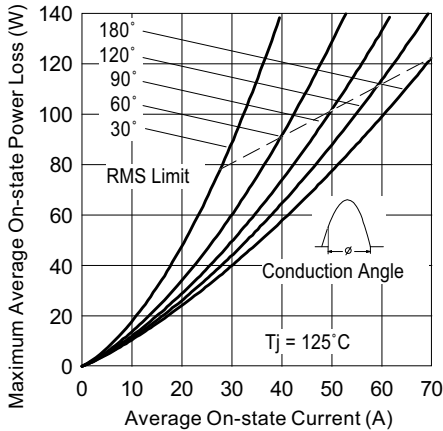

Fig. 3 - On-State Power Loss Characteristics

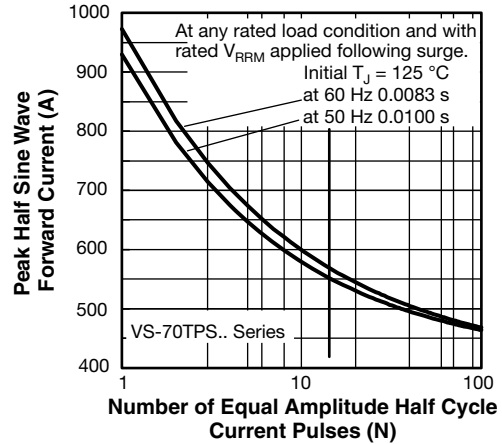

Fig. 5 - Maximum Non-Repetitive Surge Current

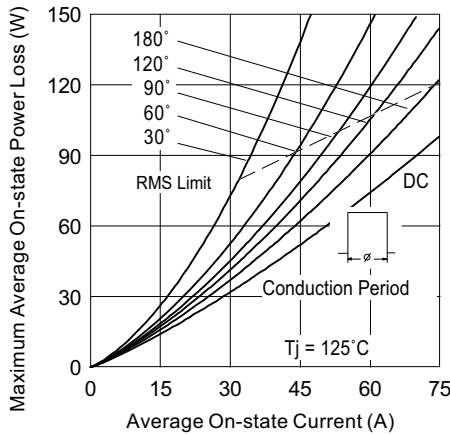

Fig. 4 - On-State Power Loss Characteristics

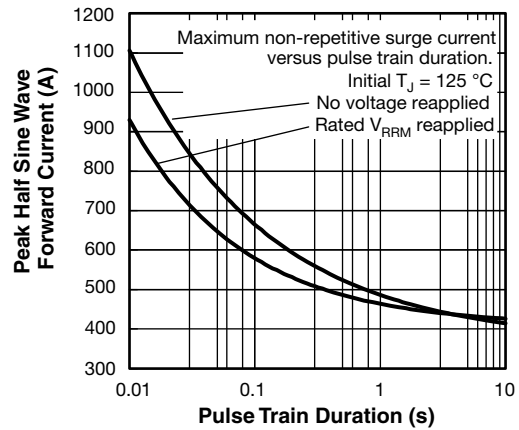

Fig. 6 - Maximum Non-Repetitive Surge Current

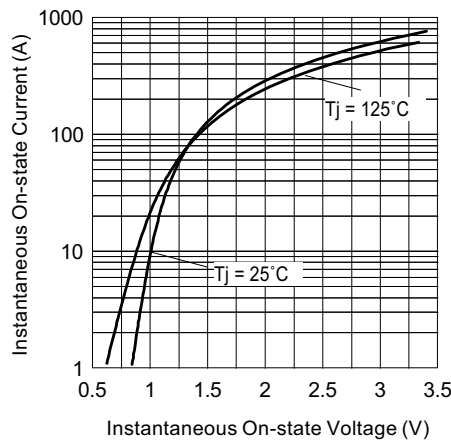

Fig. 7 - On-State Voltage Drop Characteristics

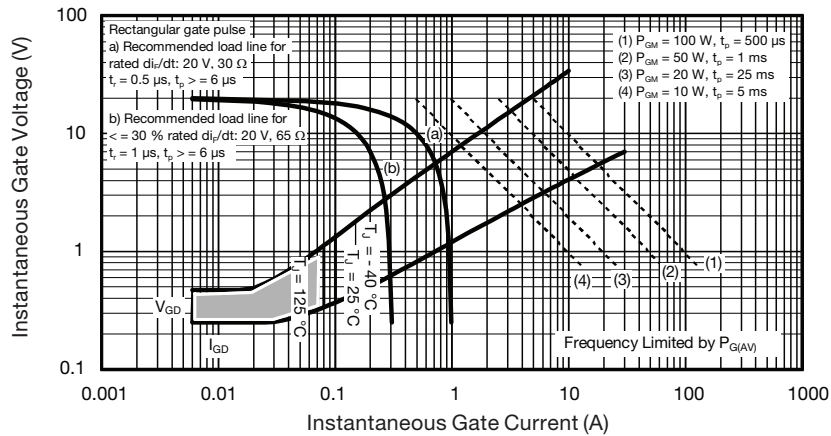

Fig. 8 - Gate Characteristics

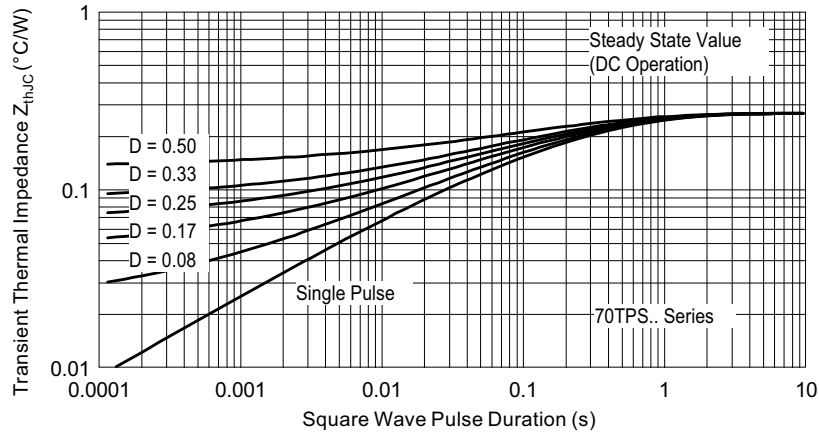
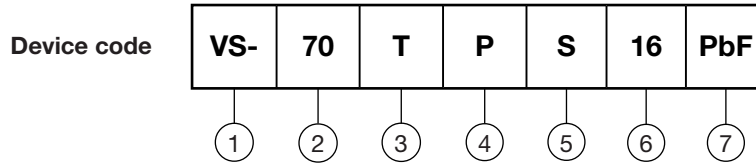

Fig. 9 - Thermal Impedance Z_{thJC} Characteristics



ORDERING INFORMATION TABLE



- 1** - Vishay Semiconductors product
- 2** - Current rating (70 = 70 A)
- 3** - Circuit configuration:
T = thyristor
- 4** - Package:
P = super TO-247
- 5** - Type of silicon:
S = standard recovery rectifier
- 6** - Voltage code x 100 = V_{RRM}

| |
|-------------|
| 12 = 1200 V |
| 16 = 1600 V |
- 7** - PbF = lead (Pb)-free

| ORDERING INFORMATION (example) | | | |
|--------------------------------|------------------|------------------------|-------------------------|
| PREFERRED P/N | QUANTITY PER T/R | MINIMUM ORDER QUANTITY | PACKAGING DESCRIPTION |
| VS-70TPS12PbF | 25 | 500 | Antistatic plastic tube |
| VS-70TPS16PbF | 25 | 500 | Antistatic plastic tube |

| LINKS TO RELATED DOCUMENTS | |
|----------------------------|--|
| Dimensions | www.vishay.com/doc?95073 |
| Part marking information | www.vishay.com/doc?95070 |
| SPICE model VS-70TPS12 | www.vishay.com/doc?96760 |
| SPICE model VS-70TPS16 | www.vishay.com/doc?96761 |

Super TO-247

DIMENSIONS in millimeters (inches)

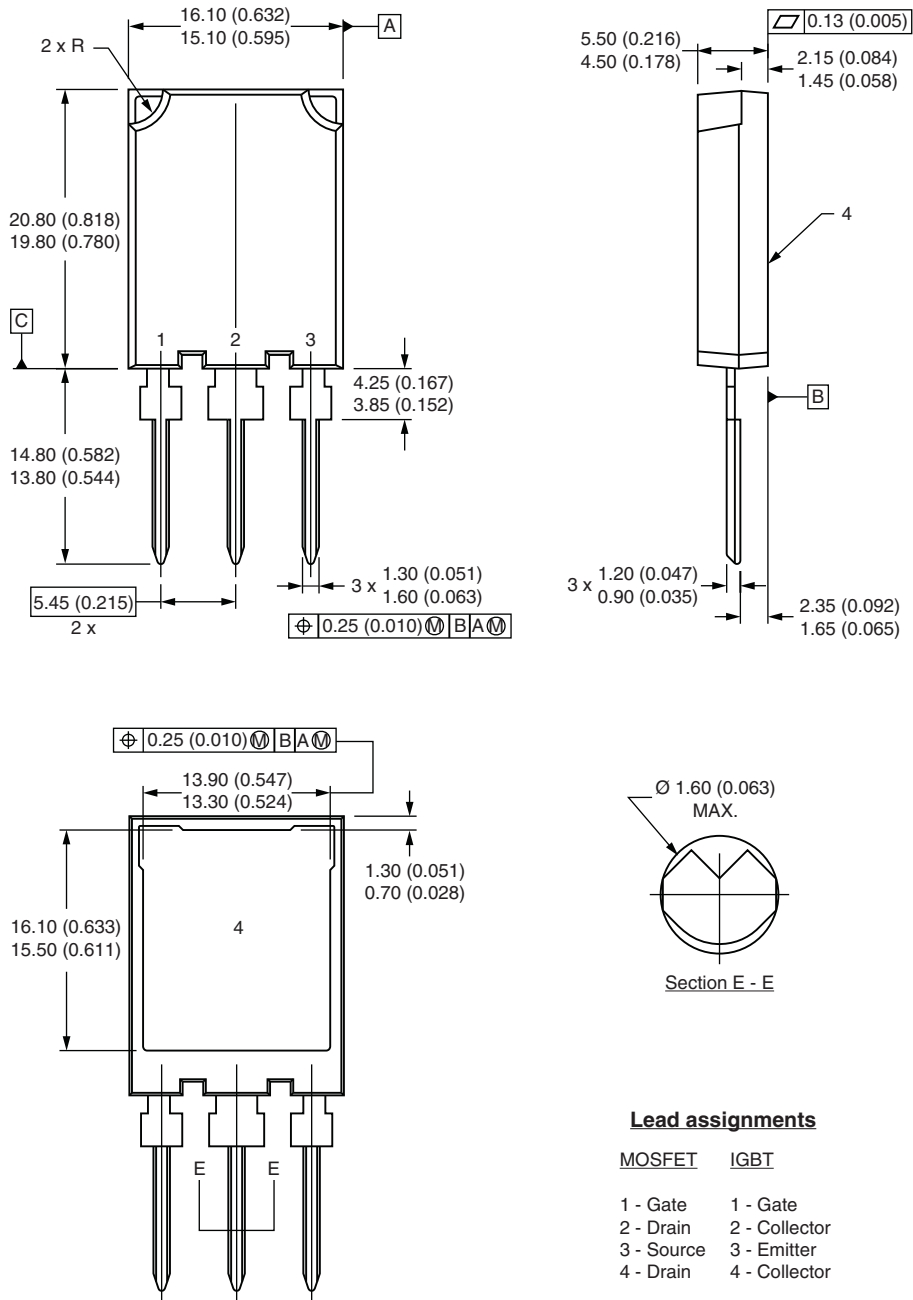

Notes

- (1) Dimension and tolerancing per ASME Y14.5M-1994
- (2) Controlling dimension: millimeter
- (3) Outline conforms to JEDEC® outline TO-274AA



Disclaimer

ALL PRODUCT, PRODUCT SPECIFICATIONS AND DATA ARE SUBJECT TO CHANGE WITHOUT NOTICE TO IMPROVE RELIABILITY, FUNCTION OR DESIGN OR OTHERWISE.

Vishay Intertechnology, Inc., its affiliates, agents, and employees, and all persons acting on its or their behalf (collectively, "Vishay"), disclaim any and all liability for any errors, inaccuracies or incompleteness contained in any datasheet or in any other disclosure relating to any product.

Vishay makes no warranty, representation or guarantee regarding the suitability of the products for any particular purpose or the continuing production of any product. To the maximum extent permitted by applicable law, Vishay disclaims (i) any and all liability arising out of the application or use of any product, (ii) any and all liability, including without limitation special, consequential or incidental damages, and (iii) any and all implied warranties, including warranties of fitness for particular purpose, non-infringement and merchantability.

Statements regarding the suitability of products for certain types of applications are based on Vishay's knowledge of typical requirements that are often placed on Vishay products in generic applications. Such statements are not binding statements about the suitability of products for a particular application. It is the customer's responsibility to validate that a particular product with the properties described in the product specification is suitable for use in a particular application. Parameters provided in datasheets and / or specifications may vary in different applications and performance may vary over time. All operating parameters, including typical parameters, must be validated for each customer application by the customer's technical experts. Product specifications do not expand or otherwise modify Vishay's terms and conditions of purchase, including but not limited to the warranty expressed therein.

Hyperlinks included in this datasheet may direct users to third-party websites. These links are provided as a convenience and for informational purposes only. Inclusion of these hyperlinks does not constitute an endorsement or an approval by Vishay of any of the products, services or opinions of the corporation, organization or individual associated with the third-party website. Vishay disclaims any and all liability and bears no responsibility for the accuracy, legality or content of the third-party website or for that of subsequent links.

Except as expressly indicated in writing, Vishay products are not designed for use in medical, life-saving, or life-sustaining applications or for any other application in which the failure of the Vishay product could result in personal injury or death. Customers using or selling Vishay products not expressly indicated for use in such applications do so at their own risk. Please contact authorized Vishay personnel to obtain written terms and conditions regarding products designed for such applications.

No license, express or implied, by estoppel or otherwise, to any intellectual property rights is granted by this document or by any conduct of Vishay. Product names and markings noted herein may be trademarks of their respective owners.