

# ON Semiconductor

## Is Now

The logo for onsemi, featuring the word "onsemi" in a dark teal, lowercase, sans-serif font. The letter "i" is stylized with a white dot and a teal vertical bar. A small orange triangle is positioned above the top right of the "i". A trademark symbol (TM) is located to the right of the logo.

To learn more about onsemi™, please visit our website at  
[www.onsemi.com](http://www.onsemi.com)

---

**onsemi** and **onsemi** and other names, marks, and brands are registered and/or common law trademarks of Semiconductor Components Industries, LLC dba "**onsemi**" or its affiliates and/or subsidiaries in the United States and/or other countries. **onsemi** owns the rights to a number of patents, trademarks, copyrights, trade secrets, and other intellectual property. A listing of **onsemi** product/patent coverage may be accessed at [www.onsemi.com/site/pdf/Patent-Marking.pdf](http://www.onsemi.com/site/pdf/Patent-Marking.pdf). **onsemi** reserves the right to make changes at any time to any products or information herein, without notice. The information herein is provided "as-is" and **onsemi** makes no warranty, representation or guarantee regarding the accuracy of the information, product features, availability, functionality, or suitability of its products for any particular purpose, nor does **onsemi** assume any liability arising out of the application or use of any product or circuit, and specifically disclaims any and all liability, including without limitation special, consequential or incidental damages. Buyer is responsible for its products and applications using **onsemi** products, including compliance with all laws, regulations and safety requirements or standards, regardless of any support or applications information provided by **onsemi**. "Typical" parameters which may be provided in **onsemi** data sheets and/or specifications can and do vary in different applications and actual performance may vary over time. All operating parameters, including "Typicals" must be validated for each customer application by customer's technical experts. **onsemi** does not convey any license under any of its intellectual property rights nor the rights of others. **onsemi** products are not designed, intended, or authorized for use as a critical component in life support systems or any FDA Class 3 medical devices or medical devices with a same or similar classification in a foreign jurisdiction or any devices intended for implantation in the human body. Should Buyer purchase or use **onsemi** products for any such unintended or unauthorized application, Buyer shall indemnify and hold **onsemi** and its officers, employees, subsidiaries, affiliates, and distributors harmless against all claims, costs, damages, and expenses, and reasonable attorney fees arising out of, directly or indirectly, any claim of personal injury or death associated with such unintended or unauthorized use, even if such claim alleges that **onsemi** was negligent regarding the design or manufacture of the part. **onsemi** is an Equal Opportunity/Affirmative Action Employer. This literature is subject to all applicable copyright laws and is not for resale in any manner. Other names and brands may be claimed as the property of others.

# MOSFET - Power, Single P-Channel, SO8-FL -30 V, 2.7 mΩ, -164 A



ON Semiconductor®

[www.onsemi.com](http://www.onsemi.com)

## NTMFS005P03P8Z

### Features

- Ultra Low  $R_{DS(on)}$  to Improve System Efficiency
- Advanced Package Technology in 5x6mm for Space Saving and Excellent Thermal Conduction
- These Devices are Pb-Free, Halogen Free/BFR Free and are RoHS Compliant

### Typical Applications

- Power Load Switch
- Protection: Reverse Current, Over Voltage, and Reverse Negative Voltage
- Battery Management

### MAXIMUM RATINGS ( $T_J = 25^\circ\text{C}$ unless otherwise noted)

Parameter	Symbol	Value	Unit		
Drain-to-Source Voltage	$V_{DSS}$	-30	V		
Gate-to-Source Voltage	$V_{GS}$	$\pm 25$	V		
Continuous Drain Current $R_{\theta JC}$ (Note 3)	Steady State	$T_C = 25^\circ\text{C}$	$I_D$	-164	A
		$T_C = 85^\circ\text{C}$		-118	
		$T_C = 25^\circ\text{C}$	$P_D$	104	W
Power Dissipation $R_{\theta JA}$ (Note 3)	Steady State	$T_A = 25^\circ\text{C}$	$I_D$	-28.6	A
		$T_A = 85^\circ\text{C}$		-20.6	
		$T_A = 25^\circ\text{C}$	$P_D$	3.2	W
Continuous Drain Current $R_{\theta JA}$ (Notes 1, 3)	Steady State	$T_A = 25^\circ\text{C}$	$I_D$	-15.3	A
		$T_A = 85^\circ\text{C}$		-11	
		$T_A = 25^\circ\text{C}$	$P_D$	0.9	W
Power Dissipation $R_{\theta JA}$ (Notes 2, 3)					
Pulsed Drain Current	$T_A = 25^\circ\text{C}, t_p = 10 \mu\text{s}$	$I_{DM}$	-597	A	
Single Pulse Drain-to-Source Avalanche Energy ( $I_{Lpk} = 57.59 \text{ A}$ )	$E_{AS}$	165.8	mJ		
Operating Junction and Storage Temperature Range	$T_J, T_{stg}$	-55 to +150	$^\circ\text{C}$		
Lead Temperature for Soldering Purposes (1/8" from case for 10 s)	$T_L$	260	$^\circ\text{C}$		

Stresses exceeding those listed in the Maximum Ratings table may damage the device. If any of these limits are exceeded, device functionality should not be assumed, damage may occur and reliability may be affected.

1. Surface-mounted on FR4 board using a 1 in<sup>2</sup> pad size, 2 oz. Cu pad.
2. Surface-mounted on FR4 board using a minimum pad size, 2 oz. Cu pad.
3. The entire application environment impacts the thermal resistance values shown, they are not constants and are only valid for the particular conditions noted.

$V_{(BR)DSS}$	$R_{DS(on)}$	$I_D$
-30 V	2.7 mΩ @ -10 V	-164 A
	4.4 mΩ @ -4.5 V	

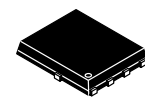
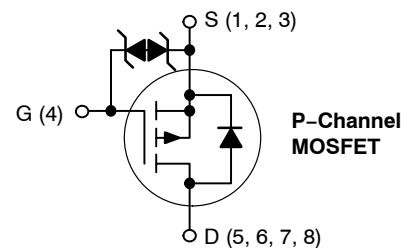

SO-8 FLAT LEAD  
CASE 488AA  
STYLE 1

### MARKING DIAGRAM

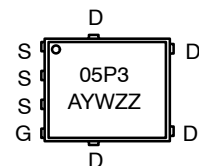

A = Assembly Location  
Y = Year  
W = Work Week  
ZZ = Lot Traceability

### ORDERING INFORMATION

Device	Package	Shipping†
NTMFS005P03P8ZT1G	SO8-FL (Pb-Free)	1500 / Tape & Reel

†For information on tape and reel specifications, including part orientation and tape sizes, please refer to our Tape and Reel Packaging Specification Brochure, BRD8011/D.

# NTMFS005P03P8Z

## THERMAL RESISTANCE MAXIMUM RATINGS

Parameter	Symbol	Value	Unit
Junction-to-Case – Steady State (Drain) (Note 1)	$R_{\theta JC}$	1.2	$^{\circ}C/W$
Junction-to-Ambient – Steady State (Note 1)	$R_{\theta JA}$	40	$^{\circ}C/W$
Junction-to-Ambient – Steady State (Note 2)	$R_{\theta JA}$	137	$^{\circ}C/W$

## ELECTRICAL CHARACTERISTICS ( $T_J = 25^{\circ}C$ unless otherwise noted)

Parameter	Symbol	Test Condition	Min	Typ	Max	Unit
-----------	--------	----------------	-----	-----	-----	------

### OFF CHARACTERISTICS

Drain-to-Source Breakdown Voltage	$V_{(BR)DSS}$	$V_{GS} = 0 V, I_D = -250 \mu A$	-30			V
Drain-to-Source Breakdown Voltage Temperature Coefficient	$V_{(BR)DSS}/T_J$	$I_D = -250 \mu A, \text{ref to } 25^{\circ}C$		-8.3		$mV/^{\circ}C$
Zero Gate Voltage Drain Current	$I_{DSS}$	$V_{GS} = 0 V, V_{DS} = -24 V, T_J = 25^{\circ}C$			-1.0	$\mu A$
Gate-to-Source Leakage Current	$I_{GSS}$	$V_{DS} = 0 V, V_{GS} = \pm 25 V$			$\pm 10$	$\mu A$

### ON CHARACTERISTICS (Note 4)

Gate Threshold Voltage	$V_{GS(TH)}$	$V_{GS} = V_{DS}, I_D = -250 \mu A$	-1.0		-3.0	V
Threshold Temperature Coefficient	$V_{GS(TH)}/T_J$	$I_D = -250 \mu A, \text{ref to } 25^{\circ}C$		5.3		$mV/^{\circ}C$
Drain-to-Source On Resistance	$R_{DS(on)}$	$V_{GS} = -10 V, I_D = -22 A$		1.8	2.7	$m\Omega$
		$V_{GS} = -4.5 V, I_D = -16 A$		2.9	4.4	
Forward Transconductance	$g_{FS}$	$V_{DS} = -5 V, I_D = -16 A$		87		S

### CHARGES AND CAPACITANCES

Input Capacitance	$C_{iss}$	$V_{GS} = 0 V, V_{DS} = -15 V, f = 1.0 \text{ MHz}$		7880		$pF$
Output Capacitance	$C_{oss}$			2630		
Reverse Transfer Capacitance	$C_{rss}$			2550		
Total Gate Charge	$Q_{G(TOT)}$	$V_{GS} = -4.5 V, V_{DS} = -15 V, I_D = -22 A$		112		$nC$
Threshold Gate Charge	$Q_{G(TH)}$			8		
Gate-to-Source Charge	$Q_{GS}$			16		
Gate-to-Drain Charge	$Q_{GD}$			76		
Total Gate Charge	$Q_{G(TOT)}$	$V_{GS} = -10 V, V_{DS} = -15 V, I_D = -22 A$		183		

### SWITCHING CHARACTERISTICS, $V_{GS} = 4.5 V$ (Note 4)

Turn-On Delay Time	$t_{d(on)}$	$V_{GS} = -4.5 V, V_{DS} = -15 V, I_D = -22 A, R_G = 6 \Omega$		56		$ns$
Rise Time	$t_r$			308		
Turn-Off Delay Time	$t_{d(off)}$			124		
Fall Time	$t_f$			269		

### SWITCHING CHARACTERISTICS, $V_{GS} = 10 V$ (Note 4)

Turn-On Delay Time	$t_{d(on)}$	$V_{GS} = -10 V, V_{DS} = -15 V, I_D = -22 A, R_G = 6 \Omega$		22		$ns$
Rise Time	$t_r$			79		
Turn-Off Delay Time	$t_{d(off)}$			220		
Fall Time	$t_f$			258		

### DRAIN-SOURCE DIODE CHARACTERISTICS

Forward Diode Voltage	$V_{SD}$	$V_{GS} = 0 V, I_S = -22 A$	$T_J = 25^{\circ}C$		-0.77	-1.3	V
			$T_J = 125^{\circ}C$		-0.63		

# NTMFS005P03P8Z

## ELECTRICAL CHARACTERISTICS (T<sub>J</sub> = 25°C unless otherwise noted)

Parameter	Symbol	Test Condition	Min	Typ	Max	Unit
<b>DRAIN-SOURCE DIODE CHARACTERISTICS</b>						
Reverse Recovery Time	t <sub>RR</sub>	V <sub>GS</sub> = 0 V, dI <sub>S</sub> /dt = 100 A/μs, I <sub>S</sub> = -22 A		57		ns
Charge Time	t <sub>a</sub>			34		
Discharge Time	t <sub>b</sub>			23		
Reverse Recovery Charge	Q <sub>RR</sub>			77		nC

Product parametric performance is indicated in the Electrical Characteristics for the listed test conditions, unless otherwise noted. Product performance may not be indicated by the Electrical Characteristics if operated under different conditions.

4. Pulse Test: Pulse Width ≤ 300 μs, Duty Cycle ≤ 2%.

TYPICAL CHARACTERISTICS

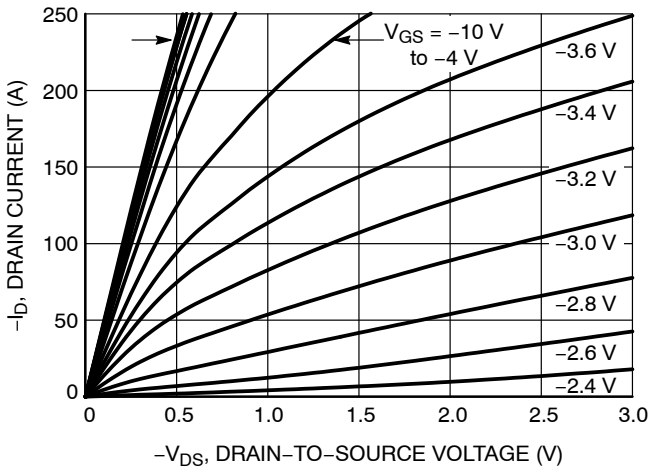

Figure 1. On-Region Characteristics

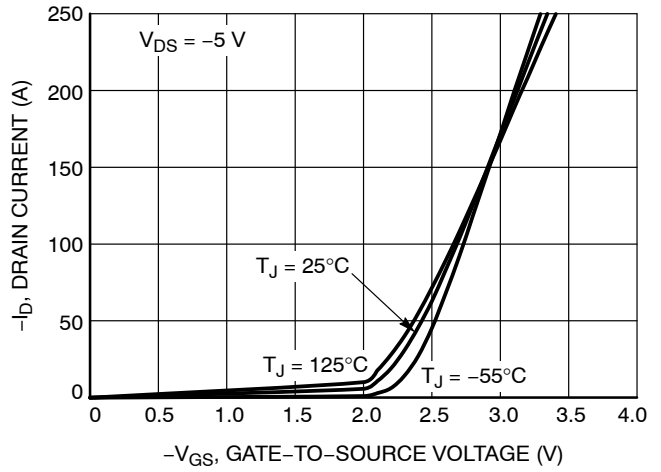

Figure 2. Transfer Characteristics

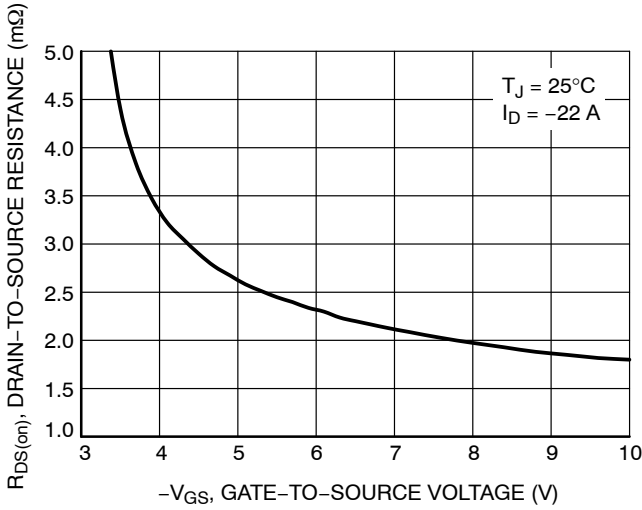

Figure 3. On-Resistance vs. Gate-to-Source Voltage

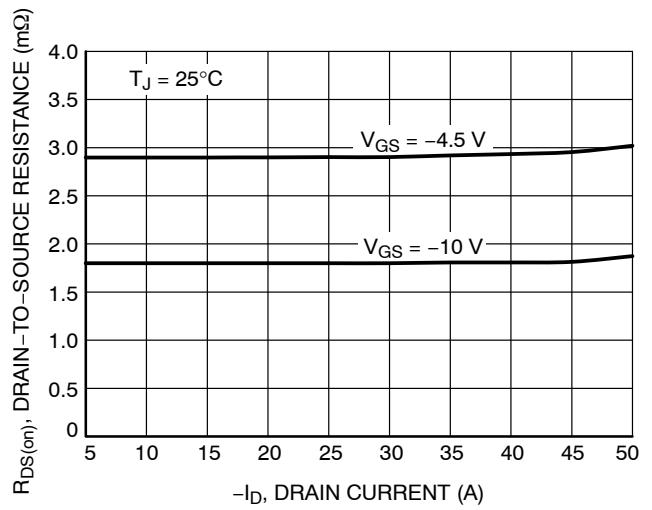

Figure 4. On-Resistance vs. Drain Current and Gate Voltage

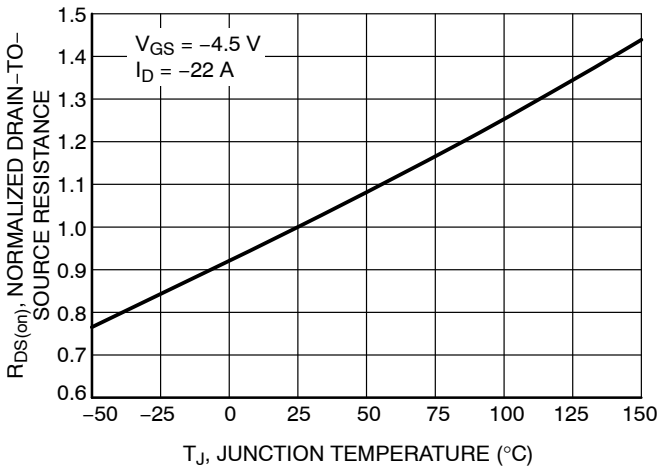

Figure 5. On-Resistance Variation with Temperature

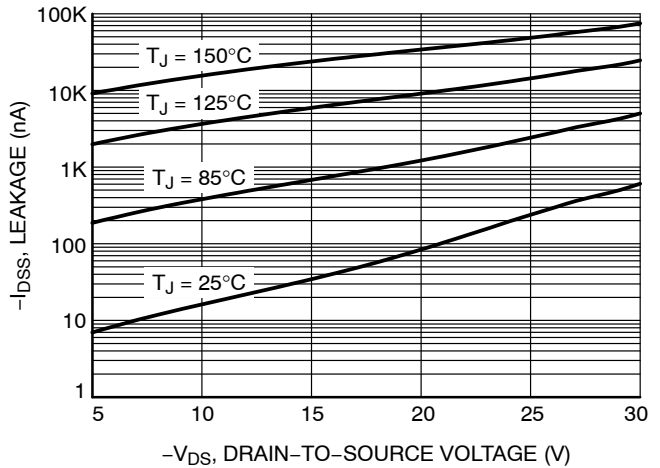

Figure 6. Drain-to-Source Leakage Current vs. Voltage

# NTMFS005P03P8Z

## TYPICAL CHARACTERISTICS

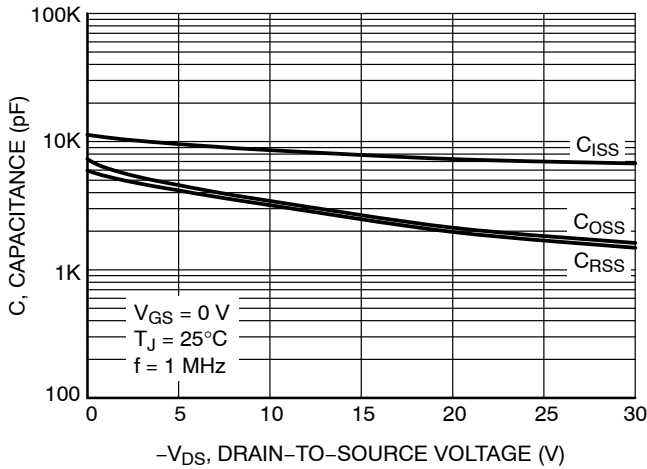

Figure 7. Capacitance Variation

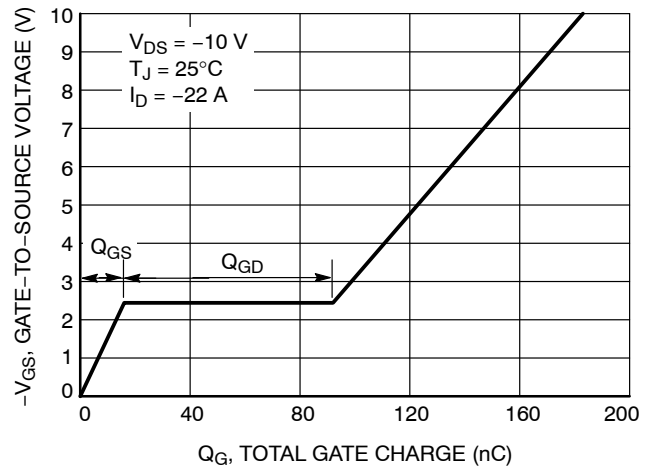

Figure 8. Gate-to-Source Voltage vs. Total Charge

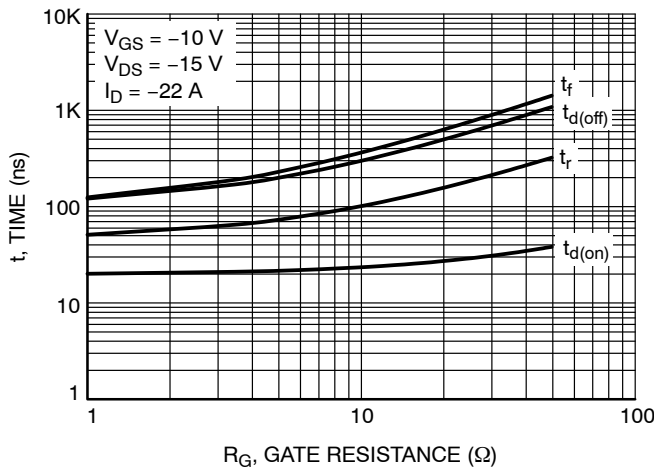

Figure 9. Resistive Switching Time Variation vs. Gate Resistance

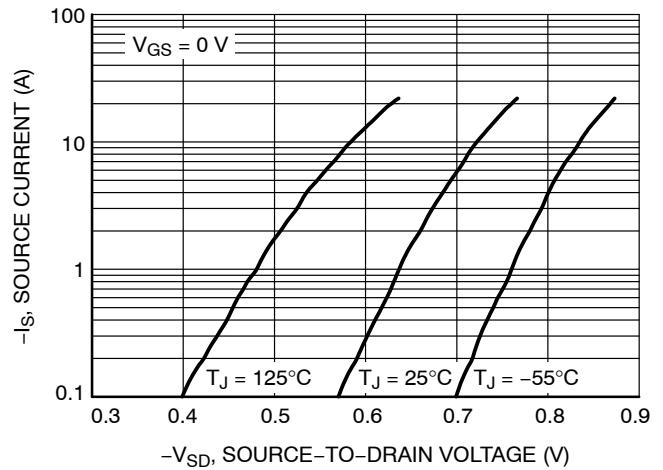

Figure 10. Diode Forward Voltage vs. Current

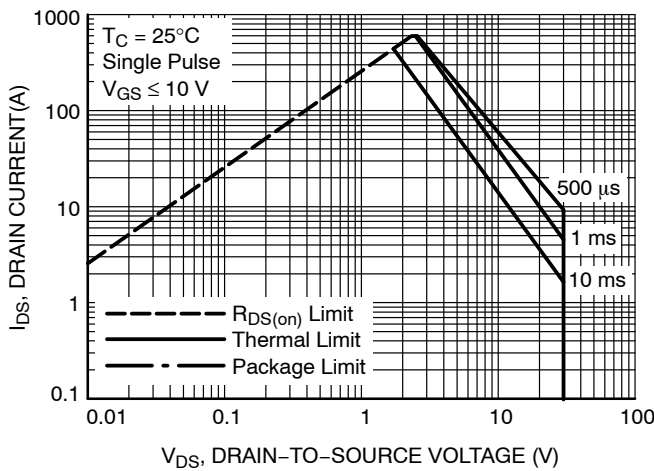

Figure 11. Maximum Rated Forward Biased Safe Operating Area

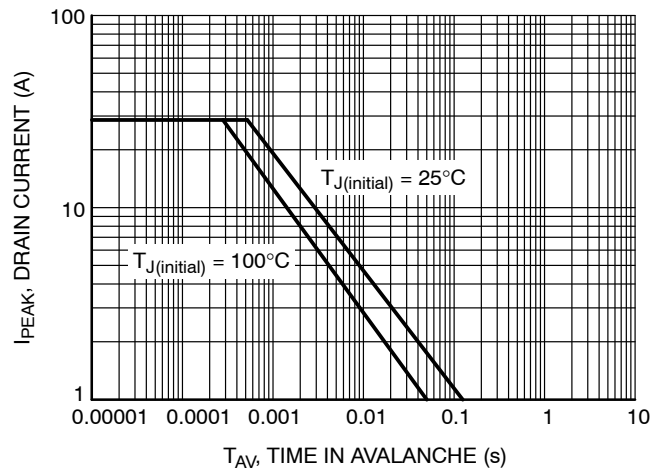

Figure 12.  $I_{PEAK}$  vs. Time in Avalanche

# NTMFS005P03P8Z

## TYPICAL CHARACTERISTICS

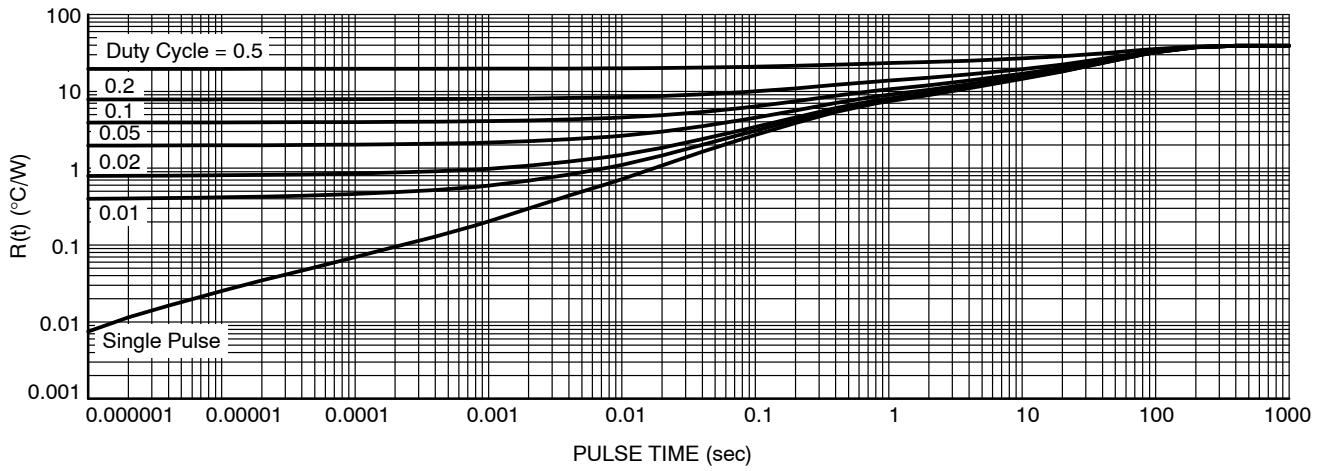

Figure 13. Thermal Characteristics

# NTMFS005P03P8Z

## PACKAGE DIMENSIONS

DFN5 5x6, 1.27P  
(SO-8FL)  
CASE 488AA  
ISSUE N

NOTES:

1. DIMENSIONING AND TOLERANCING PER ASME Y14.5M, 1994.
2. CONTROLLING DIMENSION: MILLIMETER.
3. DIMENSION D1 AND E1 DO NOT INCLUDE MOLD FLASH PROTRUSIONS OR GATE BURRS.

DIM	MILLIMETERS		
	MIN	NOM	MAX
A	0.90	1.00	1.10
A1	0.00	---	0.05
b	0.33	0.41	0.51
c	0.23	0.28	0.33
D	5.00	5.15	5.30
D1	4.70	4.90	5.10
D2	3.80	4.00	4.20
E	6.00	6.15	6.30
E1	5.70	5.90	6.10
E2	3.45	3.65	3.85
e	1.27 BSC		
G	0.51	0.575	0.71
K	1.20	1.35	1.50
L	0.51	0.575	0.71
L1	0.125 REF		
M	3.00	3.40	3.80
θ	0°	---	12°

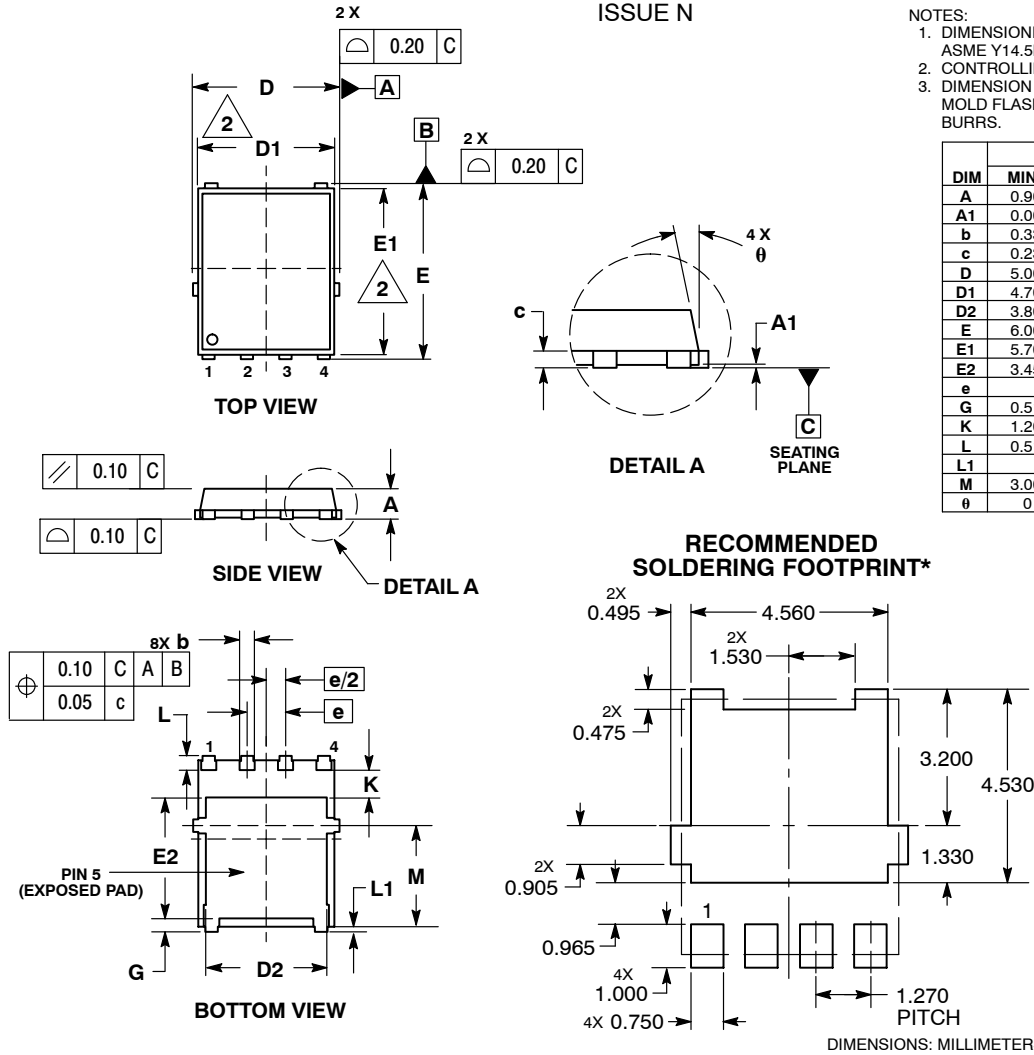

STYLE 1:  
PIN 1. SOURCE  
2. SOURCE  
3. SOURCE  
4. GATE  
5. DRAIN

\*For additional information on our Pb-Free strategy and soldering details, please download the ON Semiconductor Soldering and Mounting Techniques Reference Manual, SOLDERRM/D.

ON Semiconductor and are trademarks of Semiconductor Components Industries, LLC dba ON Semiconductor or its subsidiaries in the United States and/or other countries. ON Semiconductor owns the rights to a number of patents, trademarks, copyrights, trade secrets, and other intellectual property. A listing of ON Semiconductor's product/patent coverage may be accessed at [www.onsemi.com/site/pdf/Patent-Marking.pdf](http://www.onsemi.com/site/pdf/Patent-Marking.pdf). ON Semiconductor reserves the right to make changes without further notice to any products herein. ON Semiconductor makes no warranty, representation or guarantee regarding the suitability of its products for any particular purpose, nor does ON Semiconductor assume any liability arising out of the application or use of any product or circuit, and specifically disclaims any and all liability, including without limitation special, consequential or incidental damages. Buyer is responsible for its products and applications using ON Semiconductor products, including compliance with all laws, regulations and safety requirements or standards, regardless of any support or applications information provided by ON Semiconductor. "Typical" parameters which may be provided in ON Semiconductor data sheets and/or specifications can and do vary in different applications and actual performance may vary over time. All operating parameters, including "Typicals" must be validated for each customer application by customer's technical experts. ON Semiconductor does not convey any license under its patent rights nor the rights of others. ON Semiconductor products are not designed, intended, or authorized for use as a critical component in life support systems or any FDA Class 3 medical devices or medical devices with a same or similar classification in a foreign jurisdiction or any devices intended for implantation in the human body. Should Buyer purchase or use ON Semiconductor products for any such unintended or unauthorized application, Buyer shall indemnify and hold ON Semiconductor and its officers, employees, subsidiaries, affiliates, and distributors harmless against all claims, costs, damages, and expenses, and reasonable attorney fees arising out of, directly or indirectly, any claim of personal injury or death associated with such unintended or unauthorized use, even if such claim alleges that ON Semiconductor was negligent regarding the design or manufacture of the part. ON Semiconductor is an Equal Opportunity/Affirmative Action Employer. This literature is subject to all applicable copyright laws and is not for resale in any manner.

### PUBLICATION ORDERING INFORMATION

LITERATURE FULFILLMENT:  
Email Requests to: [orderlit@onsemi.com](mailto:orderlit@onsemi.com)

TECHNICAL SUPPORT  
North American Technical Support:  
Voice Mail: 1 800-282-9855 Toll Free USA/Canada  
Phone: 011 421 33 790 2910

Europe, Middle East and Africa Technical Support:  
Phone: 00421 33 790 2910  
For additional information, please contact your local Sales Representative