

MOSFET – N-Channel, POWERTRENCH®

40 V, 7.6 A, 29 mΩ

FDS8449, FDS8449-G

General Description

These N-Channel MOSFETs are produced using onsemi's advanced POWERTRENCH process that has been especially tailored to minimize on-state resistance and yet maintain superior switching performance.

Features

- 7.6 A, 40 V $R_{DS(on)} = 29\text{ m}\Omega @ V_{GS} = 10\text{ V}$
 $R_{DS(on)} = 36\text{ m}\Omega @ V_{GS} = 4.5\text{ V}$
- High Power Handling Capability in a Widely Used Surface Mount Package
- Pb-Free, Halide Free and RoHS Compliant

ABSOLUTE MAXIMUM RATINGS

$T_A = 25^\circ\text{C}$ unless otherwise noted.

| Symbol | Parameter | Ratings | Unit |
|----------------|--|-------------|------------------|
| V_{DSS} | Drain to Source Voltage | 40 | V |
| V_{GSS} | Gate to Source Voltage | ± 20 | V |
| I_D | Drain Current – Continuous (Note 1a) – Pulsed | 7.6 50 | A |
| P_D | Power Dissipation for Single Operation (Note 1a) (Note 1b) | 2.5 1 | W |
| T_J, T_{STG} | Operating and Storage Junction Temperature Range | -55 to +150 | $^\circ\text{C}$ |

Stresses exceeding those listed in the Maximum Ratings table may damage the device. If any of these limits are exceeded, device functionality should not be assumed, damage may occur and reliability may be affected.

THERMAL CHARACTERISTICS

| Symbol | Parameter | Ratings | Unit |
|-----------------|---|---------|--------------------|
| $R_{\theta JA}$ | Thermal Resistance, Junction to Ambient (Note 1a) | 50 | $^\circ\text{C/W}$ |
| $R_{\theta JA}$ | Thermal Resistance, Junction to Ambient (Note 1b) | 125 | $^\circ\text{C/W}$ |
| $R_{\theta JC}$ | Thermal Resistance, Junction to Case (Note 1) | 25 | $^\circ\text{C/W}$ |

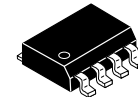

SOIC8
CASE 751EB

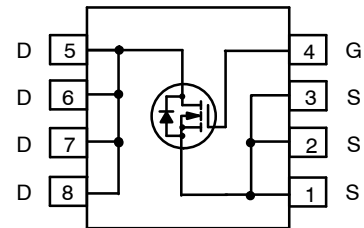

MARKING DIAGRAM

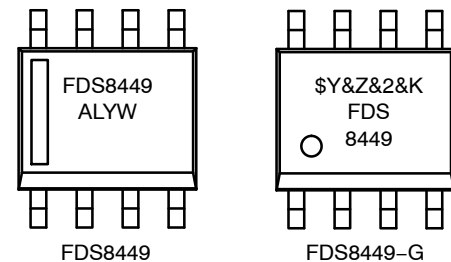

- FDS8449 = Specific Device Code
A = Assembly Site
L = Wafer Lot Number
YW = Assembly Start Week
\$Y = onsemi Logo
&Z = Assembly Plant Code
&2 = 2-Digit Code Format
&K = 2-Digits Lot Run Traceability Code

ORDERING INFORMATION

| Device | Package | Shipping† |
|-----------|------------------------------------|-----------------------|
| FDS8449 | SOIC8 (Pb-Free/ Halide Free) | 2500 / Tape & Reel |
| FDS8449-G | SOIC8 (Pb-Free/ Halide Free) | 2500 / Tape & Reel |

†For information on tape and reel specifications, including part orientation and tape sizes, please refer to our Tape and Reel Packaging Specification Brochure, [BRD8011/D](#).

FDS8449, FDS8449-G

ELECTRICAL CHARACTERISTICS $T_A = 25^\circ\text{C}$ unless otherwise noted.

| Symbol | Parameter | Test Conditions | Min | Typ | Max | Unit |
|--------|-----------|-----------------|-----|-----|-----|------|
|--------|-----------|-----------------|-----|-----|-----|------|

DRAIN-SOURCE AVALANCHE RATINGS (Note 3)

| | | | | | | |
|----------|-----------------------------------|---|---|-----|----|----|
| E_{AS} | Drain to Source Avalanche Energy | $V_{DD} = 40\text{ V}, I_D = 7.3\text{ A}, L = 1\text{ mH}$ | - | - | 27 | mJ |
| I_{AS} | Drain to Source Avalanche Current | | - | 7.3 | - | A |

OFF CHARACTERISTICS

| | | | | | | |
|--------------------------------------|---|---|----|----|-----------|----------------------|
| BV_{DSS} | Drain to Source Breakdown Voltage | $I_D = 250\ \mu\text{A}, V_{GS} = 0\text{ V}$ | 40 | - | - | V |
| $\frac{\Delta BV_{DSS}}{\Delta T_J}$ | Breakdown Voltage Temperature Coefficient | $I_D = 250\ \mu\text{A}$, Referenced to 25°C | - | 34 | - | mV/ $^\circ\text{C}$ |
| I_{DSS} | Zero Gate Voltage Drain Current | $V_{DS} = 32\text{ V}, V_{GS} = 0\text{ V}$ | - | - | 1 | μA |
| I_{GSS} | Gate-Body Leakage | $V_{GS} = \pm 20\text{ V}, V_{DS} = 0\text{ V}$ | - | - | ± 100 | nA |

ON CHARACTERISTICS (Note 2)

| | | | | | | |
|--|--|---|---|-----|----|----------------------|
| $V_{GS(th)}$ | Gate Threshold Voltage | $V_{DS} = V_{GS}, I_D = 250\ \mu\text{A}$ | 1 | 1.9 | 3 | V |
| $\frac{\Delta V_{GS(th)}}{\Delta T_J}$ | Gate Threshold Voltage Temperature Coefficient | $I_D = 250\ \mu\text{A}$, Referenced to 25°C | - | -5 | - | mV/ $^\circ\text{C}$ |
| $R_{DS(on)}$ | Static Drain to Source On-Resistance | $I_D = 7.6\text{ A}, V_{GS} = 10\text{ V}$, | - | 21 | 29 | m Ω |
| | | $I_D = 6.8\text{ A}, V_{GS} = 4.5\text{ V}$ | - | 26 | 36 | |
| | | $I_D = 7.6\text{ A}, V_{GS} = 10\text{ V}$, $T_J = 125^\circ\text{C}$ | - | 29 | 43 | |
| g_{FS} | Forward Transconductance | $V_{DS} = 10\text{ V}, I_D = 7.6\text{ A}$ | - | 21 | - | S |

DYNAMIC CHARACTERISTICS

| | | | | | | |
|-----------|------------------------------|---|---|-----|---|----------|
| C_{iss} | Input Capacitance | $V_{DS} = 20\text{ V}, V_{GS} = 0\text{ V}$, $f = 1.0\text{ MHz}$ | - | 760 | - | pF |
| C_{oss} | Output Capacitance | | - | 100 | - | |
| C_{rss} | Reverse Transfer Capacitance | | - | 60 | - | |
| R_G | Gate Resistance | $f = 1.0\text{ MHz}$ | - | 1.2 | - | Ω |

SWITCHING CHARACTERISTICS (Note 2)

| | | | | | | |
|--------------|---------------------|--|---|-----|----|----|
| $t_{d(on)}$ | Turn-On Delay Time | $V_{DD} = 20\text{ V}, I_D = 1\text{ A}$, $V_{GS} = 10\text{ V}, R_{GS} = 6\ \Omega$ | - | 9 | 18 | ns |
| t_r | Turn-On Rise Time | | - | 5 | 10 | |
| $t_{d(off)}$ | Turn-Off Delay Time | | - | 23 | 17 | |
| t_f | Turn-Off Fall Time | | - | 3 | 6 | |
| Q_g | Total Gate Charge | $V_{DS} = 20\text{ V}, I_D = 7.6\text{ A}$, $V_{GS} = 5\text{ V}$ | - | 7.7 | 11 | nC |
| Q_{gs} | Gate-Source Charge | | - | 2.4 | - | |
| Q_{gd} | Gate-Drain Charge | | - | 2.8 | - | |

DRAIN-SOURCE DIODE CHARACTERISTICS

| | | | | | | |
|----------|---------------------------------------|--|---|------|-----|----|
| V_{SD} | Drain to Source Diode Forward Voltage | $V_{GS} = 0\text{ V}, I_S = 2.1\text{ A}$ (Note 2) | - | 0.76 | 1.2 | V |
| t_{rr} | Diode Reverse Recovery Time | $I_F = 7.6\text{ A}, dI_F/dt = 100\text{ A}/\mu\text{s}$ | - | 17 | - | ns |
| Q_{rr} | Diode Reverse Recovery Charge | | - | 7 | - | nC |

Product parametric performance is indicated in the Electrical Characteristics for the listed test conditions, unless otherwise noted. Product performance may not be indicated by the Electrical Characteristics if operated under different conditions.

NOTES:

- $R_{\theta JA}$ is the sum of the junction-to-case and case-to-ambient thermal resistance where the case thermal reference is defined as the solder mounting surface of the drain pins. $R_{\theta JC}$ is guaranteed by design while $R_{\theta CA}$ is determined by the user's board design.



a) $50^\circ\text{C}/\text{W}$ when mounted on a 1 in² pad of 2 oz. copper.



b) $125^\circ\text{C}/\text{W}$ when mounted on a minimum pad.

- Pulse Test: Pulse Width < 300 μs , Duty Cycle < 2.0%
- $BV(\text{avalanche})$ Single-Pulse rating is guaranteed if device is operated within the UIS SOA boundary of the device.

TYPICAL CHARACTERISTICS

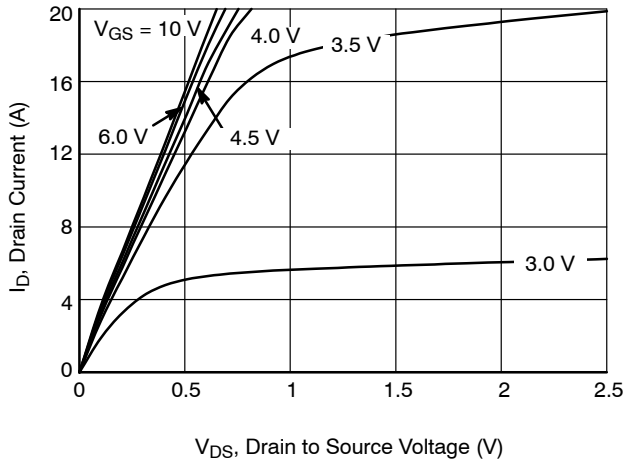

Figure 1. On Region Characteristics

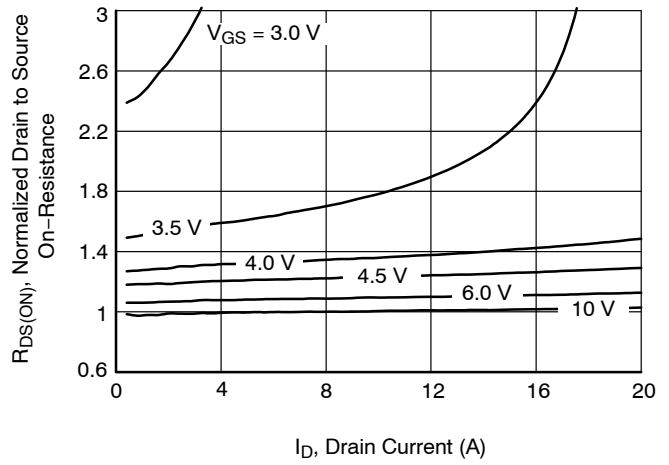

Figure 2. On-Resistance Variation with Drain Current and Gate Voltage

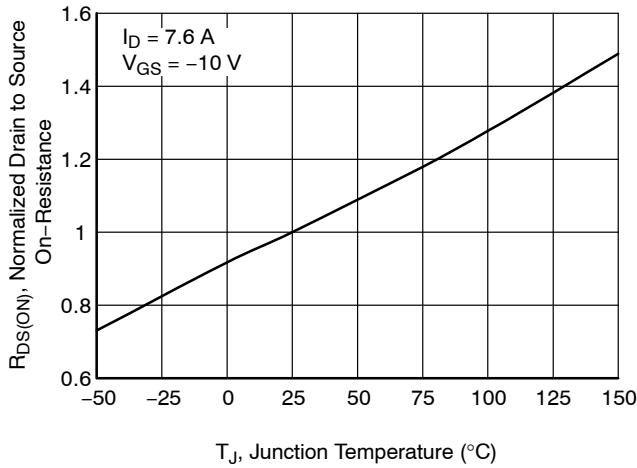

Figure 3. On-Resistance Variation with Temperature

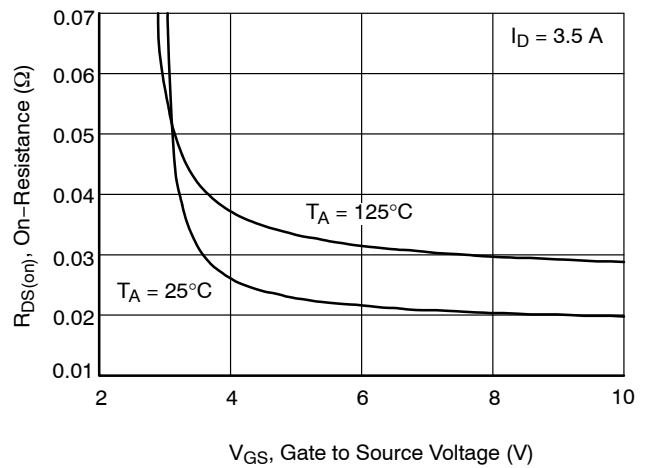

Figure 4. On-Resistance Variation with Gate-to-Source Voltage

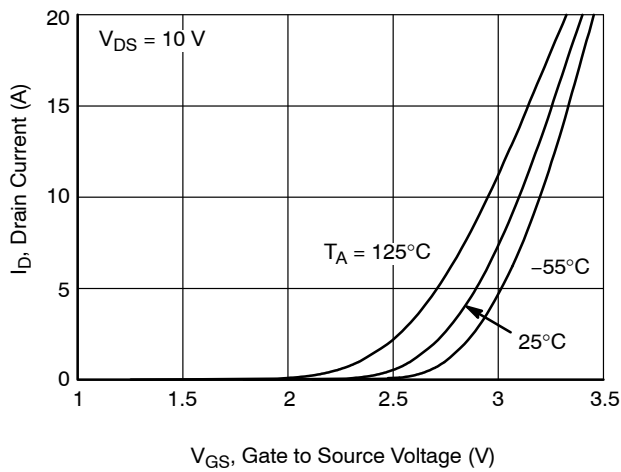

Figure 5. Transfer Characteristics

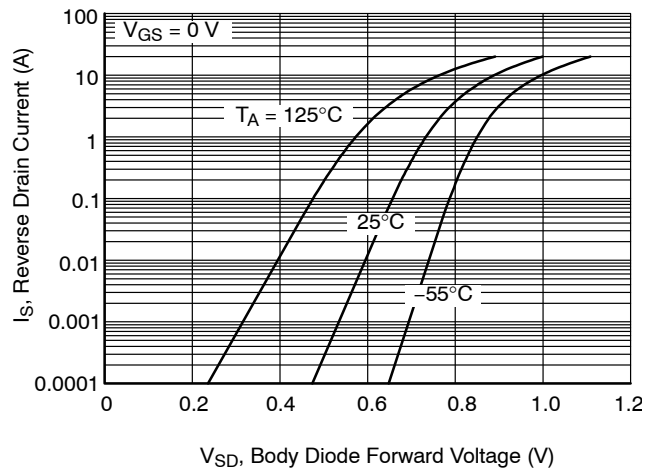

Figure 6. Body Diode Forward Voltage Variation with Source Current and Temperature

TYPICAL CHARACTERISTICS (continued)

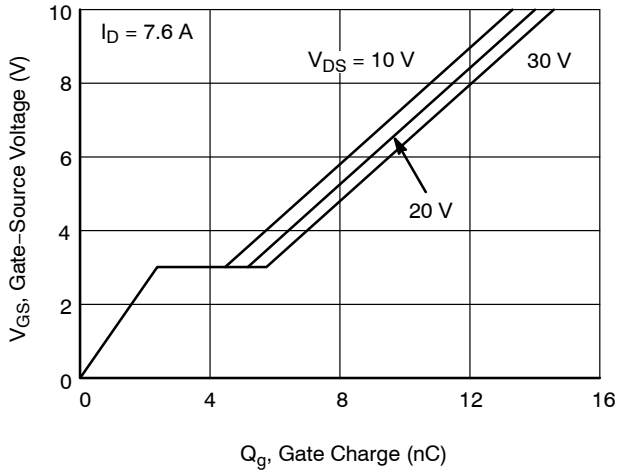

Figure 7. Gate Charge Characteristics

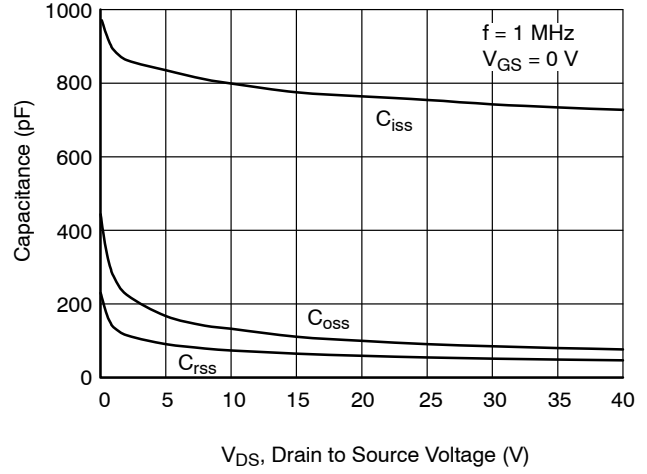

Figure 8. Capacitance Characteristics

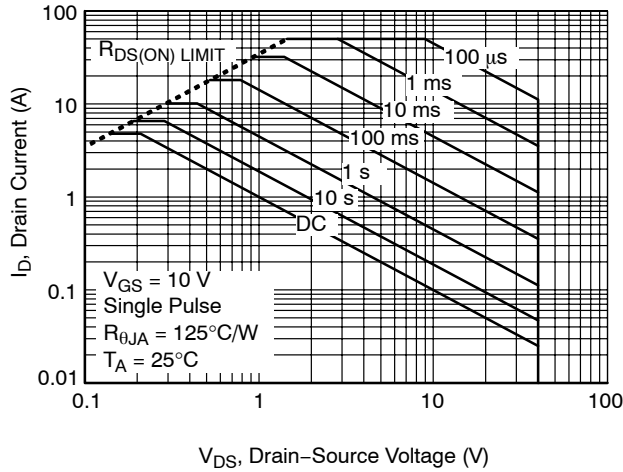

Figure 9. Maximum Safe Operating Area

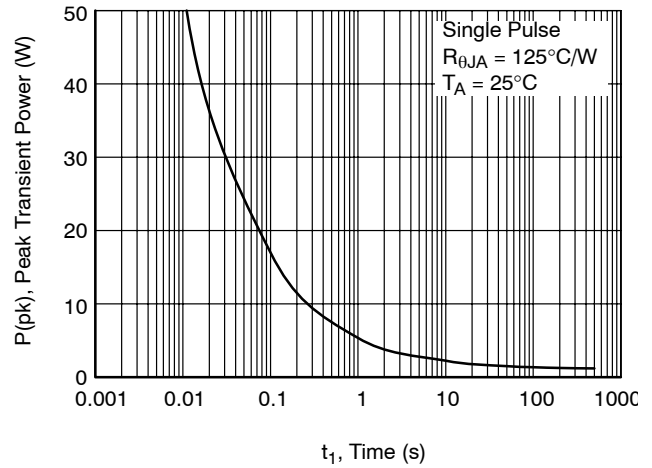

Figure 10. Single Pulse Maximum Power Dissipation

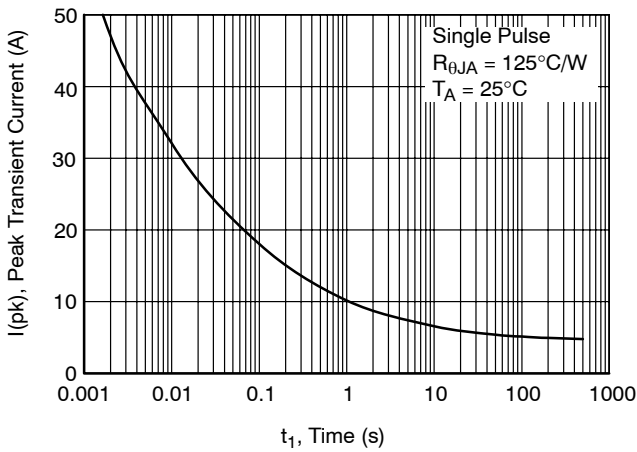

Figure 11. Single Pulse Maximum Peak Current

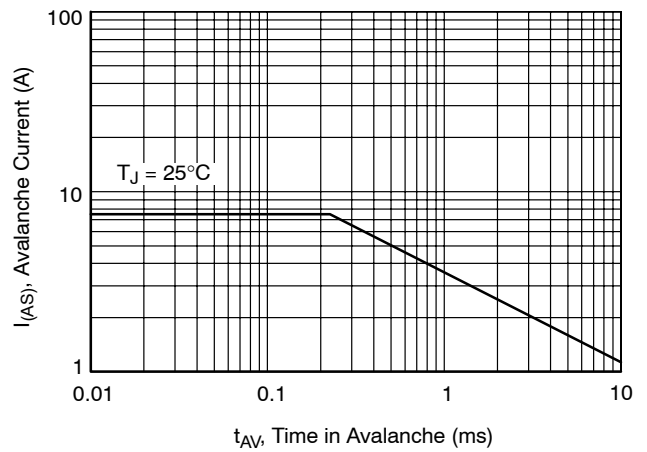

Figure 12. Unclamped Inductive Switching Capability

TYPICAL CHARACTERISTICS (continued)

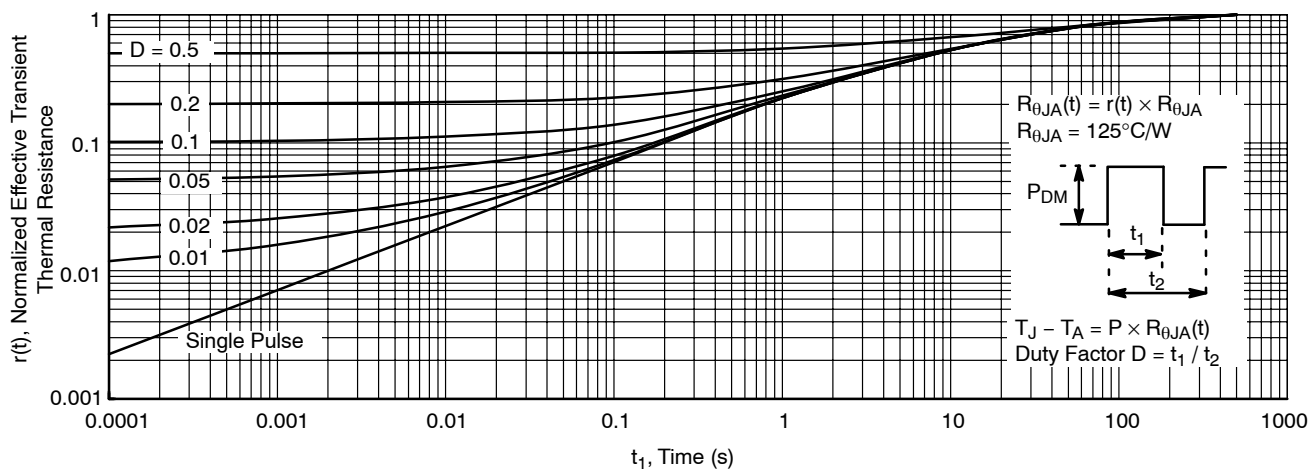

Figure 13. Transient Thermal Response Curve

NOTE: Transient thermal response will change depending on the circuit board design.

MECHANICAL CASE OUTLINE
PACKAGE DIMENSIONS

ON Semiconductor®



SOIC8
CASE 751EB
ISSUE A

DATE 24 AUG 2017

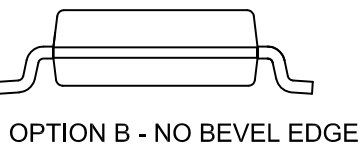
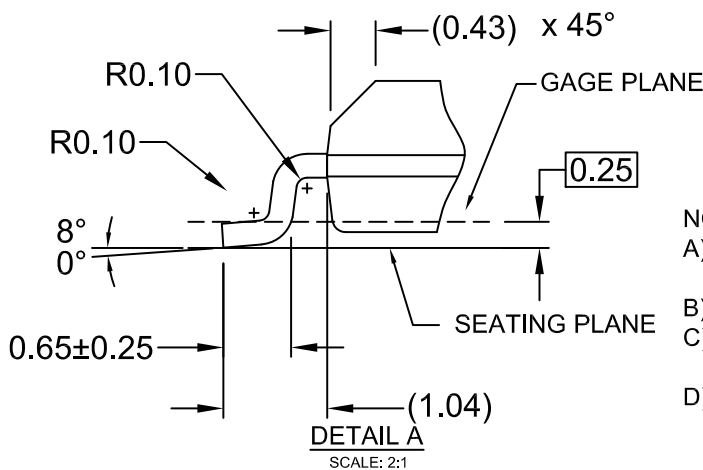
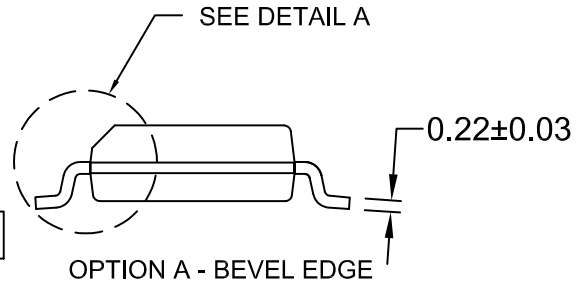
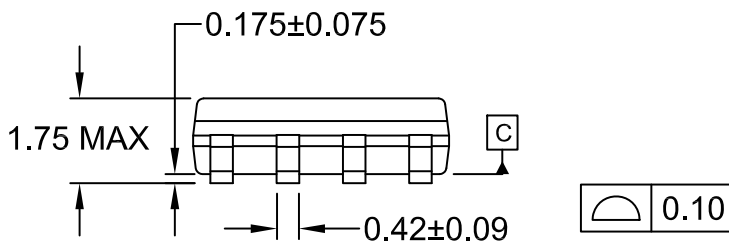
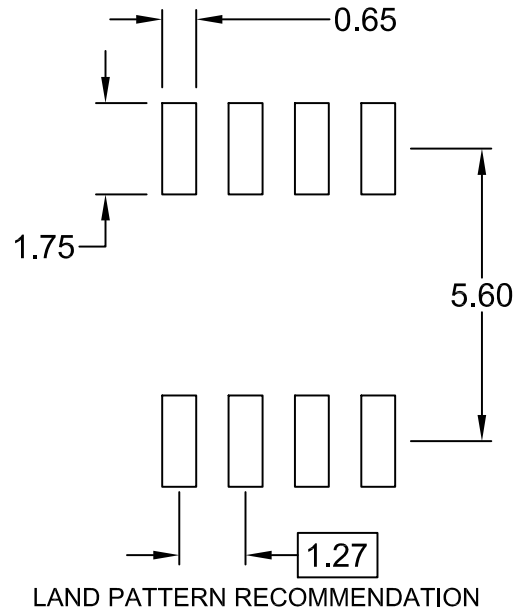
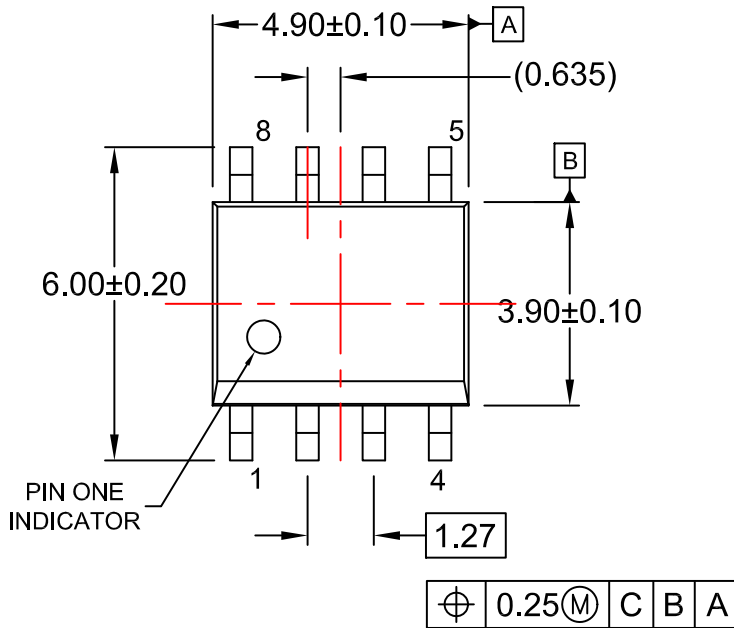

- NOTES:
 A) THIS PACKAGE CONFORMS TO JEDEC MS-012, VARIATION AA.
 B) ALL DIMENSIONS ARE IN MILLIMETERS.
 C) DIMENSIONS DO NOT INCLUDE MOLD FLASH OR BURRS.
 D) LANDPATTERN STANDARD: SOIC127P600X175-8M

| | | |
|-------------------------|--------------------|--|
| DOCUMENT NUMBER: | 98AON13735G | Electronic versions are uncontrolled except when accessed directly from the Document Repository. Printed versions are uncontrolled except when stamped "CONTROLLED COPY" in red. |
| DESCRIPTION: | SOIC8 | PAGE 1 OF 1 |

ON Semiconductor and are trademarks of Semiconductor Components Industries, LLC dba ON Semiconductor or its subsidiaries in the United States and/or other countries. ON Semiconductor reserves the right to make changes without further notice to any products herein. ON Semiconductor makes no warranty, representation or guarantee regarding the suitability of its products for any particular purpose, nor does ON Semiconductor assume any liability arising out of the application or use of any product or circuit, and specifically disclaims any and all liability, including without limitation special, consequential or incidental damages. ON Semiconductor does not convey any license under its patent rights nor the rights of others.

onsemi, **Onsemi**, and other names, marks, and brands are registered and/or common law trademarks of Semiconductor Components Industries, LLC dba "**onsemi**" or its affiliates and/or subsidiaries in the United States and/or other countries. **onsemi** owns the rights to a number of patents, trademarks, copyrights, trade secrets, and other intellectual property. A listing of **onsemi**'s product/patent coverage may be accessed at www.onsemi.com/site/pdf/Patent-Marking.pdf. **onsemi** reserves the right to make changes at any time to any products or information herein, without notice. The information herein is provided "as-is" and **onsemi** makes no warranty, representation or guarantee regarding the accuracy of the information, product features, availability, functionality, or suitability of its products for any particular purpose, nor does **onsemi** assume any liability arising out of the application or use of any product or circuit, and specifically disclaims any and all liability, including without limitation special, consequential or incidental damages. Buyer is responsible for its products and applications using **onsemi** products, including compliance with all laws, regulations and safety requirements or standards, regardless of any support or applications information provided by **onsemi**. "Typical" parameters which may be provided in **onsemi** data sheets and/or specifications can and do vary in different applications and actual performance may vary over time. All operating parameters, including "Typicals" must be validated for each customer application by customer's technical experts. **onsemi** does not convey any license under any of its intellectual property rights nor the rights of others. **onsemi** products are not designed, intended, or authorized for use as a critical component in life support systems or any FDA Class 3 medical devices or medical devices with a same or similar classification in a foreign jurisdiction or any devices intended for implantation in the human body. Should Buyer purchase or use **onsemi** products for any such unintended or unauthorized application, Buyer shall indemnify and hold **onsemi** and its officers, employees, subsidiaries, affiliates, and distributors harmless against all claims, costs, damages, and expenses, and reasonable attorney fees arising out of, directly or indirectly, any claim of personal injury or death associated with such unintended or unauthorized use, even if such claim alleges that **onsemi** was negligent regarding the design or manufacture of the part. **onsemi** is an Equal Opportunity/Affirmative Action Employer. This literature is subject to all applicable copyright laws and is not for resale in any manner.

PUBLICATION ORDERING INFORMATION

LITERATURE FULFILLMENT:

Email Requests to: orderlit@onsemi.com

onsemi Website: www.onsemi.com

TECHNICAL SUPPORT

North American Technical Support:

Voice Mail: 1 800-282-9855 Toll Free USA/Canada

Phone: 011 421 33 790 2910

Europe, Middle East and Africa Technical Support:

Phone: 00421 33 790 2910

For additional information, please contact your local Sales Representative