



MB5400

Modbus Gateway

User's Manual



Important Announcement

The information contained in this document is the property of Atop technologies, Inc., and is supplied for the sole purpose of operation and maintenance of Atop Technologies, Inc., products. No part of this publication is to be used for any other purposes, and it is not to be reproduced, copied, disclosed, transmitted, stored in a retrieval system, or translated into any human or computer language, in any form, by any means, in whole or in part, without the prior explicit written consent of Atop Technologies, Inc., offenders will be held liable for damages. All rights, including rights created by patent grant or registration of a utility model or design, are reserved.

Disclaimer

We have checked the contents of this manual for agreement with the hardware and software described. Since deviations cannot be precluded entirely, we cannot guarantee full agreement. However, the data in this manual is reviewed regularly and any necessary corrections included in subsequent editions. Suggestions for improvement are welcomed. All other product's names referenced herein are registered trademarks of their respective companies.

Published and printed by

Atop Technologies, Inc.

2F, No. 146, Sec. 1, Tung-Hsing Rd.

Jubei, Hsinchu 30261

Taiwan, R.O.C.

Tel.: 886-3-5508137

Fax: 886-3-5508131

www.atop-tech.com

www.atop.com.tw

Copyright © 2011 Atop Technologies, Inc. All rights reserved. Technical data is subject to change. All other product names referenced herein are registered trademarks of their own respective companies.

Content

Preface	5
1 Introduction	7
1.1 Overview	7
1.2 Features	9
2 Getting Started	10
2.1 First Time Installation	10
2.2 Factory Default Settings.....	11
3 Configuration and Setup	13
3.1 Locating and IP configuring using Serial Manager©.....	13
3.2 Configuring using Web Interface.....	15
3.3 LCM (Liquid Crystal Matrix) Configuration.....	17
3.4 Configuring Automatic IP Assignment with DHCP	21
3.5 Web Overview.....	21
3.6 Network Configuration	22
3.7 Basic Settings.....	26
3.7.1 COM Settings.....	26
3.7.2 Operation Mode	27
3.7.3 Serial Settings.....	28
3.7.4 VCOM Settings	29
3.7.5 TCP Settings.....	33
3.7.6 Slave ID Map	36
3.8 Advanced Settings	38
3.8.1 SNMP Settings.....	38
3.8.2 Modbus	39
3.9 Alert Configuration	41
3.9.1 SMTP and E-mail Settings.....	41
3.9.2 Alert Events.....	42
3.10 System.....	45
3.10.1 Log Settings	45
3.10.2 System Log	46
3.10.3 Data Log.....	47
3.10.4 Modbus Statistics.....	48

3.10.5 Time	49
3.10.6 Security	52
3.10.7 Import/Export	54
3.10.8 Factory Default.....	57
3.11 Restart	58
4 Applications and Examples	59
4.1 Using ID offset range mapping	59
4.2 Using Alias ID mapping	61
5 Specifications	63
5.1 Software	63
5.2 Pin Assignments	64
6 Appendix: Configuration using Telnet Interface	68
Warranty	87

Preface

Purpose of the Manual

This manual supports you during the installation and configuring of the MB5400 Modbus Gateways only. It explains some technical options available with the mentioned product. As such, it contains some advanced network management knowledge, instructions, examples, guidelines and general theories designed to help users manage this device and its corresponding software. Some background in general theory is a must while reading it. Please refer to the Glossary for technical terms and abbreviations (if any).

Who Should Use This User Manual

This manual is to be used by qualified network personnel or support technicians who are familiar with network operations. It might be useful for system programmers or network planners as well. This manual also provides helpful and handy information for first time users. For any related problems, please contact your local distributor, should they be unable to assist you, please redirect your inquiries to www.atop.com.tw or www.atop-tech.com .

Supported Platform

This manual is designed for the MB5400 Modbus Gateways and that models only.

Warranty Period

We provide a 5-year limited warranty for the MB5400 Modbus Gateways.

Manufacturers Federal Communication Commission Declaration of Conformity Statement

Model: MB5400 Modbus Gateways

NOTE: This equipment has been tested and found to comply with the limits for a Class A digital device, pursuant to Part 15 of the FCC Rules. These limits are designed to provide reasonable protection against harmful interference when the equipment is operated in a commercial environment. This equipment generates, uses, and can radiate radio frequency energy and, if not installed and used in accordance with the instruction manual, may cause harmful interference to radio communications. Operation of this equipment in a residential area is likely to cause harmful interference in which case the user will be required to correct the interference at his/her own expense.

This device complies with Part 15 of the FCC Rules. Operation is subject to the following two conditions:

- 1 This device may not cause harmful interference, and
- 2 This device must accept any interference received, including interference that may cause an undesired operation.

Caution

Beginning from here there will be extreme caution exercised.



Never install or work on electrical cabling during periods of lightning activity. Never connect or disconnect power when hazardous gases are present



WARNING: Disconnect the power and allow to cool 5 minutes before touching.

1 Introduction

1.1 Overview

A Modbus Gateway is a network device connecting in between Modbus over Serial Line devices and computer hosts running Modbus/TCP on Ethernet networks. Fig. 1.1 illustrates a possible network configuration of the MB5400 Modbus Gateways. Fully compliant with Modbus/TCP protocol, the Modbus Gateway offers a convenient solution to connect existing devices or controllers running Modbus serial protocol (Modbus/ASCII or Modbus/RTU) to an Ethernet network. The MB5400 Series are standard Modbus gateways that convert packets between Modbus TCP and Modbus RTU/ASCII protocols.

The MB5400 Series support 16 simultaneous TCP masters and 32 simultaneous requests for each TCP master. Each RS-232/422/485 serial port can be individually configured for Modbus/RTU or Modbus/ASCII operation or even different baud rate, allowing both types of networks to be fully integrated with Modbus/TCP within one package.

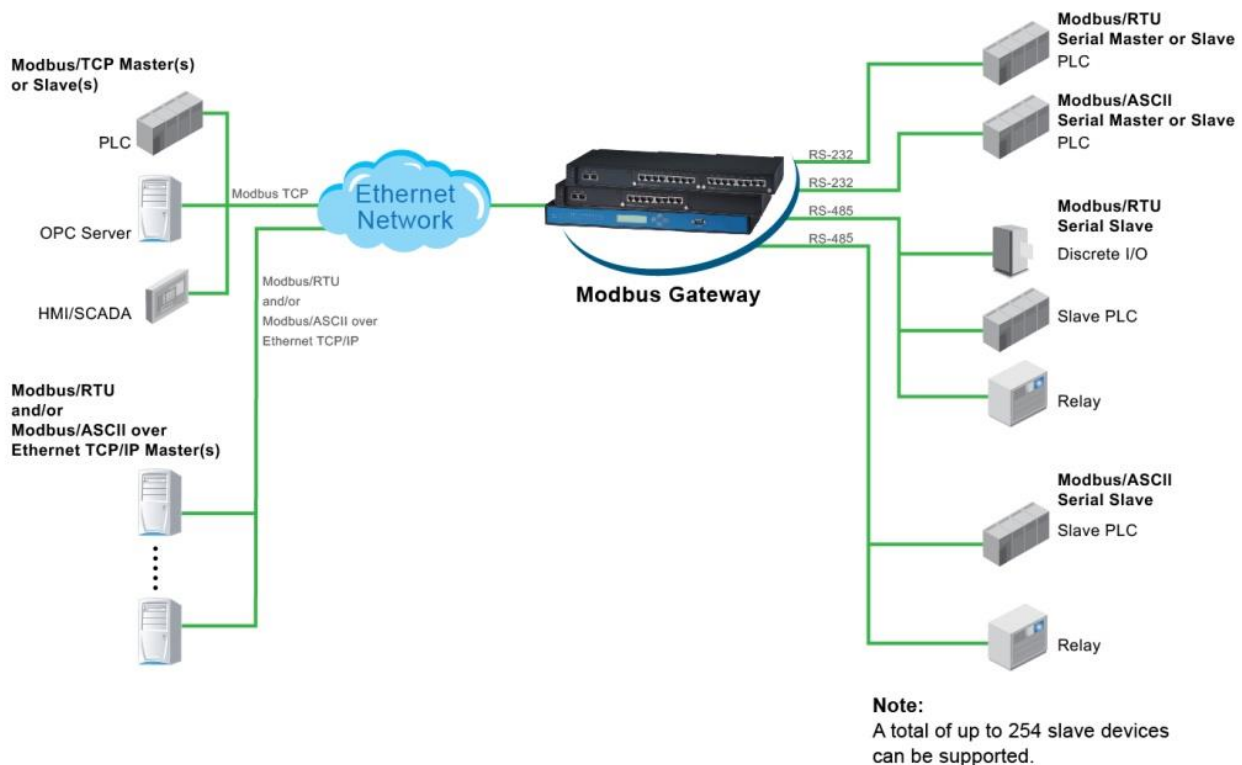

Fig. 1.1 Possible Network Configuration of MB5400 Series Modbus Gateway

Fig. 1.2 shows three different use cases of the MB5400 Modbus Gateways: the interfacing between Modbus RTU/ASCII serial host to Modbus RTU/ASCII serial devices, the interfacing between Modbus/TCP over Ethernet network to Modbus RTU/ASCII serial devices, and the interfacing between Modbus RTU/ASCII host connected through serial IP over Ethernet (virtual communication port (VCOM)) to Modbus RTU/ASCII serial devices.

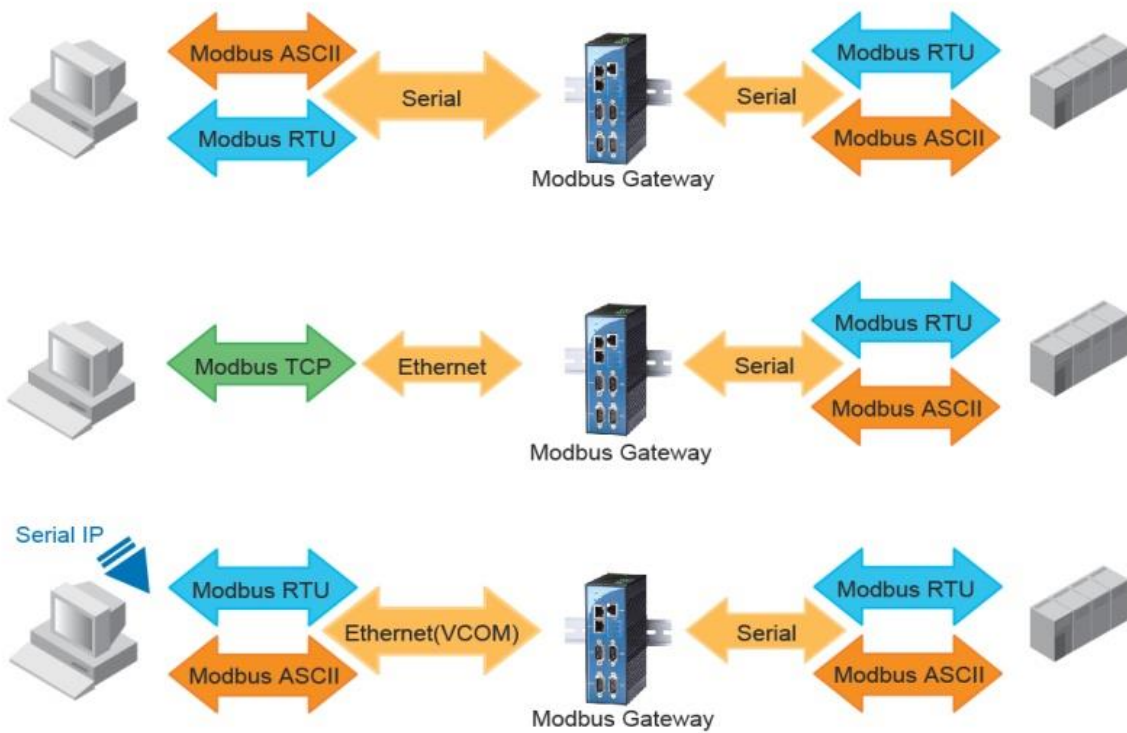

Fig. 1.2 Use Cases of MB5400 Modbus Gateways

1.2 Features

- RISC 32-bit 266 MHz CPU
- Standard 19-inch rack-mounted 1U high metal housing (MB5408A / MB5416A / MB5408A2-N / MB5416A2-N Series) or DIN-Rail mounting (MB5404D-X Series)
- RS-232/422/485 Software selectable
- Dual 10/100 Mbps Ethernet ports for network redundancy
- Configurable via Liquid Crystal Matrix (LCM) buttons (MB5408A / MB5416A / MB5408A2-N / MB5416A2-N Series only), Serial console, Telnet, Web and Windows-based utility program **Serial Manager**® or **Management Utility**
- Relay output indicator for network link status
- LCM indication with 4-keypad settings (MB5408A / MB5416A / MB5408A2-N / MB5416A2-N Series only)
- Conversion between Modbus TCP and Modbus RTU/ASCII protocols
- 2 Ethernet ports and 4, 8, or 16 RS-232/422/485 ports
- Supporting 16 simultaneous TCP masters with up to 32 simultaneous requests per master
- Easy hardware setup and configuration

2 Getting Started

2.1 First Time Installation

Before installing the device, please adhere to all safety procedures described below, Atop will not be held liable for any damages to property or personal injuries resulting from the installation or overall use of the device. Do not attempt to manipulate the product in any way if unsure of the steps described here. In such cases, please contact your dealer immediately.

1. Prepare the necessary cables, adapter, power cord, LAN cable, etc.; do not connect the unit yet.
2. For MB5404D-X and MB5404D-Sis-X, plug in the Power Supply/Adapter to a power outlet. Note that these two models support redundant power supply through the 7-pin terminal block (located on top of the device) in which user can supply only one pair of 12VDC to either PWR1 (PIN2 & PIN3) or PWR2 (PIN6 & PIN7) or supply both pairs for redundancy. User has two options to connect G (PIN1) of the 7-pin terminal block or connect grounding screw (next to the 7-pin terminal block) to the grounding. It is required to connect either of these grounds at all times to ensure overall maximum performance. Shortly thereafter the unit will beep twice and both PWR and RUN LEDs turn green. Within one minute, the RUN LED shall start blinking which indicates that the AP firmware is running normally. For MB5408A / MB5416A / MB5408A2-N / MB5416A2-N Series, plug in the AC power cord to a power outlet and turn on the power switch. Please make sure the electrical outlet has proper grounding so as to not causing damage to the unit, property or yourself. Shortly thereafter the unit will beep once and the LCM Display will show a status of LAN1 interface. The first line of LCM Display will either show "LAN1:" or "LAN1: Link down" while the second line will shows an IP address of LAN1 interface. Within one minute, the buzzer shall beep once, and the LCM Display shall show the model's name.
3. Connect LAN1 port to a network switch or to your LAN with a UTP cable, and connect a host PC to your LAN with another UTP cable.
4. Connect a serial device to one of the serial ports, and make sure a correct cable is used (Pin assignments for RS-232, RS-422, and RS-485 cables are shown in Table 5.2 to Table 5.6)

For more information on how to install the device, please refer to the Hardware Installation Guide leaflet available in your package.

2.2 Factory Default Settings

Network Default Setting

Note that the Modbus Gateway comes with one IP address for redundant Ethernet interfaces.

Table 2.1 Default Network Setting

Interface	Device IP	Subnet mask	Gateway IP
LAN 1	10.0.50.100	255.255.0.0	10.0.0.254
LAN 2	192.168.1.1	255.255.255.0	192.168.1.254

Note: Default DNS 1 setting is 168.95.1.1 and DNS 2 setting is 0.0.0.0.

Modbus Default Settings

Table 2.2 Default Modbus Settings

Parameter	Default Values
Modbus Master	
TCP Settings	TCP Master <ul style="list-style-type: none"> ● Mode: TCP Master ● Port: 502
Modbus Slave	
<ul style="list-style-type: none"> ● MB5408A/MB5408A2-N:COM1 – COM8 ● MB5416A/MB5416A2-N:COM1 – COM16 ● MB5404D-X: COM1 – COM4 ● MB5404D-Sis-X: COM1 – COM4 	Mode: RTU Slave Serial Configuration: RS-232 (or RS-422 for MB5404D-Sis-X, MB5408A-S5 and MB5416A-S5 Series), 9600 bps, 8 data bits, None Parity bit, 1 stop bit, No Flow Control, Buffer Disabled,

Other default settings are shown in the following table:

Table 2.3 Other Default Settings

Parameter	Default Values
Security	
User Name	Admin
Password	Null (<i>blank</i>)
SNMP	
SysName of SNMP	0060E9-XXXXXX
SysLocation of SNMP	Location
SysContact of SNMP	Contact
SNMP	Disable (Unchecked)
Read Community	Public
Write Community	Private
SNMP Trap Server	0.0.0.0

Note: you can press the “**Reset**” button on the front panel for 5 seconds (see [Sec.3.10.8](#) and [Sec.3.11](#)), to restore the Modbus Gateway to the factory default settings.

3 Configuration and Setup

3.1 Locating and IP configuring using Serial Manager©

First, please install our configuration utility program called **Serial Manager©** that comes with the Product CD or can be downloaded from our websites (www.atop.com.tw or www.atop-tech.com). For more information on how to install **Serial Manager©**, please refer to the manual that comes in the Product CD. After you start the **Serial Manager©**, if the Modbus Gateway is already connected to the same subnet as your PC or can be accessed via broadcast packets, the **Serial Manager©** shall automatically detect your Modbus Gateway and list it on the Serial Manager©'s window. Alternatively, if you did not see your Modbus Gateway on your network, press “**Rescan**” icon, a list of devices including your Modbus Gateway device currently connected to the network will be shown in the window of **Serial Manager©** as shown in Fig. 3.1.

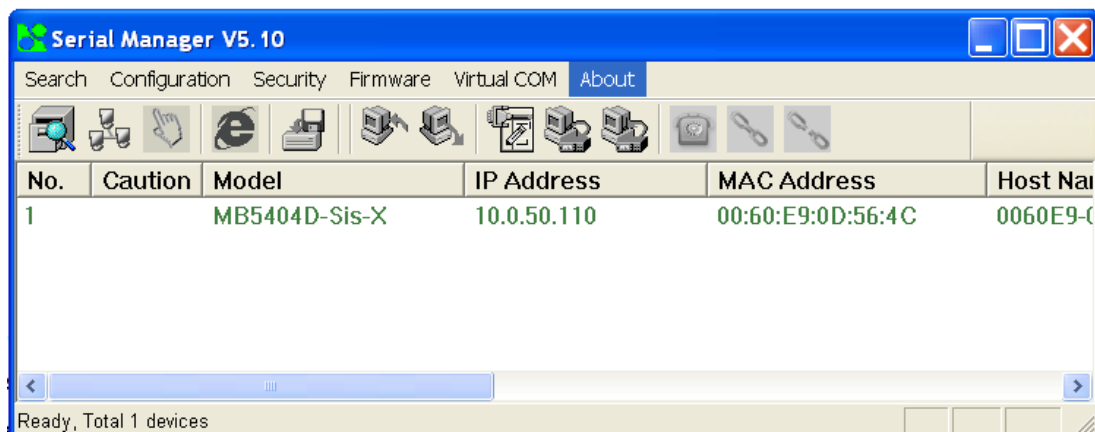

Fig. 3.1 List of Devices on Network in **Serial Manager©**

Note: This figure is for illustration purpose only. Actual values/settings may vary between devices.

Sometime the Modbus Gateway device might not be in the same subnet as your PC; therefore, you will have to use our utility to locate it in your virtual environment. To configure each device, click the selected device (default IP: 10.0.50.100) in the list of **Serial Manager©**, and click “**Configuration → Network...**” (or Ctrl+N) menu on **Serial Manager©** as shown in Fig. 3.2 or click on the second icon called **Network** on the menu bar, and a pop-up window will appear as

shown in Fig. 3.3.

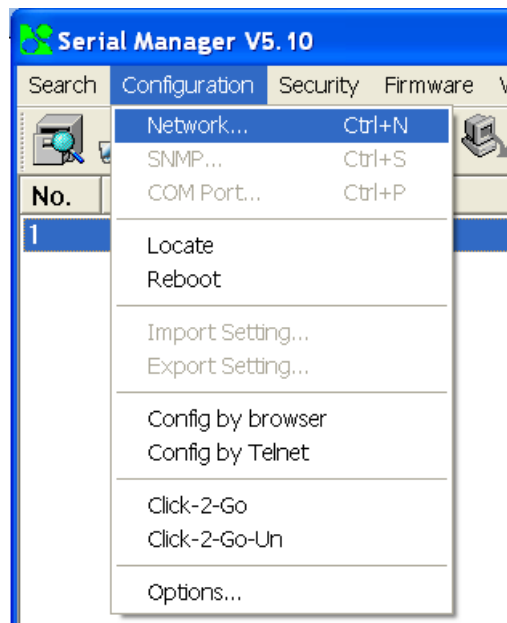

Fig. 3.2 Pull-down Menu of Configuration and Network...

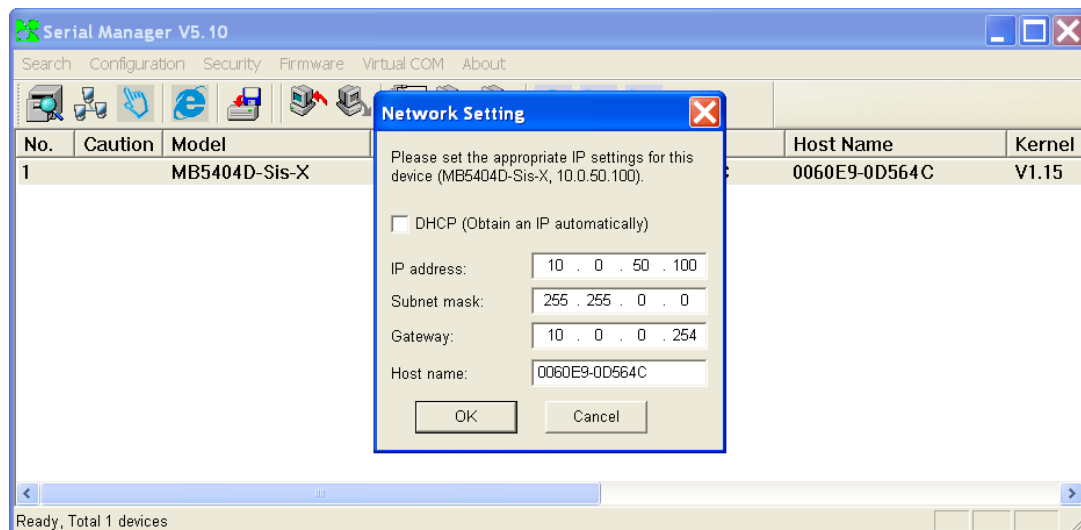

Fig. 3.3 Pop-up Window of Network Setting

You may proceed then to change the IP address to avoid any IP address conflict with other hosts on your LAN or to connect the device to your existing LAN as shown in Fig. 3.3. The system will prompt you for a credential to authorize the changes. That is it will ask you for the Username and the Password as shown in Fig. 3.4. The device will be restarted with a beep. After the device is restarted, it will beep twice to indicate that the unit is running normally. Then, the Modbus Gateway can be found on a new IP address. It may be listed automatically by the **Serial Manager**® along with its old record or it can be found by clicking on the **Rescan** icon.

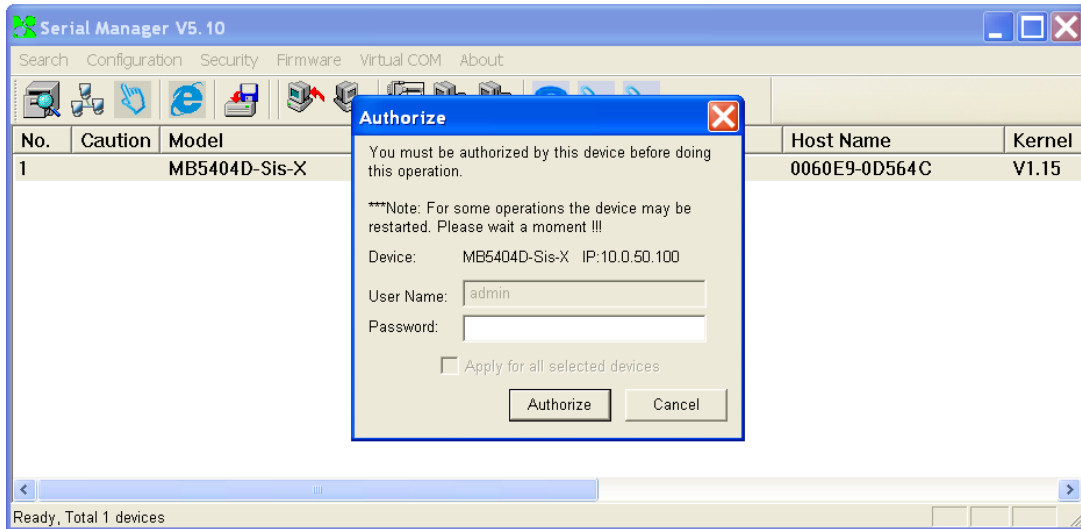

Fig. 3.4 Authorization for Changes

Please consult your system administrator if you do not know your network's subnet mask and gateway address. Note: If your LAN address begins with **192.168.X.X**, please use the LAN2 interface for configuration.

3.2 Configuring using Web Interface

Every MB5400 Modbus Gateway device is equipped with a built-in web server in the firmware. Therefore, it can be accessed by using a web browser for configuring by entering the device's IP address (default IP address is 10.0.50.100) in the URL field of your web browser. Fig. 3.5 illustrates the overview page of the web interface. Please see [Sec.2.4](#) for default values.



- Overview
- Network
- Basic Settings
- Advanced Settings
- Alert
- System
- Restart

OverView

The general device information of Modbus Gateway.

Model Name	MB5404D-Sis-X		
Device Information	Kernel	1.15	
	AP	4.34	
Network Information	Mode	Redundancy Mode	
	LAN (use LAN1 now)	MAC	00:60:E9:0D:56:4C
		IP	10.0.50.110

Fig. 3.5 Configuring Web Page of Modbus Gateway

Fig. 3.6 shows the expanded map of the configuring menu.

- Overview
- Network
- Basic Settings
 - COM Settings
 - VCOM Settings
 - TCP Settings
 - Slave ID Map
- Advanced Settings
 - SNMP Settings
 - Modbus
- Alert
 - SMTP Settings
 - Alert Events
- System
 - Log Settings
 - System Log
 - Data Log
 - Modbus Statistic
 - Time
 - Security
 - Import/Export
 - Factory Default
- Restart





Fig. 3.6 Map of Configuring Web Page on Modbus Gateway

This approach for configuring your device is the most user-friendly. It is the most recommended and the most common method used for MB5400 Modbus Gateways. Please go to its corresponding section for a detailed explanation.

3.3 LCM (Liquid Crystal Matrix) Configuration

This section only applies to the 8-Port and 16-Port devices. The device also has the option of manual configuration (without using any software) by making use of its interactive console. Using this method is however very easy and intuitive. Buttons and their functions are described next.

Table 3.1 LCM Button's Description

Buttons		Button Description
	<Menu>	Open Main Menu or go back one level higher
	<Up>	Scroll up
	<Down>	Scroll down
	<SEL>	Confirm the selection. When working with IP addresses, pressing <SEL> means moving to the next digit

Example

To change the device's IP address, follow the instruction below.

- Press **<Menu>** to enter **Main Menu**
- Press **<Down>** to scroll down to **2. Network Set**
- Press **<SEL>** to enter Network setting and then **<Up>/<Down>** to scroll up or down to **LAN1**
- Press **<SEL>** to enter **LAN1** and then **<Down>** to scroll down to **1. IP Config**
- Press **<SEL>** to enter **LAN1 IP Config** and then press **<Down>** to scroll down to **1. Static**, finally press **<SEL>** to save the selection.
- Press **<SEL><Down>** to enter **2. IP Address**. Use **<Up>/<Down>** to increase or decrease the **Digits of IP Address**, press **<Menu>** to return to one level higher after

completion.

- To enter: **3. Net mask**, use **<Up>/<Down>** to increase or decrease the digits of subnet mask and then **<Menu>** to return to one level higher after completion.
- To enter: **4. Gateway**, use **<Up>/<Down>** to increase the digits of default gateway and use **<Menu>** to return to one level higher after completion.
- Press **<SEL>** to the end of the menu to return to one level higher and the device shall display System message **"Save & Restart"**. Push **<SEL>** to **2. Yes**, and **<SEL>** again after completion. The device shall restart and the new settings will appear.

The LCM command structure is summarized in Table 3.2

Table 3.2 LCM Command Structure

1 st layer	2 nd layer	3 rd layer	4 th layer	Descriptions	
1.Overview	1. Model name			Display model name	
	2. Kernel ver.			Display kernel version	
	3. AP ver.			Display AP version	
	4. Lan 1		1.LAN status		Display status of LAN1
			2.MAC		Display MAC address of LAN1
	5. Lan 2		1.LAN status		Display status of LAN2
2.MAC				Display MAC address of LAN2	
2.Network set	1.Lan 1	1.IP config	1.Static IP	Display or change static IP	
			2.DHCP	Display dynamic IP or enable DHCP	
		2.IP address		Display or change LAN1 IP	
		3.Net mask		Display or change subnet mask	
	4.Gateway		Display or change the Gateway IP		
	2.DNS server1			Display or change 1st DNS IP address	
3.DNS server2			Display or change 2nd DNS IP address		
3.Serial set	1.Select port			Select COM Port: MB5408A / MB5408A2-N : [1]~[8] / MB5416A / MB5416A2-N : [1]~[16]	

1 st layer	2 nd layer	3rd layer	4 th layer	Descriptions
	2.Parameter set	1.Baud Rate	1. 300	Display or change baud rate
			2. 600	
			3. 1200	
			4. 2400	
			5. 4800	
			6. 9600	
			7. 19200	
			8. 38400	
			9. 57600	
			10. 115200	
			11. 230400	
			12. 460800	N/A in MB5404D-Sis-X
			13. 921600	N/A in MB5404D-Sis-X
		2.Parity	1. None	Display or change parity mode
			2. Odd	
			3. Even	
			4. Mark	
			5.Space	
		3.Data bits	1. 7 bits	Display or change data bits' length
			2. 8 bits	
		4.Stop bits	1. 1 bits	Display or change stop bits' length
			2. 2 bits	
		5.Flow control	1. None	Display or change flow control mode
			2. Software Xon/Xoff	
			3. Hardware RTS/CTS	

1 st layer	2 nd layer	3 rd layer	4 th layer	Descriptions		
		6.UART mode	1. 232	Display or change UART mode for RS-232		
			2. 422	Display or change UART mode for RS-422		
			3. 485	Display or change UART mode for RS-485		
		7.Apply to all	1.No			
			2.Yes	Apply UART setting to all serial ports		
		4.Server state	1.Console	1.Web console	1.Disable	Disable web console
					2.Enable	Enable web console
2.Telnet console	1.Disable			Disable telnet console		
	2.Enable			Enable telnet console		
2.Pwd protection	1.LCM console		1.No	Disable LCM console password protection		
			2.Yes	Enable and change the password		
	2.Reset button		1.No	Disable the reset button password protection		
			2.Yes	Enable and change the password on reset button		
3.Ping	1.Lan 1			Use "ping" command to check specific IP address for LAN1		
	2.Lan 2			Use "ping" command to check specific IP address for LAN2		
5.Restart	1.No			Cancel restart command		
	2.Yes			Restart immediately		

3.4 Configuring Automatic IP Assignment with DHCP

A DHCP server can automatically assign addresses to LAN1 or LAN2, the Subnet Mask, and the Gateway (your network gateway, not the Modbus Gateway). You can simply check “**DHCP (Obtain an IP Automatically)**” box in the Network Setting dialog using our **Serial Manager**® utility and then restart it. Once restarted, the IP address(es) will be automatically configured.

3.5 Web Overview

In this section, only current information on the device's status and settings will be displayed. An example of MB5416-X's overview page is shown in Fig. 3.7.

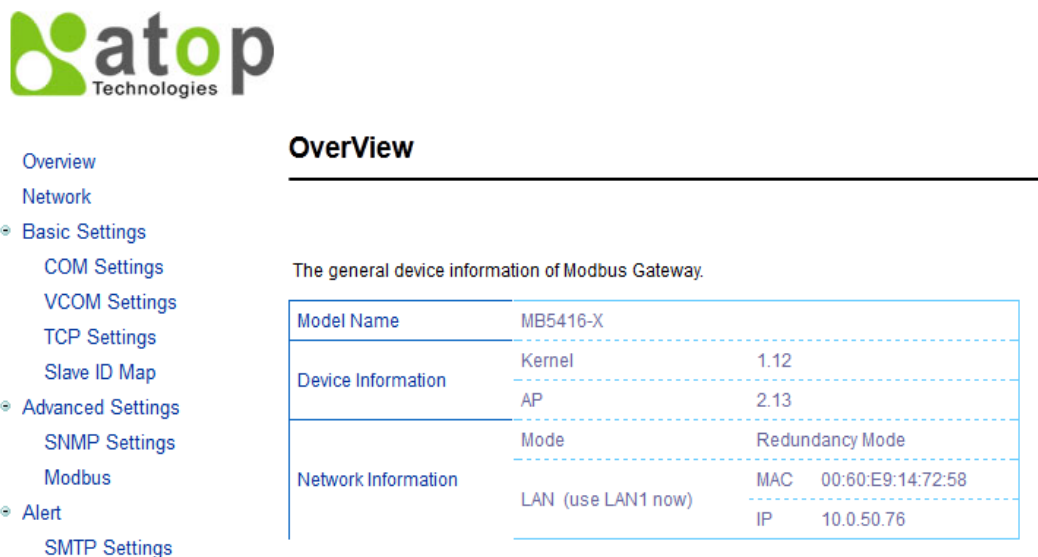

The screenshot shows the Atop Technologies logo on the left. Below it is a navigation menu with the following items: Overview, Network, Basic Settings (with sub-items: COM Settings, VCOM Settings, TCP Settings, Slave ID Map), Advanced Settings (with sub-items: SNMP Settings, Modbus), Alert (with sub-item: SMTP Settings). The main content area is titled 'OverView' and contains the text 'The general device information of Modbus Gateway.' followed by a table.

Model Name	MB5416-X		
Device Information	Kernel	1.12	
	AP	2.13	
Network Information	Mode	Redundancy Mode	
	LAN (use LAN1 now)	MAC	00:60:E9:14:72:58
		IP	10.0.50.76

Fig. 3.7 Overview Page

- **Model Name**, as its name implies, shows the device's model.
- **Device Information** displays information on the Kernel version as well as the AP version of your Modbus Gateway device.
- **Network Information** shows the Mode in which the Modbus Gateway device is currently operating on (Dual Subnet Mode or Redundancy Mode), and one of the used LAN for Redundancy Mode as shown in Fig. 3.7 or both LANs corresponding MAC and IP addresses for Dual Subnet mode.

- **Dual Subnet Mode:** Two Ethernet ports have separate IP addresses and subnets
- **Redundancy Mode:** The system will use only one port for data transfer. If the port is disconnected, the whole system will change to another port automatically.

3.6 Network Configuration

In this section, IP address, Subnet Mask, Default (Network) Gateway, Domain Name System (DNS) and overall connectivity settings can be accessed as shown in Fig. 3.8. For any LAN Settings, you can check the **DHCP** box to obtain an IP address, Subnet Mask, and Default (Network) Gateway automatically. When operating in **Redundancy Mode**, the Modbus Gateway device will have the two LAN ports connected¹ to the network, but the signal will flow through only one of them. If one port is out due to any reason, there will still be another route for the signal to keep on flowing.

Note¹: You can connect only one LAN port to the Modbus Gateway device and change the settings on this page. However, the **redundancy** function will no longer work.

atop
Technologies

Overview
 Network
 Basic Settings
 COM Settings
 VCOM Settings
 TCP Settings
 Slave ID Map
 Advanced Settings
 SNMP Settings
 Modbus
 Alert
 SMTP Settings
 Alert Events
 System
 Log Settings
 System Log
 Data Log
 Modbus Statistic
 Time
 Security
 Import/Export
 Factory Default
 Restart

NetWork

To configure network settings of Modbus Gateway. After saving configuration you have to restart the device to make the settings effective.

Redundancy Mode Dual Subnet Mode

LAN Settings	
DHCP	<input type="checkbox"/> Obtain an IP automatically
IP Address	10 . 0 . 50 . 76
Subnet Mask	255 . 255 . 0 . 0
Default Gateway	10 . 0 . 0 . 254

DNS Settings	
DNS 1	17 . 17 . 17 . 17
DNS 2	17 . 17 . 17 . 17

Save Configuration

Fig. 3.8 Network Configuration Page in Redundancy Mode

At the lower box in Fig. 3.8, you will have the DNS Settings box which allows you to set the IP addresses of Domain Name Server 1 (DNS 1) and Domain Name Server 2 (DNS 2) for redundancy. If your device is connected to the Internet and would like to connect to other servers over the Internet such as Network Time Protocol (NTP) server, you may need to configure these two IP addresses to be able to resolve the host name of the NTP server. You may consult you network administrator or internet service provider (ISP) to obtain your local DNS's IP addresses.

When the Modbus Gateway device is set in **Dual Subnet Mode** as shown in Fig. 3.9, a set of two IP addresses can be used without having any **redundancy**. This is especially useful when using two different networks. Note that you will have option to select (either one of two radio buttons) which LAN is the default interface in the **Default Gateway Select** box.



- Overview
- Network
 - Basic Settings
 - COM Settings
 - VCOM Settings
 - TCP Settings
 - Slave ID Map
 - Advanced Settings
 - SNMP Settings
 - Modbus
 - Alert
 - SMTP Settings
 - Alert Events
 - System
 - Log Settings
 - System Log
 - Data Log
 - Modbus Statistic
 - Time
 - Security
 - Import/Export
 - Factory Default
 - Restart

NetWork

To configure network settings of Modbus Gateway. After saving configuration you have to restart the device to make the settings effective.

Redundancy Mode
 Dual Subnet Mode

LAN 1 Settings				
DHCP	<input type="checkbox"/> Obtain an IP automatically			
IP Address	10	0	50	76
Subnet Mask	255	255	0	0
Default Gateway	10	0	0	254

LAN 2 Settings				
DHCP	<input type="checkbox"/> Obtain an IP automatically			
IP Address	192	168	1	1
Subnet Mask	255	255	255	0
Default Gateway	192	168	1	254

Default Gateway Select	
Default Gateway Select	<input checked="" type="radio"/> LAN1 <input type="radio"/> LAN2

DNS Settings				
DNS 1	17	17	17	17
DNS 2	17	17	17	17

Save Configuration

Fig. 3.9 Network Configuration Page in Dual Subnet Mode

After finishing configuring the network settings, please click on **Save Configuration** button to keep all changes that you have made. A **Save Successful** message will appear with a hyperlink to **restart** the device as shown in Fig. 3.10. Please click the **restart** hyperlink to apply the changes. Then, a message indicating **System Restarting** status with a counting down number will show up as shown in Fig. 3.11. After a successful Modbus Gateway device's restart, the web browser will be redirected to the Overview page as shown in Fig. 3.7.



- Overview
- Network
- Basic Settings
- Advanced Settings
- Alert
- System
- Restart

Save Successfully

You have to [restart](#) the device to make the settings effective.

Fig. 3.10 Save Successfully Page with a restart hyperlink



- Overview
- Network
- Basic Settings
- Advanced Settings
- Alert
- System
- Restart

System Restarting 34

Fig. 3.11 Counting Down Page

3.7 Basic Settings

In this section, we will use the term “**Modbus Gateway device**” to refer to the MB5400 series and the term “**serial device**” to refer to any Modbus device that connect to Modbus Gateway via COM, VCOM, or TCP connections. In any Modbus network, there are two types of Modbus devices: Modbus Master and Modbus Slave. The Modbus Master will send a request message to a Modbus Client. Then, the modbus client will respond to the Modbus master’s request. A Modbus device (serial device) that is connected to the MB5400 series Modbus Gateway device will either assume a role of Modbus Master or Modbus Slave. The basic settings in this section will address the way to configure this role of the serial device in your Modbus Gateway device and its serial communication parameters. We will use the term “**Operation Mode**” to refer to the combination of role (Master or Slave) and the message or data transfer types (RTU/ASCII/TCP) of the Modbus protocol used by the serial device.

3.7.1 COM Settings

This section is responsible for setting up your physical ports of your Modbus Gateway device which are COM ports or serial ports that serial devices are connected to. Note that the available number of COM ports may vary for different Modbus Gateway models. Fig. 3.12 depicts the COM Settings page in which COM 1 port is shown with its **Operation Mode** under **Modbus Setting** and **Serial Configuration** settings. Note that these settings will configure the role of the serial device through the **Operation Mode** and the serial communication parameters of that serial device through the **Serial Configuration** settings.



- Overview
- Network
- Basic Settings
 - COM Settings
 - VCOM Settings
 - TCP Settings
 - Slave ID Map
- Advanced Settings
 - SNMP Settings
 - Modbus
- Alert
 - SMTP Settings
 - Alert Events
- System
 - Log Settings
 - System Log
 - Data Log
 - Modbus Statistic
 - Time
 - Security
 - Import/Export
 - Factory Default
 - Restart

Basic Settings > COM Settings

To configure COM 1 port parameters.

Modbus Setting	
Operation Mode	ASCII Master
Serial Configuration	
Interface	<input checked="" type="radio"/> RS232 <input type="radio"/> RS422 <input type="radio"/> RS485
Baud Rate	9600 bps
Parity	<input checked="" type="radio"/> None <input type="radio"/> Odd <input type="radio"/> Even <input type="radio"/> Mark <input type="radio"/> Space
Data Bits	<input type="radio"/> 7 bits <input checked="" type="radio"/> 8 bits
Stop Bits	<input checked="" type="radio"/> 1 bit <input type="radio"/> 2 bits
Flow Control	<input checked="" type="radio"/> None <input type="radio"/> Xon/Xoff <input type="radio"/> RTS/CTS
<input type="checkbox"/> Apply To All Serial Ports	

Save Configuration

COM Number	Operation Mode	Interface	Baud Rate	Parity	Data Bits	Stop Bits	Flow Control
01	ASCII Master	RS232	9600	None	8	1	None
02	RTU Slave	RS232	9600	None	8	1	None
03	RTU Slave	RS232	9600	None	8	1	None
04	RTU Slave	RS232	9600	None	8	1	None
05	RTU Slave	RS232	9600	None	8	1	None
06	RTU Slave	RS232	9600	None	8	1	None

Fig. 3.12 COM Setting Page

3.7.2 Operation Mode

To setting the **Operation Mode** of your serial device that is connected to your Modbus Gateway through a COM port, please use the pull-down menu to select one of the following modes under **Modbus Setting**.

- **RTU Slave:** When a serial device is working as a Modbus slave node, the serial device will wait, accept request from, and response to its Modbus master node. Data transfer is done under a RTU format.
- **RTU Master:** When a serial device is working as a Modbus master node, the serial device will issue commands to or query Modbus slave nodes. Data transfer is done under a RTU format.
- **ASCII Slave:** When a serial device is working as a Modbus slave node, the serial device

will wait, accept request from, and response to its Modbus master node. Data transfer is done under an ASCII format.

- **ASCII Master:** When a serial device is working as a Modbus master node, the serial device will issue commands to or query Modbus slave nodes. Data transfer is done under an ASCII format.

3.7.3 Serial Settings

This section summarizes the options of serial communication parameters used between the serial device and the Modbus Gateway device over the selected COM port.

- RS-232/RS-422/RS-485 Software Selectable (RS-422/485 for MB5404D-Sis-X, MB5408A-S5 and MB5416A-S5 Series).
- Baud-rate: 300 bps ~ 921600 bps (Note that MB5404D-Sis-X's baud-rate is limited to 300 bps ~ 230400 bps)
- Parity: None, Odd, Even, Mark, or Space
- Data Bits: 7 or 8
- Stop Bits: 1 or 2
- Flow Control: None, Software Xon/Xoff, Hardware RTS/CTS

Apply to all Serial Ports: Alternatively, the settings can be chosen to apply to all serial ports if needed by checking the last box on the options.

After finish configuring the **COM Settings**, please click on **Save Configuration** button to keep all changes that you have made. A **Save Successfully** message will show up as shown in Fig. 3.13 and after a short period of time the web browser will be redirected back to **COM Settings** page.



Fig. 3.13 Save Successfully Message

3.7.4 VCOM Settings

These settings will generate a virtual Serial (VCOM) port within the Modbus Gateway device based on a TCP network connection. VCOM is a **TCP connection** which is encoded in an Atop Technologies' exclusive private protocol. Note that MB5400 series Modbus Gateway can only run as a TCP server which will be waiting for a connection request from a TCP client (a serial device).

Fig. 3.14 shows the page of VCOM Settings in which the VCOM number 1 is set as an RTU Slave. This means that a serial device that is connected to this VCOM port on the Modbus Gateway will be a Modbus slave node and communicate with a Modbus master node using Modbus/RTU protocol. If you need a VCOM setting, proceed to select **Basic Settings** → **VCOM Settings** and check the VCOM's "**Enable**" box to allow configuration on the selected TCP's port of the Modbus Gateway device.

- **VCOM Port:** Using a TCP connection, the Modbus Gateway device (TCP server) listens to whether there are any TCP clients (VCOM clients) connecting (using Serial-IP) to its ports. The VCOM Port or the port of the TCP connection can be configured as a number between 1 and 65535. The default VCOM Port number is 4660.

Note: For Windows operating system, a Serial/IP software is required to use this feature. A restrictive **Serial/IP Redirector** software is installed along with Atop's **Serial Manager**®. The user can access the Serial/IP software through **Virtual COM** → **Serial/IP Tools** menu.



- Overview
- Network
- Basic Settings
 - COM Settings
 - VCOM Settings
 - TCP Settings
 - Slave ID Map
- Advanced Settings
- Alert
- System
- Restart

Basic Settings > VCOM Settings

To configure VCOM parameters.

VCOM	<input checked="" type="checkbox"/> Enable
VCOM Port	<input type="text" value="4660"/> (1~65535, default=4660)
VCOM Mode	<input type="text" value="RTU Slave"/>
VCOM Inactivity Time Out	<input type="text" value="0"/> (0~36000 seconds)
<input type="checkbox"/> Apply to All VCOMs	

Fig. 3.14 VCOM Settings Page

- **VCOM Mode:** This setting is a pull-down menu in which the user can select the **Operation Mode** of the serial device connected through this VCOM port as shown in Fig. 3.15. Its definition is analogous to the one in 3.7.2. Here you can choose whether your serial device conforms to a RTU or an ASCII message format and can select whether your serial device is a Modbus slave node or a Modbus master node. Fig. 3.14 depicts the **RTU Slave** mode which means that a serial device connected through VCOM 1 port will assume a Modbus slave role and communicate using Modbus/RTU protocol. However, if a master mode (either RTU or ASCII) is selected, the options for the master mode will be the same as the slave mode. The only difference is the serial device's function.



- Overview
- Network
- Basic Settings
 - COM Settings
 - VCOM Settings
 - TCP Settings
 - Slave ID Map
- Advanced Settings
- Alert
- System
- Restart

Basic Settings > VCOM Settings

To configure VCOM parameters.

VCOM	<input checked="" type="checkbox"/> Enable
VCOM Port	<input type="text" value="4660"/> (1~65535, default=4660)
VCOM Mode	<input type="text" value="RTU Slave"/> <input type="button" value="v"/> <ul style="list-style-type: none">RTU SlaveRTU MasterASCII SlaveASCII Master
VCOM Inactivity Time Out	<input type="text" value="0"/> (0~36000 seconds)
<input type="checkbox"/> Apply to All VCOMs	

Fig. 3.15 Pull-down Menu of VCOM Mode

- **VCOM inactivity Time Out:** This is a period of time allowed between actions. This setting can be set with a maximum of 600 minutes (36000 seconds) or 10 hours. If there is no activity within this period, the VCOM connection (TCP connection) will be automatically closed by the Modbus Gateway.

It is important to note that alternatively these settings can be chosen to apply to All VCOMs if needed by checking the last box on the options. Fig. 3.16 highlights the check box for applying the settings to all VCOMs.



- Overview
- Network
- Basic Settings
 - COM Settings
 - VCOM Settings
 - TCP Settings
 - Slave ID Map
- Advanced Settings
- Alert
- System
- Restart

Basic Settings > VCOM Settings

To configure VCOM parameters.

VCOM	<input checked="" type="checkbox"/> Enable
VCOM Port	<input type="text" value="4660"/> (1~65535, default=4660)
VCOM Mode	<input type="text" value="RTU Slave"/> <input type="button" value="v"/>
VCOM Inactivity Time Out	<input type="text" value="0"/> (0~36000 seconds)
<input checked="" type="checkbox"/> Apply to All VCOMs	

Fig. 3.16 Check Box for Applying the Setting to All VCOMs

After finishing configuring the **VCOM Settings**, please click on **Save Configuration** button to keep all changes that you have made. After a **Save Successfully** message showed up, the web browser will be redirected back to the **VCOM Settings** page.

3.7.5 TCP Settings

A serial device using Modbus/TCP connection, which communicates over the internet, can be set in this section. If you need a Modbus/TCP connection, first go to **Basic Settings** → **TCP Settings**, then proceed to choose whether to enable **TCP** by checking on the “**Enable**” check box. Fig. 3.17 illustrates the Modbus TCP Settings page in which a serial device connected to this Modbus Gateway device is chosen to be run in **TCP Slave Operation Mode**. This means that the serial device will assume the Modbus slave role and communicate using Modbus/TCP protocol.



Basic Settings > TCP Settings

To configure TCP 1 parameters.

Add New Modbus TCP					
TCP	<input checked="" type="checkbox"/>	Enable			
Operation Mode	<input checked="" type="radio"/>	TCP Slave	<input type="radio"/>	TCP Master	
Remote IP Address	<input type="text" value="10"/>	<input type="text" value="0"/>	<input type="text" value="34"/>	<input type="text" value="2"/>	
TCP Port	<input type="text" value="502"/>	(1~65535, default=502)			
TCP Inactivity Time Out	<input type="text" value="0"/>	(0~36000 seconds)			

<input type="checkbox"/>	TCP No.	Operation Mode	Remote IP Address	TCP Port	Inactivity Time Out
<input type="checkbox"/>	01	TCP Slave	10.0.34.2	502	0 seconds
<input type="checkbox"/>	16	TCP Master		502	0 seconds

Fig. 3.17 Modbus TCP Setting Page with TCP Slave Mode

- Operation Mode:** There are two radio buttons in this setting: TCP Slave and TCP Master. When running on TCP slave mode (the TCP Slave radio button is checked) as shown in Fig. 3.17, the serial device will wait to receive Modbus requests from a Modbus Master. The data transmission is done under a Modbus/TCP protocol format. This means that the serial device will operate as a TCP server (under TCP protocol) that opens its TCP port to accept connections. We will describe the TCP Master option at the end of this section.

- **Remote IP Address:** This setting shows the IP address of the serial device which is a Modbus slave node. This address refers to the IP address that belongs to the serial device that is going to be controlled from your MB5400 Series. Note that this serial device can also be considered as a TCP server in which we need to know its IP address. This option will disappear when you select the operation mode as TCP Master because in that mode the serial device will be running as a TCP client which does not require to publish its IP address.
- **TCP Port:** This setting shows the TCP port number of the serial device (or Modbus slave node in Fig. 3.17) which can be a number in between 1 and 65535. The default port number is 502.
- **TCP inactivity Time Out:** A time out period, which is the period of time allowed between actions, can be set as well. This setting has a maximum duration of 600 minutes (36000 seconds) or 10 hours. If no activity has occurred within this period, the Modbus/TCP connection will be automatically terminated by the Modbus Gateway.

At the end of the **TCP Settings** page as shown in Fig. 3.17, there is a list of all configured Modbus/TCP connections with TCP No., Operation Mode, Remote IP Address, TCP Port and TCP Inactivity Time Out information. User will have the ability to remove any Modbus/TCP connection settings by checking on box in front of the record of the desired TCP settings and clicking on the **Remove** button. To remove all TCP connections, simply check the box on the header row of the list to select all items and click remove.

Alternatively, the Modbus/TCP connection can be configured to run in **TCP Master Operation Mode**. This means that the serial device will be a Modbus master node and communicate using Modbus/TCP protocol. Fig. 3.18 shows the TCP Master Settings. When select the **TCP Master Operation Mode**, the **Remote IP address** setting will disappear because the serial device will be running as a TCP client. Next, the **TCP Port** is the port through which the signal is going to be relayed upon by the Modbus Gateway. Once again, there is a **TCP Inactivity Time Out** with the same maximum value of 10 hours as stated in the previous mode.



- Overview
- Network
- Basic Settings
 - COM Settings
 - VCOM Settings
 - TCP Settings
 - Slave ID Map
- Advanced Settings
- Alert
- System
 - Restart

Basic Settings > TCP Settings

To configure TCP parameters.

Add New Modbus TCP	
TCP	<input checked="" type="checkbox"/> Enable
Operation Mode	<input type="radio"/> TCP Slave <input checked="" type="radio"/> TCP Master
TCP Port	<input type="text" value="502"/> (1~65535, default=502)
TCP Inactivity Time Out	<input type="text" value="0"/> (0~36000 seconds)

Fig. 3.18 Modbus TCP Setting Page with TCP Master Operation Mode Selection

After finishing configuring the **TCP Settings**, please click on **Save Configuration** button to keep all changes that you have made. After a **Save Successfully** message showed up, the web browser will be redirected back to the **TCP Settings** page.

3.7.6 Slave ID Map

The system uses the Modbus ID to route Modbus' request commands from a Modbus master node to a respective Modbus slave node. It is important to define ID mapping for each Modbus slave node. For every Modbus slave node, there must be a correct Virtual ID (Alias ID) and Real ID defined in the mapping. Fig. 3.19 shows the Slave ID Map settings. To configure Slave 1's parameters, check the **Enable** box to enable slave. Then, select the corresponding slave interface.

- **Slave Interface:** When a port is set to Modbus slave mode, a slave interface will be created for you. Select a radio button of a port number behind the **Slave Interface**, which can be any one of the listed **COM/VCOM/TCP ports**.
- **Slave ID Setting Mode:** Next, select either **Alias Mode** or **Offset Mode** to modify the slave ID setting as you needed.
 - **Alias Mode** maps a virtual ID to a real ID, one at the time. Fig. 3.19 depicts Slave ID settings of an **Alias Mode** with **Alias ID = 8** and **Real ID = 16**.
 - **Alias ID** refers to a Virtual ID for the reading Master node.
 - **Real ID** is the real ID from the slave node.

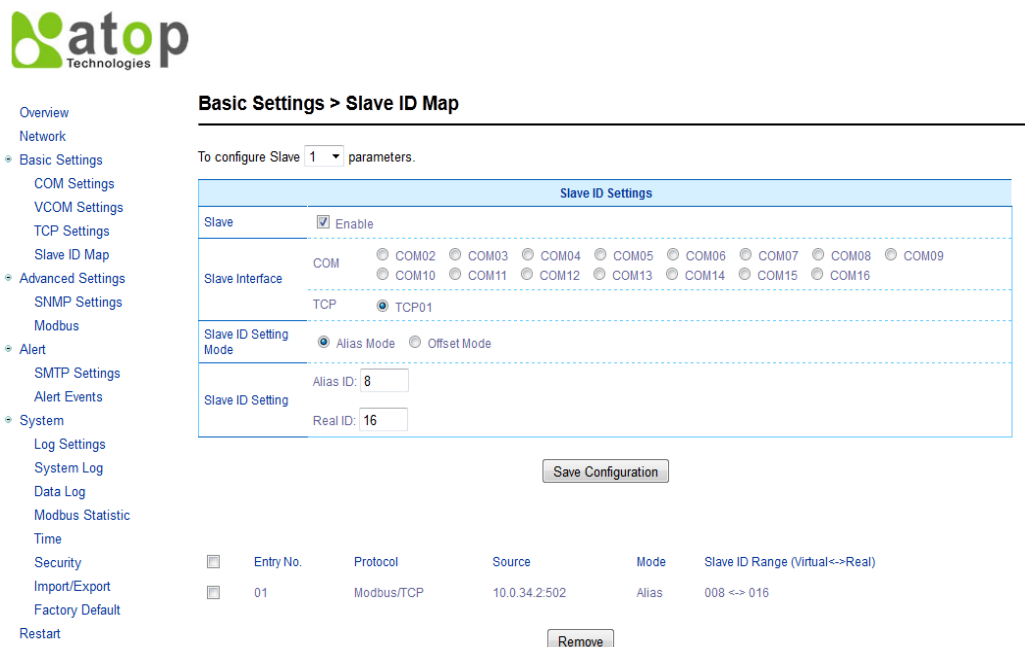

Fig. 3.19 Slave ID Map Page with Slave ID Setting in Alias Mode

- **Offset Mode** refers to a range of defined ID maps. Fig. 3.20 depicts Slave ID settings of an **Offset Mode** with **Slave ID Start = 8**, **Slave ID End = 16**, and **Slave ID Offset = 0**.

- **Slave ID Start** is a Virtual ID's start number.
- **Slave ID End** is a Virtual ID's end number.
- **Slave ID Offset** of a Real ID range, which is from (Slave ID Start - Offset) to (Slave ID End - Offset).



- Overview
- Network
- Basic Settings
 - COM Settings
 - VCOM Settings
 - TCP Settings
 - Slave ID Map
- Advanced Settings
 - SNMP Settings
- Modbus
- Alert
 - SMTP Settings
 - Alert Events
- System
 - Log Settings
 - System Log
 - Data Log
 - Modbus Statistic
 - Time
 - Security
 - Import/Export
 - Factory Default
 - Restart

Basic Settings > Slave ID Map

To configure Slave 1 parameters.

Slave ID Settings

Slave Enable

Slave Interface COM COM02 COM03 COM04 COM05 COM06 COM07 COM08 COM09 COM10 COM11 COM12 COM13 COM14 COM15 COM16

TCP TCP01

Slave ID Setting Mode Alias Mode Offset Mode

Slave ID Start:

Slave ID End:

Slave ID Offset:

<input type="checkbox"/>	Entry No.	Protocol	Source	Mode	Slave ID Range (Virtual<->Real)
<input type="checkbox"/>	01	Modbus/TCP	10.0.34.2:502	Alias	008 <-> 016

Fig. 3.20 Slave ID Map Page with Slave ID Setting in Offset Mode

Note: Master and Slave IDs can be set on COM, VCOM, and TCP. However, COM and VCOM work only with serial ports while TCP operates via Ethernet ports.

After finishing configuring the **Slave ID Map Settings**, please click on **Save Configuration** button to keep all changes that you have made. After a **Save Successfully** message showed up, the web browser will be redirected back to the **Slave ID Map Settings** page.

Below the **Slave ID Settings** box, there is a list of mapping entries as shown in Fig. 3.20 in which each line will summarize an **Entry No.**, a Modbus **Protocol**, a **Source** IP address, a Slave ID Setting **Mode**, and the **Slave ID Range (Virtual <-> Real)**. You can check the box in front of each entry to select that entry. Then, click **Remove** button to remove that particular entry from the **Slave ID Map**. To remove all entries, check on the box in front of the header line and click **Remove** button.

3.8 Advanced Settings

3.8.1 SNMP Settings

SNMP (Simple Network Management Protocol) Settings determines whether your device settings can be viewed with standard SNMP software. By default, it is disabled. Fig. 3.21 shows the **SNMP Settings** page.

- **SysName**, which is by default, is the MAC address of the Modbus Gateway.
- **SysLocation** refers to the device's physical location.
- **SysContact** is the device administrator's contact information.

If you wish to make the information available for public viewing by an SNMP Read Community string (a user ID or password), simply check the **"Enable SNMP"** box and fill in **"Public_viewers"** or your desired password string (the default string is **"public"**) in the **Read Community** field. If you wish to allow a group of people called **"Power_users"** to change the information, enter **"Power_users"** or your desired password string (the default string is **"private"**) in the **Write Community** field. If you allow a trap server to collect device information, please fill in **SNMP Trap Server** with its corresponding IP address (a trap server is designed to collect all alarm information from the Modbus Gateway). After finishing configuring the SNMP Settings, please click on **Save Configuration** button to keep all changes that you have made. Note that configuration will take effect after the device is restarted by clicking on the restart link as shown in Fig. 3.10. After a successful device's restart, the web browser will be redirected to the Overview page as shown in Fig. 3.7.



- Overview
- Network
- Basic Settings
 - COM Settings
 - VCOM Settings
 - TCP Settings
 - Slave ID Map
- Advanced Settings
 - SNMP Settings
 - Modbus
- Alert
 - SMTP Settings
 - Alert Events
- System
 - Log Settings
 - System Log
 - Data Log
 - Modbus Statistic
 - Time
 - Security
 - Import/Export
 - Factory Default
 - Restart

Advanced Settings > SNMP Settings

By enabling SNMP you allow the management utility to collect the information of Modbus Gateway. You can change the device network identity as well by changing the system name, location and contact.

SNMP Settings	
SysName	<input type="text" value="0060E9-147258"/>
SysLocation	<input type="text" value="location"/>
SysContact	<input type="text" value="contact"/>
SNMP	<input type="checkbox"/> Enable
Read Community	<input type="text" value="public"/>
Write Community	<input type="text" value="private"/>
SNMP Trap Server	<input type="text" value="0"/> . <input type="text" value="0"/> . <input type="text" value="0"/> . <input type="text" value="0"/>

Fig. 3.21 SNMP Settings Page

3.8.2 Modbus

In **Modbus** settings, you could select whether to enable **Modbus Exception** by checking the **Enable** box as shown in Fig. 3.22. If the Modbus slave returns no response and timeout occurs, it may then be necessary for the gateway to return an exception. To set **Response Timeout** for COM and TCP/VCOM, please fill in the timeout periods in the following fields as shown in Fig. 3.22. Note that you can apply the timeout setting to all COM ports by checking the **Apply to All Coms** box.

- Configure timeout for each COM port between 10ms to 120000ms with a default value of 1000ms.
- Configure timeout for TCP/VCOM port between 10ms to 120000ms with a default value of 1000ms.

After finishing configuring the Advanced Modbus Settings, please click on **Save Configuration** button to keep all changes that you have made. After a **Save Successfully** message showed up, the web browser will be redirected back to the **Modbus** page.



- Overview
- Network
- Basic Settings
 - COM Settings
 - VCOM Settings
 - TCP Settings
 - Slave ID Map
- Advanced Settings
 - SNMP Settings
 - Modbus
- Alert
 - SMTP Settings
 - Alert Events
- System
 - Log Settings
 - System Log
 - Data Log
 - Modbus Statistic
 - Time
 - Security
 - Import/Export
 - Factory Default
- Restart

Advanced Settings > Modbus

Modbus Settings	
Modbus Exception	<input type="checkbox"/> Enable

Response Timeout	
COM 1	1000 (10-120000ms Default:1000ms)
<input type="checkbox"/> Apply to All Coms	
TCP/VCOM	1000 (10-120000ms Default:1000ms)

Fig. 3.22 Advanced Modbus Settings of Response Timeout for Modbus Exception

3.9 Alert Configuration

3.9.1 SMTP and E-mail Settings

When enabled, an E-mail alert would be sent to the designated E-mail addresses in the **E-Mail Settings**. To setup an email alert function, you first need to configure the **sender's E-mail address**, the **receiver's E-mail addresses** (up to three receivers), and the mail server configuration as shown in Fig. 3.23. Under the **Mail Server** settings, please fill in the IP address or host name of a **Mail Server**. Note to be able to resolve a host name properly, you need to configure DNS server in [Sec.3.6](#). If an authentication is required for the mail server, please check on the **Mail Server Authentication Required** box and fill in the **User Name** and the **Password** fields. After finishing configuring the SMTP and E-mail Settings, please click on **Save Configuration** button to keep all changes that you have made. After a **Save Successfully** message showed up, the web browser will be redirected back to the **SMTP Settings** page. You can also send a test E-mail from the Modbus Gateway by clicking on the **Send Test Mail** button. A pop-up window will notify the user of the result of test mail. If there is a problem such as "Test sending mail fail", please re-check the entered information of your **Mail Server**, **User Name** and **Password** or check your network connection to the **Mail Server**.



- Overview
- Network
- Basic Settings
 - COM Settings
 - VCOM Settings
 - TCP Settings
 - Slave ID Map
- Advanced Settings
 - SNMP Settings
 - Modbus
- Alert
 - SMTP Settings
 - Alert Events
- System
 - Log Settings
 - System Log
 - Data Log
 - Modbus Statistic
 - Time
 - Security
 - Import/Export
 - Factory Default
 - Restart

Alert > SMTP Settings

To configure the SMTP server where the E-mail notification will be sent.

E-mail Setting	
Sender's E-mail Address	<input type="text"/>
Receiver's E-mail Address 1	<input type="text"/>
Receiver's E-mail Address 2	<input type="text"/>
Receiver's E-mail Address 3	<input type="text"/>

Mail Server	
Mail Server	<input type="text"/>
<input type="checkbox"/> Mail Server Authentication Required.	
User Name	<input type="text"/>
Password	<input type="text"/>

Fig. 3.23 SMTP Settings Page

3.9.2 Alert Events

In **Alert Events** settings, you can configure options to have your Modbus Gateway sending out device information to alert users, administrators, or responsible personnel as shown in Fig. 3.24. There are five anomalies defined on this page that can trigger alert functions (by checking the corresponding **E-mail** boxes), which are:

- **Cold Start** is an event when power supply is interrupted,
- **Warm Start** is an event when the device Restart function is used either by pressing a button or by its interface,
- **Authentication Fail** is an event when incorrect username and password are entered,
- **IP address change** is an event when the device's IP address is changed,
- **Password Changed** is an event when the authentication password is changed.



- Overview
- Network
- Basic Settings
 - COM Settings
 - VCOM Settings
 - TCP Settings
 - Slave ID Map
- Advanced Settings
 - SNMP Settings
 - Modbus
- Alert
 - SMTP Settings
 - Alert Events
- System
 - Log Settings
 - System Log
 - Data Log
 - Modbus Statistic
 - Time
 - Security
 - Import/Export
 - Factory Default
 - Restart

Alert > Alert Events

To configure the Modbus Gateway to send alert by E-mail or trap.

Alert Event		
Cold Start	<input type="checkbox"/> E-mail	<input type="checkbox"/> Trap
Warm Start	<input type="checkbox"/> E-mail	<input type="checkbox"/> Trap
Authentication Failure	<input type="checkbox"/> E-mail	<input type="checkbox"/> Trap
IP Address Changed	<input type="checkbox"/> E-mail	
Password Changed	<input type="checkbox"/> E-mail	
LAN1 Link Down	<input type="checkbox"/> Relay Out	
LAN2 Link Down	<input type="checkbox"/> Relay Out	

Save Configuration

Fig. 3.24 Alert Events Settings Page

You can also set an SNMP trap by checking the **Trap** box for each of the first three anomalies above, which will send out alerts to an SNMP Trap Server. Note that to configure **SNMP Trap Server** please see [Sec.3.8.1](#).

For MB5408A, MB5416A, MB5408A2-N and MB5416A2-N models, there is a relay output installed on the Modbus Gateway as shown on the device's rear panel. The Modbus Gateway can change the state of the relay when any of the following two connection outage events occur:

- **LAN1 Link Down**
- **LAN2 Link Down**

The user can choose to connect to either normally close (NC) or normally open (NO) pins on the device's rear panel. When the **Relay Out** check box of either one of the LAN status is checked, it will trigger a state change through the **RELAY OUTPUT** when the corresponding outage event occurs. An LED will also be on to indicate the status of the relay output.

After finishing configuring the **Alert Events** settings, please click on **Save Configuration** button to keep all changes that you have made. After a **Save Successfully** message showed up, the web browser will be redirected back to the **Alert Events** page.

3.10 System

3.10.1 Log Settings

This section allows you to change the way to report your Log. You can save your Log Event to flash memory of Modbus Gateway by checking the **Enable Log Event to Flash** box. To specify the detail of your Log, you can select different **Log Level** by changing the pull-down menu of the **Log Level**. Note that there are four log levels available on the menu which are **Level 3: (LOG_ERR)**, **Level 4: (LOG_WARNING)**, **Level 6: (LOG_INFO)**, and **Level 7: (LOG_DEBUG)**. Fig. 3.25 shows a selection of **Log Level 4** which will keep **LOG_WARNING**.

Additionally, you may want to save you Log on a Syslog Server in your network. This can be enabled by checking the **Enable Syslog Server** box. Then, you need to specify the **Syslog Server IP** address and the **Syslog Server Service Port** (Note that the default port number is 514). After finishing changing the Log Settings, please click on **Save** button to keep all changes that you have made. The web browser will be redirected back to the **Alert Events** page after a **Save Successfully** message showed up.

atop
Technologies

System > Log Settings

Enable Log Event To Flash	<input type="checkbox"/>
Log Level	4: (LOG_WARNING) ▾
Enable Syslog Server	<input type="checkbox"/>
Syslog Server IP	0 . 0 . 0 . 0
Syslog Server Service Port	514 (1~65535, default=514)

Save

Fig. 3.25 Log Setting Page

3.10.2 System Log

This section merely shows a list of current system events with every event's properties displayed (**Date, Time, Startup Time, Level, and Event**). Fig. 3.26 shows an empty **System Log** page. You can navigate through the system log by either going directly to the last page by clicking on **Last Page** button or going to the next page by clicking on **Next Page** button. You will also have the option to show all events by clicking on **Show All Event** button as well as the option to clear them all by clicking on **Clear All Event** button.

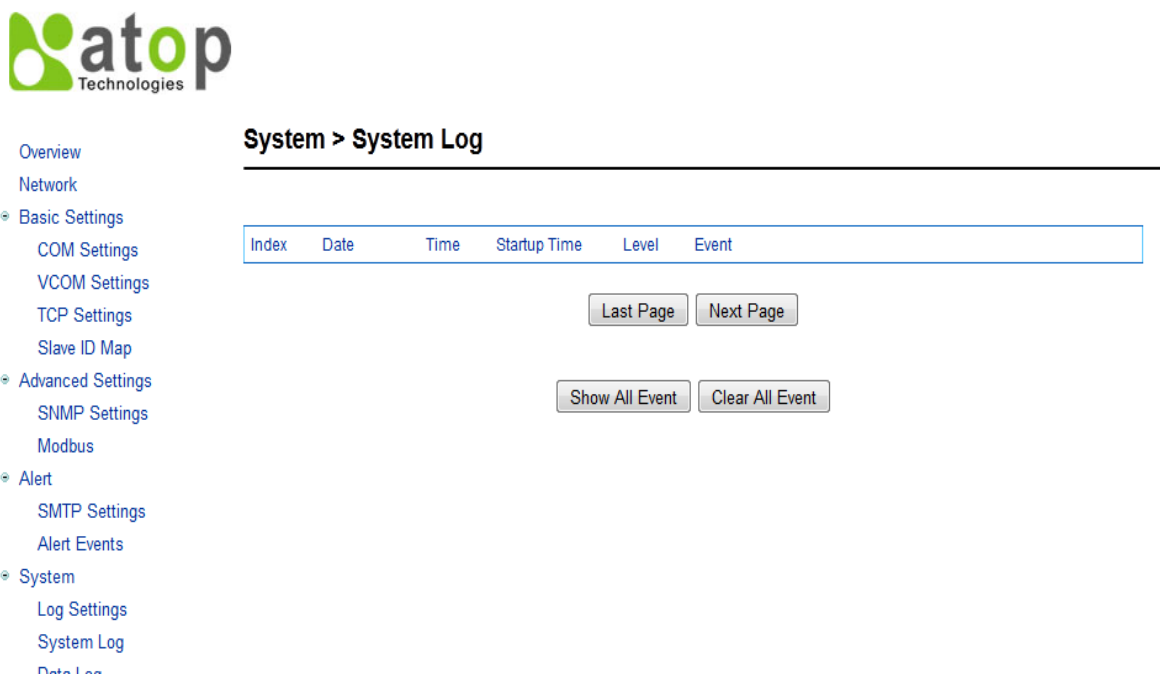

Fig. 3.26 System Log Page

3.10.3 Data Log

The log of Modbus's exchanged messages is shown in this **Data Log** section and listed in Fig. 3.27. You can select a radio button to show **All** properties or **Slave ID Only** or **Function Code Only**. **Event filtering** is also available in this section for your customized data analysis by entering your filter keyword in the **Filter Info** field and then click **Apply** button. Traffic analysis in the system can be done here as well. You can click on the **Start** button to enable continuously collecting of data log or click **Stop** button to end the data log collection. Finally, you can clear all data log by clicking on **Clear** button. Additionally, you will be able to browse through the list of message by clicking on the **Last Page** or the **Next Page** buttons at the bottom of the log table.

All
 Slave ID Only
 Function Code Only

Filter Info:

Index	Time	Type	Slave ID	Function Code	Event
1/1531	00:22:29	TCP Resp.	8	0x03	04 38 00 00 00 17 08 03 14 00
2/1531	00:22:29	RTU Req.	16	0x03	10 03 14 00 A3 F7
3/1531	00:22:29	RTU Req.	16	0x03	10 03 14 00 00 00 00 00 00 00 00 00 00 00 00
4/1531	00:22:28	TCP Resp.	8	0x03	04 37 00 00 00 17 08 03 14 00
5/1531	00:22:28	RTU Req.	16	0x03	10 03 14 00 A3 F7
6/1531	00:22:28	RTU Req.	16	0x03	10 03 14 00
7/1531	00:22:27	TCP Resp.	8	0x03	04 36 00 00 00 17 08 03 14 00
8/1531	00:22:27	RTU Req.	16	0x03	10 03 14 00 A3 F7
9/1531	00:22:27	RTU Req.	16	0x03	10 03 14 00 00 00 00 00
10/1531	00:22:26	TCP Resp.	8	0x03	04 35 00 00 00 17 08 03 14 00

Fig. 3.27 Data Log Page

3.10.4 Modbus Statistics

All Modbus's interface statistics are reported in this section as shown in Fig. 3.28. For each interface, there will be a **Net_Connection** or socket which is an IP address together with its port number (only for TCP and VCOM interfaces), a **Data Type** of the interface (**ASCII**, **RTU**, or **TCP**), a **Mode** of the Interface (either **MASTER** or **SLAVE**), the count of received messages (**RxCnt**), the received bytes (**RxByte**), the count of transmitted message (**TxCnt**), and the transmitted bytes (**TxByte**). You can click on the **Refresh** button to obtain the latest statistics of the Modbus's interfaces.



System > Modbus Statistic

Refresh

Interface	Net_Connection	Data Type	Mode	RxCnt	RxByte	TxCnt	TxByte
COM01		ASCII	MASTER	009913	0000168521	009912	0000227976
COM02		RTU	SLAVE	000000	0000000000	000000	0000000000
COM03		RTU	SLAVE	000000	0000000000	000000	0000000000
COM04		RTU	SLAVE	000000	0000000000	000000	0000000000
COM05		RTU	SLAVE	000000	0000000000	000000	0000000000
COM06		RTU	SLAVE	000000	0000000000	000000	0000000000
COM07		RTU	SLAVE	000000	0000000000	000000	0000000000
COM08		RTU	SLAVE	000000	0000000000	000000	0000000000
COM09		RTU	SLAVE	000000	0000000000	000000	0000000000
COM10		RTU	SLAVE	000000	0000000000	000000	0000000000
COM11		RTU	SLAVE	000000	0000000000	000000	0000000000
COM12		RTU	SLAVE	000000	0000000000	000000	0000000000
COM13		RTU	SLAVE	000000	0000000000	000000	0000000000
COM14		RTU	SLAVE	000000	0000000000	000000	0000000000
COM15		RTU	SLAVE	000000	0000000000	000000	0000000000
COM16		RTU	SLAVE	000000	0000000000	000000	0000000000
TCP	10.0.34.2:502	TCP	SLAVE	009912	0000287448	009913	0000059478
TCP(502)	0.0.0.0:502	TCP	MASTER	000000	0000000000	000000	0000000000

Fig. 3.28 Modbus Interface Statistics Page

3.10.5 Time

Date and time can be set manually or use **Network Time Protocol (NTP)** to automatically synchronize date and time of the Modbus Gateway with a **Time Server**. Fig. 3.29 shows the **Time** setting page. You can obtain the **Current System Time** by clicking on the **Refresh** button. Under the **System Time Setting** box, you can set the **Time Zone** by selecting your current time zone from the pull-down menu. Then, to choose the options of time setting, select the corresponding radio buttons of either **NTP** or **Manual**. For auto-synchronization, check the radio button in front of **NTP** option. Then, proceed to fill the IP address or hostname of your preferred time server such as time.nist.gov which is the default setting. Note that if the hostname is entered, the DNS server must be configured properly in [Sec.3.6](#). Other options will be greyed out if you select the **NTP** option.



- Overview
- Network
- Basic Settings
 - COM Settings
 - VCOM Settings
 - TCP Settings
 - Slave ID Map
- Advanced Settings
 - SNMP Settings
 - Modbus
- Alert
 - SMTP Settings
 - Alert Events
- System
 - Log Settings
 - System Log
 - Data Log
 - Modbus Statistic
 - Time
 - Security
 - Import/Export
 - Factory Default
- Restart

System > Time

By enabling NTP you allow to adjust and set the device internal time, relative to Greenwich Mean Time.

Current System Time	
2000/1/3 Mon 05:58:23	<input type="button" value="Refresh"/>

System Time Setting	
Time Zone	(GMT) Greenwich Mean Time: Dublin, Edinburgh, Lisbon, London
Time Setting	<input checked="" type="radio"/> NTP <input type="radio"/> Manual
NTP Setting	
NTP Server	time.nist.gov
Manual Setting	
Date	Year: 2000 / Month: Jan / Day: 3
Time	Hour:(0~23): 5 / Minute:(0~59): 58 / Second:(0~59): 23
Daylight Saving Setting	
<input type="checkbox"/> Enable Daylight Saving Time	
Start Date	Month: Jan / Week: 1st / Day: Sun / Hour: 1
End Date	Month: Jan / Week: 1st / Day: Sun / Hour: 1
Offset	1 hour(s)

Fig. 3.29 Time Setting Page

If you select the **Manual** option, you will have to select your current **Date (Year, Month, Day)** and **Time (Hour, Minute, and Second)** from their corresponding pull-down menu under the Manual Setting box. In certain region, the daylight time saving is practiced. Then, you can check the **Enable Daylight Saving Time** box and specify the **Start Date, End Date,** and **Offset** in the fields under **Daylight Save Setting** box as shown in the greyed out area of Fig. 3.29.

After finishing changing the Time Settings, please click on **Save Configuration** button to keep all changes that you have made. A **Save Successful** message will appear with a hyperlink to **restart** the device as shown in Fig. 3.10. Please click the **restart** hyperlink to apply the changes. Then, a message indicating **System Restarting** status with a counting down number will show

up as shown in Fig. 3.11. After a successful device's restart, the web browser will be redirected to the Overview page as shown in Fig. 3.7.

3.10.6 Security

Security Settings, which are device's password and access control settings, are available in this section as shown in Fig. 3.30. The default security setting for the password is a null password, i.e. no password at all. To enable security, you can enter your preferred password in the **Change Password** box. Note that you have to enter the **Old Password** (enter nothing in case of a null password), the **New Password**, and the **Verified Password** (same as the New Password). Note that the password is case sensitive and limited to the maximum of 8 characters. After entering all required fields, click on **Save Password** button to commit the change. After the **Save Successfully** message showed up, you will be prompted with a pop-up window to enter the **User name** and the **New Password** as shown in Fig. 3.31.



- Overview
- Network
- Basic Settings
 - COM Settings
 - VCOM Settings
 - TCP Settings
 - Slave ID Map
- Advanced Settings
 - SNMP Settings
 - Modbus
- Alert
 - SMTP Settings
 - Alert Events
- System
 - Log Settings
 - System Log
 - Data Log
 - Modbus Statistic
 - Time
 - Security
 - Import/Export
 - Factory Default
- Restart

System > Security

The default password is null, you can change the password by filling in the new password to New Password and Verified Password fields, be aware that password is case sensitive.

Change Password	
Old Password	<input type="text"/>
New Password	<input type="text"/>
Verified Password	<input type="text"/>

allow one to change the access methods to protect it against intrusion. All password protect function will use same password of above 'Change Password' setting data.

Security	
Web Console	<input checked="" type="radio"/> Enable <input type="radio"/> Disable
Telnet Console	<input checked="" type="radio"/> Enable <input type="radio"/> Disable
LCM Password Protect	<input checked="" type="radio"/> No <input type="radio"/> Yes
Reset Button Protect	<input checked="" type="radio"/> No <input type="radio"/> Yes

Fig. 3.30 Security Setting Page



Fig. 3.31 Entering the User Name and the New Password

You can limit how the Modbus Gateway is accessed and controlled by changing the setting under the **Security** box in Fig. 3.30. Note that all password-protected features will use the same password that you set in the previous paragraph. You can enable or disable **Web Console** or **Telnet Console** by clicking on their corresponding radio buttons. Additionally, you can protect how the user accesses the device with **LCM Password Protect** option (only available in MB5408A / MB5416A / MB5408A2-N / MB5416A2-N Series) and **Reset Button Protect** option by checking on either **No** or **Yes** radio buttons.

After finishing changing the Security Settings, please click on **Save Configuration** button to keep all changes that you have made. A **Save Successful** message will appear with a hyperlink to **restart** the device as shown in Fig. 3.10. Please click the **restart** hyperlink to apply the changes. Then, a message indicating **System Restarting** status with a counting down number will show up as shown in Fig. 3.11. After a successful device's restart, the web browser will be redirected to the Overview page as shown in Fig. 3.7.

3.10.7 Import/Export

Once all configurations are set and the device is working properly, you may want to backup **(Export)** your configuration to a file. A backup configuration file can be used when a new firmware is uploaded and the device is reset to a factory default settings, which is to prevent accidental loading of incompatible old settings. The backup file could also be used to efficiently deploy multiple Modbus Gateways of similar settings by restoring the settings to the devices by **Importing** the corresponding file. Fig. 3.32 depicts the Import/Export page.



- Overview
- Network
- ◉ Basic Settings
 - COM Settings
 - VCOM Settings
 - TCP Settings
 - Slave ID Map
- ◉ Advanced Settings
 - SNMP Settings
 - Modbus
- ◉ Alert
 - SMTP Settings
 - Alert Events
- ◉ System
 - Log Settings
 - System Log
 - Data Log
 - Modbus Statistic
 - Time
 - Security
 - Import/Export
 - Factory Default
- Restart

System > Import/Export

Import a configuration file to the device.

Configuration File:

Export a configuration data from device and save to file.

Fig. 3.32 Import/Export Page

To import a configuration file from your computer, click on the **Browse** button. Then, a pop-up window will prompt you to choose a configuration file (with .DAT extension) from your computer to be uploaded to the device. Select your file and then click on **Open** button as shown in Fig. 3.33. Then, click on the **Import Configuration** button to start the importing process.

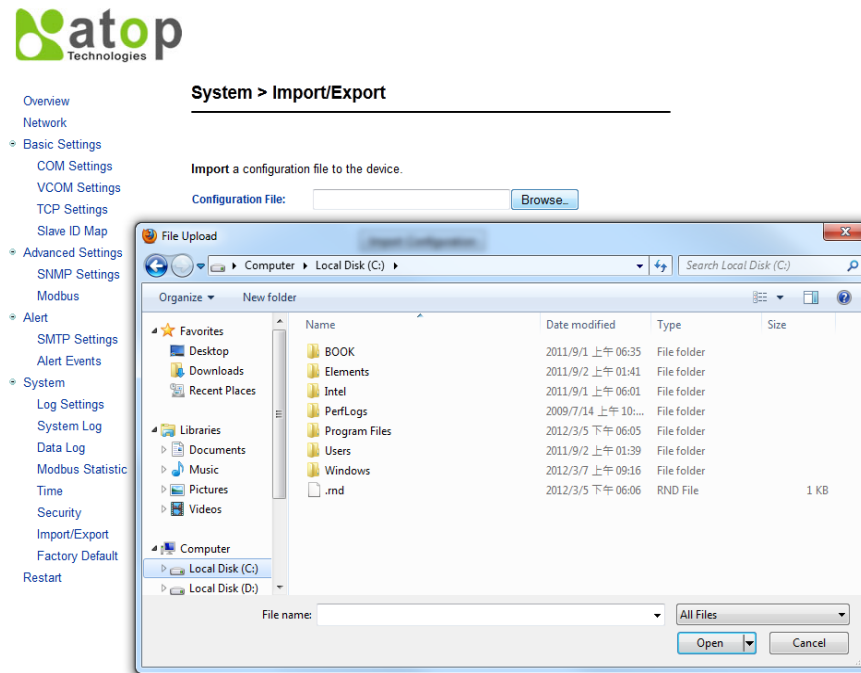

Fig. 3.33 File Chooser for Uploading a Configuration File to Modbus Gateway

After finishing importing the configuration file, the system will show a **Save Successful** message with a hyperlink to **restart** the device as shown in Fig. 3.10. Please click the **restart** hyperlink to apply the changes. Then, a message indicating **System Restarting** status with a counting down number will show up as shown in Fig. 3.11. After a successful device's restart, the web browser will be redirected to the Overview page as shown in Fig. 3.7.

To export the current configuration of your Modbus Gateway to a file for backing up, click on the **Export Configuration** button as shown in Fig. 3.34. Then, a pop-up window will prompt you to either **Open** the configuration file for viewing with a default application such as Notepad or **Save** the configuration file to your preferred destination. Note that the file name will be automatically given as the model name appended with its MAC1 address and have a “.DAT” extension. The user can change the name of the file after selecting the **Save File** option and the **Save As** window is popped up.

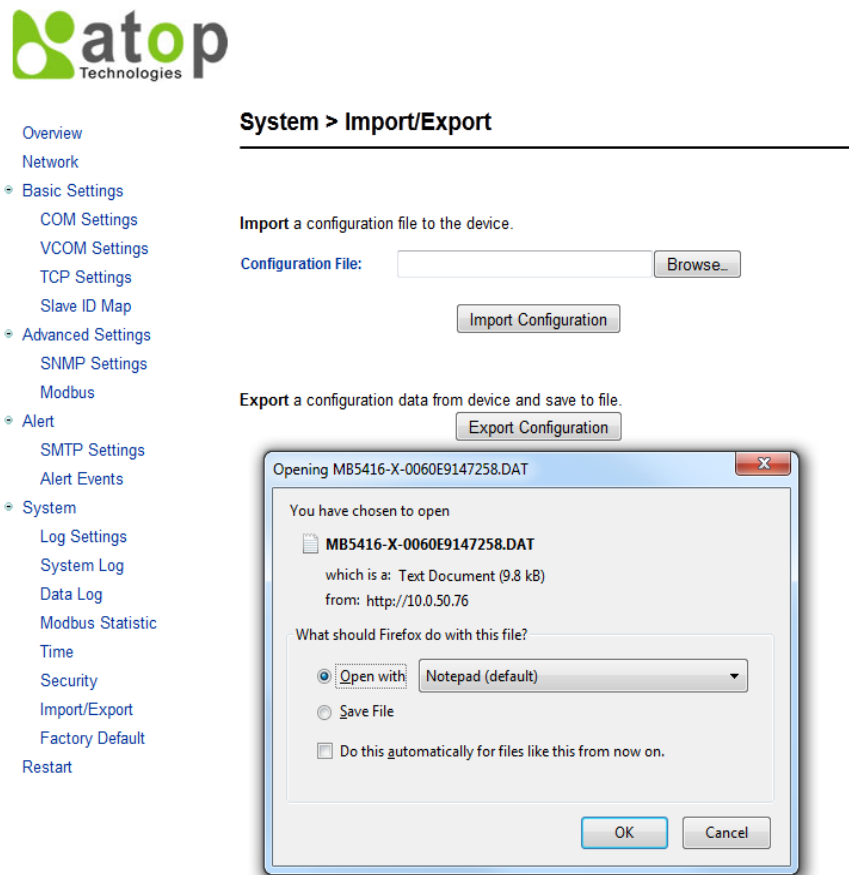

Fig. 3.34 Export Configuration File from Modbus Gateway

3.10.8 Factory Default

A simple return to **Factory Default** is available in our MB5400 Series in this section. To restore all parameters of your Modbus Gateway to the original factory default setting, click the **Set to Default and Restart** button as shown in Fig. 3.35. After a short moment, a message indicating **System Restarting** status with a counting down number will show up as shown in Fig. 3.11. After a successful device's restart, the web browser will be redirected to the Overview page as shown in Fig. 3.7.



- Overview
- Network
- Basic Settings
 - COM Settings
 - VCOM Settings
 - TCP Settings
 - Slave ID Map
- Advanced Settings
 - SNMP Settings
 - Modbus
- Alert
 - SMTP Settings
 - Alert Events
- System
 - Log Settings
 - System Log
 - Data Log
 - Modbus Statistic
 - Time
 - Security
 - Import/Export
 - Factory Default
- Restart

System > Factory Default

Restore all parameters to default.

Set to Default and Restart

Fig. 3.35 Factory Default Setting Page

3.11 Restart

For some unexpected circumstances, the Modbus Gateway system may stop responding correctly. You will have an option to restart the device by clicking on the **Restart** button as shown in Fig. 3.36. Note that the device's RUN LED will start blinking when the restart process is completed. Then, a message indicating **System Restarting** status with a counting down number will show up as shown in Fig. 3.11. After a successful device's restart, the web browser will be redirected to the Overview page as shown in Fig. 3.7.

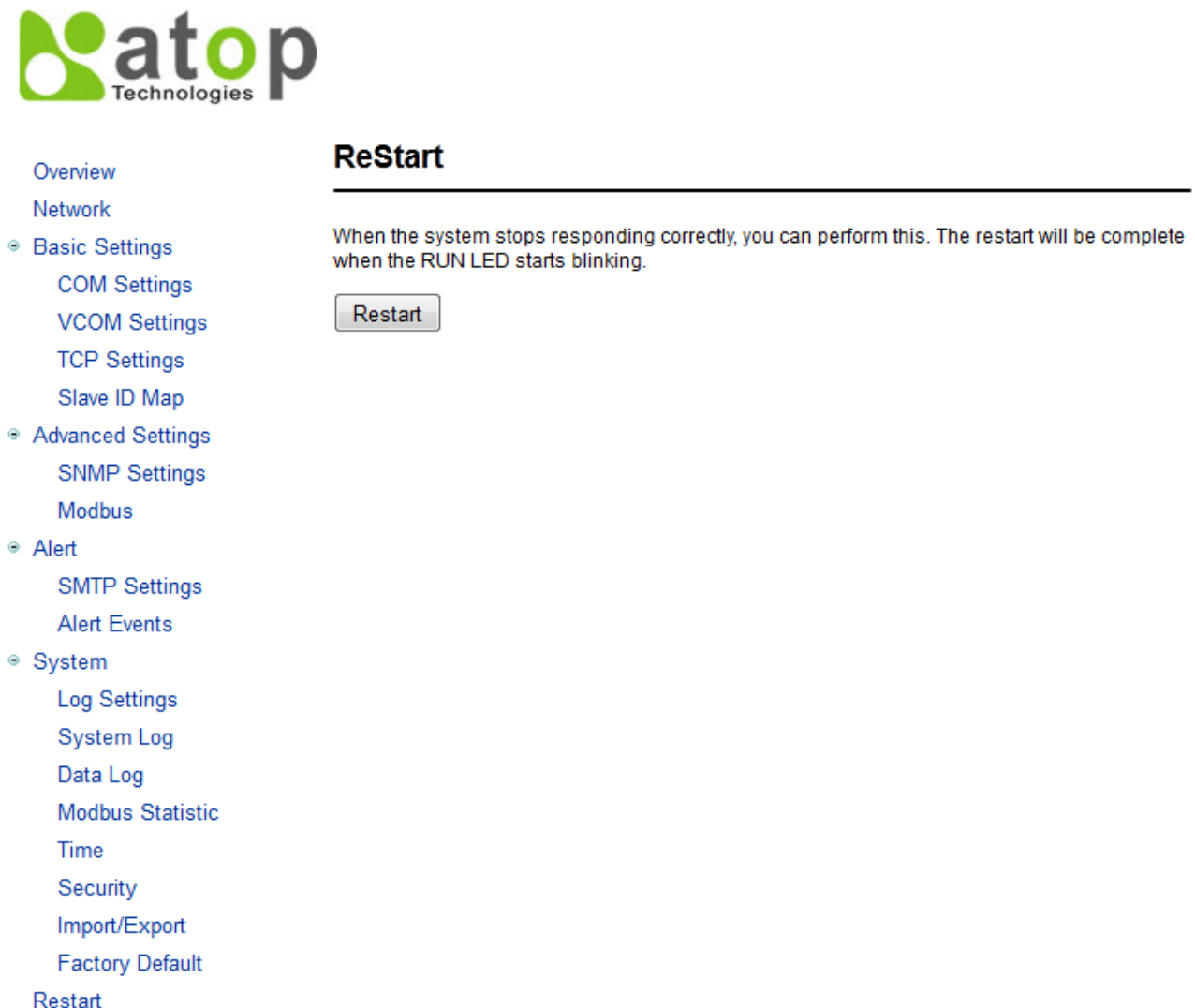

Fig. 3.36 Restart Page

4 Applications and Examples

On your device two different Slave ID mapping definitions are available in the system, which are the alias mode and the offset mode, both using Modbus ID to route the requesting command (from the Master) to the Slave node. Please see details of Slave ID setting mode in [Sec.3.7.6](#).

4.1 Using ID offset range mapping

If the Slave ID is continuous as shown in Fig. 4.1, it is recommended to use the Offset mode in your configuration setting of ID mapping as shown in Fig. 4.2.

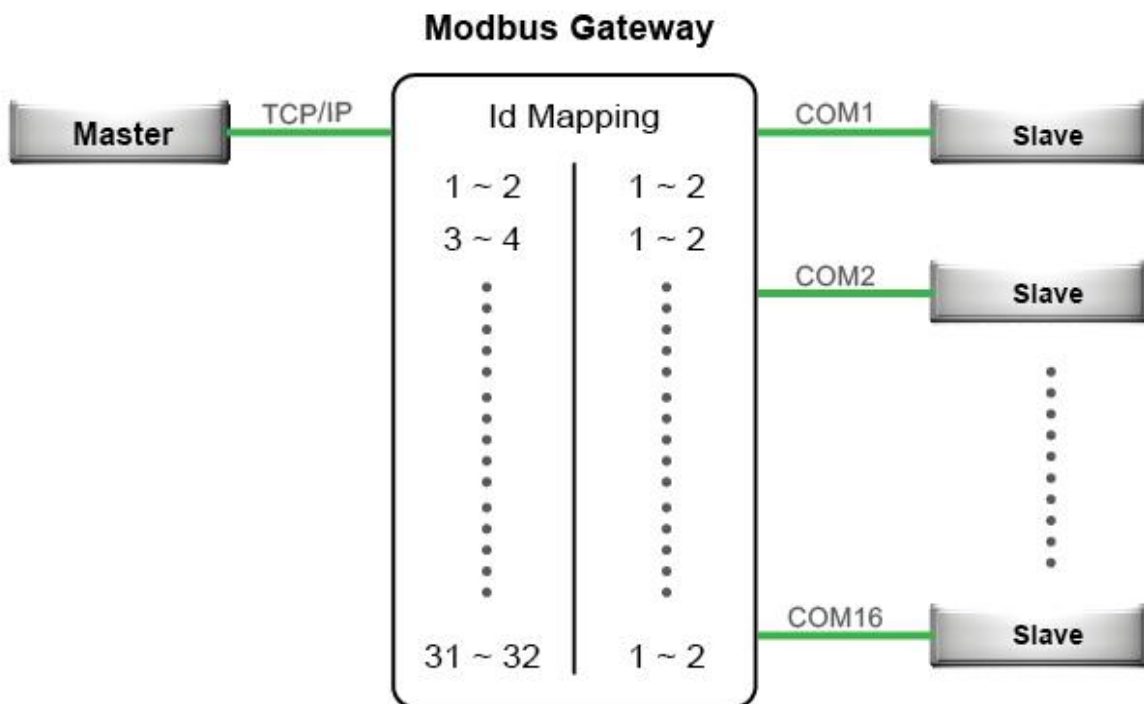

Fig. 4.1 Continuous Slave ID Mapping

<input type="checkbox"/>	Entry No.	Protocol	Source	Mode	Slave ID Range (Virtual<->Real)
<input type="checkbox"/>	01	Modbus/RTU	COM1	Offset	001 - 002 <-> 001 - 002
<input type="checkbox"/>	02	Modbus/RTU	COM2	Offset	003 - 004 <-> 001 - 002
<input type="checkbox"/>	03	Modbus/RTU	COM3	Offset	005 - 006 <-> 001 - 002
<input type="checkbox"/>	04	Modbus/RTU	COM4	Offset	007 - 008 <-> 001 - 002
<input type="checkbox"/>	05	Modbus/RTU	COM5	Offset	009 - 010 <-> 001 - 002
<input type="checkbox"/>	06	Modbus/RTU	COM6	Offset	011 - 012 <-> 001 - 002
<input type="checkbox"/>	07	Modbus/RTU	COM7	Offset	013 - 014 <-> 001 - 002
<input type="checkbox"/>	08	Modbus/RTU	COM8	Offset	015 - 016 <-> 001 - 002
<input type="checkbox"/>	09	Modbus/RTU	COM9	Offset	017 - 018 <-> 001 - 002
<input type="checkbox"/>	10	Modbus/RTU	COM10	Offset	019 - 020 <-> 001 - 002
<input type="checkbox"/>	11	Modbus/RTU	COM11	Offset	021 - 022 <-> 001 - 002
<input type="checkbox"/>	12	Modbus/RTU	COM12	Offset	023 - 024 <-> 001 - 002
<input type="checkbox"/>	13	Modbus/RTU	COM13	Offset	025 - 026 <-> 001 - 002
<input type="checkbox"/>	14	Modbus/RTU	COM14	Offset	027 - 028 <-> 001 - 002
<input type="checkbox"/>	15	Modbus/RTU	COM15	Offset	029 - 030 <-> 001 - 002
<input type="checkbox"/>	16	Modbus/RTU	COM16	Offset	031 - 032 <-> 001 - 002

Fig. 4.2 Entries of Slave ID Mapping in Offset Mode

<input type="checkbox"/>	03	Modbus/RTU	COM2	Alias	003 <-> 001
<input type="checkbox"/>	04	Modbus/RTU	COM2	Alias	004 <-> 059
<input type="checkbox"/>	05	Modbus/RTU	COM3	Alias	005 <-> 001
<input type="checkbox"/>	06	Modbus/RTU	COM3	Alias	006 <-> 059
<input type="checkbox"/>	07	Modbus/RTU	COM4	Alias	007 <-> 001
<input type="checkbox"/>	08	Modbus/RTU	COM4	Alias	008 <-> 059
<input type="checkbox"/>	09	Modbus/RTU	COM5	Alias	009 <-> 001
<input type="checkbox"/>	10	Modbus/RTU	COM5	Alias	010 <-> 059
<input type="checkbox"/>	11	Modbus/RTU	COM6	Alias	011 <-> 001
<input type="checkbox"/>	12	Modbus/RTU	COM6	Alias	012 <-> 059
<input type="checkbox"/>	13	Modbus/RTU	COM7	Alias	013 <-> 001
<input type="checkbox"/>	14	Modbus/RTU	COM7	Alias	014 <-> 059
<input type="checkbox"/>	15	Modbus/RTU	COM8	Alias	015 <-> 001
<input type="checkbox"/>	16	Modbus/RTU	COM8	Alias	016 <-> 059
<input type="checkbox"/>	17	Modbus/RTU	COM9	Alias	017 <-> 001
<input type="checkbox"/>	18	Modbus/RTU	COM9	Alias	018 <-> 059

Fig. 4.4 Entries of Slave ID Mapping in Alias Mode

5 Specifications

5.1 Software

Table 5.1 Software Tools and Utilities

Software	
Configuration	<ul style="list-style-type: none"> ■ Web-based ■ Telnet ■ LCM ■ Serial Manager®
Protocols	<ul style="list-style-type: none"> ■ Modbus TCP/ASCII/RTU ■ IPv4 ■ ARP ■ ICMP ■ TCP ■ DHCP Client ■ SNMP ■ HTTP ■ Telnet ■ RFC2217 ■ NTP ■ DNS ■ SMTP ■ Syslog
Utility	<p>“Virtual COM” Driver “Serial-IP” for Windows 98/2000/XP/2003/Vista and Linux</p>

5.2 Pin Assignments

Serial and RJ-45 Connectors

Table 5.2 Pin Assignment for RJ-45 to Serial Connectors

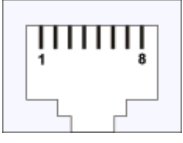
	Ethernet	RS-232	RS-422 / 4-Wire RS-485	2-Wire RS-485
Pin 1	Tx+	RTS	-	-
Pin 2	Tx-	DTR ⁽¹⁾	TX-	-
Pin 3	Rx+	TXD	TX+	-
Pin 4	-	SG	SG	SG
Pin 5	-	SG	SG	SG
Pin 6	Rx-	RXD	RX+	Data+
Pin 7	-	DSR ⁽¹⁾	RX-	Data-
Pin 8	-	CTS	-	-

(1) The isolated models does not have DTR/DSR available.

(2) SG = Signal Ground

Serial and Male DB9 connectors

Table 5.3 Pin Assignment for DB9 to RS-232/RS-422/RS-485 Connectors

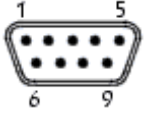
	RS-232	RS-422 / 4-Wire RS-485	2-Wire RS-485
Pin 1	DCD	-	-
Pin 2	RXD	TXD+	-
Pin 3	TXD	RXD+	Data+
Pin 4	DTR	-	-
Pin 5	SG	SG	SG
Pin 6	DSR	-	-
Pin 7	RTS	RXD-	Data-

Pin 8	CTS	TXD-	-
Pin 9	RI	-	-

5-Pin Terminal Block to RS-485/RS-422 connectors

Table 5.4 Pin Assignment for 5-Pin Terminal Block to RS-485/RS-422 Connectors

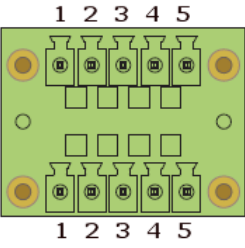
			
Pin #	RS-232	RS-422 / 4-Wire RS-485	2-Wire RS-485
Pin 1	RXD	TXD+	-
Pin 2	CTS	TXD-	-
Pin 3	TXD	RXD+	DATA+
Pin 4	RTS	RXD-	DATA-
Pin 5	SG	SG	SG

RJ-45 to Male DB9 Connector

Table 5.5 Pin Assignment for RJ-45 to Male DB9 Connector

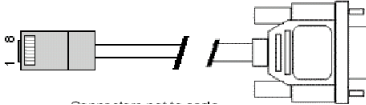
RJ45		Male DB9		
				
RTS	Pin 1	↔	Pin 7	RTS
DTR	Pin 2	↔	Pin 4	DTR
TXD	Pin 3	↔	Pin 3	TXD
SG	Pin 4	↔	Pin 5	GND
SG	Pin 5	↔		

RXD	Pin 6	↔	Pin 2	RXD
DSR	Pin 7	↔	Pin 6	DSR
CTS	Pin 8	↔	Pin 8	CTS

RS-232/RS-422 to RJ-45 Cross Over Connection

Table 5.6 Pin Assignment for RS-232/RS-422 to RJ-45 Cross Over Connection

RJ45 A				RJ45 B		
RS-422	RS-232				RS-232	RS-422
	RTS	Pin 1	↔	Pin 8	CTS	
TX-	DTR	Pin 2	↔	Pin 7	DSR	RX-
TX+	TXD	Pin 3	↔	Pin 6	RXD	RX+
	SG	Pin 4	↔	Pin 5	SG	
	SG	Pin 5	↔	Pin 4	SG	
RX+	RXD	Pin 6	↔	Pin 3	TXD	TX+
RX-	DSR	Pin 7	↔	Pin 2	DTR	TX-
	CTS	Pin 8	↔	Pin 1	RTS	

LED Indicators

Table 5.7 LED indicators for MB5408A/MB5416A/MB5408A2-N/MB5416A2-N

Name	Color	Status	Message
Power	Green	On	System is powered on
		Off	System is not powered on
Ready	Green	Blinking	AP firmware is running normally
		On/Off	System is not running normally
COM	Green	Blinking	Data is transmitting on COM port
		Off	No data is transmitting
LAN	Orange	On	Ethernet is connected at 100Mbps

		Off	Ethernet is connected at 10Mbps or Disconnected
	Green	Blinking	Data is transmitting on this port
		Off	Ethernet is Disconnected

Table 5.8 LED indicators for MB5404D and MB5404D-Sis-X

Name	Color	Status	Message
Power	Green	On	System is powered on
		Off	System is not powered on
RUN	Green	Blinking	AP firmware is running normally
		Off	System is not ready or halt
COM	Green	Blinking	Data is transmitting on COM port
		Off	No data is transmitting
LAN	Orange	Blinking	Data is transmitting on Ethernet at 10Mbps
	Green	Blinking	Data is transmitting on Ethernet at 100Mbps
		Off	Ethernet is Disconnected

6 Appendix: Configuration using Telnet Interface

The MB5400 Modbus Gateway device has a built-in Telnet server program such that users can also configure the device using Telnet console software. To start the device configuration using Telnet console, please go to Windows Command software (Start→Run) and use “telnet” command to access the device. In the “Run” window, enter “*telnet device_IP_address*” (For example, “telnet 10.0.50.100” if the device is connected to LAN1 port) in the **Open:** field as shown in Fig. 6.1. The system will prompt for Username and Password. After the valid username and password are entered, the main menu shall appear as shown in Fig. 6.6. The figure shows all the configurations that can be used on the device. Note that If Telnet is not yet configured in your operating system such as Windows Vista or later, please follow the steps mentioned below to configure it.

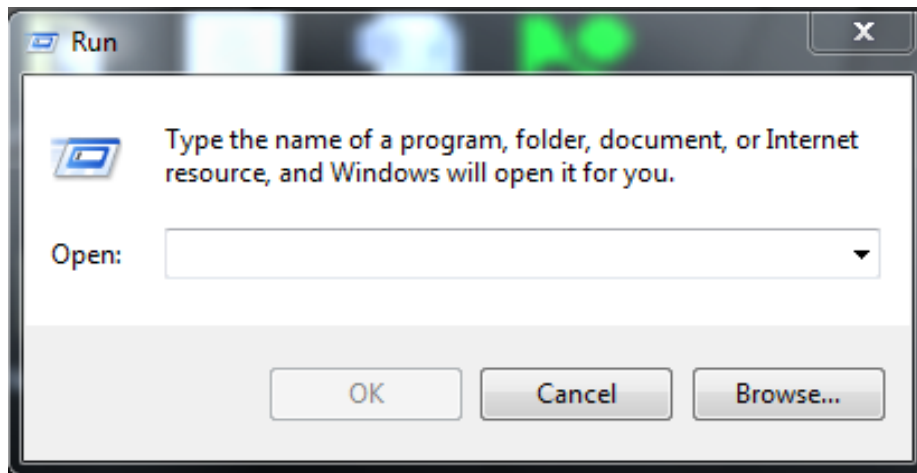

Fig. 6.1 Run Window for Entering telnet command

Note:

- The steps described below are for **Windows®** platforms.

For alternative Telnet interface configuring in Windows® XP, please go to **Windows® Hyper Terminal** and follow the steps described below.

- On your Desktop go to **“Start → All Programs → Accessories → Communications → HyperTerminal”** as shown in Fig. 6.2.



Fig. 6.2 HyperTerminal Menu on Windows® XP

- Fill the Name entry with a name of your choice such as “**ATOP_device**”, and select your favorite icon as shown in Fig. 6.3. After click the **OK** button, the “**Connect to**” window will pop-up as shown in Fig. 6.4.



Fig. 6.3 Connection Description Pop-up Window for HyperTerminal

- Select “**TCP/IP Winsock**” on “**Connect using**” pull-down menu at the bottom of the “**Connect to**” window as shown in Fig. 6.4, then type the Modbus Gateway IP’s address in the **Host address** field such as “10.0.50.100”. Then, click the **OK** button. Note that leave the default port number for telnet as **Port number: 23**.

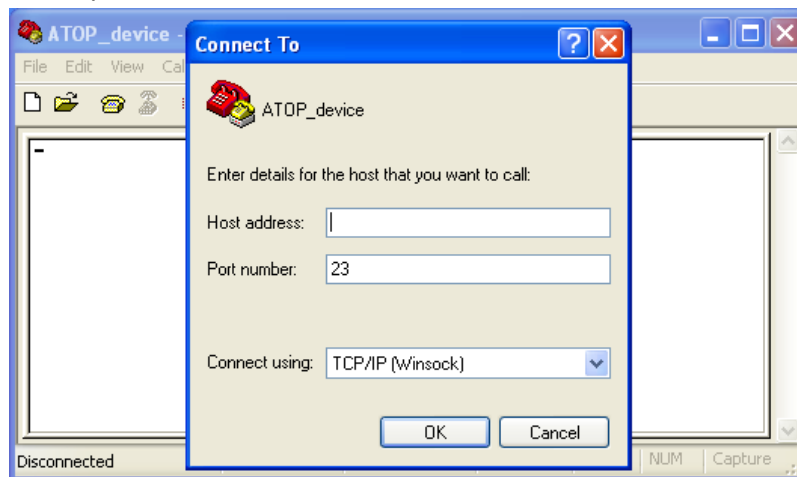

Fig. 6.4 Connect To Pop-up Windows

- Here “**ATOP_device - Hyperterminal**” window will appear as shown in Fig. 6.5, and the Modbus Gateway will prompt you for logging in with the Username and the Password.

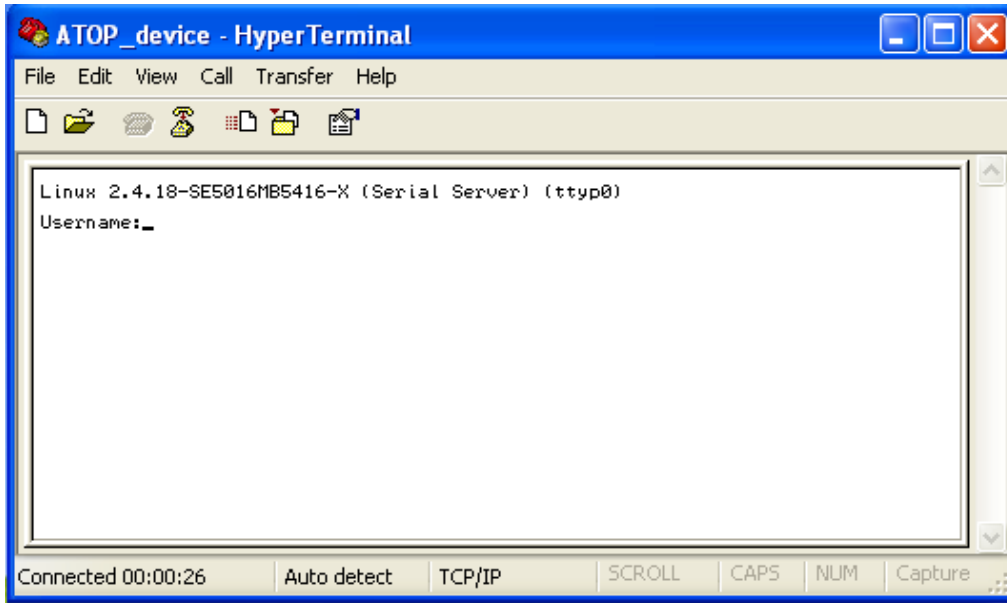

Fig. 6.5 Username Prompt inside Telnet HyperTerminal

- Once the correct username and password are entered, you will see the configuration menu of the device on the display as shown in the prompt of Fig. 6.6.

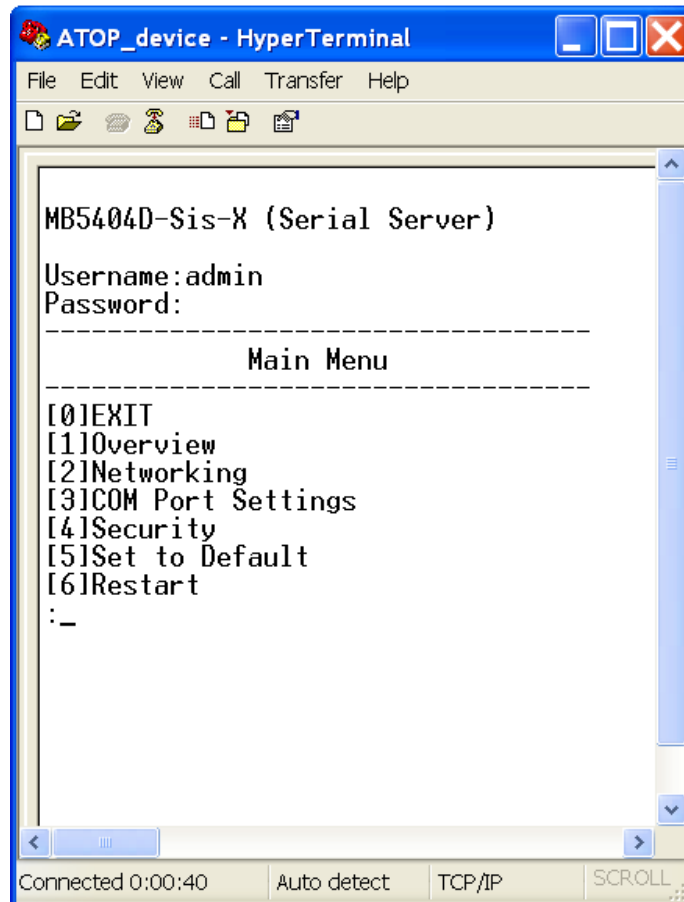

Fig. 6.6 Telnet Configuration Menu

The previous steps are for Windows® XP, in order to enable telnet in Windows® 7 follows the steps below.

1. Go to **Start** and on the “**Run**” box type **cmd** as shown in Fig. 6.7.

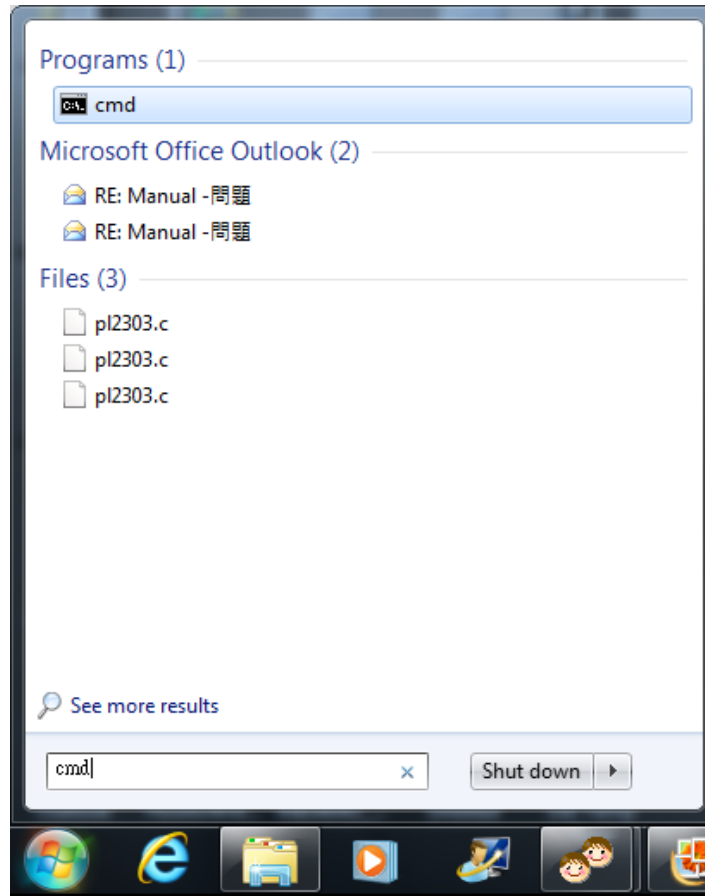

Fig. 6.7 Run Box on the Start Window

2. A pop-up window will appear as shown in Fig. 6.8, type “**pkmgr /iu:"TelnetClient"**” and press Enter. Your Telnet client will be configured after a short moment. If you wish to verify if it is working correctly, please follow the step after next step. Alternatively, you can turn on Telnet Client feature of Windows® 7 by following the next step. Note that these similar steps are applicable for turning on Telnet Client in Windows® 8 and 8.1.

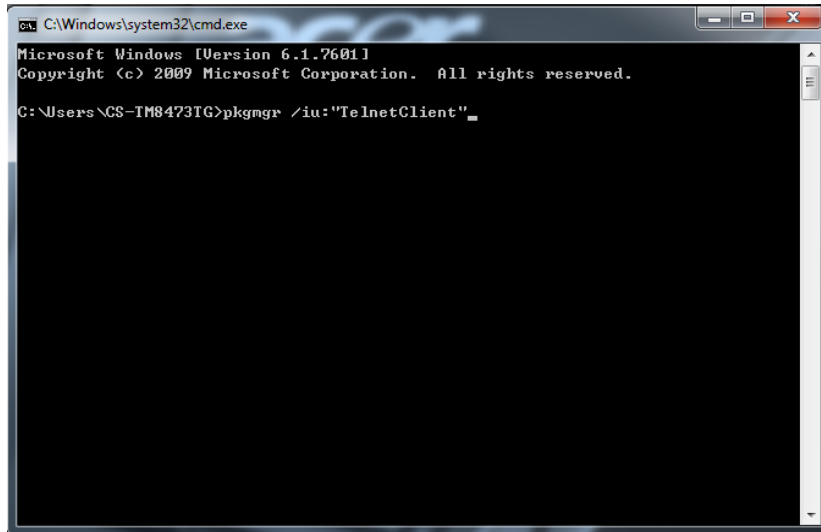

Fig. 6.8 Command Window with Telnet Configuration Command

3. Go to **Control Panel** under **Programs and Features**. Select **Turn Windows features on or off** and check the **Telnet Client** box as shown in Fig. Fig. 6.9.

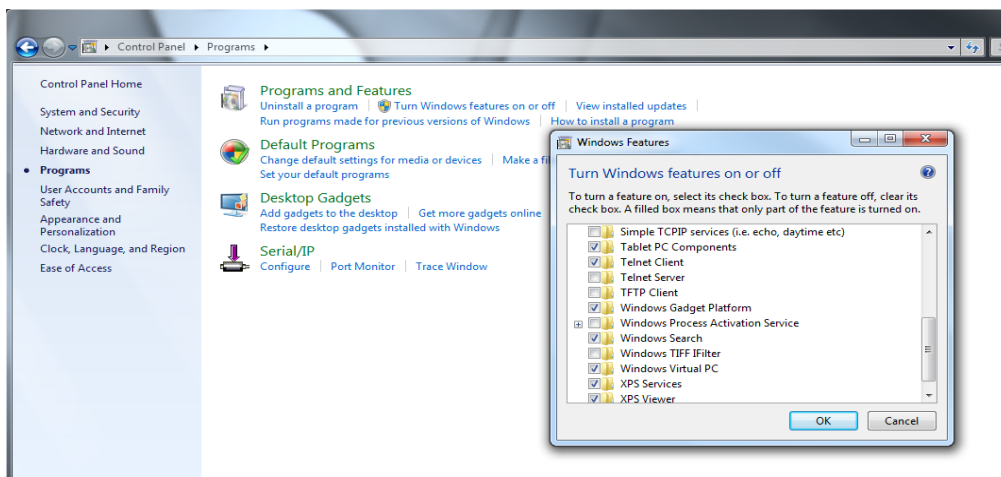

Fig. 6.9 Windows Features Pop-up Menu

Note: Default “TCP port numbers” (in this manual, TCP port number, TCP local port number and TCP logical number are synonymous) are 4660 – 4667 for the MB5408A and MB5408A2-N models, and 4660 – 4675 for the MB5416A and MB5416A2-N models, each corresponding to COM1 – COM8 and COM1 – COM16, respectively.

After these steps are completed, telnet can be accessed by typing the telnet command with the Modbus Gateway's IP address using the “Run” command window on the **Start** menu as shown in Fig. 6.10 and entering the “**telnet 10.0.50.100**” command in the **Open:** field of Run pop-up window of Fig. 6.11.

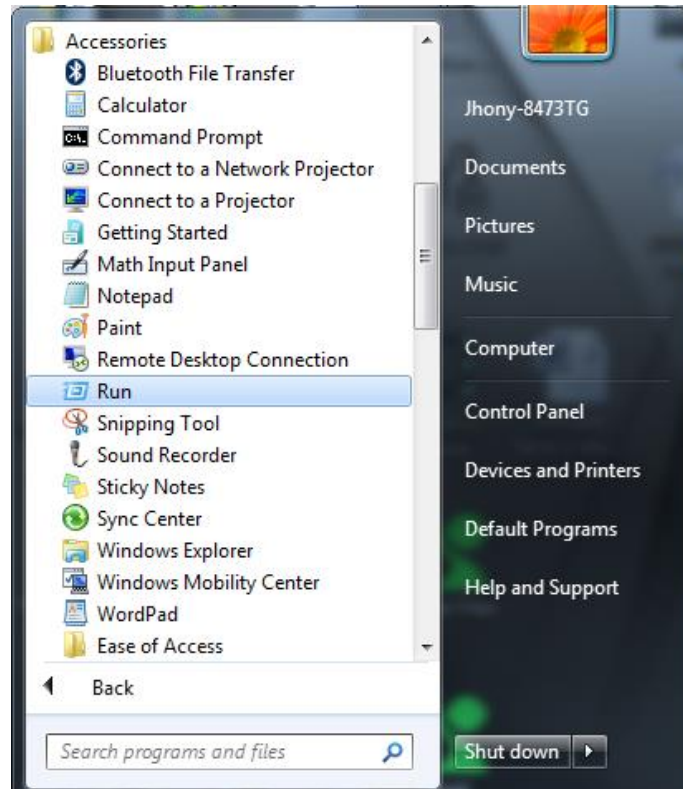

Fig. 6.10 Run command in Windows®7 Start Menu

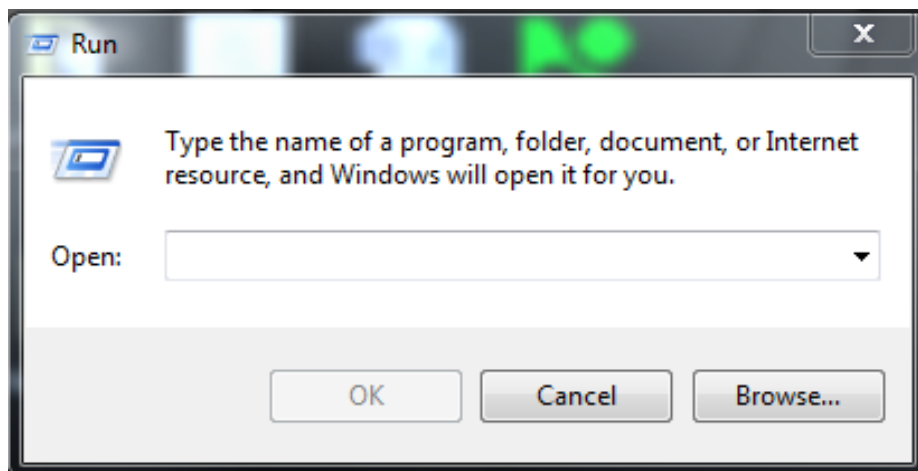
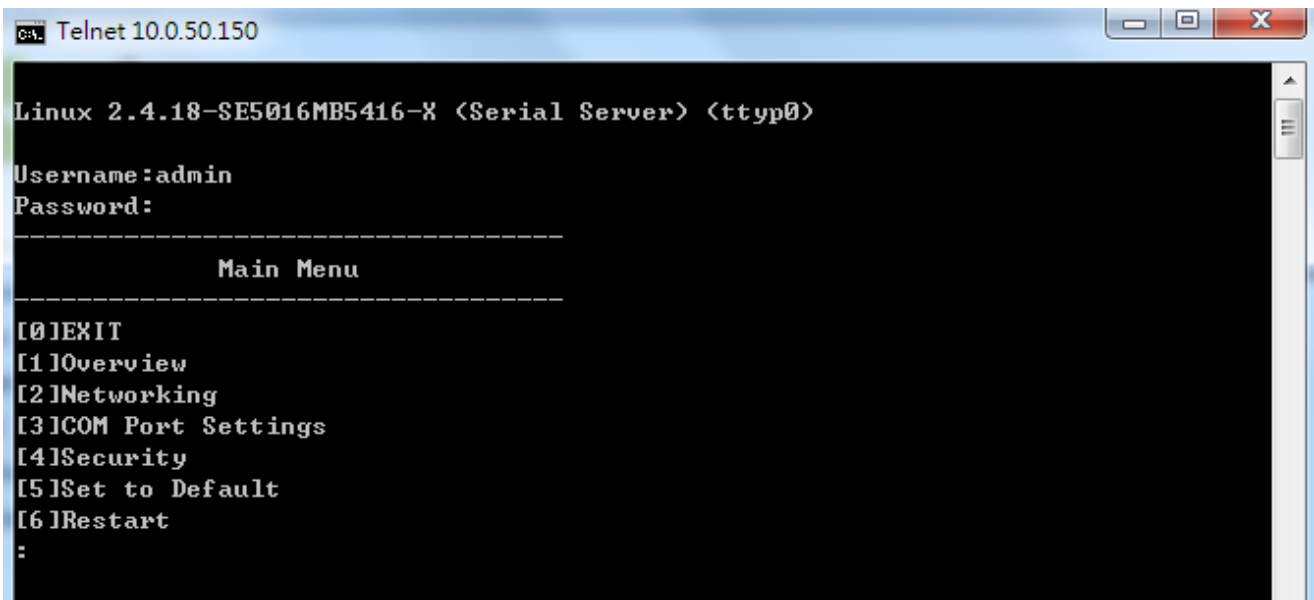

Fig. 6.11 Run pop-up window

The main menu of Modbus Gateway is a command driven interface. An example of the main menu will be similar to Fig. 6.12.



```

Telnet 10.0.50.150
Linux 2.4.18-SE5016MB5416-X <Serial Server> <ttyp0>
Username: admin
Password:
-----
                Main Menu
-----
[0]EXIT
[1]Overview
[2]Networking
[3]COM Port Settings
[4]Security
[5]Set to Default
[6]Restart
:

```

Fig. 6.12 Main Menu

Most options are the same as the ones in the web browsing mode as described in [Sec.3](#). The only difference is that they have to be accessed by entering the number corresponded to that option. We will use the notion of number in the square bracket, i.e. [0], [1], [2], ..., as the number entered.

For accessing each function, please follow the steps described below.

Note:

- You can always press "0" key to return to the upper layer menu.
- If the device does not receive any command within 3 minutes, Telnet connection will be automatically terminated.

- On the **Main Screen** → **[1] Overview** as shown in Fig. 6.13, (a more detailed description of this section is given in [Sec.3.5.](#))

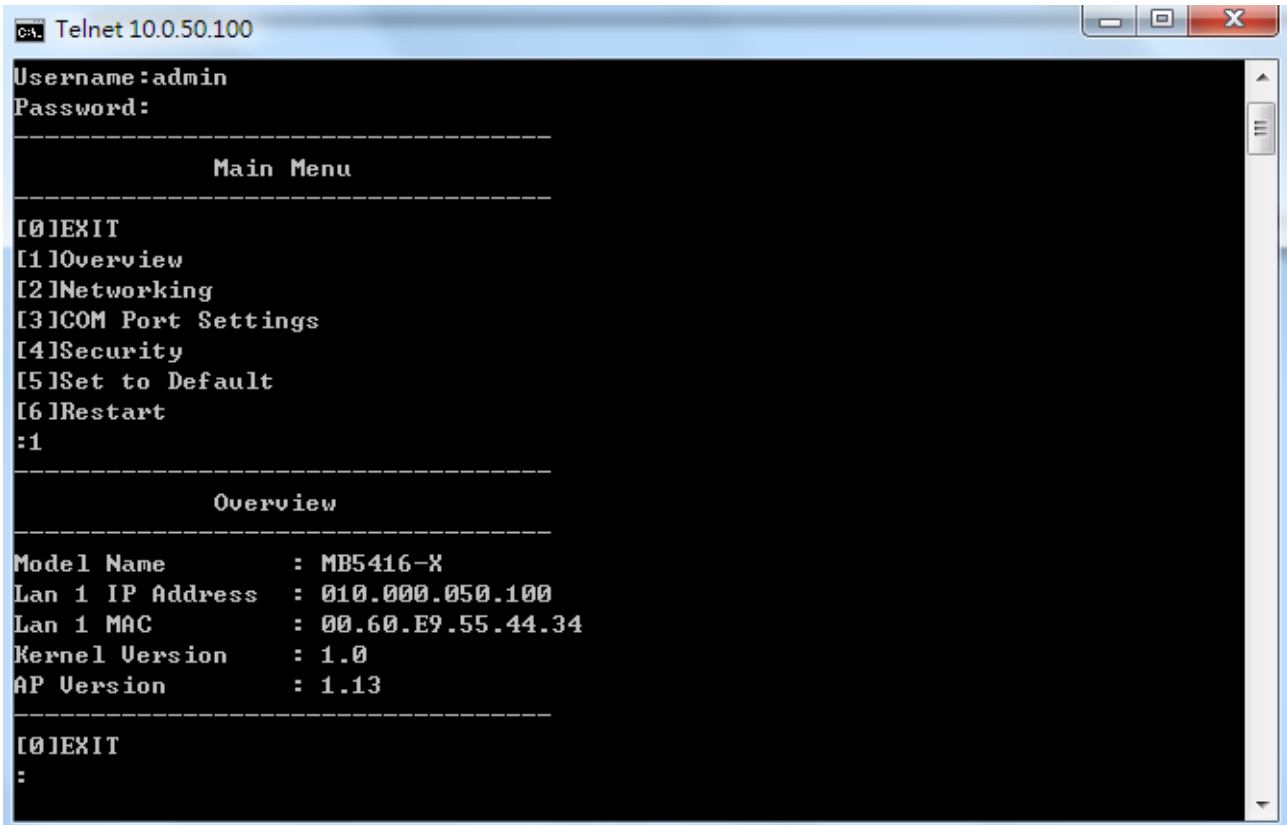

```
Ca. Telnet 10.0.50.100
Username: admin
Password:
-----
                Main Menu
-----
[0]EXIT
[1]Overview
[2]Networking
[3]COM Port Settings
[4]Security
[5]Set to Default
[6]Restart
:1
-----
                Overview
-----
Model Name       : MB5416-X
Lan 1 IP Address : 010.000.050.100
Lan 1 MAC        : 00.60.E9.55.44.34
Kernel Version   : 1.0
AP Version       : 1.13
-----
[0]EXIT
:
```

Fig. 6.13 Overview Section

- **Main Screen** → **[2] Networking** as shown in Fig. 6.14, (a more detailed description of this section is given in [Sec.3.6.](#))

A screenshot of a Telnet window titled 'Telnet 10.0.50.100'. The window shows a text-based menu interface. At the top, it displays 'AP Version : 1.13'. Below this is a dashed line separator, followed by '[0]EXIT' and ':0'. Another dashed line separator leads to the 'Main Menu' section, which lists options: '[0]EXIT', '[1]Overview', '[2]Networking', '[3]COM Port Settings', '[4]Security', '[5]Set to Default', and '[6]Restart', followed by ':2'. A third dashed line separator leads to the 'Networking' section, which lists: '[0]EXIT', '[1]LAN 1 Settings', '[2]DNS Settings', and '[3]SNMP Settings', followed by ':'. The window has a standard Windows-style title bar with minimize, maximize, and close buttons.

Fig. 6.14 Networking Menu

- **Main Screen → [2] Networking → [1]LAN 1 Settings** as shown in Fig. 6.15, (a more detailed description of this section is given in [Sec.3.6.](#))

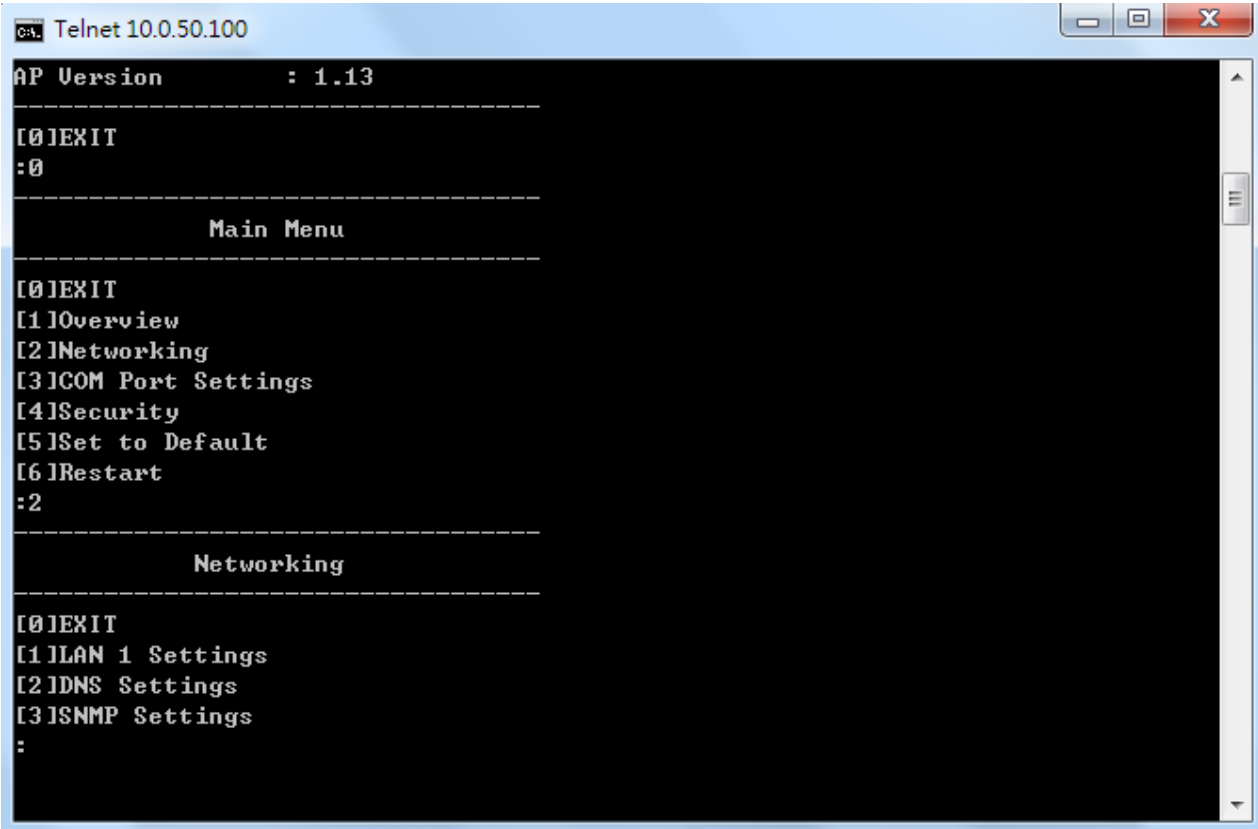
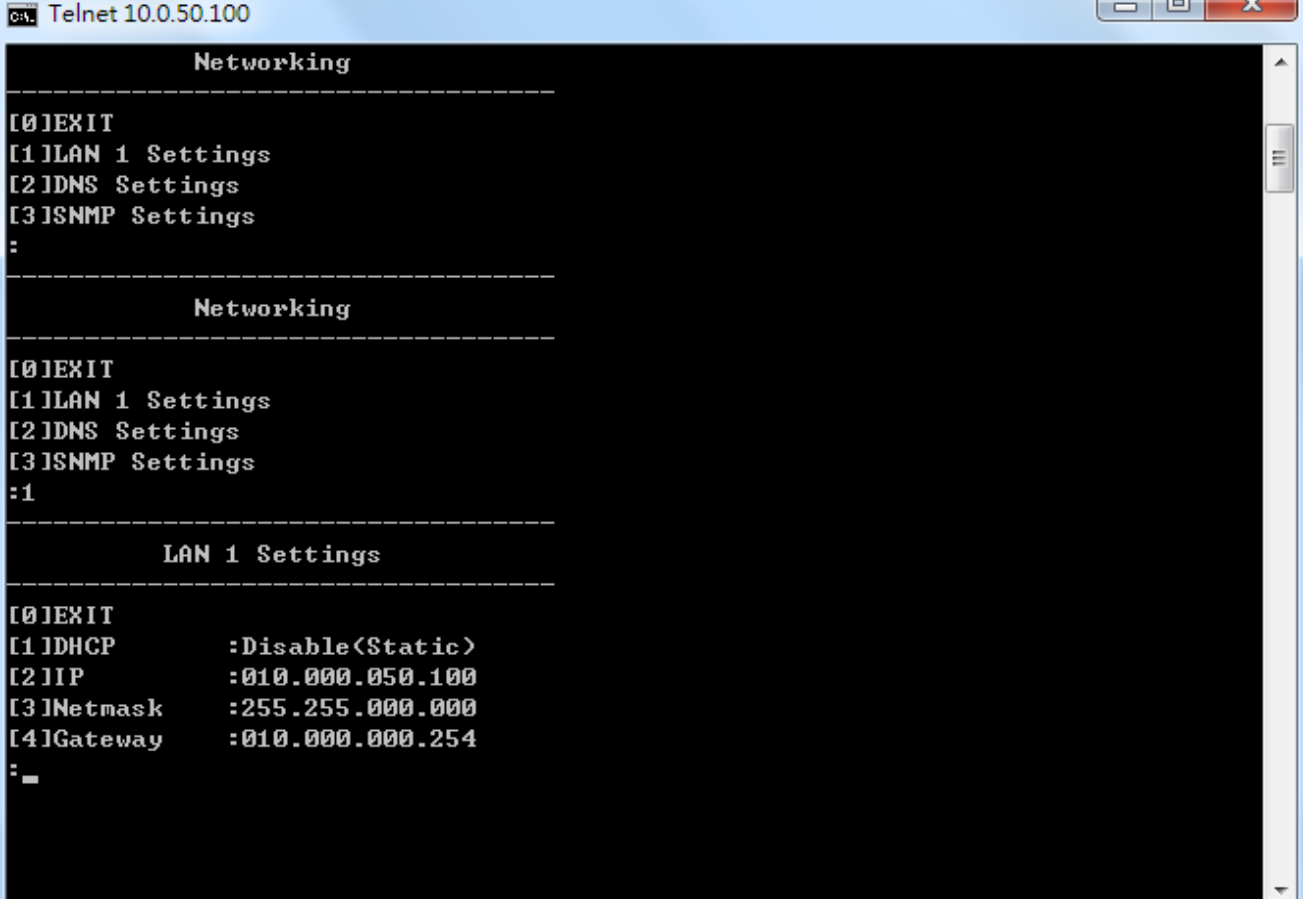

```
C:\> Telnet 10.0.50.100

Networking
-----
[0]EXIT
[1]LAN 1 Settings
[2]DNS Settings
[3]SNMP Settings
:

Networking
-----
[0]EXIT
[1]LAN 1 Settings
[2]DNS Settings
[3]SNMP Settings
:1

LAN 1 Settings
-----
[0]EXIT
[1]DHCP      :Disable(Static)
[2]IP       :010.000.050.100
[3]Netmask  :255.255.000.000
[4]Gateway  :010.000.000.254
:
_
```

Fig. 6.15 LAN 1 Settings Menu

- **Main Screen** → **[2] Networking** → **[2] DNS Settings** as shown in Fig. 6.16, (a more detailed description of this section is given in [Sec.3.6.](#))

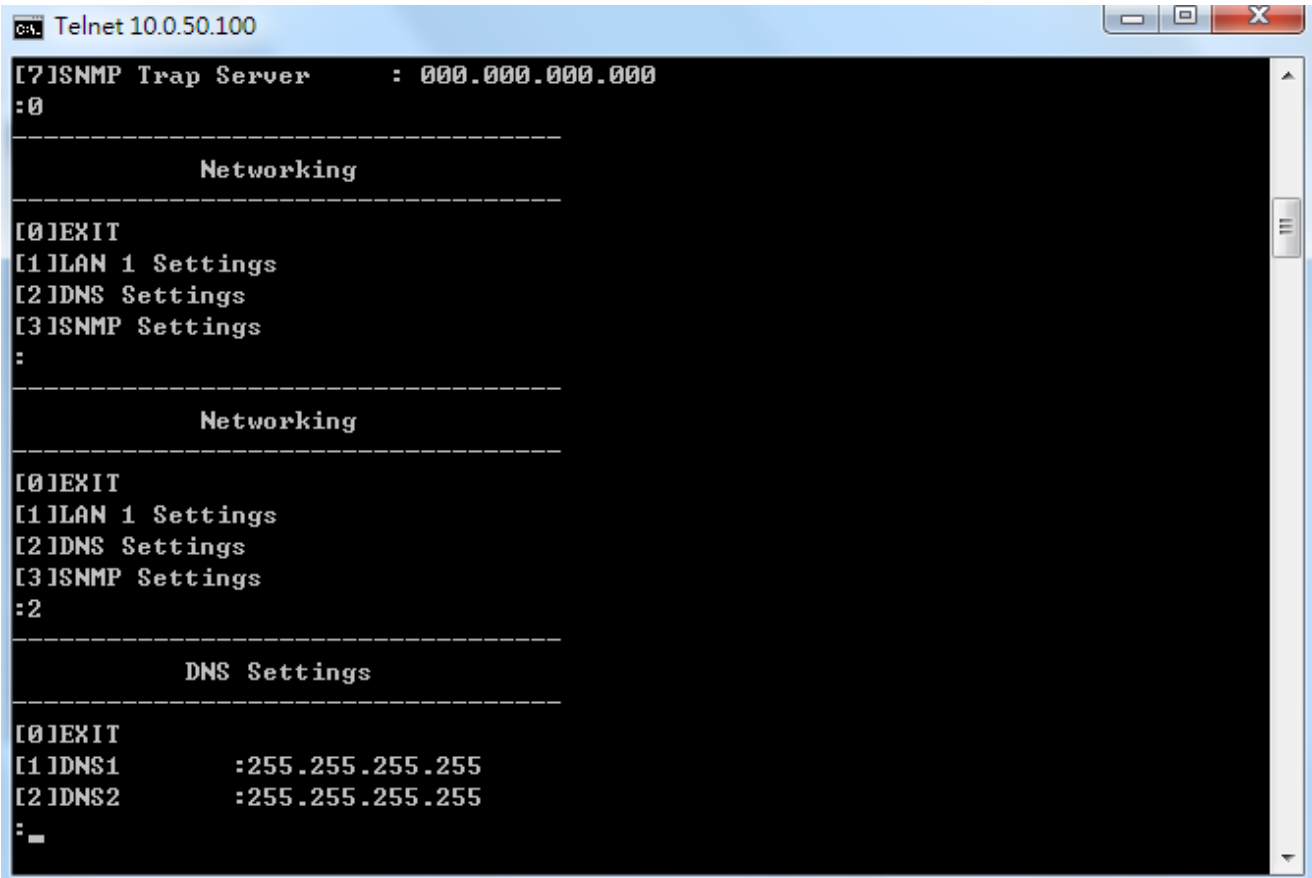

```

Telnet 10.0.50.100
[7] ISNMP Trap Server      : 000.000.000.000
:0
-----
Networking
-----
[0] EXIT
[1] LAN 1 Settings
[2] DNS Settings
[3] ISNMP Settings
:
-----
Networking
-----
[0] EXIT
[1] LAN 1 Settings
[2] DNS Settings
[3] ISNMP Settings
:2
-----
DNS Settings
-----
[0] EXIT
[1] DNS1      :255.255.255.255
[2] DNS2      :255.255.255.255
:

```

Fig. 6.16 DNS Settings Menu

- **Main Screen** → **[2] Networking** → **[3] SNMP Settings** as shown in Fig. 6.17, (a more detailed description of this section is given on [Sec.3.8.1](#))

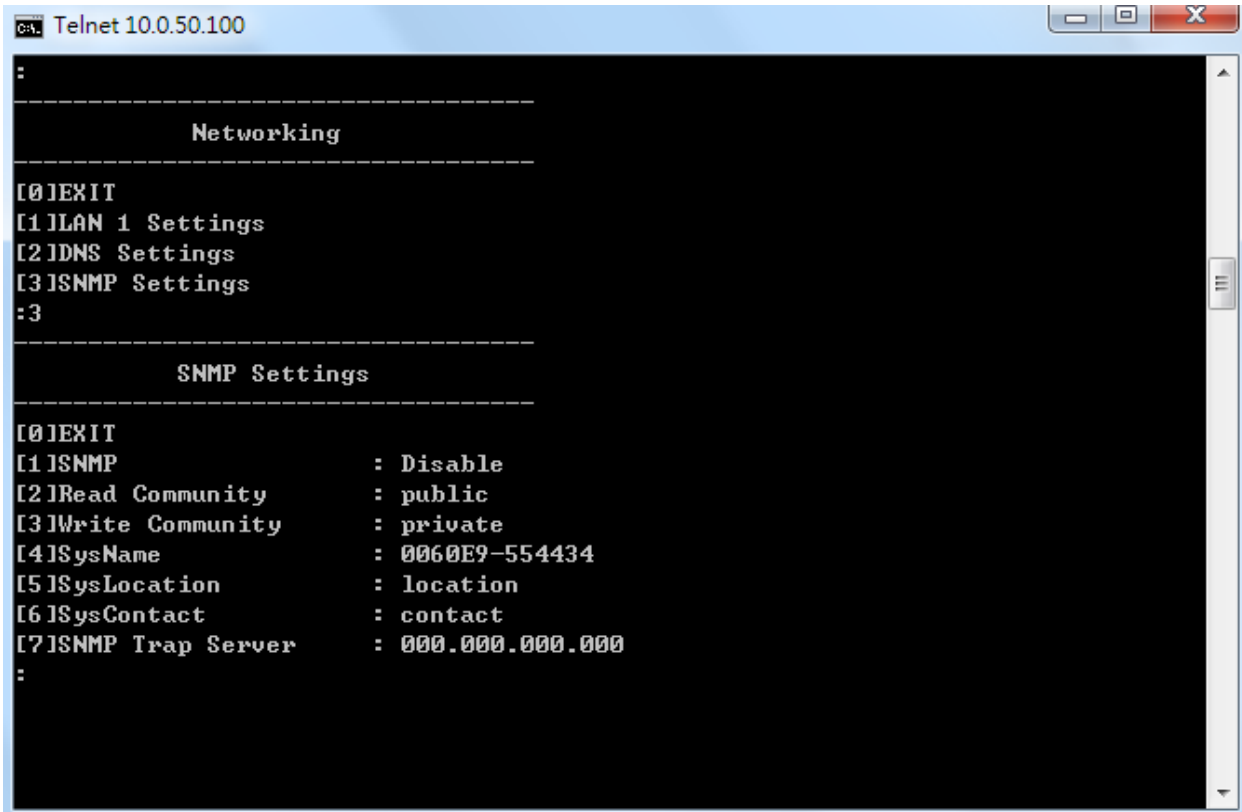
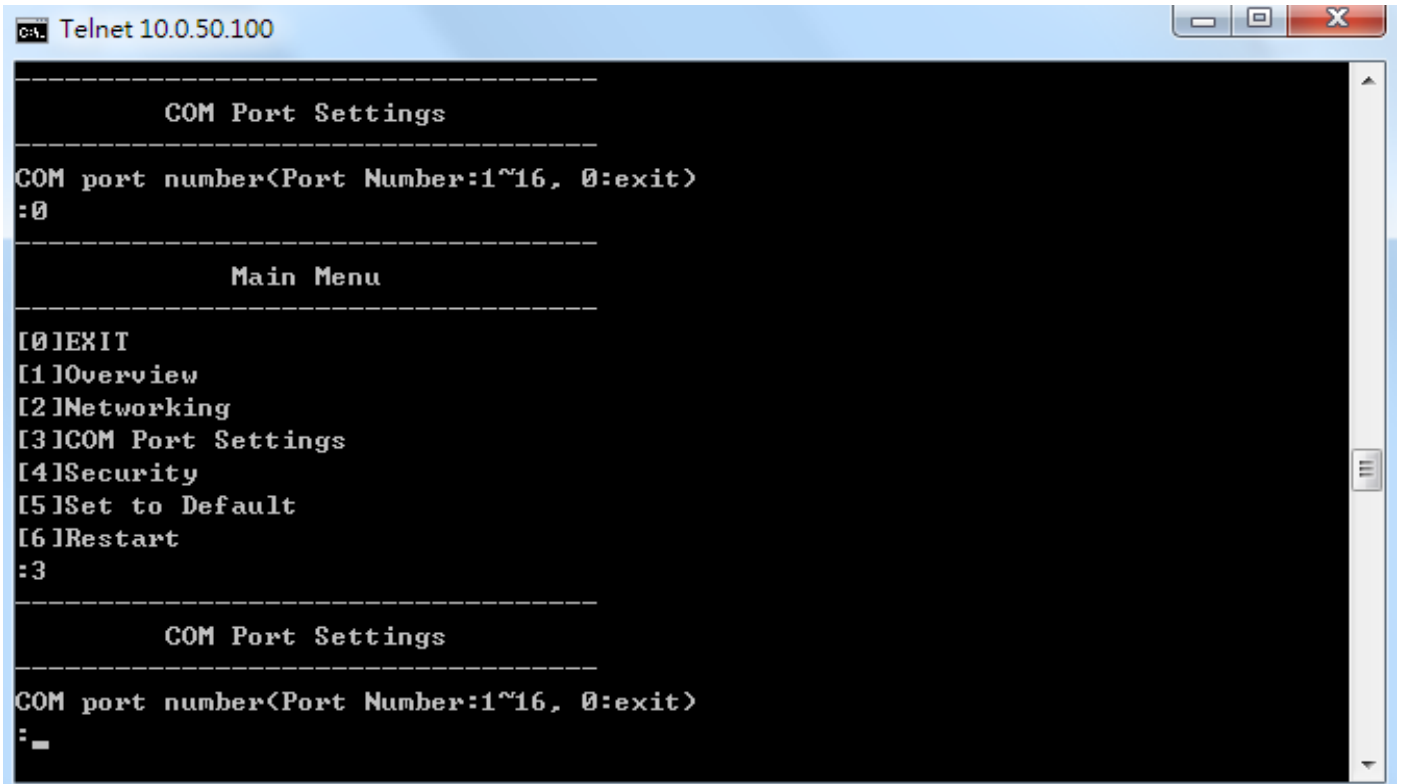

Fig. 6.17 SNMP Settings Menu

COM Port Configuration: telnet

- **Main Screen** → **[3] COM Port Setting** as shown in Fig. 6.18, (a more detailed description of this section is given in [Sec.3.7.1.](#))



```
C:\> Telnet 10.0.50.100

-----
          COM Port Settings
-----
COM port number<Port Number:1~16, 0:exit>
:0

-----
          Main Menu
-----
[0]EXIT
[1]Overview
[2]Networking
[3]COM Port Settings
[4]Security
[5]Set to Default
[6]Restart
:3

-----
          COM Port Settings
-----
COM port number<Port Number:1~16, 0:exit>
:_
```

Fig. 6.18 COM Port Settings Menu

- **Main Screen → [3] COM Port Setting → COM port number: [select either 1~16]**
(click Enter)→ [1] Com Settings as shown in Fig. 6.19, (a more detailed description of this section is given in [Sec.3.7.1.](#))

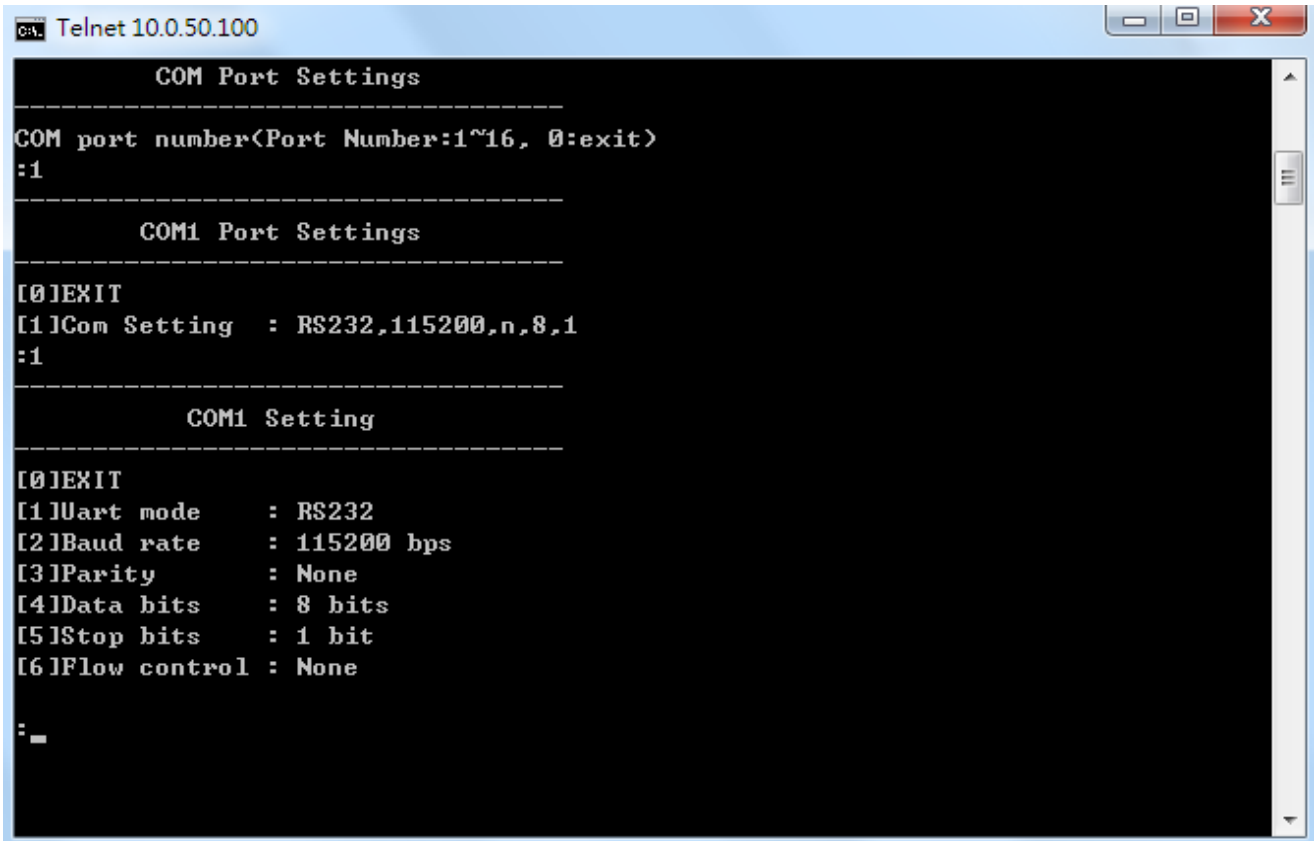

```

Telnet 10.0.50.100
-----
COM Port Settings
-----
COM port number<Port Number:1~16, 0:exit>
:1
-----
COM1 Port Settings
-----
[0]EXIT
[1]Com Setting : RS232,115200,n,8,1
:1
-----
COM1 Setting
-----
[0]EXIT
[1]Uart mode : RS232
[2]Baud rate : 115200 bps
[3]Parity : None
[4]Data bits : 8 bits
[5]Stop bits : 1 bit
[6]Flow control : None
:

```

Fig. 6.19 COM1 Setting Menu

- **Main Screen** → **[4] Security** as shown in Fig. 6.20, (a more detailed description of this section is given in [Sec.3.10.6.](#))

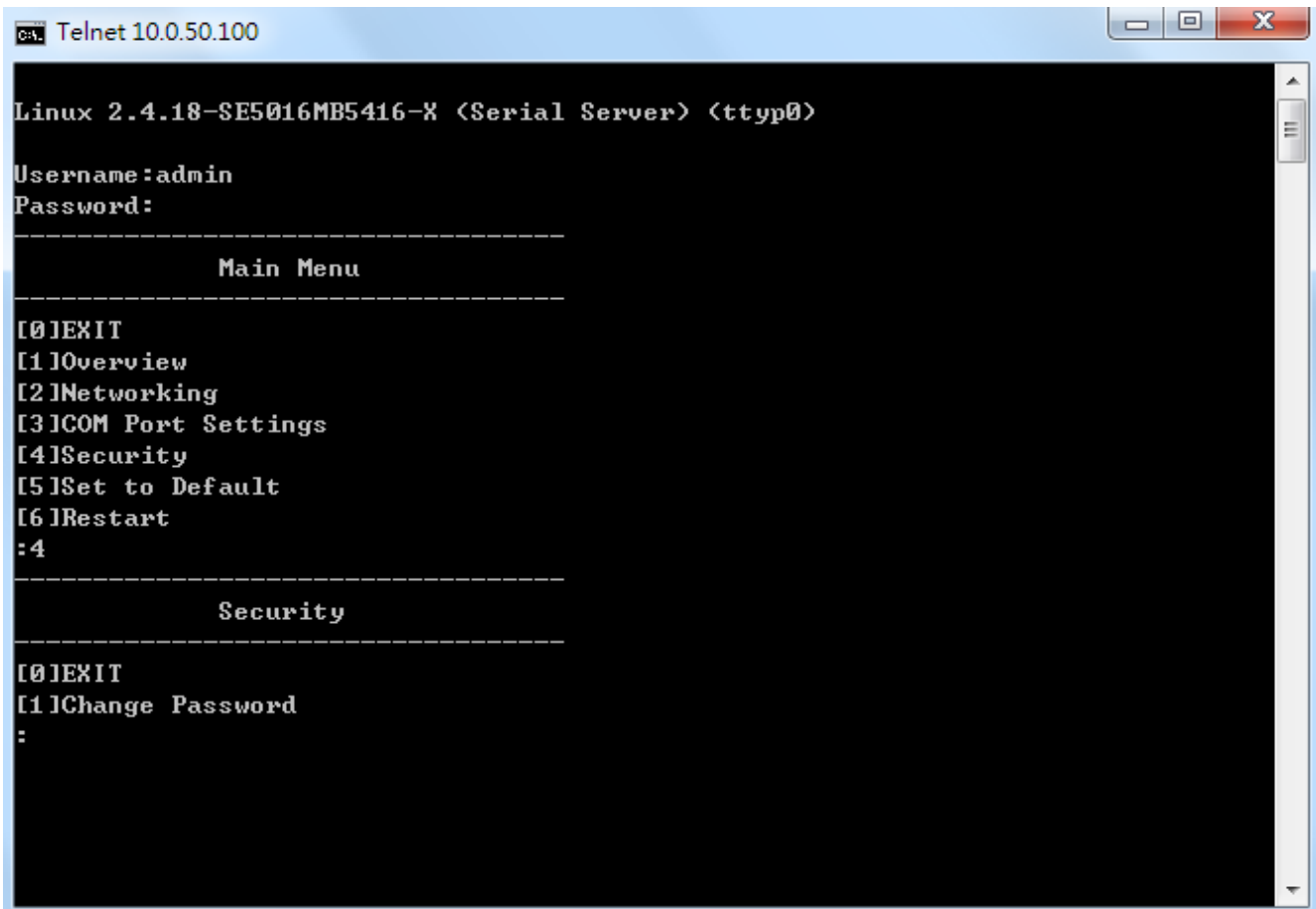
A screenshot of a Telnet window titled "Telnet 10.0.50.100". The window shows a terminal interface for a Linux 2.4.18-SE5016MB5416-X (Serial Server) on ttyp0. The user has logged in as "admin". The terminal displays a "Main Menu" with options: [0]EXIT, [1]Overview, [2]Networking, [3]COM Port Settings, [4]Security, [5]Set to Default, and [6]Restart. The user has selected option [4]Security, and the terminal now displays a "Security" menu with options: [0]EXIT and [1]Change Password. The cursor is positioned at the end of the "Security" menu.

```
C:\> Telnet 10.0.50.100

Linux 2.4.18-SE5016MB5416-X <Serial Server> <ttyp0>

Username: admin
Password:

-----
                Main Menu
-----

[0]EXIT
[1]Overview
[2]Networking
[3]COM Port Settings
[4]Security
[5]Set to Default
[6]Restart
:4

-----
                Security
-----

[0]EXIT
[1]Change Password
:
```

Fig. 6.20 Security Menu

- **Main Screen → [4] Security → [1] Change Password** as shown in Fig. 6.21, (a more detailed description of this section is given in [Sec.3.10.6.](#))

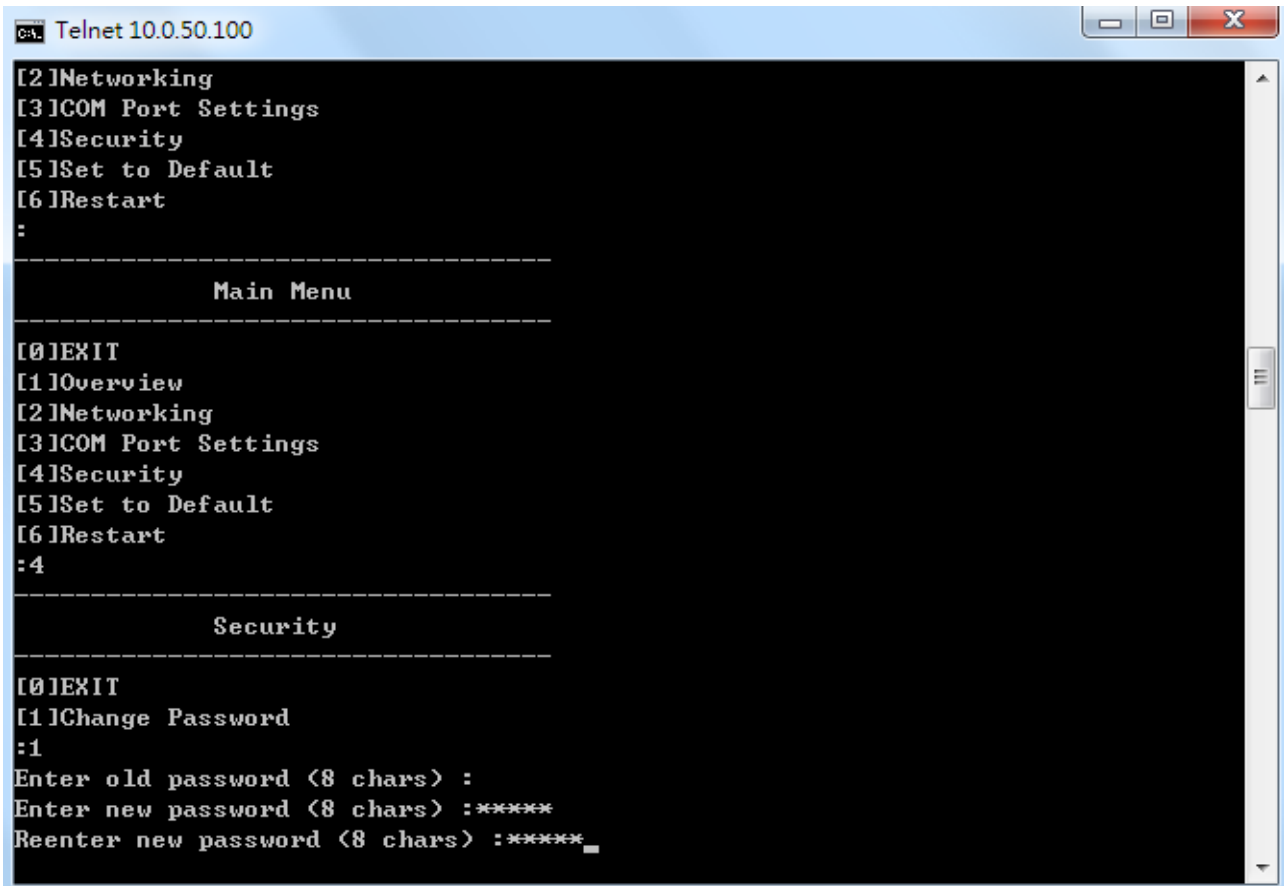

```
C:\> Telnet 10.0.50.100

[2]Networking
[3]COM Port Settings
[4]Security
[5]Set to Default
[6]Restart
:
-----
                Main Menu
-----
[0]EXIT
[1]Overview
[2]Networking
[3]COM Port Settings
[4]Security
[5]Set to Default
[6]Restart
:4
-----
                Security
-----
[0]EXIT
[1]Change Password
:1
Enter old password (8 chars) :
Enter new password (8 chars) :*****
Reenter new password (8 chars) :*****_
```

Fig. 6.21 Security Menu Selection with Changing Password

Reset to Factory Defaults

Main Screen → **[5] Set to Default** as shown in Fig. 6.22, (a more detailed description of this section is given in [Sec.3.10.8.](#))

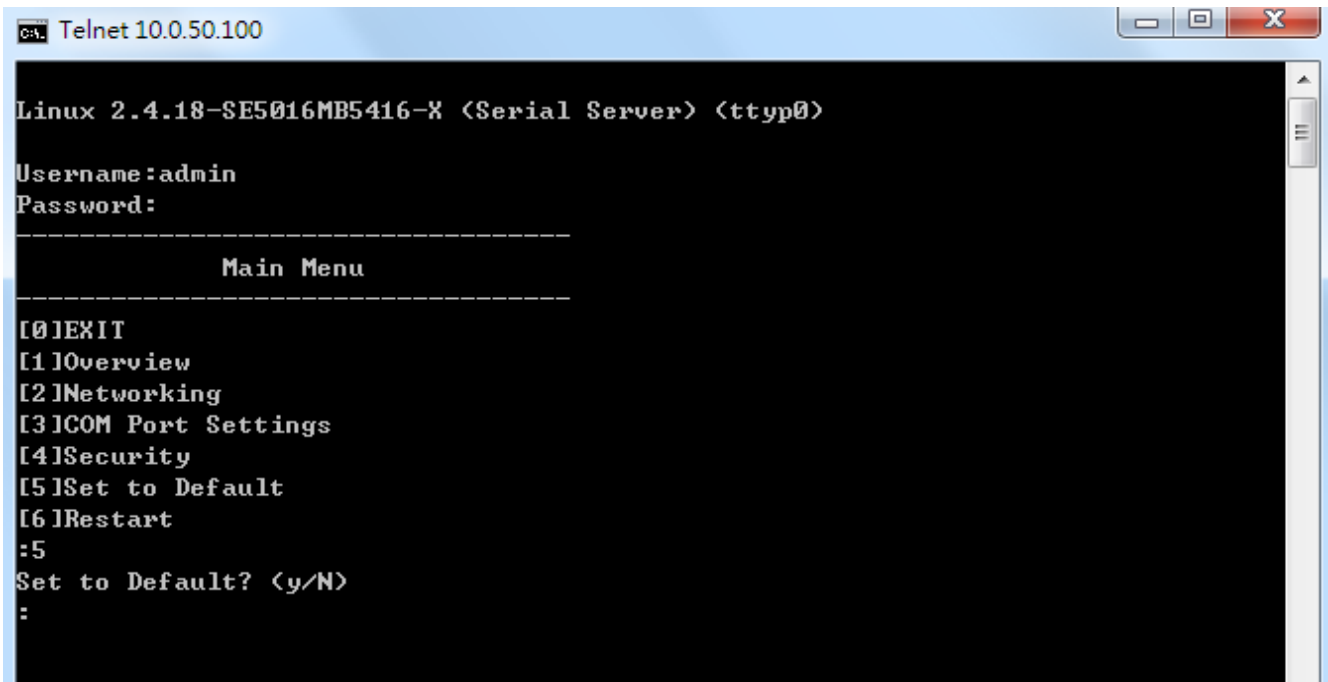

```
C:\> Telnet 10.0.50.100

Linux 2.4.18-SE5016MB5416-X <Serial Server> <ttyp0>

Username: admin
Password:

-----
                Main Menu
-----

[0]EXIT
[1]Overview
[2]Networking
[3]COM Port Settings
[4]Security
[5]Set to Default
[6]Restart
=:5
Set to Default? <y/N>
:
```

Fig. 6.22 Factory Default Setting Selection

Restart

Main Screen → **[6] Restart** as shown in Fig. 6.23, (a more detailed description of this section is given in [Sec.3.11.](#))

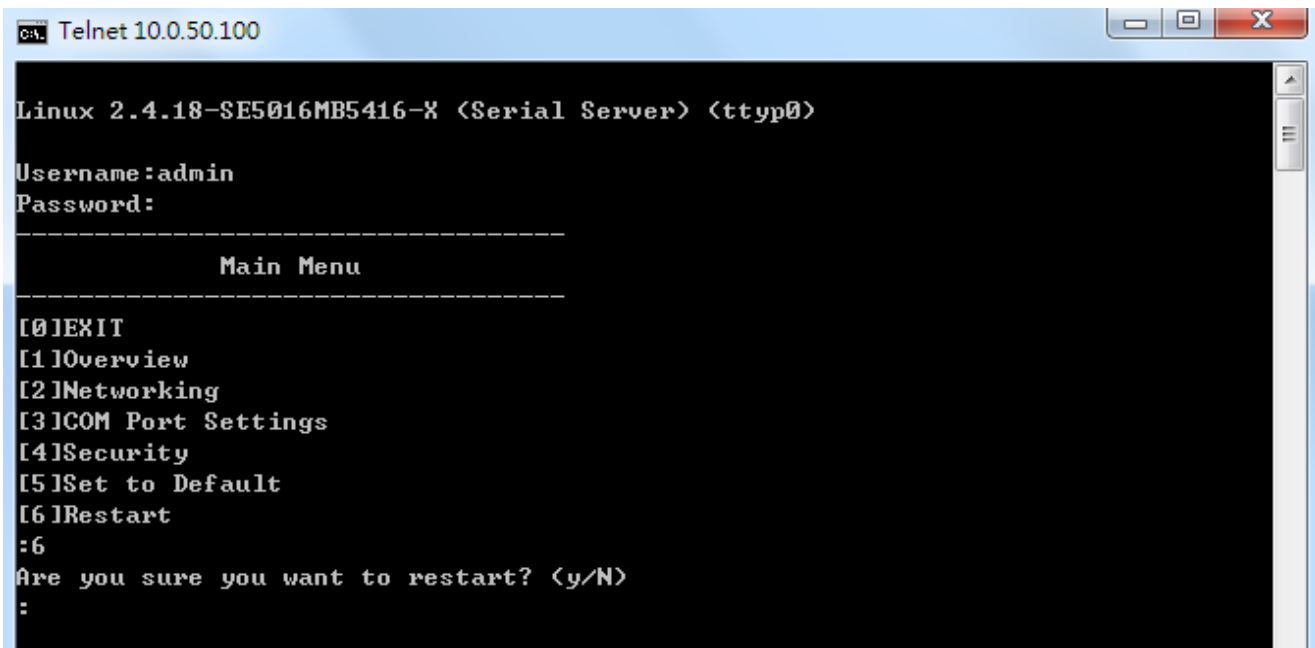

```

Telnet 10.0.50.100
Linux 2.4.18-SE5016MB5416-X <Serial Server> <ttyp0>
Username: admin
Password:
-----
                Main Menu
-----
[0]EXIT
[1]Overview
[2]Networking
[3]COM Port Settings
[4]Security
[5]Set to Default
[6]Restart
:6
Are you sure you want to restart? <y/N>
:
```

Fig. 6.23 Restart Menu Selection

Warranty

Limited Warranty Conditions

Products supplied by Atop Technologies Inc. are covered in this warranty for undesired performance or defects resulting from shipping, or any other event deemed to be the result of Atop Technologies Inc. mishandling. The warranty doesn't cover; however, equipment which has been damaged due to accident, misuse, abuse, such as:

- Use of incorrect power supply, connectors, or maintenance procedures
- Use of accessories not sanctioned by us
- Improper or insufficient ventilation
- Improper or unauthorized repair
- Replacement with unauthorized parts
- Failure to follow our operating Instructions
- Fire, flood, "Act of God", or any other contingencies beyond our control.

RMA and Shipping Reimbursement

- Customers must always obtain an authorized "**RMA**" number from us before shipping the goods to be repaired.
- When in normal use, a sold product shall be replaced with a new one within 3 months upon purchase. The shipping cost from the customer to us will be reimbursed.
- After 3 months and still within the warranty period, it is up to us whether to replace the unit with a new one; normally, as long as a product is under warranty, all parts and labor are free-of-charge to the customers.
- After the warranty period, the customer shall cover the cost for parts and labor.
- Three months after purchase, the shipping cost from the customer to us will not be reimbursed, but the shipping costs from us to the customer will be paid by us.

Limited Liability

Atop Technologies Inc. shall not be held responsible for any consequential losses from using our products.

Warranty

Atop Technologies Inc. provides a 5-years maximum warranty for Modbus Gateway products.