

# MAXIM

## MAX9856 Evaluation Kit

Evaluates: MAX9856

### General Description

The MAX9856 evaluation kit (EV kit) consists of a MAX9856 evaluation board and software. The MAX9856 EV kit is a fully assembled and tested PCB that evaluates the MAX9856 high-performance, low-power stereo audio CODEC with microphone inputs, DirectDrive® headphone amplifiers, and stereo line outputs. The EV kit is designed to send and receive digital audio data in the Sony/Philips digital interface (S/PDIF) format and can be optionally configured to communicate using generic digital audio or I<sup>2</sup>S-compatible signals. The EV kit provides RCA jacks for connecting analog input signals, analog output signals, and digital S/PDIF signals. A 3.5mm headphone jack provides easy connection of headphones to the circuit board. Another 3.5mm microphone jack provides easy connection of microphones to the circuit board.

The MAX9856 EV kit includes Windows® 2000-, Windows XP®, and Windows Vista®-compatible software that provides a simple graphical user interface (GUI) for exercising the features of the MAX9856. The EV kit is connected to a PC through a USB cable.

### Features

- ◆ USB Connectivity (No External Power Supply Required)
- ◆ Electrical S/PDIF Input/Output (with TOSLINK Option)
- ◆ On-Board 12MHz Crystal Clock Oscillator
- ◆ On-Board S/PDIF Digital Audio Receiver
- ◆ On-Board S/PDIF Digital Audio Transmitter
- ◆ On-Board Power-Management IC
- ◆ Isolation Header for Direct Communication with the MAX9856 I<sup>2</sup>C and Digital Audio Interfaces
- ◆ Easy-to-Use Menu-Driven Software
- ◆ Fully Assembled and Tested
- ◆ Windows 2000-, Windows XP-, and Windows Vista-Compatible Evaluation Software

### Ordering Information

PART	TYPE	PC INTERFACE
MAX9856EVKIT+	EV Kit	USB

+Denotes lead(Pb)-free and RoHS compliant.

### System Diagram

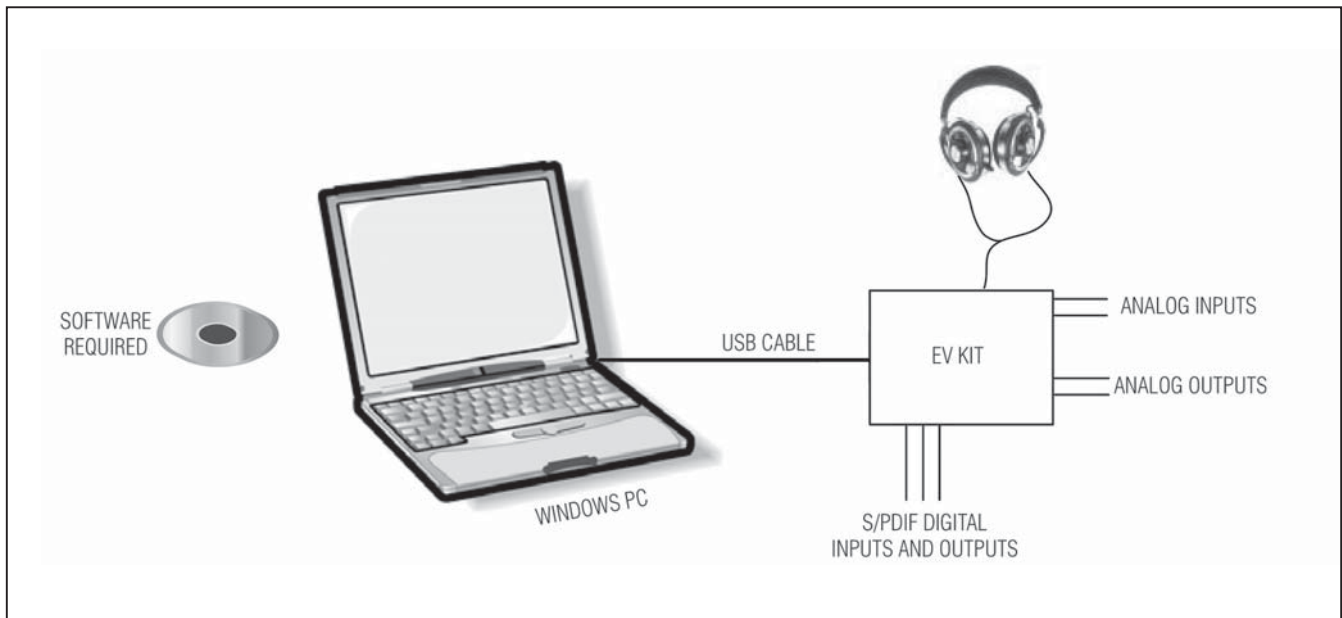

DirectDrive is a registered trademark of Maxim Integrated Products, Inc.

Windows, Windows XP, and Windows Vista are registered trademarks of Microsoft Corp.

# MAX9856 Evaluation Kit

## Component List

DESIGNATION	QTY	DESCRIPTION
<b>REQUIRED COMPONENTS</b>		
C27, C31	2	10 $\mu$ F $\pm$ 10%, 10V X5R ceramic capacitors (0805) TDK C2012X5R1A106K
C28, C32	2	0.1 $\mu$ F $\pm$ 10%, 16V X7R ceramic capacitors (0603) TDK C1608X7R1C104K
C29, C30	2	4.7 $\mu$ F $\pm$ 20%, 6.3V X5R ceramic capacitors (0603) TDK C1608X5R0J475M
C33–C36, C38, C39, C40, C43, C44, C45, C74, C78, C81, C85	14	1 $\mu$ F $\pm$ 10%, 10V X7R ceramic capacitors (0603) TDK C1608X7R1A105K
R13	1	10k $\Omega$ $\pm$ 5% resistor (0603)
<b>SUPPORT COMPONENTS</b>		
C1, C12, C14, C42, C75, C79, C83, C86, C88	9	10 $\mu$ F $\pm$ 10%, 10V X5R ceramic capacitors (0805) TDK C2012X5R1A106K
C2, C3	2	22pF $\pm$ 5%, 50V C0G ceramic capacitors (0603) TDK C1608C0G1H220J
C4	1	0.033 $\mu$ F $\pm$ 10%, 25V X7R ceramic capacitor (0603) TDK C1608X7R1E333K
C5–C10, C17, C18, C46, C48, C51, C53, C56, C59, C77	15	0.1 $\mu$ F $\pm$ 10%, 16V X7R ceramic capacitors (0603) TDK C1608X7R1C104K
C11, C47, C50, C52, C55, C57, C58, C66, C67, C73, C87	11	0.01 $\mu$ F $\pm$ 5%, 25V C0G ceramic capacitors (0603) TDK C1608C0G1E103J
C13, C37, C41, C64, C65, C68, C71, C72, C76, C80, C82, C84, C89	13	1 $\mu$ F $\pm$ 10%, 10V X7R ceramic capacitors (0603) TDK C1608X7R1A105K
C15, C16	2	10pF $\pm$ 5%, 50V C0G ceramic capacitors (0603) TDK C1608C0G1H100J
C49	0	Not installed, ceramic capacitor (0603)

DESIGNATION	QTY	DESCRIPTION
C54	1	0.22 $\mu$ F $\pm$ 10%, X7R 10V ceramic capacitor (0603) TDK C1608X7R1A224K
C69	1	1000pF $\pm$ 5%, 50V C0G ceramic capacitor (0603) TDK C1608C0G1H102J
C70	1	0.022 $\mu$ F $\pm$ 5%, 50V C0G ceramic capacitor (1206) TDK C3216C0G1H223J
D1	1	Green LED (0603)
D2	1	Red LED (0603)
FB1	1	Ferrite bead TDK MMZ1608R301A (0603) or equivalent
J1	1	USB type-B right-angle PCB mount receptacle
J2	0	Not installed, 10-pin dual-row header (2 x 5)
J3	1	Switched stereo headphone jack (3.5mm)
J4, J6	2	White phono jacks (side-entry PCB mount)
J5, J7	2	Red phono jacks (side-entry PCB mount)
J8	1	Stereo headphone jack (3.5mm)
J9	0	Not installed, 6-pin single-row header (1 x 6)
J10	1	SMA PC-mount connector
J11, J12	2	Black phono jacks (side-entry PCB mount)
J13	0	Not installed, digital audio optical receiver Toshiba TORX147L
J14	0	Not installed, digital audio optical transmitter Toshiba TOTX147L
JU1	1	27-pin, three-row header (3 x 9)
JU2	1	3-pin header

# MAX9856 Evaluation Kit

**Evaluates: MAX9856**

## Component List (continued)

DESIGNATION	QTY	DESCRIPTION
JU4–JU10	7	2-pin headers
L1	1	3.3 $\mu$ H $\pm$ 5%, 270mA inductor (1812) Coilcraft 1812CS-332XJLB
L2	1	47 $\mu$ H $\pm$ 5% 200mA inductor (1812) Coilcraft 1812LS-473XJLB
R1, R2	2	27 $\Omega$ $\pm$ 5% resistors (0603)
R3, R11, R12	3	1.5k $\Omega$ $\pm$ 5% resistors (0603)
R4	1	470 $\Omega$ $\pm$ 5% resistor (0603)
R5, R16, R17, R22, R44	5	2.2k $\Omega$ $\pm$ 5% resistors (0603)
R6, R23, R28–R34	9	10k $\Omega$ $\pm$ 5% resistors (0603)
R7, R8	2	220 $\Omega$ $\pm$ 5% resistors (0603)
R9	1	0 $\Omega$ $\pm$ 5% resistor (0603)
R10	1	3.01k $\Omega$ $\pm$ 1% resistor (0603)
R14, R18, R19, R24	4	75 $\Omega$ $\pm$ 5% resistors (0603)
R15	1	1k $\Omega$ $\pm$ 5% resistor (0603)
R20, R21	0	Not installed, resistors (0603)
R25, R26	2	100k $\Omega$ $\pm$ 5% resistors (0603)
R27, R37, R38, R40	4	47k $\Omega$ $\pm$ 5% resistors (0603)
R35	1	107 $\Omega$ $\pm$ 1% resistor (0603)
R36	1	243 $\Omega$ $\pm$ 1% resistor (0603)
R39	1	510 $\Omega$ $\pm$ 5% resistor (0603)
R41	1	75 $\Omega$ $\pm$ 1% resistor (0603)
R42	1	2.4k $\Omega$ $\pm$ 5% resistor (0603)
T1	1	Digital audio transformer Scientific Conversion, Inc. SC979-03LF
TP1	0	Not installed, test point
U1	1	Stereo audio CODEC (40 TQFN-EP*) Maxim MAX9856ETL+

DESIGNATION	QTY	DESCRIPTION
U2	1	Microcontroller (68 QFN-EP*) Maxim MAXQ2000-RAX
U3	1	Power management IC (20 TQFN) Maxim MAX1799ETP+
U4	1	LDO regulator (5 SC70) Maxim MAX8511EXK25+
U5	1	USB-to-UART converter FTDI FT232BL
U6	1	93C46 type 3-wire EEPROM Atmel AT93C46A-10SU-2.7
U11	1	I <sup>2</sup> C-to-parallel converter (16 QSOP) Maxim MAX1609EEE+
U13	1	Phase-locked loop
U15	1	192kHz digital audio transmitter Cirrus Logic CS8406-CZZ
U16	1	192kHz digital audio receiver Cirrus Logic CS8416-CZZ
U17	1	CPLD Xilinx XC9536XL-7VGQ44C
Y1	1	16MHz crystal Citizen HCM49-16.000MABJ-UT
Y2	1	6MHz crystal Citizen HCM49-6.000MABJ-UT
Y3	0	Not installed, 32.768kHz crystal
Y4	1	3.3V, 12MHz crystal clock oscillator Citizen CSX750FBC12.000000M-UT
—	17	Shunts
—	1	PCB: MAX9856 EVALUATION KIT+

\*EP = Exposed pad.

## Component Suppliers

SUPPLIER	PHONE	WEBSITE
Coilcraft, Inc.	847-639-6400	www.coilcraft.com
TDK Corp.	847-803-6100	www.component.tdk.com

**Note:** Indicate that you are using the MAX9856 when contacting these component suppliers.

# MAX9856 Evaluation Kit

## MAX9856 EV Kit Files

FILE	DESCRIPTION
INSTALL.EXE	Installs the EV kit files on your computer
MAX9856.EXE	Application program
FTD2XX.INF	USB device driver file
UNINST.INI	Uninstalls the EV kit software
USB_Driver_Help.PDF	USB driver installation help file

## Quick Start

### Recommended Equipment

- User-supplied Windows 2000, Windows XP, or Windows Vista PC with a spare USB port
- One standard USB peripheral cable
- One pair of headphones (16Ω or greater)
- One analog audio source
- Three RCA interconnect cables

Refer to the MAX9856 IC data sheet while using this EV kit for detailed descriptions of the CODEC's features.

**Note:** In the following sections, software-related items are identified by bolding. Text in **bold** refers to items directly from the EV kit software. Text in **bold and underlined** refers to items from the Windows operating system.

### Procedure

The MAX9856 EV kit is fully assembled and tested. Follow the steps below to verify board operation in an analog input, digital loopback, and analog output mode. Once the board has been set up, verify that the board is operating properly before beginning an evaluation.

- 1) Verify that all the jumpers are set in their default positions. See Table 2 for default shunt positions.
- 2) Connect a single RCA cable between the S/PDIF IN jack (J12) and the S/PDIF OUT jack (J11).
- 3) Connect a stereo analog audio source to LINEIN1 and LINEIN2.
- 4) Insert a pair of headphones into the HEADPHONE jack (J3).
- 5) Enable the stereo audio source output.
- 6) Visit ([www.maxim-ic.com/evkitsoftware](http://www.maxim-ic.com/evkitsoftware)) to download the latest version of the EV kit software, 9856Rxx.ZIP.
- 7) Install the MAX9856 evaluation software on your computer by running the INSTALL.EXE program. The program files are copied and icons are created in the Windows **Start** menu.
- 8) Connect the USB cable from the PC to the MAX9856 EV kit board.
- 9) A **Building Driver Database** window pops up in addition to a **New Hardware Found** message when installing the USB driver for the first time. If you do not see a window that is similar to the one described above after 30s, and the device is not functional, remove the USB cable from the MAX9856 EV kit board and reconnect it. Administrator privileges are required to install the USB device driver on Windows 2000/XP. Refer to the USB\_Driver\_Help.PDF document included with the software if you have trouble during this step.
- 10) Follow the directions of the **Add New Hardware Wizard** to install the USB device driver. Choose the **Search for the Best Driver for your Device** option. Specify the location of the device driver as **C:\Program Files\MAX9856** (default installation directory) using the **Browse** button.
- 11) Start the MAX9856 program by opening its icon in the **Start** menu. The setup wizard **Step 1 of 2** window appears (Figure 1).
- 12) In the **Line Inputs** group box, check **LINEIN1/LINEIN2**. In the **Digital Audio Inputs** group box, select **S/PDIF**.
- 13) Click the **Continue** button. The setup wizard **Step 2 of 2** window appears, as shown in Figure 2.
- 14) In the **Analog Outputs** group box, check **Headphone**. In the **Digital Audio Outputs** group box, select **S/PDIF**.
- 15) Click the **Finish** button. The software main window appears (Figure 3).
- 16) Verify that the **Hardware: connected** message is displayed in the status bar of the software main window. This indicates the proper operation of the EV kit.
- 17) Audio should be at the headphones in approximately 2s.
- 18) Click the **OK** button when a reminder window appears.

# MAX9856 Evaluation Kit

## Detailed Description of Software

### Setup Wizard

When the program starts up, a software setup wizard helps the user set up the software quickly. The wizard collects information about the EV kit's audio inputs and outputs. The software then configures the EV kit automatically for the user.

### Software Main Window

The left-hand side of the main window (Figure 3) includes 10 tabs. On each tab, the user can exercise a group of related configurations. Each control on the GUI generates the expected I<sup>2</sup>C write operation to update the internal registers of the MAX9856 and other I<sup>2</sup>C devices on the EV kit.

The right-hand side of the main window displays the data sent to and read from the MAX9856, as well as the status of the MAX9856. Also, the S/PDIF receiver and transmitter can be enabled and disabled here.

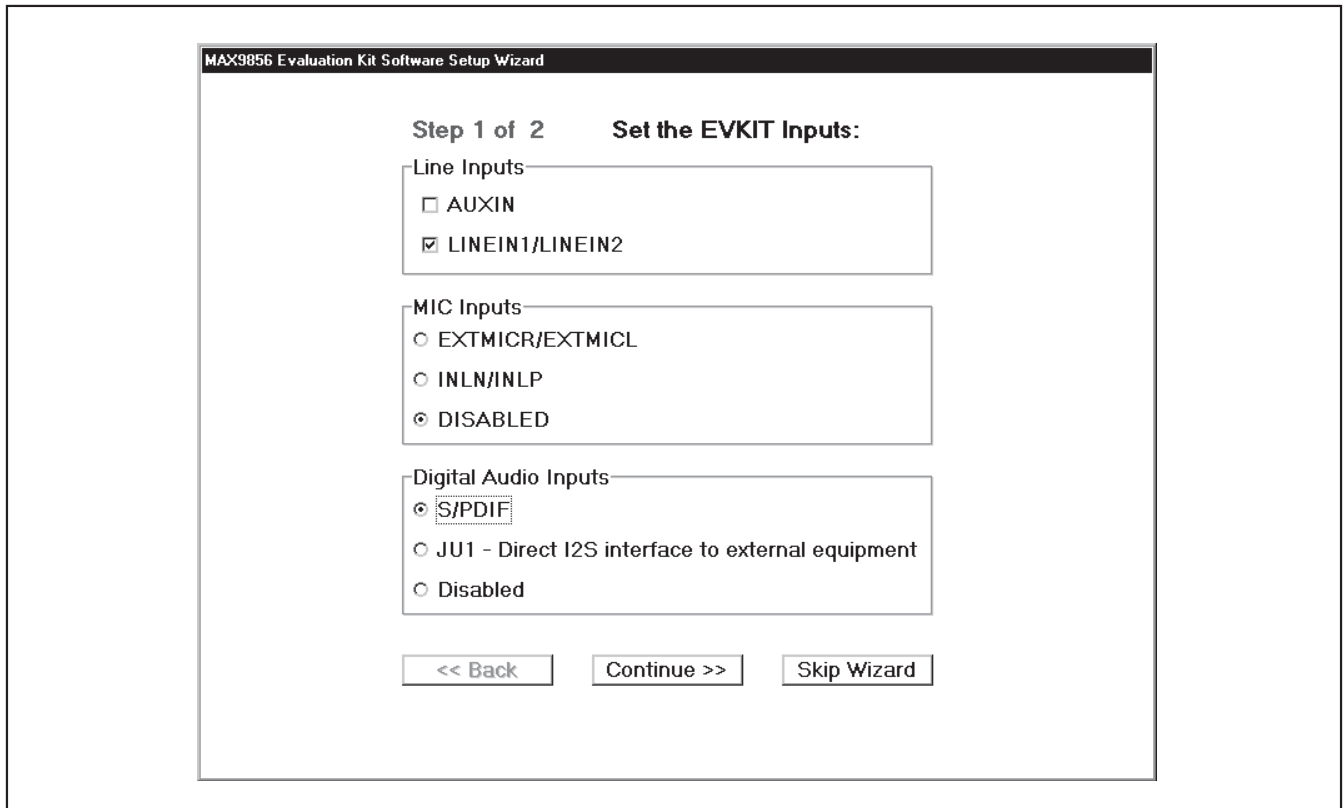

Figure 1. MAX9856 Evaluation Software (Setup Wizard Step 1 of 2)

# MAX9856 Evaluation Kit

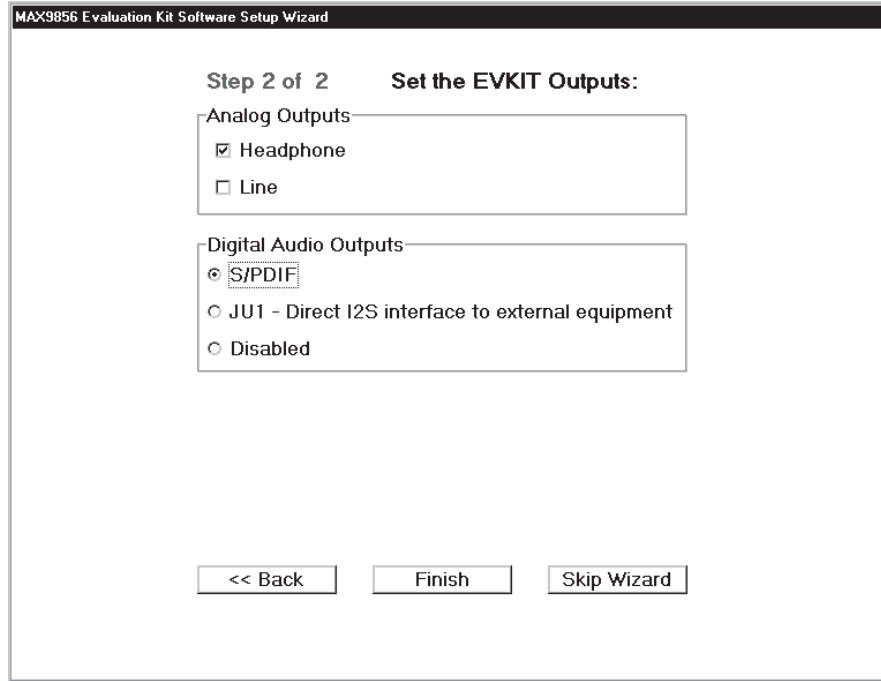

Figure 2. MAX9856 Evaluation Software (Setup Wizard Step 2 of 2)

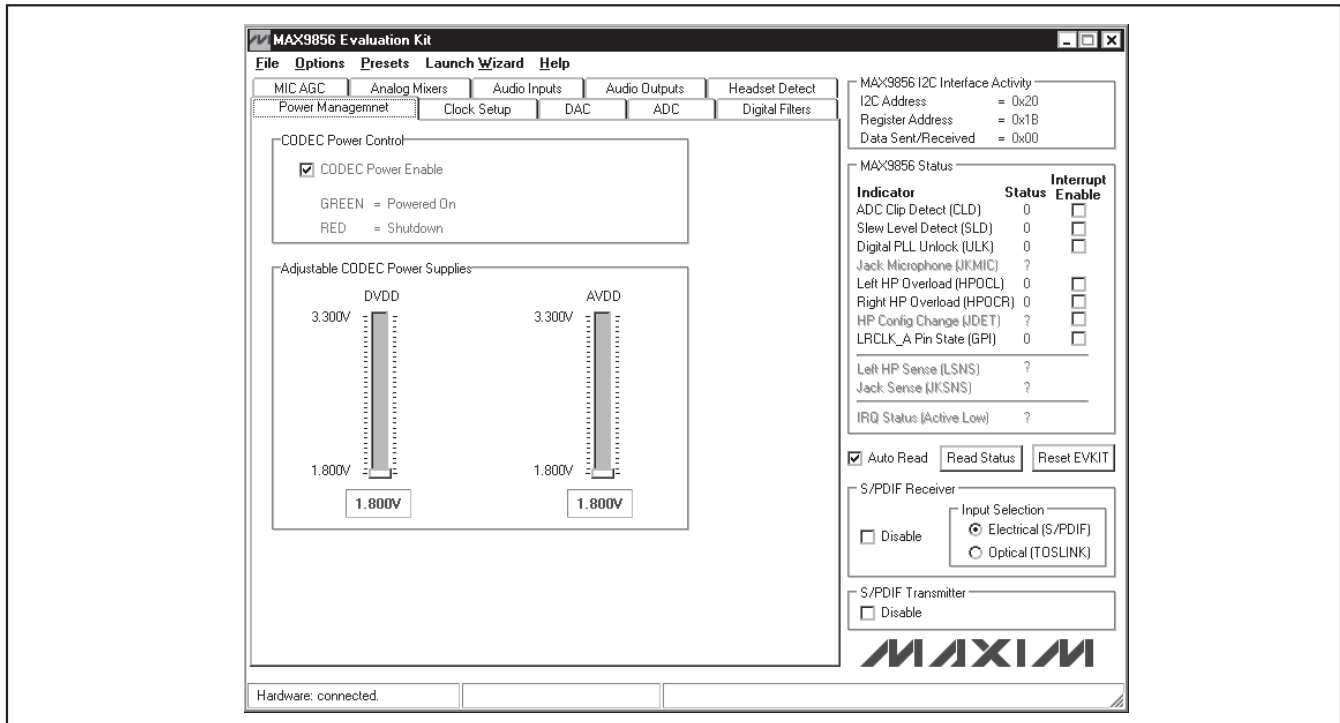

Figure 3. MAX9856 Evaluation Software (Main Window)

# MAX9856 Evaluation Kit

Evaluates: MAX9856

## MAX9856 I<sup>2</sup>C Interface Activity

The **MAX9856 I<sup>2</sup>C Interface Activity** group box (Figures 3 and 4) indicates the **Register Address** and **Data Sent/Received** to or from the register. Use this data to verify that a proper value is written to or read from the MAX9856. Some operations may include several continuous register read or write, but only the last register read or write operation is displayed.

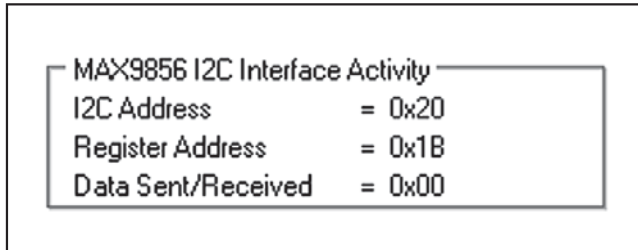

Figure 4. MAX9856 Evaluation Software (MAX9856 I<sup>2</sup>C Interface Activity Group Box)

## MAX9856 Status

The current status is reported in the **MAX9856 Status** group box (Figures 3 and 5). Click the **Read Status** button to poll the status of the MAX9856. Check the **Interrupt Enable** checkbox next to the desired indicator to trigger hardware interrupts when the alert condition occurs. If an interrupt is generated, the **IRQ Status (Active Low)** indicator label displays a status "0" in red color.

## S/PDIF Receiver

The **S/PDIF Receiver** group box (Figures 3 and 6) controls the action of the on-board S/PDIF receiver. Check **Disable** to disable the receiver. Select the electrical or optical input by clicking the appropriate radio button.

## S/PDIF Transmitter

The **S/PDIF Transmitter** group box (Figure 3) controls the action of the on-board S/PDIF transmitter. Check **Disable** to disable the transmitter. Both electrical and optical outputs are simultaneously available.

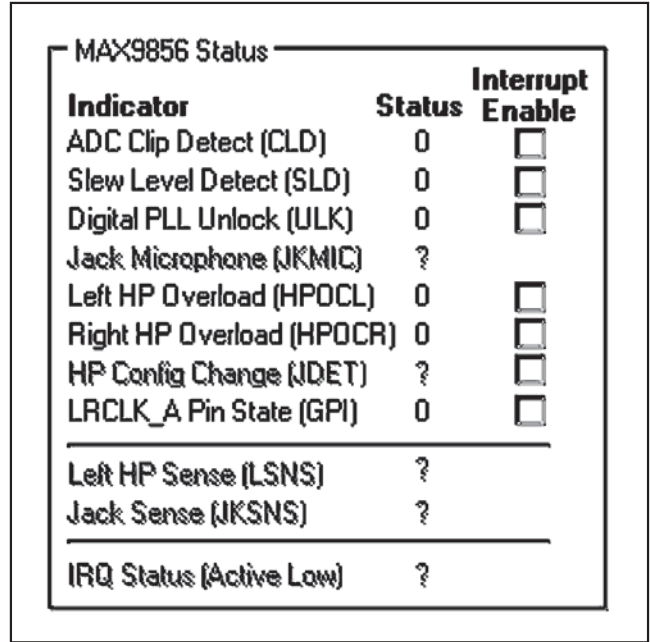

Figure 5. MAX9856 Evaluation Software (MAX9856 Status Group Box)

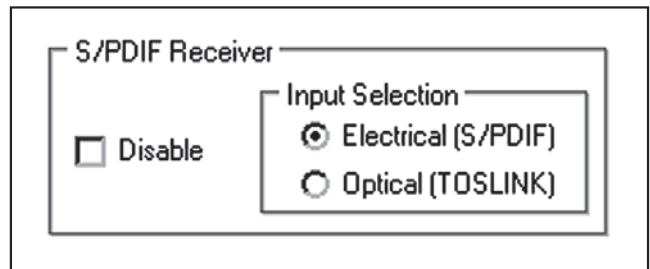

Figure 6. MAX9856 Evaluation Software (MAX9856 S/PDIF Receiver Group Box)



# MAX9856 Evaluation Kit

## Options Menu

### Advanced User Interface

In addition to the main control interface, direct I<sup>2</sup>C commands can be issued to any part on the EV kit through the **Interface (Advanced Users)** menu item available from the **Options** menu bar. The 2-wire interface diagnostics allow I<sup>2</sup>C operations, such as read byte and write byte, to be executed. Uncheck the **Auto Read** checkbox before using the 2-wire interface diagnostics. The I<sup>2</sup>C dialog boxes accept numeric data in binary, decimal, or hexadecimal. Hexadecimal numbers should be prefixed by \$ or 0x. Binary numbers must be exactly eight digits. See Figure 7 for an example of this control method.

### View Register Settings

From the **Options** menu bar, select **View Register Settings** to display the current register settings of the MAX9856 (Figure 8) and optionally save them to a text file.

### Save Settings ... and Load Settings ...

From the **Options** menu bar, select **Save Settings ...** to save the current EV kit configuration to a text file that can be loaded at a later time. Select **Load Settings ...** to reload settings from a saved file.

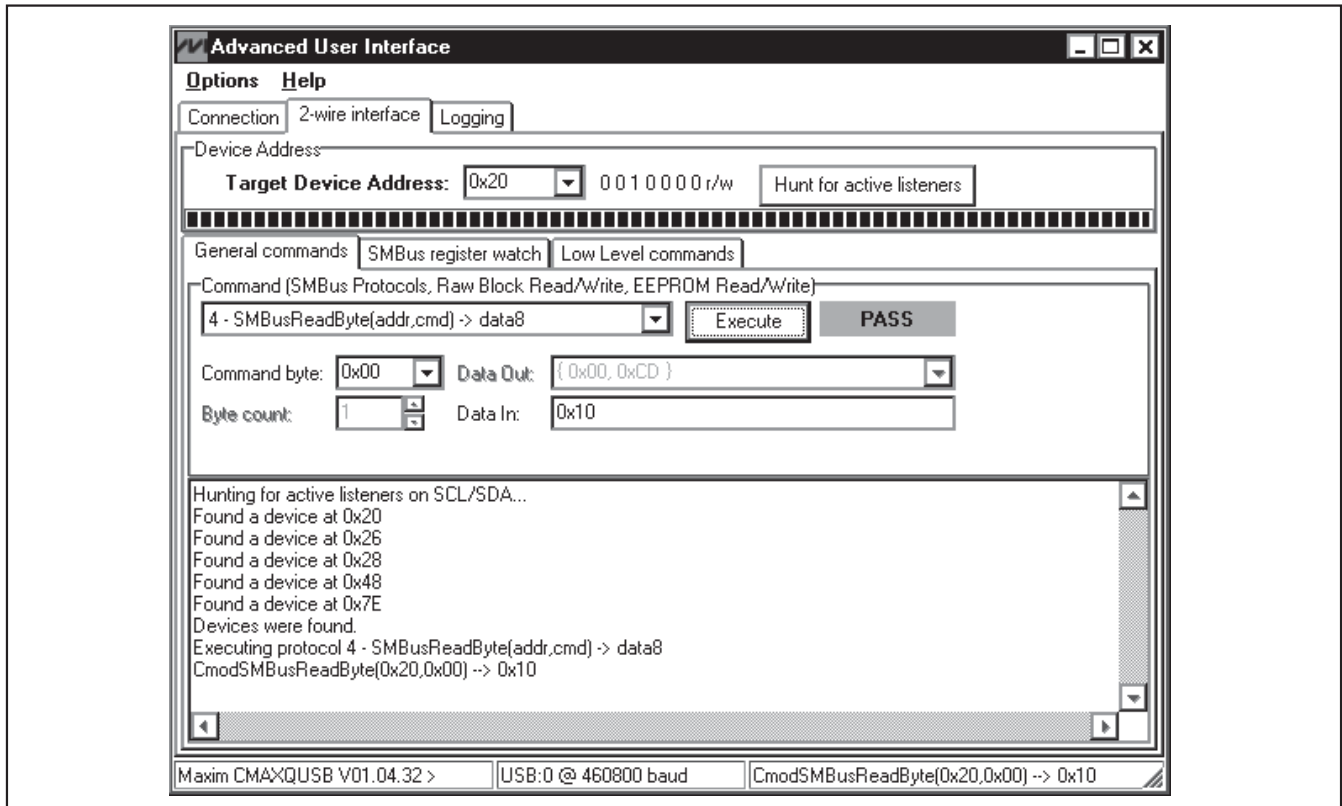

Figure 7. Advanced User Interface Window (2-Wire Interface Tab)



# MAX9856 Evaluation Kit

Evaluates: MAX9856

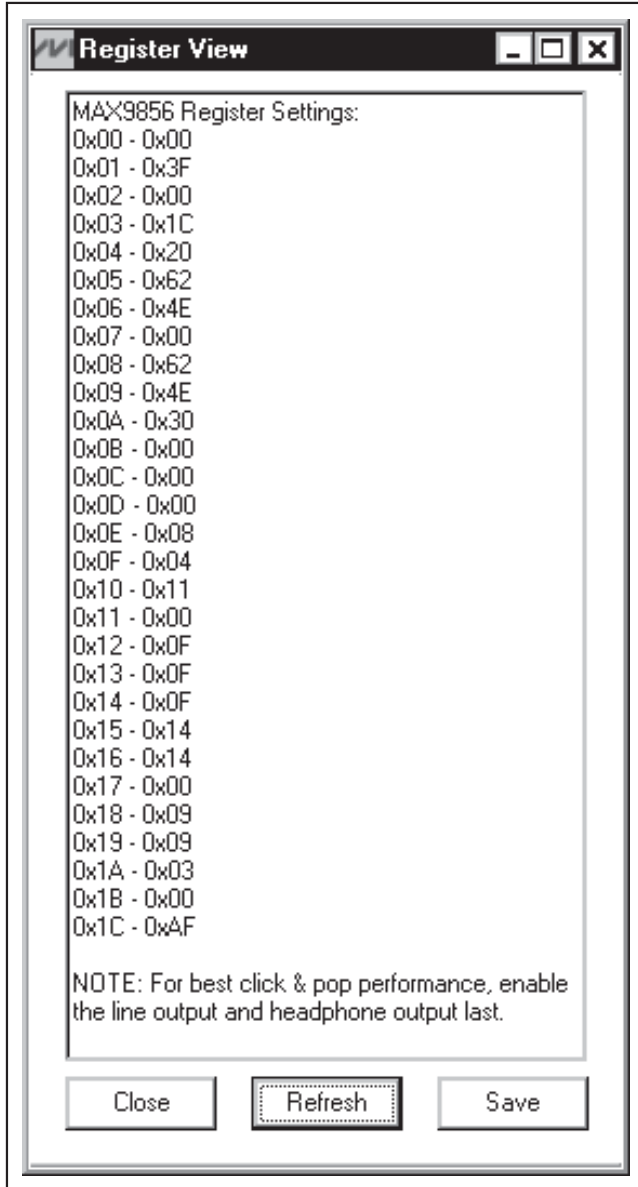

Figure 8. MAX9856 Evaluation Software (MAX9856 Register View Window)

### Presets Menu

Click on the **Presets** menu item shown in Figure 3 to access seven preconfigured operating modes for the EV kit. These presets quickly configure the MAX9856 in the operating mode listed in Table 1. Once a preset has been selected, use the main interface to optimize the settings as desired.

Table 1. EV Kit Preset Configurations

SETTING	DESCRIPTION
48kHz digital audio playback	Inputs: Digital audio on S/PDIF IN Outputs: Stereo headphones and line outputs
48kHz digital and analog audio playback	Inputs: Digital audio on S/PDIF IN and analog line inputs Outputs: Stereo headphones and line outputs
32kHz microphone record	Inputs: Stereo external microphones Outputs: Digital audio on S/PDIF OUT
Analog playback	Inputs: Analog line inputs Outputs: Stereo headphones and line outputs
48kHz digital audio loopback through on-board jumper JU1	Inputs: Analog line inputs Loopback: I <sup>2</sup> S digital audio output connected to I <sup>2</sup> S input operating at 48kHz stereo audio mode Outputs: Stereo headphones and line outputs (on JU1, remove the shunts on row 6 and row 7 and connect pin 17 to pin 20 directly)
32kHz microphone digital loopback	Inputs: Stereo external microphones Loopback: I <sup>2</sup> S digital audio output connected to I <sup>2</sup> S input operating at 32kHz stereo audio mode Outputs: Stereo headphones and line outputs (on JU1, remove the shunts on row 6 and row 7 and connect pin 17 to pin 20 directly)
48kHz digital audio loopback through on-board S/PDIF transceivers	Inputs: Analog line inputs Loopback: I <sup>2</sup> S digital audio output transmitted and received through on-board S/PDIF transceivers operating at 48kHz stereo audio mode Outputs: Stereo headphones and line outputs

### Launch Wizard Menu

Click on the **Launch Wizard** menu item shown in Figure 3 to launch the setup wizard and let the software configure the EV kit automatically.

### Power Management Tab

The **Power Management** tab (Figure 9) controls the MAX1799 power-management IC on the EV kit. Move the **DVDD** track bar to adjust the supply voltage for DVDD on the MAX9856. Move the **AVDD** track bar to adjust the supply voltage for AVDD and CPVDD on the MAX9856.

Check the **CODEC Power Enable** checkbox to turn on the MAX9856.

# MAX9856 Evaluation Kit

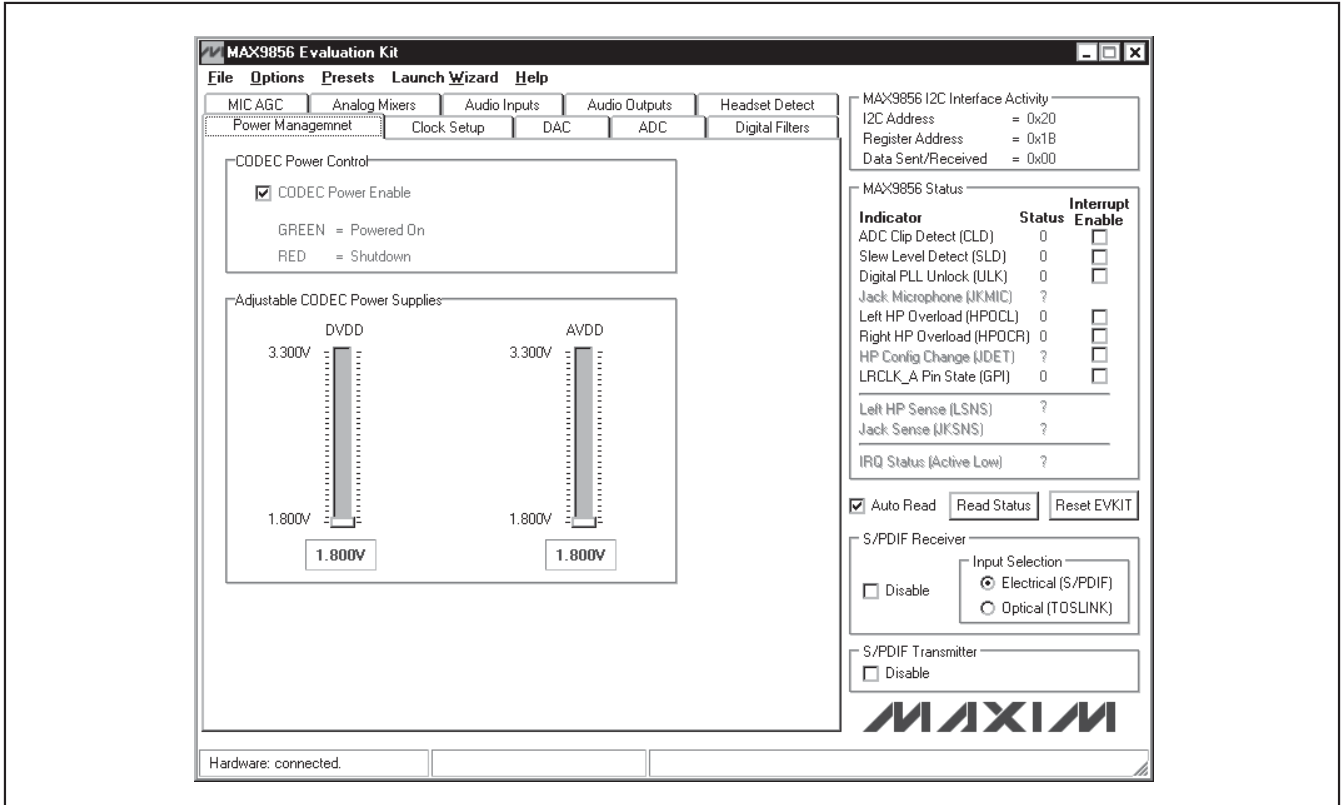

Figure 9. MAX9856 Evaluation Software (Power Management Tab)

## Clock Setup Tab

The **Clock Setup** tab (Figure 10) controls the master clock source for the MAX9856. Choose **Recovered Master Clock (10MHz - 60MHz)** when recovered clock from the S/PDIF receiver is used as the MAX9856 master clock. The master clock can also be chosen from the on-board 12MHz crystal or from an external clock applied on SMA connector J10. When an external master clock is selected, the user should type the exact value of the external supplied clock frequency in the **Frequency** edit box and then click the **Set** button.

The **MAX9856 Operation Mode** group box puts the MAX9856 into either master or slave mode.

## DAC Tab

The **DAC** tab (Figure 11) controls the functionality of the left- and right-channel DACs on the MAX9856.

The DACs can be shut down if they are not used. The right-channel DAC can only be enabled when the left-channel DAC is enabled. If the left DAC is disabled, the right DAC is disabled as well.

Check the **LRCLK\_D Invert** checkbox or the **BCLK Invert** checkbox to invert the waveform of the LRCLK or BCLK clock line on the I<sup>2</sup>S input interface. DAC modulation rate can be selected by clicking the **Modulator Rate** drop-down list. Check the **DAC Data Delay** checkbox to delay audio data one BCLK cycle after the frame clock. Check the **PCM Mode (Both DAC & ADC)** checkbox to set digital audio data in PCM format for

# MAX9856 Evaluation Kit

Evaluates: MAX9856

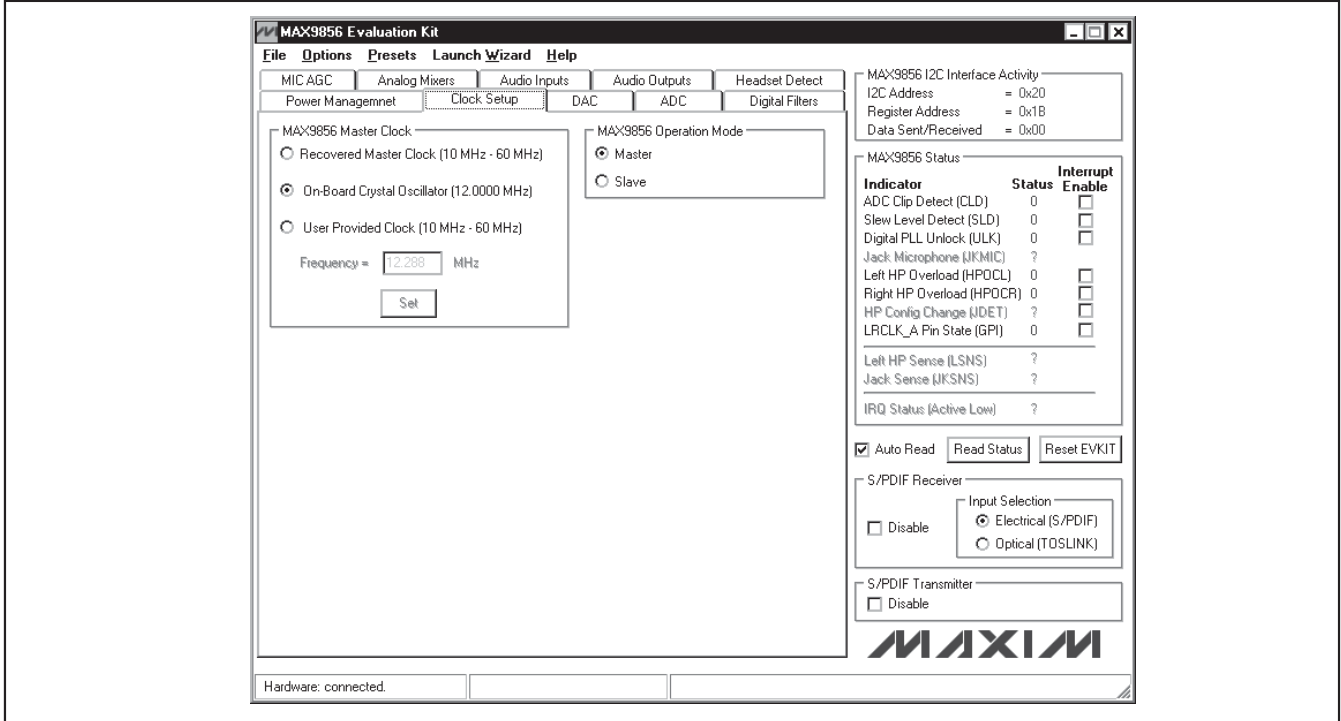

Figure 10. MAX9856 Evaluation Software (Clock Setup Tab)

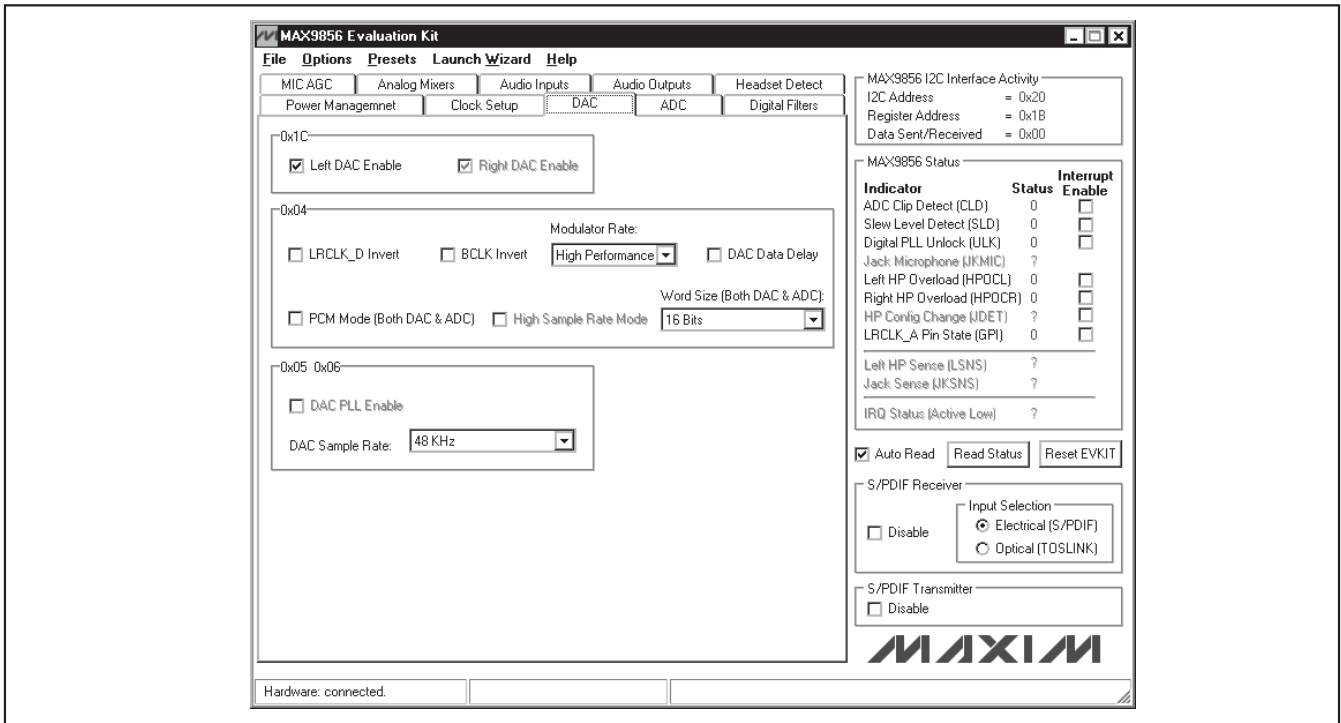

Figure 11. MAX9856 Evaluation Software (DAC Tab)

# MAX9856 Evaluation Kit

both the DACs and ADCs. (**Note:** The on-board S/PDIF transmitter and receiver do not support PCM mode.) The **High Sample Rate Mode** checkbox is automatically checked if DAC sample rate is greater than 50kHz. Click on the **Word Size (Both DAC & ADC)** drop-down list to select the DAC and ADC resolution to 16 or 18 bits per sample.

When the MAX9856 is in master mode, the DPLLEN bit is always set to 0. When the MAX9856 is in slave mode, the DPLLEN bit can be set to 1 or 0 by either checking or unchecking the **DAC PLL Enable** checkbox.

DAC sample rate can be selected by clicking the **DAC Sample Rate** drop-down list.

## ADC Tab

The **ADC** tab (Figure 12) controls the functionality of the left- and right-channel ADCs on the MAX9856.

The ADCs can be shut down if they are not used. The right-channel ADC can only be enabled when the left-channel ADC is enabled. If left ADC is disabled, the right ADC is disabled as well.

Check the **LRCLK\_A Invert** checkbox or **BCLK Invert** checkbox to invert the waveform of the LRCLK or BCLK clock line on the I<sup>2</sup>S output interface. Click **LRCLK\_A Pin Configuration** drop-down list to select the LRCLK\_A pin functionality. If the ADCs do not share the same sample frequency with the DACs, the ADCs' sample frequency can be set separately. When the

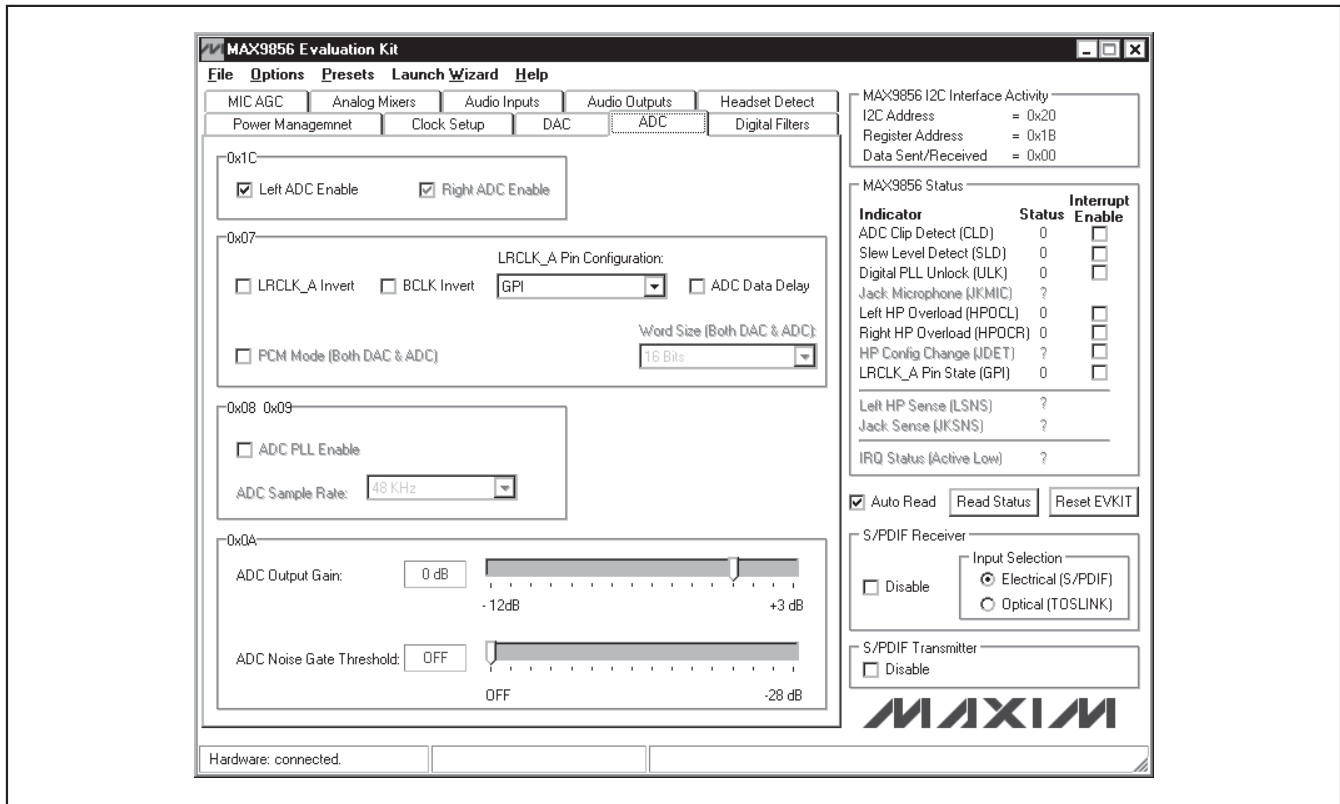

Figure 12. MAX9856 Evaluation Software (ADC Tab)

# MAX9856 Evaluation Kit

Evaluates: MAX9856

ADCs share the same sample frequency with the DACs, the LRCLK\_A pin can be used as a general-purpose IO (GPIO) pin. Check the **ADC Data Delay** checkbox to delay audio data one BCLK cycle after the frame clock. The PCM mode and word size control registers apply to both the ADCs and the DACs.

When the MAX9856 is in master mode, the APLEN bit is always set to 0. When the MAX9856 is in slave mode, the APLEN bit can be set to 1 or 0 by checking or unchecking the **ADC PLL Enable** checkbox.

The **ADC Output Gain** and the **ADC Noise Gate Threshold** can be set by moving their respective track bars.

## Digital Filters Tab

The MAX9856 includes digital first-order highpass filters for both the DACs input and the ADCs output. Based on the sample frequencies selected, the **DAC Input -3dB Cutoff Frequency** and the **ADC output -3dB Cutoff Frequency** can be set by moving their respective track bars (Figure 13).

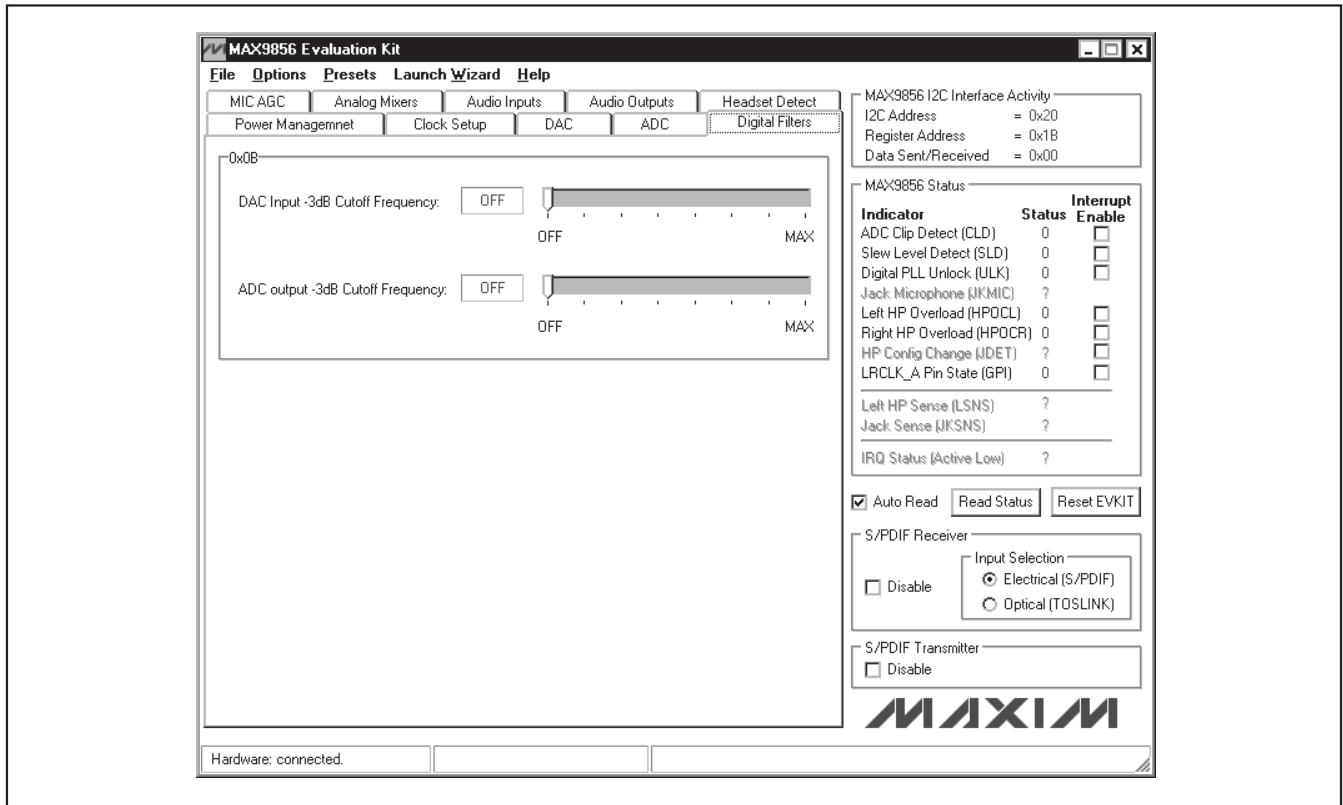

Figure 13. MAX9856 Evaluation Software (Digital Filters Tab)

# MAX9856 Evaluation Kit

## MIC AGC Tab

On the **MIC AGC** tab (Figure 14), the **AGC Release Time**, **Attack Time**, **Hold Time**, **AGC & Noise Gate Signal Source**, and **AGC Signal Threshold** can be configured. When AGC is enabled, the gain on the left microphone channel is automatically monitored.

## Analog Mixers Tab

The MAX9856 has two main analog mixers shown in Figure 15. The **Left/Right ADC Input Mixer** can select from **AUXAC**, **LINEIN1**, **LINEIN2**, **MICL**, and **MICR**. The **Left/Right Audio Output Mixer** can select from **MICL PGA Output**, **MICR PGA Output**, **LINEIN1**, **LINEIN2**, **DACL Output**, and **DACR Output**.

## Audio Inputs Tab

The MAX9856 includes various audio inputs and their gains are programmable. The **Digital Audio Input PGA**, **AUXIN PGA**, **LINEIN1/LINEIN2 PGA**, and **Left/Right MIC PGA** are set by moving their respective track bars, as shown in Figure 16.

Left and right microphone preamplifiers can be set in the **Left MIC Preamplifier** and **Right MIC Preamplifier** drop-down lists.

The microphones can be muted by checking the **Mute Left & Right MIC** checkbox. The **MICBIAS Voltage** can be selected from +1.5V or +2.4V (only when AVDD  $\geq$  2.7V). The left microphone input can be either a pseudo differential input (**MICL/MICGND**) or a differential input (**INLP/INLN**), while the right microphone input can only be a pseudo differential input (**MICR/MICGND**).

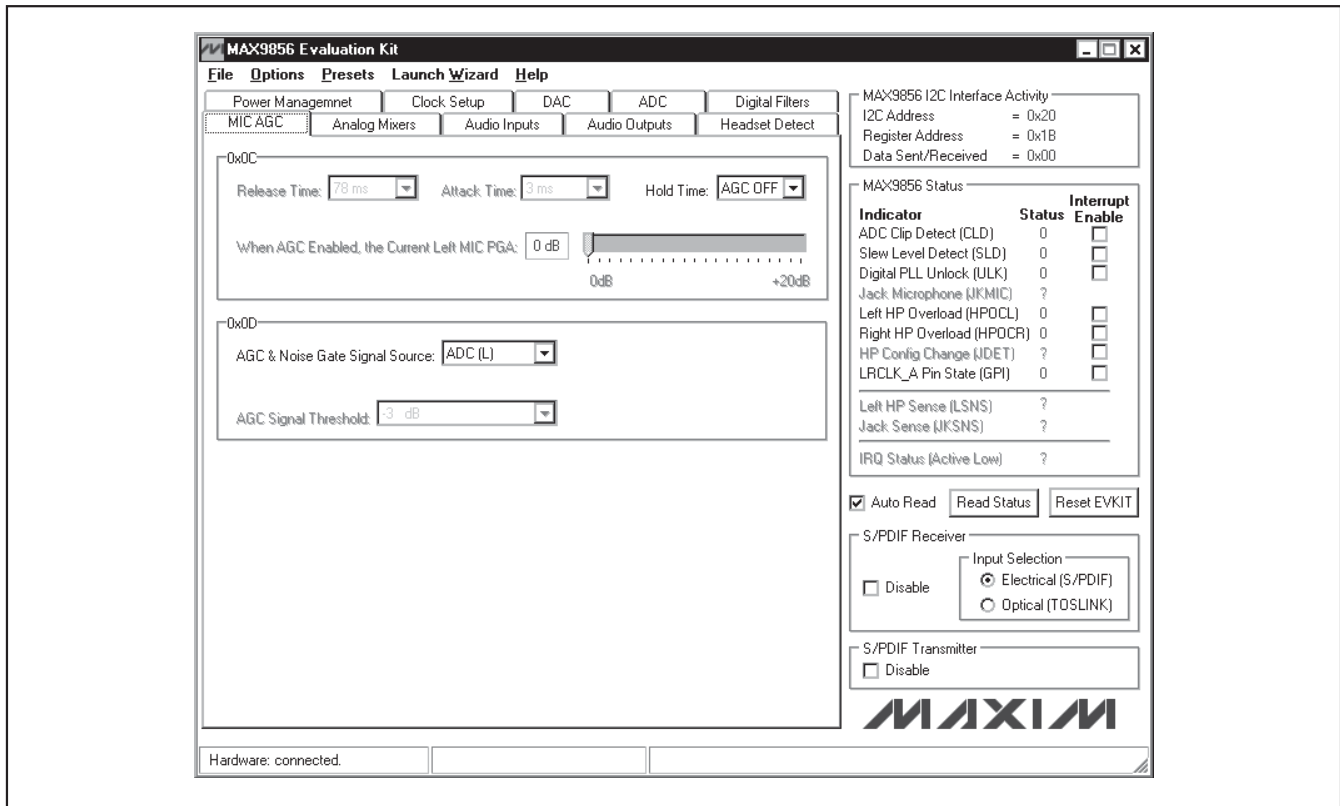

Figure 14. MAX9856 Evaluation Software (MIC AGC Tab)

# MAX9856 Evaluation Kit

Evaluates: MAX9856

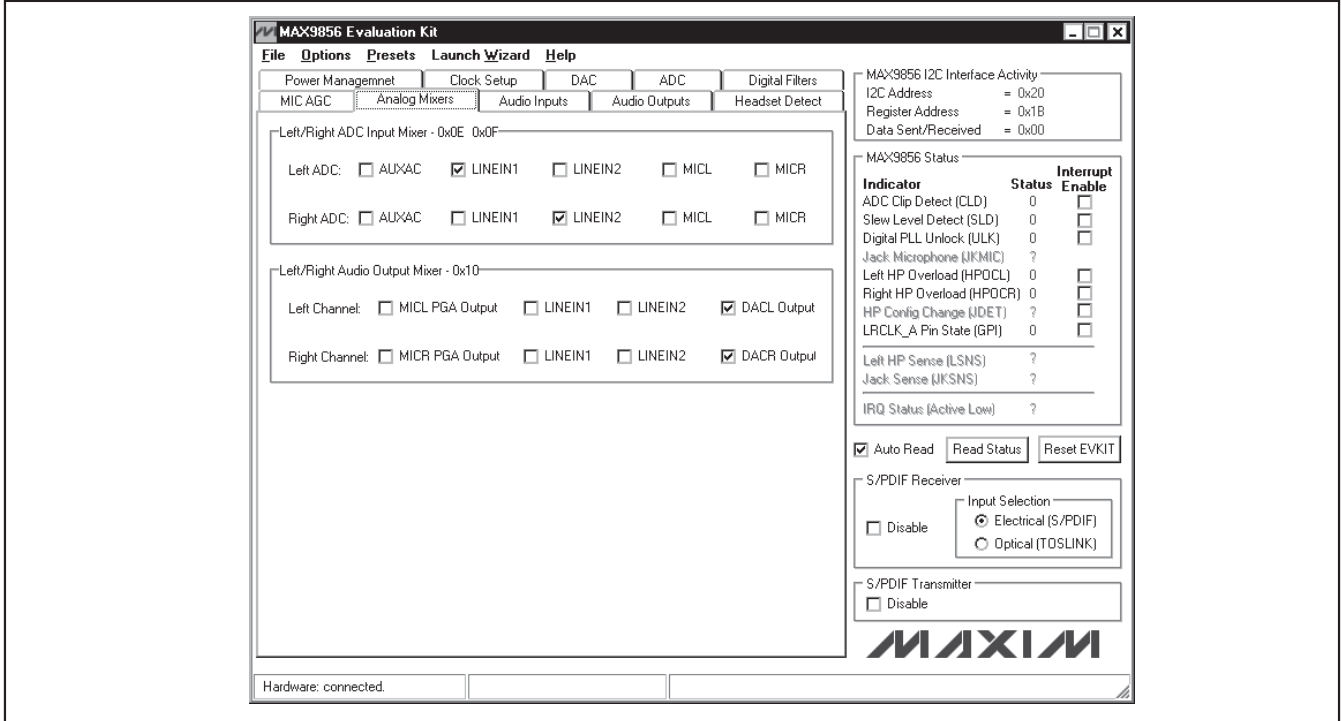

Figure 15. MAX9856 Evaluation Software (Analog Mixers Tab)

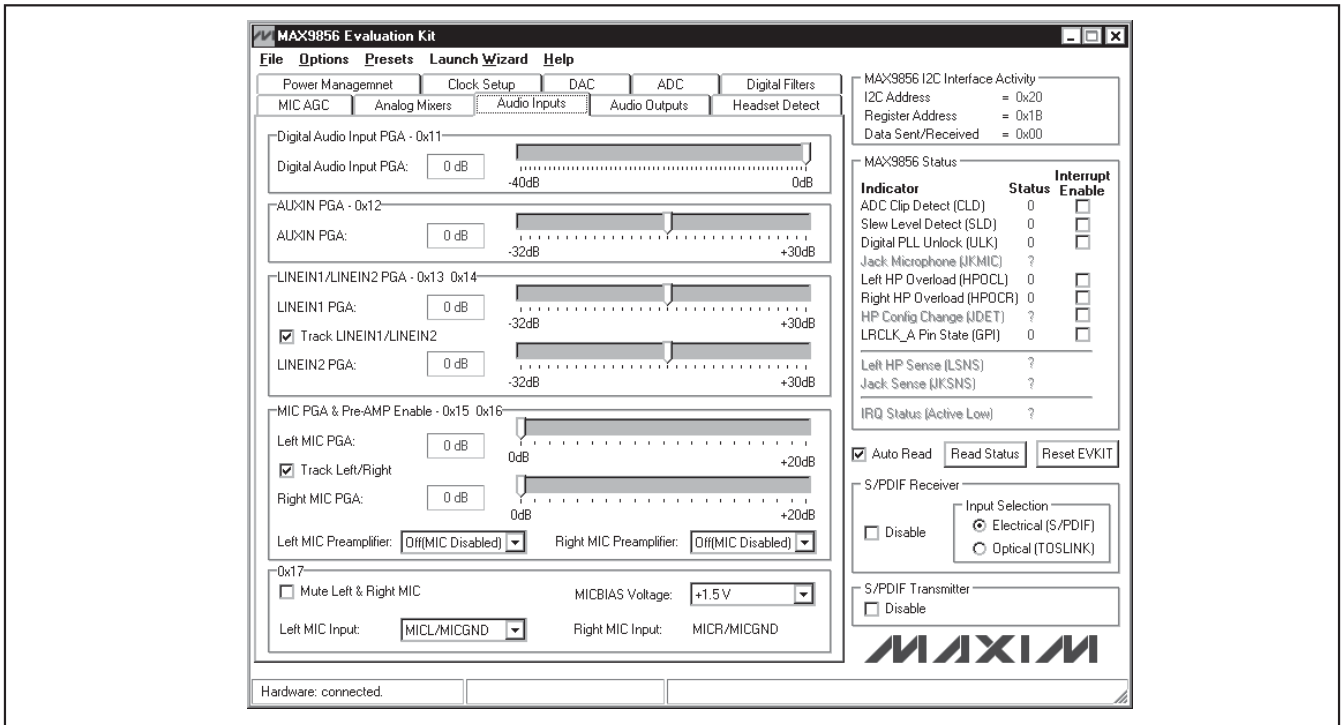

Figure 16. MAX9856 Evaluation Software (Audio Inputs Tab)



# MAX9856 Evaluation Kit

## Audio Outputs Tab

On the **Audio Outputs** tab (Figure 17), the **Line Output Enable** checkbox can enable or disable the line output.

The headphone can be muted by checking the **Mute Headphone** checkbox. The gain of the headphones can be set from -73.5dB to +6dB by moving the left or the right headphone volume track bars.

Check the **Volume Slewing Enable** checkbox to give a smooth sounding gain change. Check **AUXIN DC Measurement Enable** to directly connect the AUXIN to ADC input for DC measurement (JU5 must be closed). The AUXIN signal can be directly mixed into the headphone amplifiers by checking the **Mix AUXIN Directly into the Headphone** checkbox.

The headphone output mode can be set by selecting the **Headphone Output Mode** drop-down list.

## Headset Detect Tab

The **Headset Detect** tab (Figure 18) demonstrates how a headset insertion or removal can be detected. The state of popular headset jack pins can be measured to configure the headset properly.

Check **Enable Detect (0x1B, JDETEN)** to activate the headset-detection circuitry. The detection result is reported in the **Headset Presence** group box.

If the **Auto Read** checkbox is checked, the software automatically monitors the insertion and removal of a headset and reports the result in the **Headset Presence** group box. If there is a headset configuration change, the software automatically detects the headset impedance and reports the result in the **Headset Impedance** group box.

## Troubleshooting

The MAX9856 software automatically searches for all of the on-board I<sup>2</sup>C devices. Any missing I<sup>2</sup>C device is reported in a message window (Figure 19).

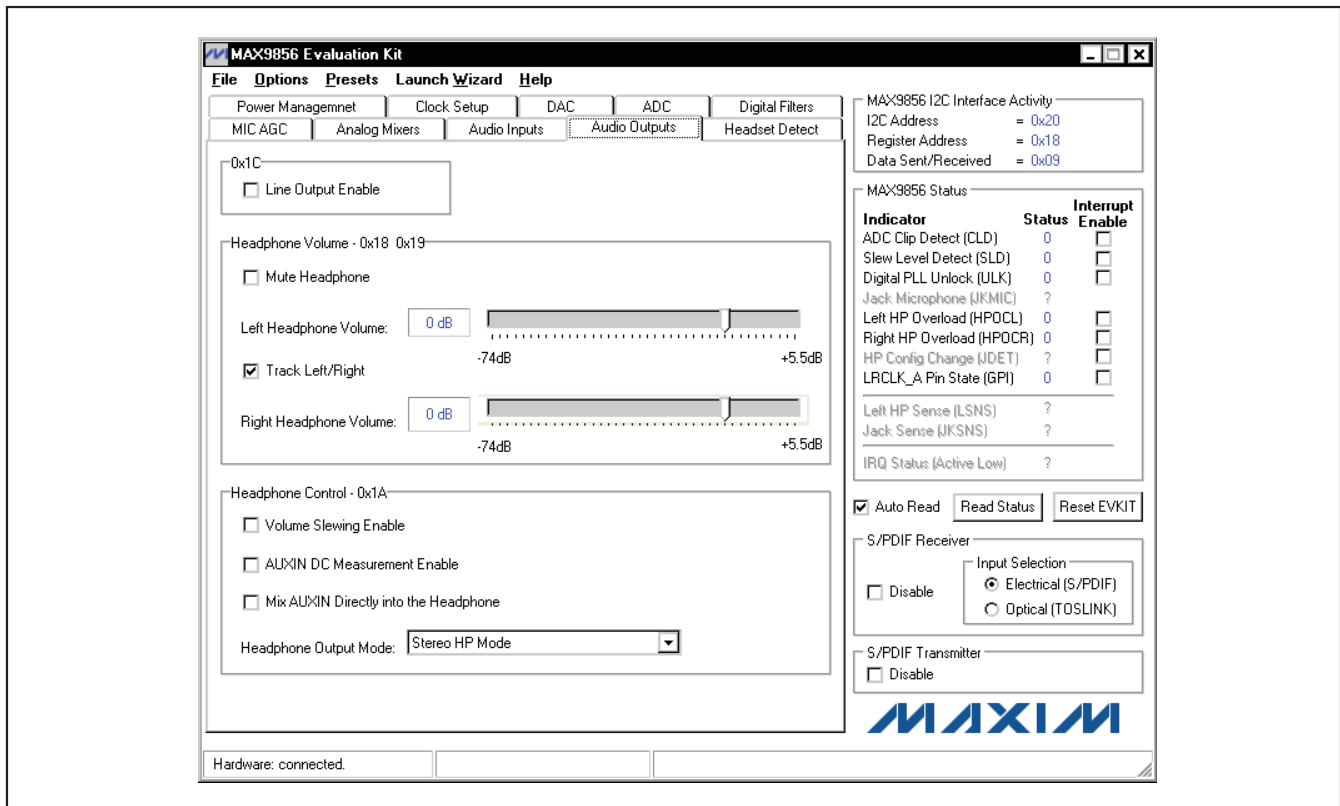

Figure 17. MAX9856 Evaluation Software (Audio Outputs Tab)

# MAX9856 Evaluation Kit

Evaluates: MAX9856

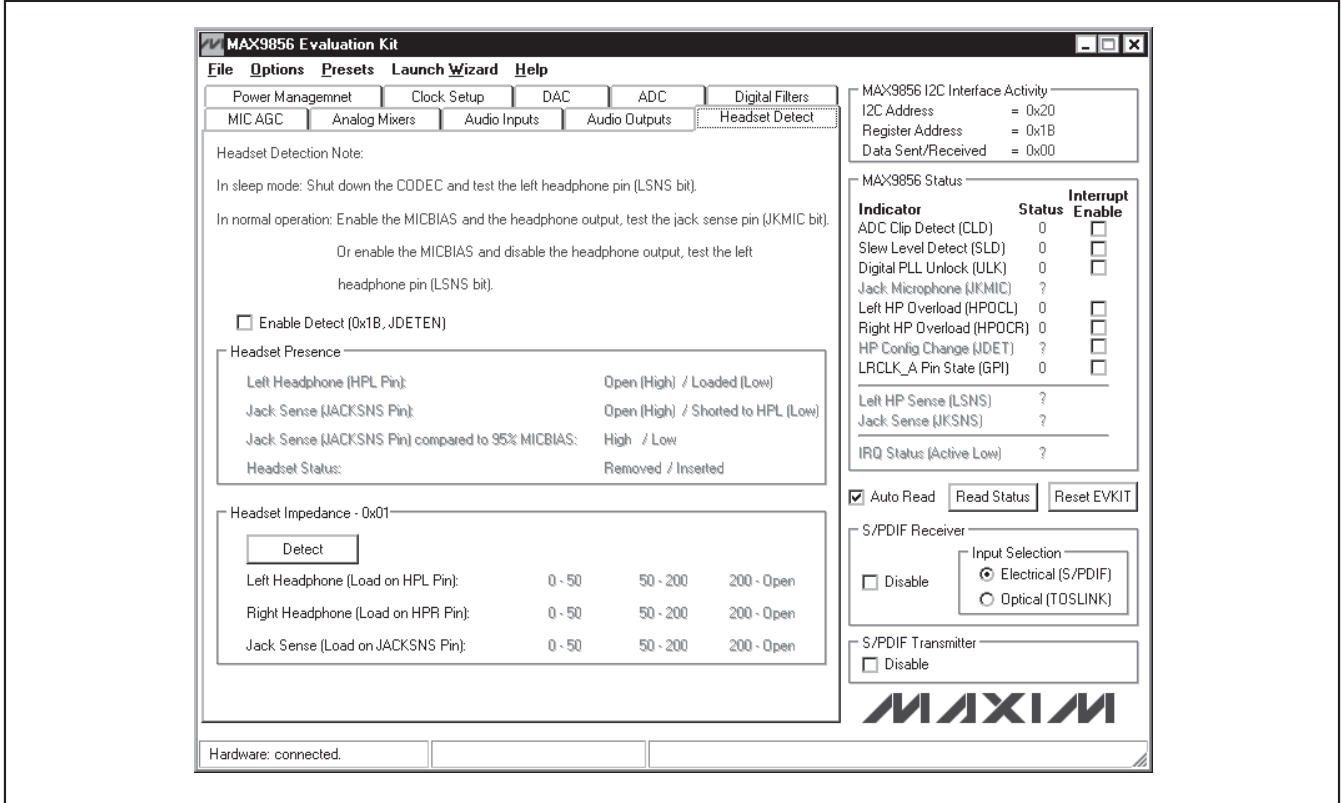

Figure 18. MAX9856 Evaluation Software (Headset Detect Tab)

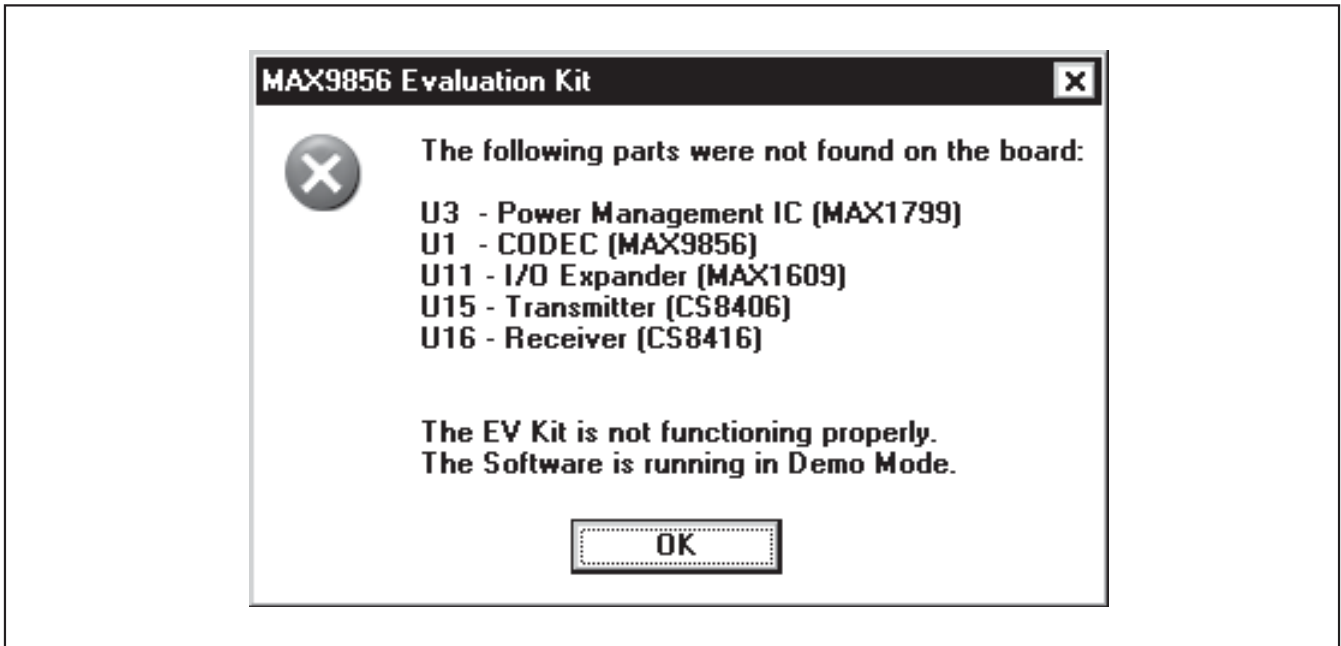

Figure 19. MAX9856 Evaluation Software (Missing I2C Device Message)

# MAX9856 Evaluation Kit

## Detailed Description of Hardware

The MAX9856 EV kit is a complete digital audio evaluation system for the MAX9856 audio CODEC. The portion of the EV kit required to operate the MAX9856 is shown in Figure 20. All additional components are included to aid evaluations.

In addition to providing access to all MAX9856 audio inputs and outputs, the EV kit provides translation of the on-board serial digital audio signals to coaxial S/PDIF

signals to allow for easy connection with consumer electronics devices.

Access the S/PDIF inputs through the RCA connector at J12. Access the S/PDIF outputs through the RCA connector at J11. All S/PDIF connections function for sample rates from 32kHz to 96kHz. To transmit lower sample rates, connect a serial audio transmitter or receiver directly to the MAX9856.

To connect the EV kit using optical cables, install TOSLINK connectors on J13 and J14.

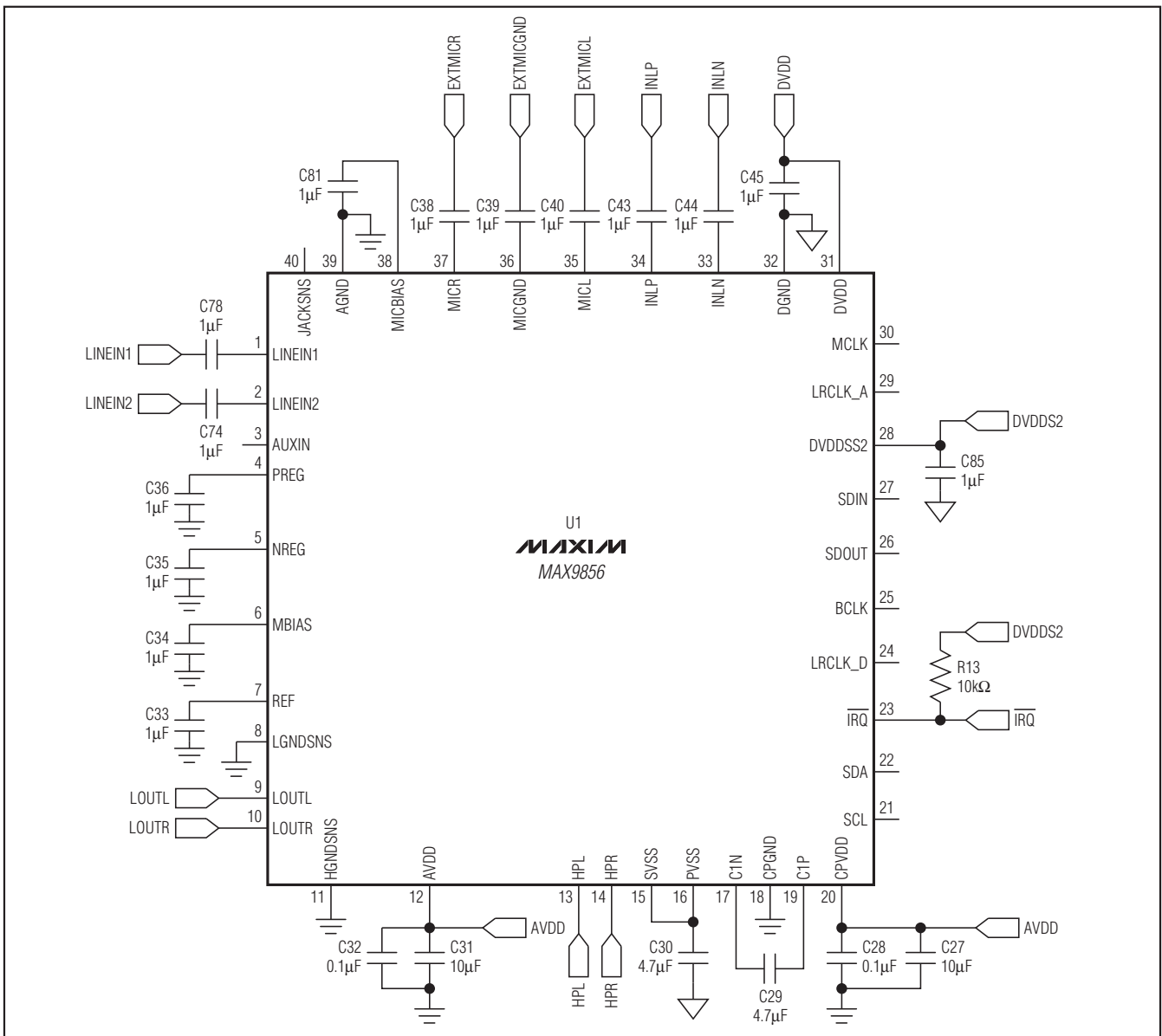

Figure 20. Minimum Required EV Kit Components

# MAX9856 Evaluation Kit

Evaluates: MAX9856

**Table 2. EV Kit Jumper Settings**

JUMPER	SHUNT POSITION	DESCRIPTION
JU1	1-2* (all rows)	On-board I <sup>2</sup> S interface and I <sup>2</sup> C interface
	Open (all rows)	External I <sup>2</sup> S interface and I <sup>2</sup> C interface
JU2	2-3*	LRCLK_A used as GPIO
	1-2	LRCLK_A used as ADC LRCLK
JU4	Connected*	JACKSNS pin connected to the headphone jack pin 4
	Open	JACKSNS pin has no connection
JU5	Connected*	DC-coupled AUXIN
	Open	AC-coupled AUXIN
JU6, JU7	Connected*	Internal microphone biased by MICBIAS
	Open	No bias applied on internal microphone inputs
JU8	Connected*	DVDD connected to the MAX1799 OUT2 DVDD ranges from 1.8V to 3.3V
	Open	External DVDD can be applied on the DVDD pad
JU9	Connected*	AVDD connected to the MAX1799 OUT3 AVDD ranges from 1.8V to 3.3V
	Open	External AVDD can be applied on the DVDD pad
JU10	Connected*	DVDDS2 connected to the MAX1799 OUT1 DVDDS2 is fixed at 3.3V
	Open	External DVDDS2 can be applied on the DVDDS2 pad

\*Default position.

Access the analog line inputs through RCA connectors at J6 and J7. Access the analog line outputs through RCA connectors at J4 and J5.

Connect headphones to the DirectDrive headphone output of the MAX9856 through the 3.5mm headphone jack (J3). Connect external microphones through the 3.5mm microphone jack (J8).

The remaining inputs and outputs of the MAX9856 are accessible through pads on the right and bottom sides of the EV kit.

See Table 2 for a description of all EV kit jumper configurations.

### Power Management

The USB host supplies 5V power to the MAX1799. When the EV kit is connected to a PC, the MAX1799 generates a 3V output on the OUT1 pin so that all the I<sup>2</sup>C interfaces on the board are working. After the software is running, the DVDD and AVDD can be configured to power the MAX9856.

See Table 3 for a listing of each EV kit supply.

**Table 3. EV Kit Power Supplies**

EV KIT SUPPLY	DESCRIPTION
MAX1799 PMIC	Input: VUSB from USB host Output: VMOD, VVCO, DVDD, AVDD
VMOD, VVCO	3.3V supply that powers every IC except the MAX9856
DVDD	1.8V to 3.3V supply that powers DVDD on the MAX9856
AVDD	1.8V to 3.3V supply that powers AVDD and CPVDD on the MAX9856
DVDDS2	Digital audio interface I/O power supply for the MAX9856

# MAX9856 Evaluation Kit

## Differential (Internal) Microphone Connection

R22 and R44 provide microphone bias connections for the internal differential microphone input. Remove the shunts on JU6 and JU7 to remove the microphone bias.

## Stereo (External) Microphone Connection

R16 and R17 provide external left and right microphone bias. Use the EXTMICGND pin for the ground connection of all microphones connected to this interface.

## Control and Data Interface

JU1 connects the MAX9856 digital I/O pins to the rest of the EV kit. For normal operation, install a shunt across pins 1-2 of each row of JU1 (Figure 21). Remove shunts as necessary to connect equipment or other components directly to the MAX9856. Pin 3 of each row provides a clean connection to the digital ground plane of the EV kit for grounding test leads. Pin 3 of each row provides a clean connection to the digital ground plane of the EV kit for grounding test leads. Place a shunt between pin 2 of SDIN and pin 2 of SDOUT to place the digital audio interface in loopback mode. This process routes data from the ADC directly back into the DAC for testing purposes.

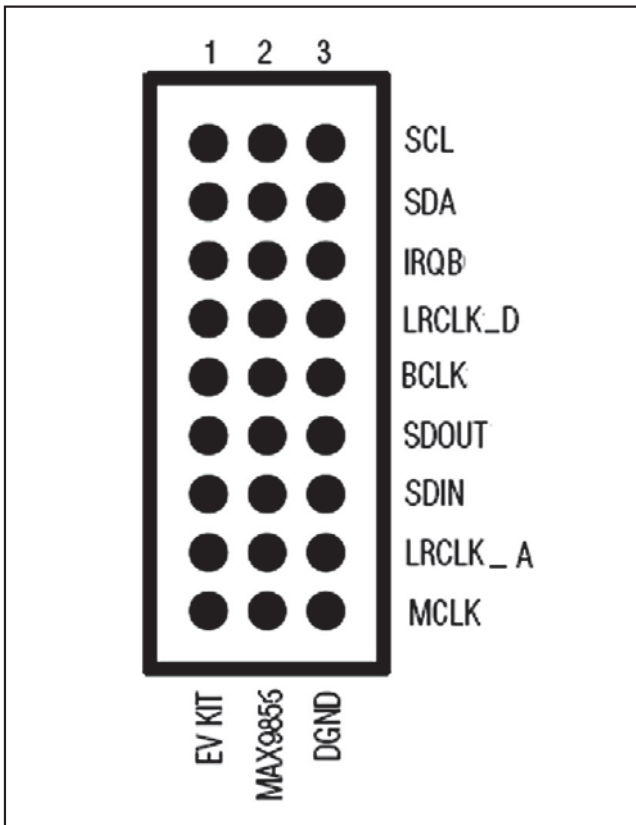

Figure 21. Header JU1

## Clocking

### On-Board Clock

The MAX9856 EV kit features an on-board 12MHz crystal clock oscillator to provide the necessary master clock for the MAX9856.

### Recovered Clock

When S/PDIF IN has digital audio input and the S/PDIF receiver is in operation, the recovered clock from the S/PDIF receiver can be used as the master clock for the MAX9856.

### External Clocks

Connect an external clock source to the SMA connector (J10) to drive the MAX9856's MCLK pin without using the on-board oscillator. When using an external clock, the **User Provided Clock (10MHz – 60MHz)** option must be selected on the **Clock Setup** tab (Figure 10). The user must type in the correct clock frequency in the **Frequency** edit box. Populate R21 and C49 as appropriate to provide termination for the incoming signal.

### Using an Alternative I<sup>2</sup>C Interface

Connect an I<sup>2</sup>C master to the SDA and SCL pads of the MAX9856 EV kit to communicate with the I<sup>2</sup>C parts without using the on-board I<sup>2</sup>C signals generated by the microcontroller (U2).

See Table 4 to determine the I<sup>2</sup>C address of each device on the EV kit. All I<sup>2</sup>C addresses are fixed in hardware.

Table 4. I<sup>2</sup>C Addresses

DEVICE	I <sup>2</sup> C ADDRESS
MAX9856 (U1)	0010 000
MAX1799 (U3)	0111 111
MAX1609 (U11)	0100 100
CS8406 (U15)	0010 011
CS8416 (U16)	0010 100

# MAX9856 Evaluation Kit

Evaluates: MAX9856

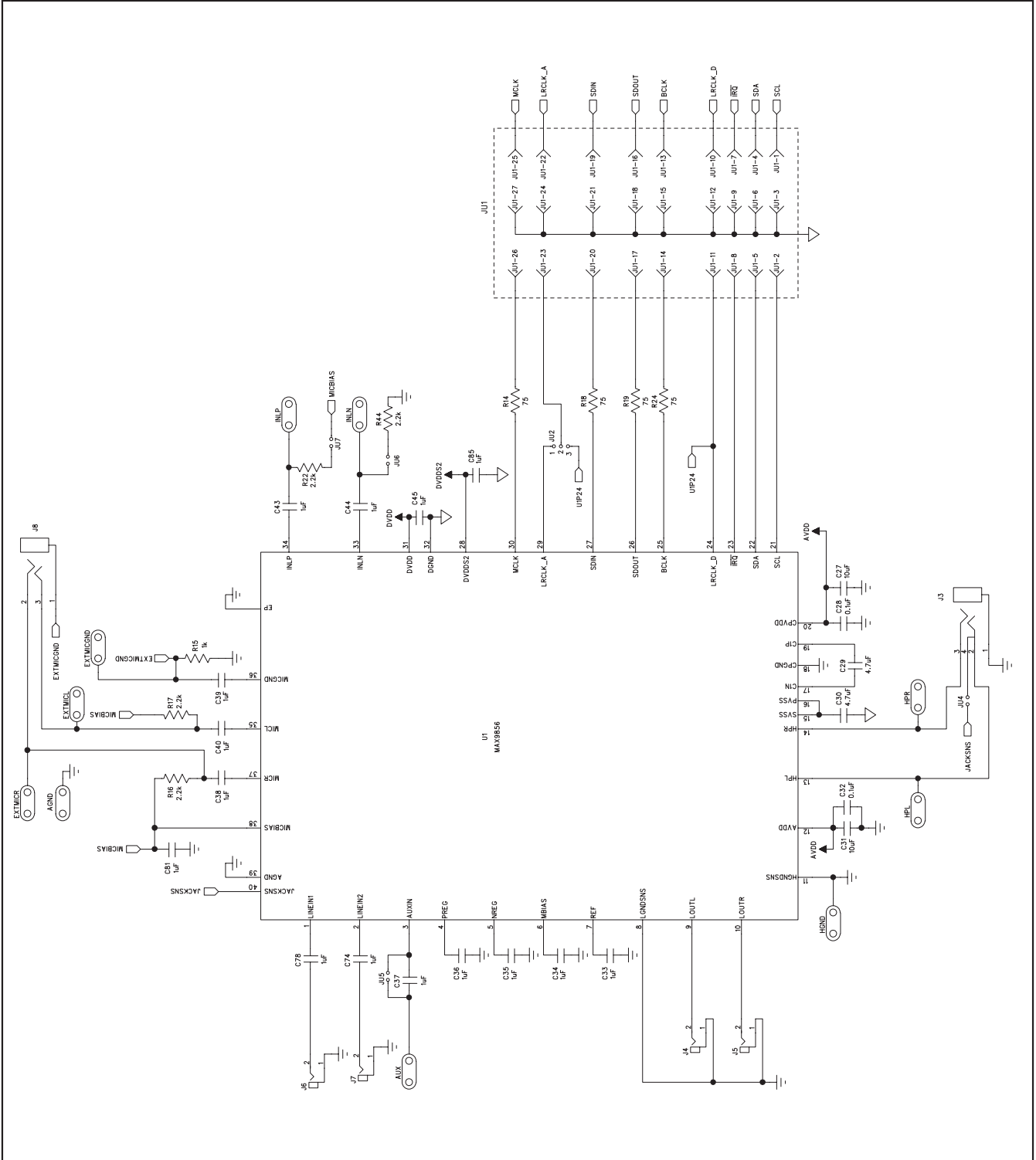

Figure 22a. MAX9856 EV Kit Schematic (Sheet 1 of 6)





# MAX9856 Evaluation Kit

Evaluates: **MAX9856**

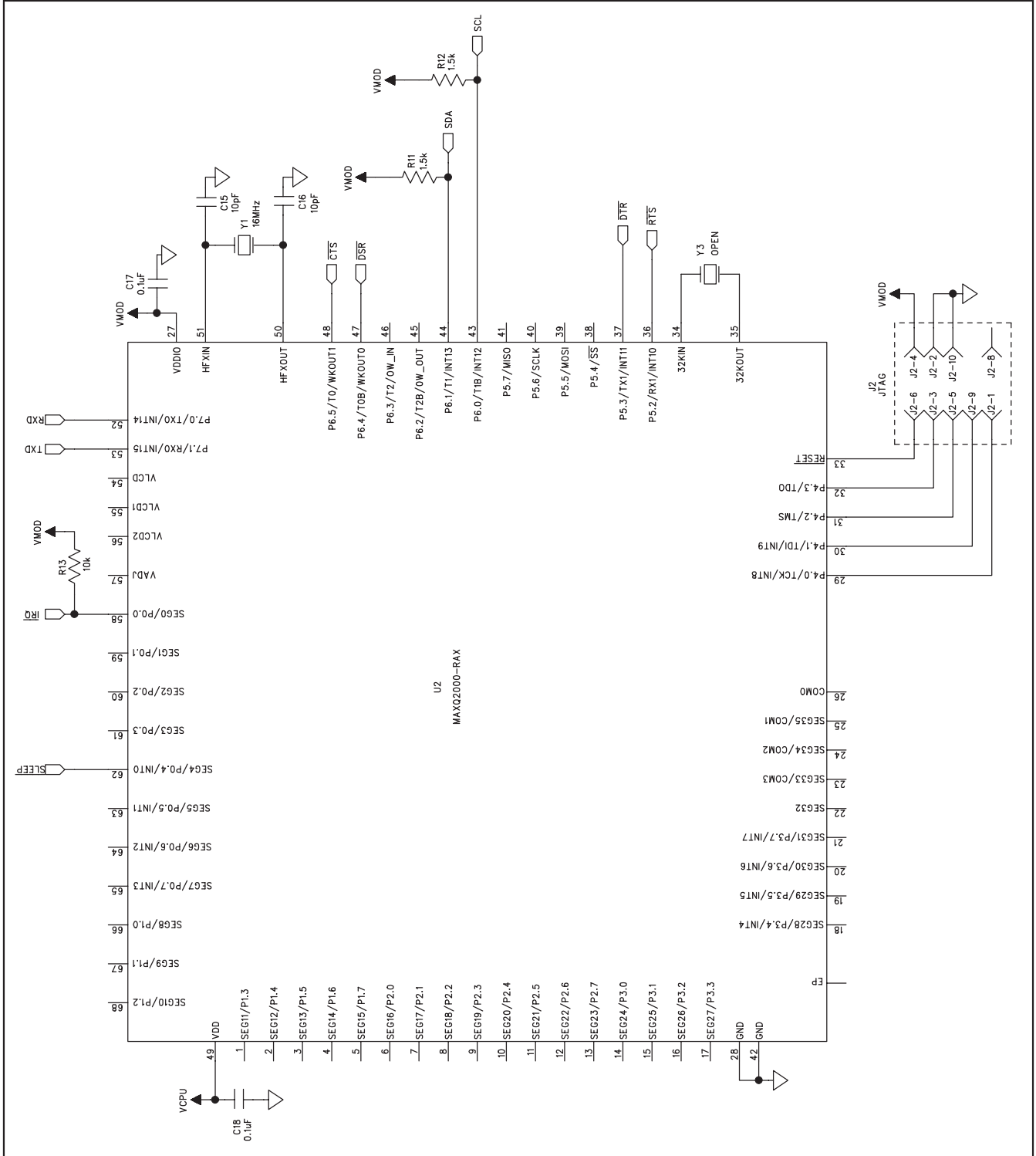

Figure 22c. MAX9856 EV Kit Schematic (Sheet 3 of 6)

# MAX9856 Evaluation Kit

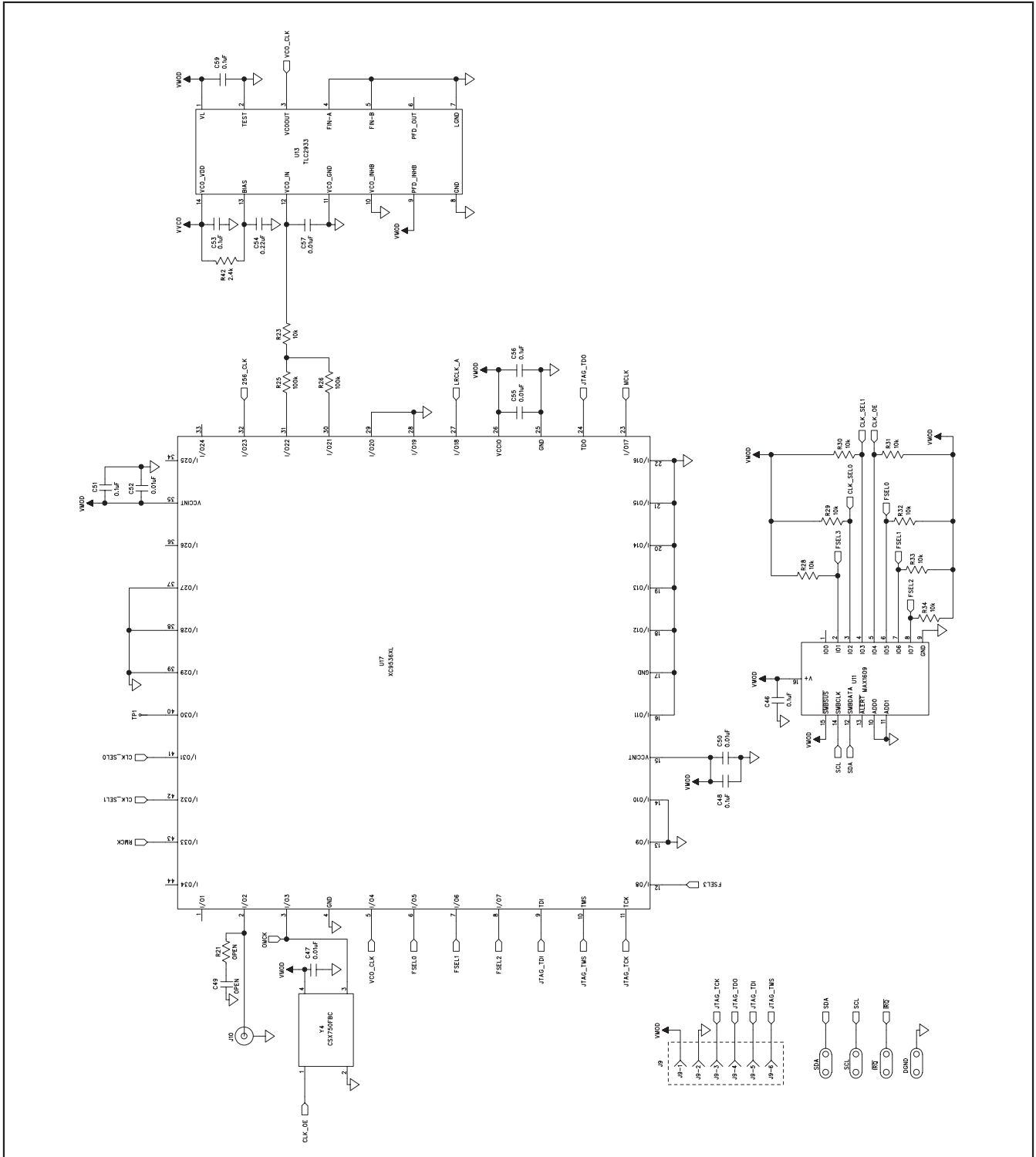

Figure 22d. MAX9856 EV Kit Schematic (Sheet 4 of 6)

# MAX9856 Evaluation Kit

Evaluates: MAX9856

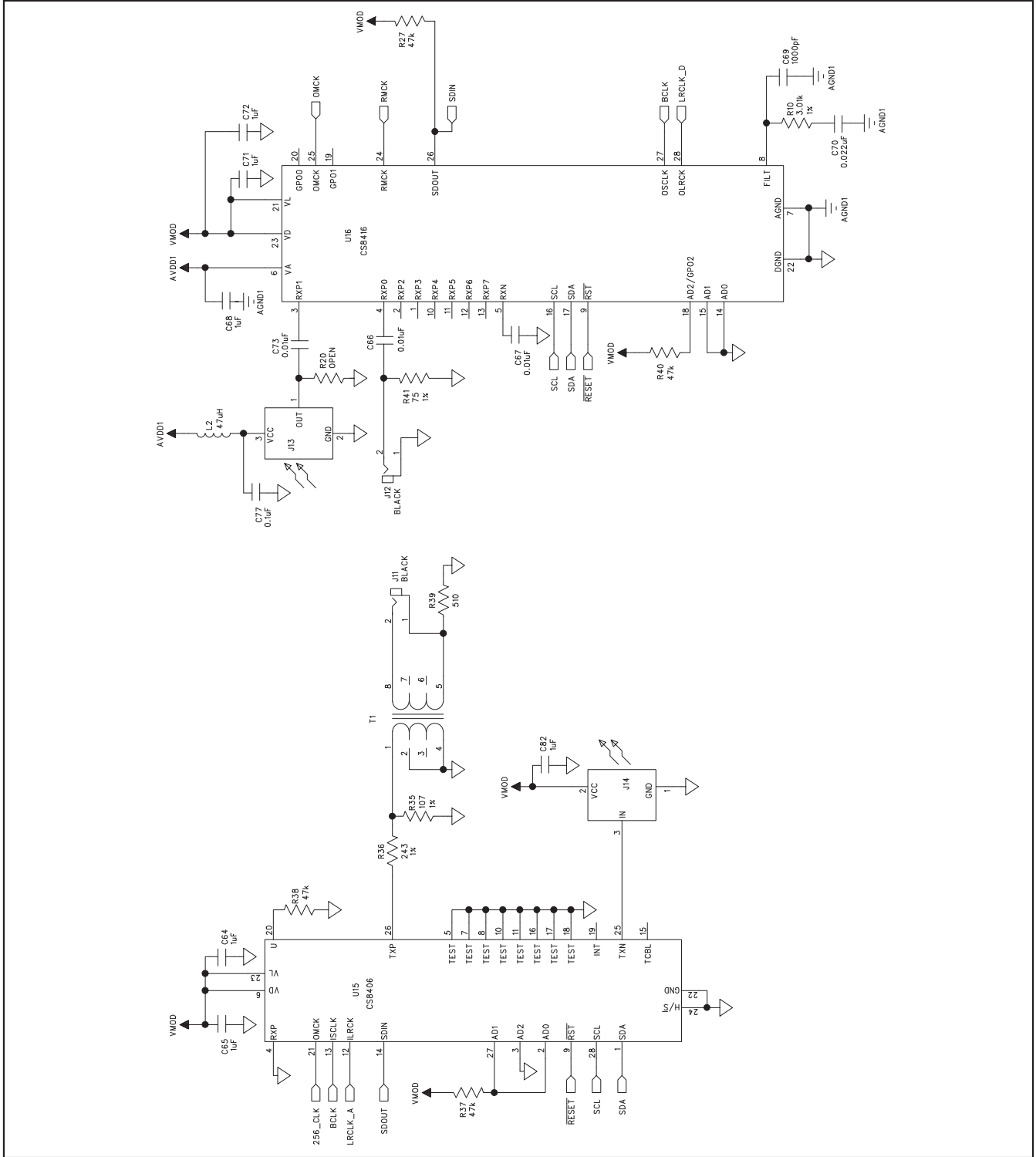

Figure 22e. MAX9856 EV Kit Schematic (Sheet 5 of 6)

# MAX9856 Evaluation Kit

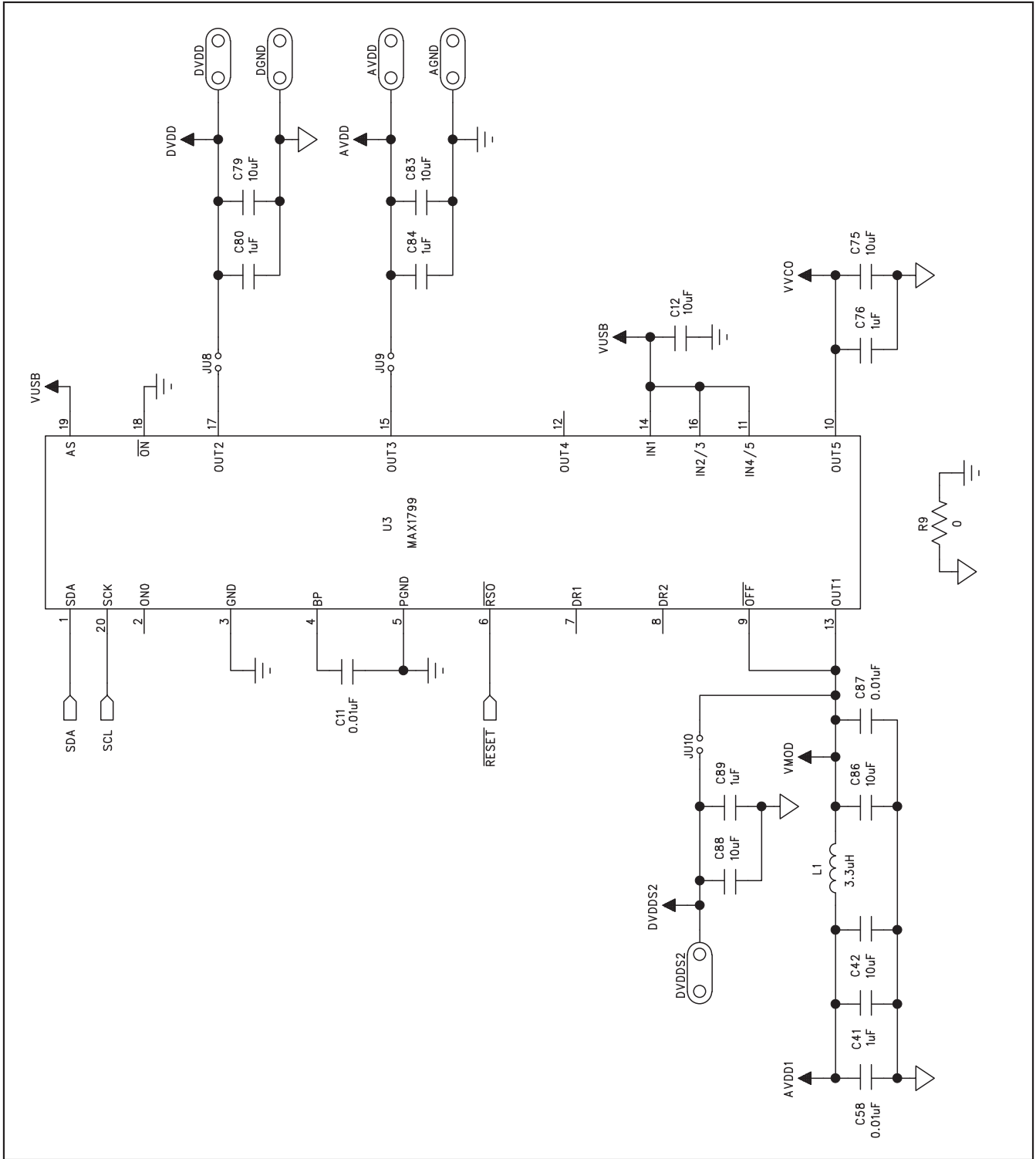
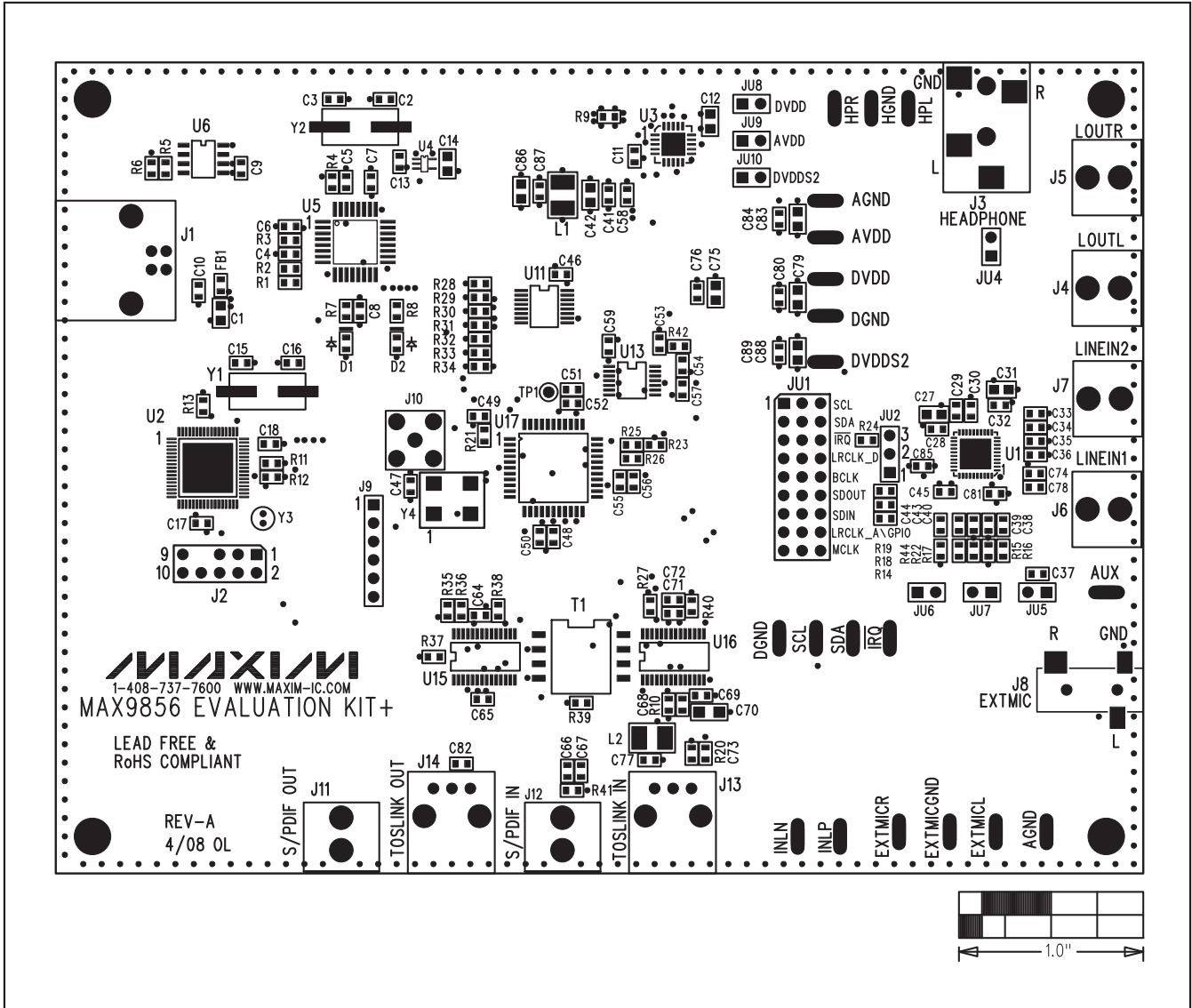

Figure 22f. MAX9856 EV Kit Schematic (Sheet 6 of 6)

# MAX9856 Evaluation Kit

Evaluates: MAX9856



# MAX9856 Evaluation Kit

Evaluates: MAX9856

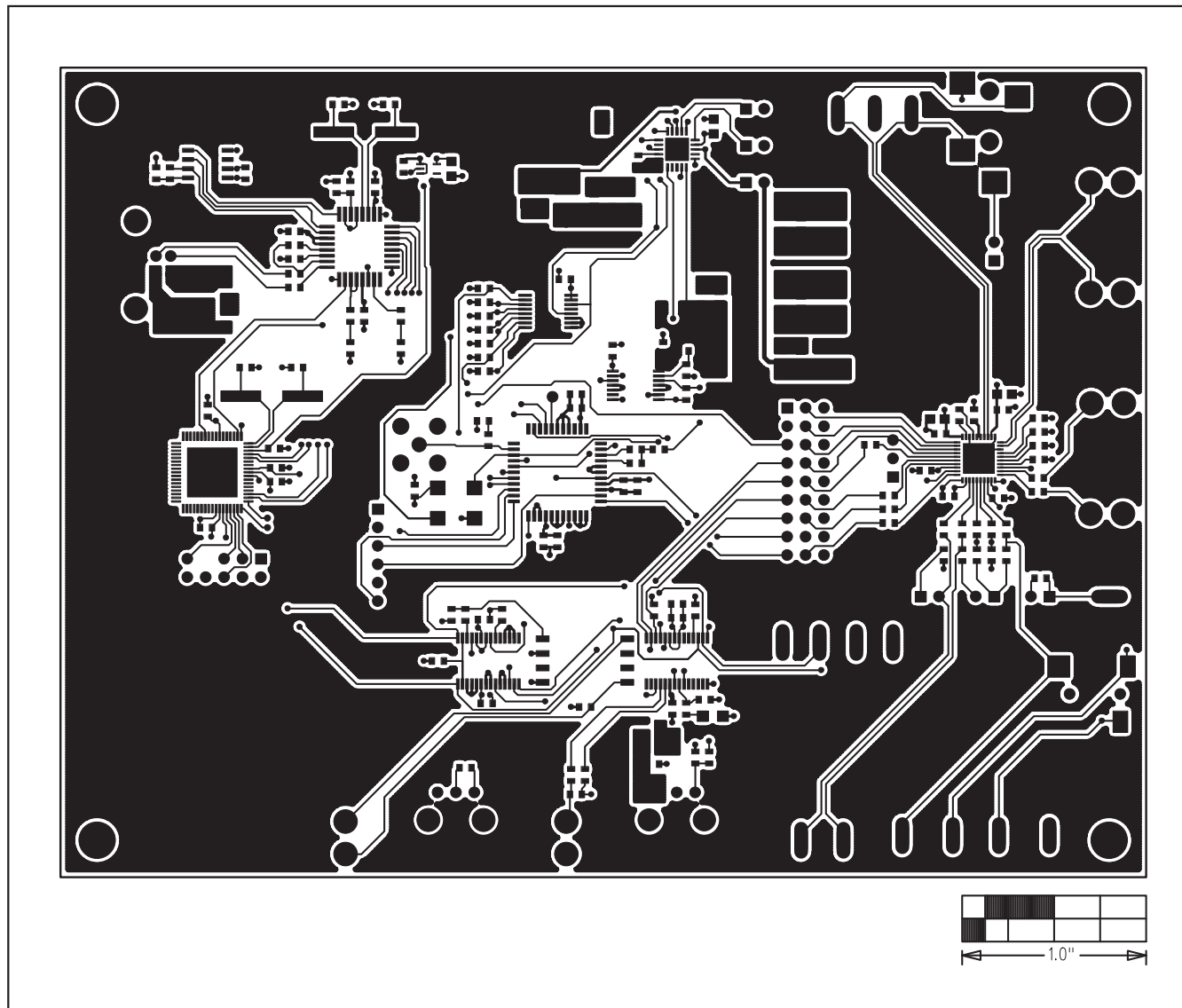

Figure 24. MAX9856 EV Kit PCB Layout—Component Side

# MAX9856 Evaluation Kit

Evaluates: MAX9856

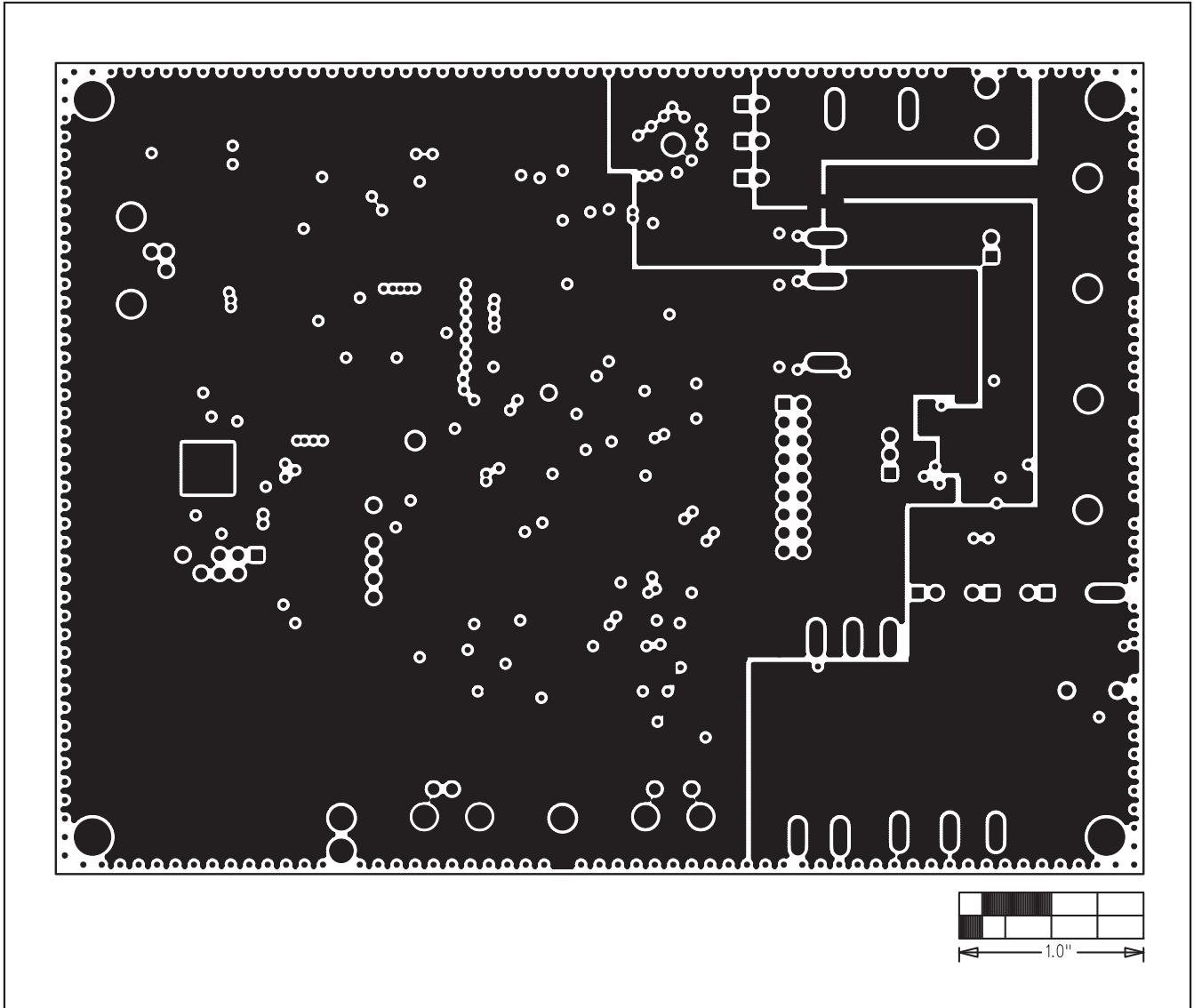

Figure 25. MAX9856 EV Kit PCB Layout—Inner Layer 2



# MAX9856 Evaluation Kit

Evaluates: MAX9856

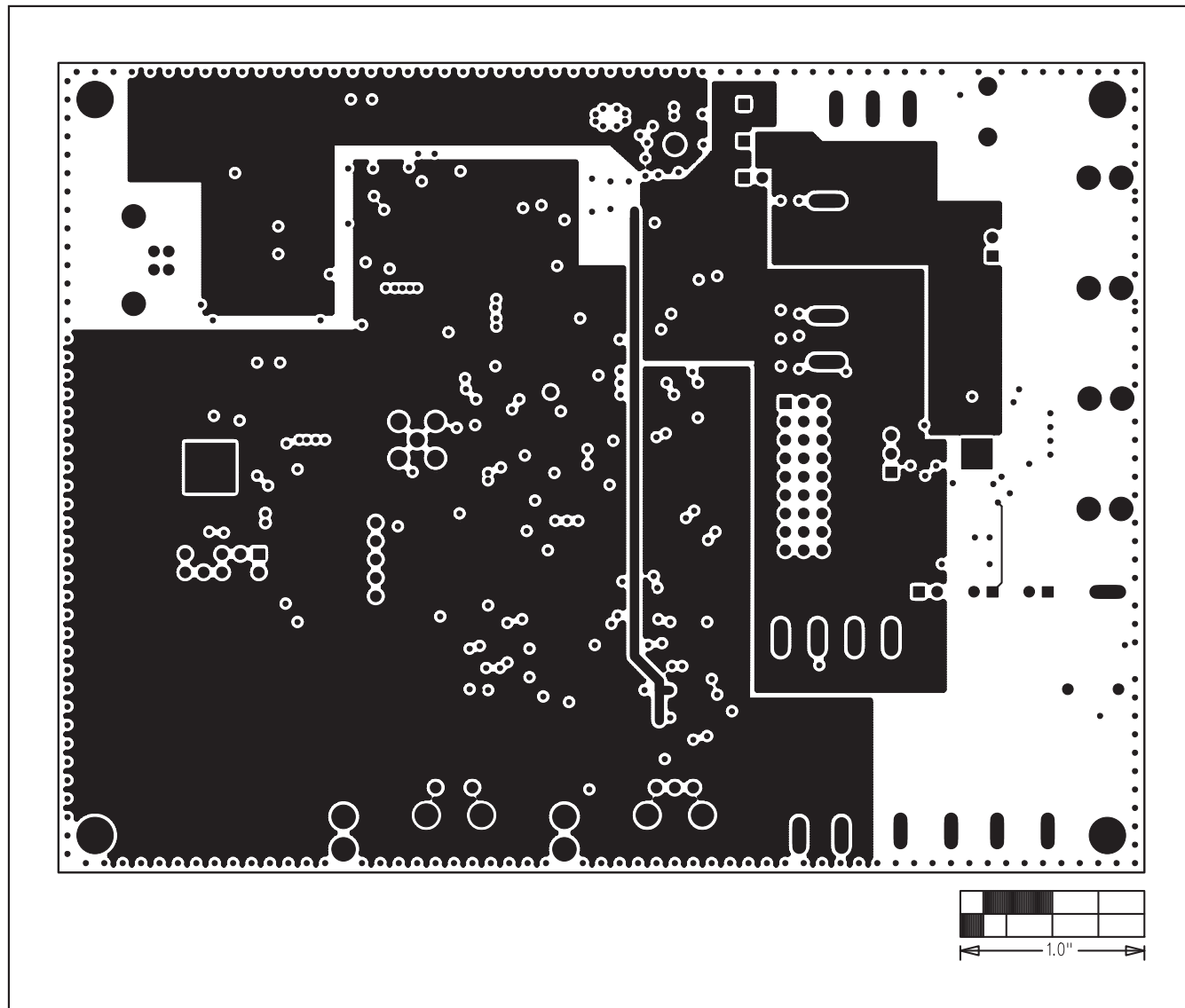

Figure 26. MAX9856 EV Kit PCB Layout—Inner Layer 3

# MAX9856 Evaluation Kit

Evaluates: **MAX9856**

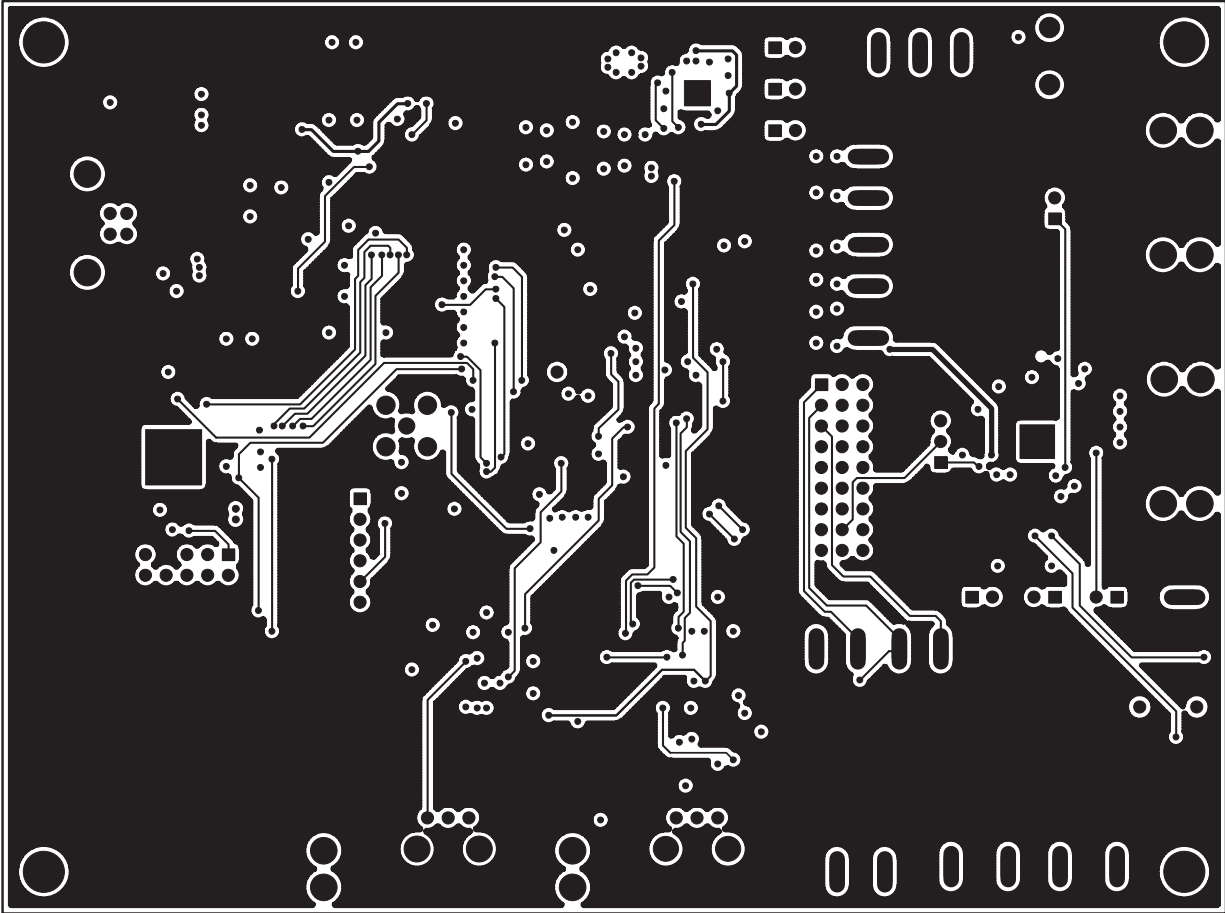

Figure 27. MAX9856 EV Kit PCB Layout—Solder Side

# **MAX9856 Evaluation Kit**

## **Revision History**

<b>REVISION NUMBER</b>	<b>REVISION DATE</b>	<b>DESCRIPTION</b>	<b>PAGES CHANGED</b>
0	6/08	Initial release	—
1	3/10	Replaced Figure 17	16

*Maxim cannot assume responsibility for use of any circuitry other than circuitry entirely embodied in a Maxim product. No circuit patent licenses are implied. Maxim reserves the right to change the circuitry and specifications without notice at any time.*

**32** \_\_\_\_\_ **Maxim Integrated Products, 120 San Gabriel Drive, Sunnyvale, CA 94086 408-737-7600**