

Three ADCs, One DAC, Low Power Codec with Audio DSPs

FEATURES

- ▶ Programmable FastDSP audio processing engine
 - ▶ Up to 768 kHz sample rate
 - ▶ Biquad filters, limiters, volume controls, mixing
- ▶ Tensilica HiFi 3z DSP core
 - ▶ Quad MAC per cycle: 24 x 24-bit multiplier and 64-bit accumulator
 - ▶ Flexible power operation mode: 24.576 MHz, 49.152 MHz, 73.728 MHz, and 98.304 MHz
 - ▶ 336 kB total memory
 - ▶ JTAG debug and trace
- ▶ Low latency, 24-bit ADCs and DAC
 - ▶ 106 dB SNR (signal through ADC with A-weighted filter)
 - ▶ 110 dB combined SNR (signal through DAC and headphone with A-weighted filter)
- ▶ Programmable double precision MAC engine for maximum 24-stage equalizer
- ▶ Serial port sample rates from 8 kHz to 768 kHz
- ▶ 5 μ s group delay ($f_s = 768$ kHz) analog in to analog out with FastDSP bypass (zero instructions)
- ▶ 3 differential or single-ended analog inputs, configurable as microphone or line inputs
- ▶ 8 digital microphone inputs
- ▶ Analog differential audio output, configurable as either line output or headphone drive
- ▶ 2 PDM output channels
- ▶ PLL supporting any input clock rate from 30 kHz to 36 MHz
- ▶ 4 channel asynchronous sample rate converters (ASRCs)
- ▶ 2, 16-channel serial audio ports supporting I²S, left justified, right justified, or up to TDM16 (TDM12 in Turbo mode)
- ▶ 8 interpolators and 8 decimators with flexible routing
- ▶ Power supplies

- ▶ Digital I/O IOVDD at 1.1 V to 1.98 V
- ▶ Digital DVDD at 0.85 V to 1.21 V
- ▶ Headphone HPVDD at 1.8 V typical
- ▶ Headphone HPVDD_L at 1.2 V to HPVDD
- ▶ Control/communication interfaces
 - ▶ I²C, SPI, or UART control ports
 - ▶ Master quad SPI (QSPI)
 - ▶ UART communication port
- ▶ Self-boot from QSPI flash
- ▶ Flexible GPIO and IRQ
- ▶ 56-ball, 0.35 mm pitch, 2.980 mm × 2.679 mm WLCSP

APPLICATIONS

- ▶ Noise canceling handsets, headsets, and headphones
- ▶ Bluetooth active noise canceling (ANC) handsets, headsets, and headphones
- ▶ Personal navigation devices
- ▶ Digital still and video cameras
- ▶ Musical instrument effect processors
- ▶ Multimedia speaker systems
- ▶ Smartphones

GENERAL DESCRIPTION

The ADAU1860 is a codec with three inputs and one output that incorporates two digital signal processors (DSPs). The path from the analog input to the DSP core to the analog output is optimized for low latency and is ideal for noise canceling earphone. With the addition of just a few passive components, the ADAU1860 provides a complete earphone solution.

Analog Devices is in the process of updating documentation to provide terminology and language that is culturally appropriate. This is a process with a wide scope and will be phased in as quickly as possible. Thank you for your patience.

TABLE OF CONTENTS

Features.....	1	Thermal Resistance.....	16
Applications.....	1	Electrostatic Discharge (ESD) Ratings.....	16
General Description.....	1	ESD Caution.....	16
Functional Block Diagram.....	3	Pin Configuration and Function Descriptions.....	17
Specifications.....	4	Typical Performance Characteristics.....	20
Analog Performance Specifications.....	4	Theory of Operation.....	27
Crystal Amplifier Specifications.....	8	System Block Diagram.....	28
Digital Input and Output Specifications.....	9	Applications Information.....	29
Power Supply Specifications.....	9	Power Supply Bypass Capacitors.....	29
Power-Down Current.....	9	Layout.....	29
Typical Power Consumption.....	10	Grounding.....	29
Digital Filters.....	11	Outline Dimensions.....	30
Digital Timing Specifications.....	11	Ordering Guide.....	30
Absolute Maximum Ratings.....	16	Evaluation Boards.....	30

REVISION HISTORY**9/2022—Rev. 0 to Rev. A**

Changes to Features Section.....	1
Changes to Table 1.....	4
Changes to Typical Performance Characteristics Section.....	20
Changes to Theory of Operation Section.....	27

10/2021—Revision 0: Initial Version

FUNCTIONAL BLOCK DIAGRAM

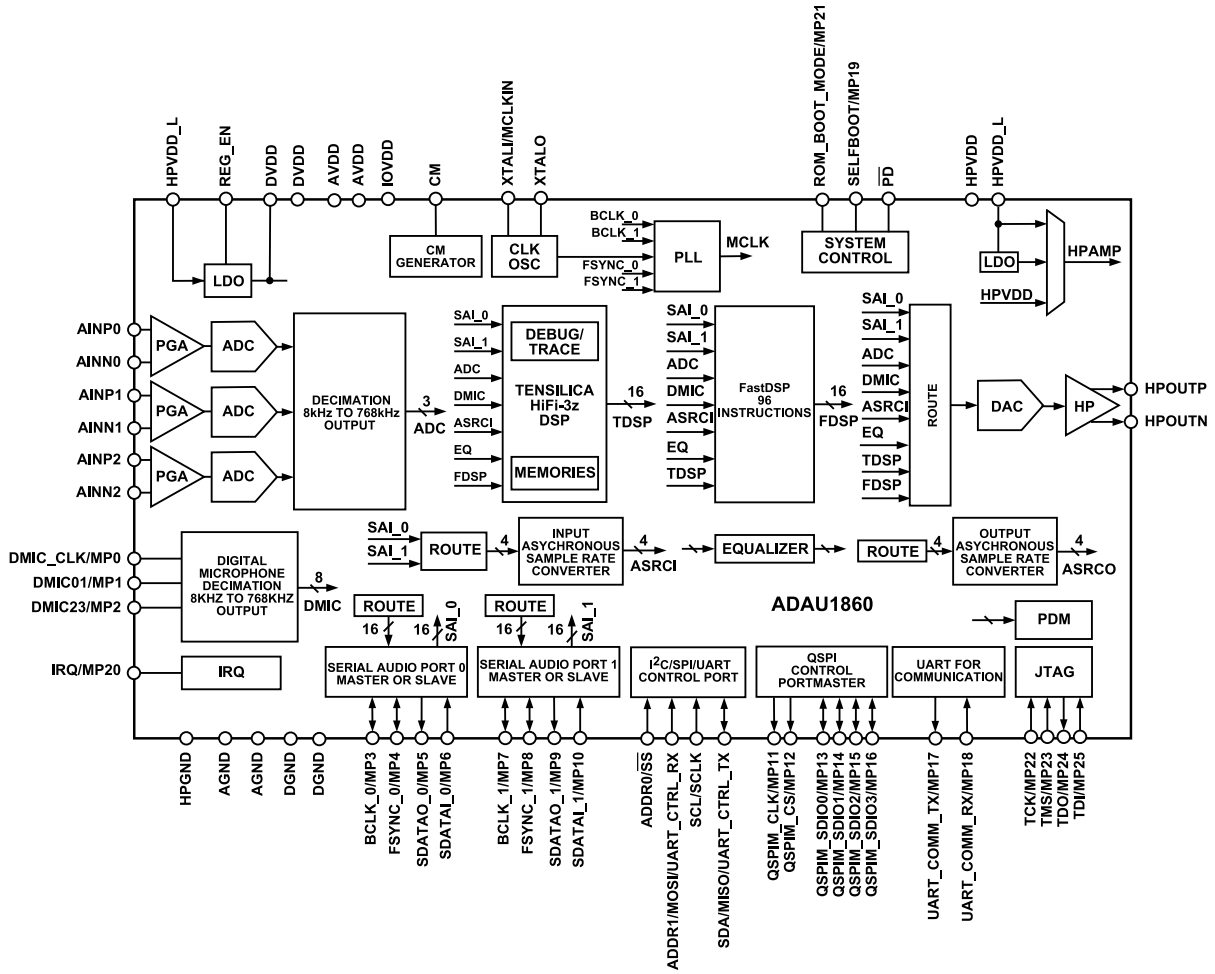

Figure 1.

001

SPECIFICATIONS

Master clock = 24.576 MHz, Hibernate 1 mode, serial input sample rate = 48 kHz, measurement bandwidth = 20 Hz to 20 kHz, word width = 24 bits, ambient temperature = 25°C, and outputs line loaded with 10 k Ω , unless otherwise noted.

ANALOG PERFORMANCE SPECIFICATIONS

Supply voltages: AVDD = HPVDD = IOVDD = 1.8 V, and DVDD = 0.9 V, unless otherwise noted.

Table 1.

Parameter	Test Conditions/Comments	Min	Typ	Max	Unit
ANALOG-TO-DIGITAL CONVERTERS (ADCs)					
ADC Resolution	All ADCs		24		Bits
Digital Gain Step			0.375		dB
Digital Gain Range		-71.25		+24	dB
INPUT RESISTANCE (R_{IN})					
Single-Ended Line Input	Nonvoice wake-up mode		9		k Ω
	Voice wake-up mode		18		k Ω
Differential Line Input	Nonvoice wake-up mode		36		k Ω
	Voice wake-up mode		36		k Ω
Programmable Gain Amplifier (PGA) Single-Ended Inputs	PGA high R _{IN} , normal, 0 dB gain		20.6		k Ω
	PGA high R _{IN} , normal, 24 dB gain		2.4		k Ω
	PGA low R _{IN} , enhanced, 0 dB gain		10.3		k Ω
	PGA low R _{IN} , enhanced, 24 dB gain		1.2		k Ω
	PGA high R _{IN} , enhanced, 0 dB gain		20.6		k Ω
	PGA high R _{IN} , enhanced, 24 dB gain		2.4		k Ω
	PGA Differential Inputs	PGA high R _{IN} , normal, 0 dB gain		41.2	
	PGA high R _{IN} , normal, 24 dB gain		4.8		k Ω
	PGA low R _{IN} , enhanced, 0 dB gain		20.6		k Ω
	PGA low R _{IN} , enhanced, 24 dB gain		2.4		k Ω
	PGA high R _{IN} , enhanced, 0 dB gain		41.2		k Ω
	PGA high R _{IN} , enhanced, 24 dB gain		4.8		k Ω
SINGLE-ENDED LINE INPUT					
Full-Scale Input Voltage	0 dBFS		0.49		V rms
	0 dBFS		1.39		V p-p
Dynamic Range ¹ With A-Weighted Filter (RMS)	20 Hz to 20 kHz, -60 dB input				
	Enhanced performance		103		dB
	Normal performance		103		dB
	Power saving		102		dB
With Flat 20 Hz to 20 kHz Filter	Voice wake up		99		dB
	Enhanced performance		98		dB
	Normal performance		98		dB
	Power saving		98		dB
Signal-to-Noise Ratio (SNR) ² With A-Weighted Filter (RMS)	Voice wake up		96		dB
	Enhanced performance		102		dB
	Normal performance		102		dB
	Power saving		102		dB
With Flat 20 Hz to 20 kHz Filter	Voice wake up		98		dB
	Enhanced performance		98		dB
	Normal performance		98		dB
	Power saving		98		dB
	Voice wake up		95		dB

SPECIFICATIONS

Table 1.

Parameter	Test Conditions/Comments	Min	Typ	Max	Unit
Interchannel Gain Mismatch			40		mdB
Total Harmonic Distortion + Noise (THD + N)	20 Hz to 20 kHz, -1 dB full-scale output				
	Enhanced performance		-78		dBFS
	Normal performance		-78		dBFS
	Power saving		-78		dBFS
	Voice wake up		-78		dBFS
Offset Error			±0.3		mV
Gain Error			±0.2		dB
Interchannel Isolation	CM capacitor = 1 µF		100		dB
Power Supply Rejection Ratio (PSRR)	CM capacitor = 1 µF				
	100 mV p-p at 1 kHz		60		dB
	100 mV p-p at 10 kHz		40		dB
DIFFERENTIAL LINE INPUT					
Full-Scale Input Voltage	PGAx_EN = 0, PGAx_SLEW_DIS = 1				
	0 dBFS		0.98		V rms
	0 dBFS		2.78		V p-p
Dynamic Range ¹	20 Hz to 20 kHz, -60 dB input				
With A-Weighted Filter (RMS)	Enhanced performance		106		dB
	Normal performance		106		dB
	Power saving		105		dB
	Voice wake up		100		dB
With Flat 20 Hz to 20 kHz Filter	Enhanced performance		104		dB
	Normal performance		104		dB
	Power saving		103		dB
	Voice wake up		98		dB
SNR ²					
With A-Weighted Filter (RMS)	Enhanced performance		106		dB
	Normal performance		106		dB
	Power saving		104		dB
	Voice wake up		99		dB
With Flat 20 Hz to 20 kHz Filter	Enhanced performance		103		dB
	Normal performance		103		dB
	Power saving		102		dB
	Voice wake up		98		dB
Interchannel Gain Mismatch			40		mdB
THD + N	20 Hz to 20 kHz, -1 dB full-scale output				
	Enhanced performance		-95		dBFS
	Normal performance		-95		dBFS
	Power saving		-95		dBFS
	Voice wake up		-95		dBFS
Offset Error			±0.2		mV
Gain Error			±0.2		dB
Interchannel Isolation	CM capacitor = 1 µF		100		dB
PSRR	CM capacitor = 1 µF				
	100 mV p-p at 1 kHz		70		dB
	100 mV p-p at 10kHz		70		dB

SPECIFICATIONS

Table 1.

Parameter	Test Conditions/Comments	Min	Typ	Max	Unit	
SINGLE-ENDED PGA INPUT	Full-Scale Input Voltage	PGAx_EN = 1	0 dBFS	0.49		V rms
			0 dBFS	1.39		V p-p
	Dynamic Range ¹ With A-Weighted Filter (RMS)	20 Hz to 20 kHz, -60 dB input	Enhanced performance	100		dB
			Normal performance	100		dB
			Power saving	99		dB
			Voice wake up	97		dB
	With Flat 20 Hz to 20 kHz Filter	Enhanced performance	Enhanced performance	96		dB
			Normal performance	96		dB
			Power saving	96		dB
			Voice wake up	94		dB
	SNR ²	With A-Weighted Filter (RMS)	Enhanced performance	100		dB
			Normal performance	100		dB
			Power saving	99		dB
			Voice wake up	97		dB
With Flat 20 Hz to 20 kHz Filter		Enhanced performance	Enhanced performance	96		dB
			Normal performance	96		dB
			Power saving	96		dB
			Voice wake up	94		dB
THD + N	20 Hz to 20 kHz, -1 dBFS	Enhanced performance	-78		dBFS	
		Normal performance	-78		dBFS	
		Power saving	-78		dBFS	
		Voice wake up	-78		dBFS	
			0		24	dB
PGA Gain Range		0		24	dB	
PGA Gain Variation	Standard deviation	With 0 dB Setting	0.05		dB	
		With 24 dB Setting	0.15		dB	
Interchannel Gain Mismatch			40		mdB	
Offset Error			0.3		mV	
Gain Error			±0.2		dB	
Interchannel Isolation	CM capacitor = 1 µF		83		dB	
PSRR	CM capacitor = 1 µF	100 mV p-p at 1 kHz	70		dB	
		100 mV p-p at 10 kHz	50		dB	
DIFFERENTIAL PGA INPUT	Full-Scale Input Voltage	PGAx_EN = 1	0 dBFS	0.98		V rms
			0 dBFS	2.78		V p-p
	Dynamic Range ¹ With A-Weighted Filter (RMS)	20 Hz to 20 kHz, -60 dB input	Enhanced performance	103		dB
			Normal performance	103		dB
			Power saving	103		dB
			Voice wake up	97		dB
	With Flat 20 Hz to 20 kHz Filter	Enhanced performance	Enhanced performance	101		dB
			Normal performance	101		dB
			Power saving	100		dB
			Voice wake up	96		dB

SPECIFICATIONS

Table 1.

Parameter	Test Conditions/Comments	Min	Typ	Max	Unit	
SNR ² With A-Weighted Filter (RMS)	Enhanced performance		102		dB	
	Normal performance		102		dB	
	Power saving		102		dB	
	Voice wake up		97		dB	
	With Flat 20 Hz to 20 kHz Filter	Enhanced performance		100		dB
		Normal performance		100		dB
		Power saving		100		dB
		Voice wake up		95		dB
THD + N	20 Hz to 20 kHz, -1 dBFS					
	Enhanced performance		-95		dBFS	
	Normal performance		-95		dBFS	
	Power saving		-95		dBFS	
PGA Gain Range		0		24	dB	
PGA Gain Variation	With 0 dB Setting		0.05		dB	
	With 24 dB Setting		0.15		dB	
Interchannel Gain Mismatch			40		mdB	
Offset Error			±0.2		mV	
Gain Error			±0.2		dB	
Interchannel Isolation	CM capacitor = 1 µF		100		dB	
PSRR	CM capacitor = 1 µF					
	100 mV p-p at 1 kHz		70		dB	
	100 mV p-p at 10 kHz		70		dB	
DIGITAL-TO-ANALOG CONVERTERS (DACs)						
Internal Converter Resolution	All digital-to-analog converters		24		Bits	
Digital Gain						
Step			0.375		dB	
Range		-71.25		+24	dB	
Ramp Rate			4.5		dB/ms	
DAC DIFFERENTIAL OUTPUT						
Full-Scale Output Voltage	0 dBFS to DAC		1.0		V rms	
Dynamic Range ¹	20 Hz to 20 kHz, -60 dB input					
	Enhanced performance		110		dB	
With Flat 20 Hz to 20 kHz Filter	Normal performance		106		dB	
	Enhanced performance		107		dB	
SNR ²	Normal performance		103		dB	
	20 Hz to 20 kHz					
With A-Weighted Filter (RMS)	Enhanced performance		110		dB	
	Normal performance		106		dB	
With Flat 20 Hz to 20 kHz Filter	Enhanced performance		106		dB	
	Normal performance		103		dB	
Output Noise	20 Hz to 20 kHz					
With A-Weighted Filter (RMS)			3.15		µV	
THD + N Level	Headphone mode					
	32 Ω Load					
	-15 dBFS input, output power (P _{OUT}) = 1 mW, enhanced performance		-96		dBV	
	-15 dBFS input, P _{OUT} = 1 mW, normal performance		-85		dBV	

SPECIFICATIONS

Table 1.

Parameter	Test Conditions/Comments	Min	Typ	Max	Unit
24 Ω Load	-1 dBFS input, enhanced performance		-89		dBV
	-1 dBFS input, normal performance		-80		dBV
	-2 dBFS input, enhanced performance		-89		dBV
	-2 dBFS input, normal performance		-80		dBV
16 Ω Load	-3 dBFS input, enhanced performance		-89		dBV
	-3 dBFS input, normal performance		-80		dBV
THD + N Ratio ³	Headphone mode				
10 k Ω Load	-1 dBFS input, normal performance		-95		dB
300 Ω Load	-1 dBFS input, enhanced performance		-93		dB
600 Ω Load	-1 dBFS input, enhanced performance		-93		dB
Headphone Output Power					
32 Ω Load	AVDD = 1.8 V, <0.1% THD + N		30		mW
24 Ω Load	AVDD = 1.8 V, <0.1% THD + N		40		mW
16 Ω Load	AVDD = 1.8 V, <0.1% THD + N		50		mW
Gain Error			± 2.5		%
DC Offset			± 0.1		mV
PSRR	CM capacitor = 1 μ F				
HPVDD	100 mV p-p at 1 kHz		85		dB
	100 mV p-p at 10 kHz		85		dB
HPVDD_L (LDO Bypass)	100 mV p-p at 1 kHz		90		dB
	100 mV p-p at 10 kHz		90		dB
AVDD Undervoltage Trip Point			1.5		V
CM REFERENCE	CM pin				
Output			0.85		V
Source Impedance			5		k Ω
PHASE LOCKED LOOP (PLL)					
Input Frequency	After input prescale	0.03		36	MHz
Output Frequency		24	49.152	100	MHz
Fractional Limits	Fractional mode, fraction part (numerator (N)/denominator (M))	0.1		0.9	
Integer Limits	Fractional mode, integer part	2		3072	
Lock Time	32 kHz input		6.5		ms
	24.576 MHz input		0.46	0.55	ms
REGULATOR					
Line Regulation			1		mV/V
Load Regulation			0.5		mV/mA

¹ Dynamic range is the ratio of the sum of noise and harmonic power in the band of interest with a -60 dBFS signal present to the full-scale power level in decibels.

² SNR is the ratio of the sum of all noise power in the band of interest with no signal present to the full-scale power level in decibels.

³ 25°C with DAC_MORE_FILT, DAC_LPM enabled with A-weighted filter used.

CRYSTAL AMPLIFIER SPECIFICATIONS

Supply voltages: AVDD = IOVDD = 1.8 V, and DVDD = 0.9 V, unless otherwise noted.

Table 2.

Parameter	Min	Typ	Max	Unit
JITTER		270	500	ps
FREQUENCY RANGE	1		36	MHz
LOAD CAPACITANCE			20	pF

SPECIFICATIONS

DIGITAL INPUT AND OUTPUT SPECIFICATIONS

$-40^{\circ}\text{C} < T_A < +85^{\circ}\text{C}$, and IOVDD = 1.1 V to 1.98 V, unless otherwise noted.

Table 3.

Parameter	Symbols	Test Conditions/Comments	Min	Typ	Max	Unit
INPUT VOLTAGE						
High	V_{IH}		$0.7 \times \text{IOVDD}$			V
Low	V_{IL}				$0.3 \times \text{IOVDD}$	V
	I_{IH}	IOVDD = 1.8 V, input high current (I_{IH}) at $V_{IH} = 1.1$ V			10	μA
	I_{IL}	Input low current (I_{IL}) at $V_{IL} = 0.45$ V			10	μA
OUTPUT VOLTAGE HIGH	V_{OH}					
Drive Strength						
Low		Output high current (I_{OH}) = 1 mA	$0.7 \times \text{IOVDD}$	$0.83 \times \text{IOVDD}$		V
High		$I_{OH} = 3$ mA	$0.7 \times \text{IOVDD}$	$0.83 \times \text{IOVDD}$		V
OUTPUT VOLTAGE LOW	V_{OL}					
Drive Strength						
Low		Output low current (I_{OL}) = 1 mA		$0.1 \times \text{IOVDD}$	$0.3 \times \text{IOVDD}$	V
High		Output low current (I_{OL}) = 3 mA		$0.1 \times \text{IOVDD}$	$0.3 \times \text{IOVDD}$	V
INPUT CAPACITANCE					5	pF

POWER SUPPLY SPECIFICATIONS

Supply voltages: AVDD = HPVDD = IOVDD = 1.8 V and DVDD = 0.9 V, unless otherwise noted. PLL disabled, direct master clock. Digital input/output (I/O) lines loaded with 25 pF.

Table 4.

Parameter	Test Conditions/Comments	Min	Typ	Max	Unit
SUPPLIES					
AVDD Voltage		1.7	1.8	1.98	V
DVDD Voltage		0.85	0.9	1.21	V
IOVDD Voltage		1.1	1.8	1.98	V
HPVDD Voltage		1.7	1.8	1.98	V
HPVDD_L Voltage		1.2		HPVDD	V

POWER-DOWN CURRENT

Supply voltages: AVDD = HPVDD = IOVDD = 1.8 V and DVDD = 0.9 V and was externally supplied. PLL and crystal oscillator was disabled and bypassed.

Table 5.

Parameter	AVDD + HPVDD Current			DVDD Current			IOVDD Current			HPVDD_L Current			Unit
	Min	Typ	Max	Min	Typ	Max	Min	Typ	Max	Min	Typ	Max	
POWER-DOWN CURRENT													
$\overline{\text{PD}}$ Pin Low (Hardware Power Down) PWR_MODE = 00		6.6			56.9			2.6			3		μA
CM_KEEP_ALIVE = 0		11			258			21			3		μA
CM_KEEP_ALIVE = 1		588			258			21			3		μA

SPECIFICATIONS

TYPICAL POWER CONSUMPTION

PLL bypassed with a master clock = 24.576 MHz (external oscillator). DVDD = 0.9 V, and AVDD = HPVDD = IOVDD = 1.8 V was supplied externally. Where applicable, ADC0 and ADC1 were run at 192 kHz, and ADC2 was run at 48 kHz. FastDSP™ was run at 192 kHz (biquad filters with 27-bit precision), and Tensilica DSP was run at 48 kHz. DAC was run at 192 kHz, and DAC_LPM = 0. One serial port input and output, configured as a slave, with a headphone load of 32 Ω was used. The DAC headphone amplifier (HPAMP) was in normal voltage mode. Quiescent current had no signal.

In Table 6, ASRCI and ASRCO are the input and output ports of the asynchronous sample rate converters, FIFO is first in, first out, DMIC is the digital microphone, and PDM is the pulse density modulation.

Table 6.

ADC + PGA Channels	DAC Channels	ASRCI/ASRCO Channels	FIFO and SRAM2	FastDSP Instructions	Equalizer Filters	DMIC/PDM Channels	Interpolator / Decimator Channels	AVDD + HPVDD Current (mA)	DVDD Current (mA)	IOVDD Current (mA)	HPVDD_L Current (mA)
0	1	1/0	N	0	13	0	0	0.99	1.09	0.15	0.003
2	1	0	N	32	13	0	0	2.18	1.87	0.15	0.003
2	1	1/0	N	32	13	0	0	2.18	2.54	0.15	0.003
1	1	1/1	N	0	13	0	0	1.76	1.30	0.22	0.003
3	1	1/3	N	32	13	0	0	2.58	3.04	0.315	0.003
1 (Voice Wake Up)	0	0	Y	0	0	0	0	1.46	1.56	0.15	0.003

Typical active noise cancelling (ANC) settings (phone call with ANC). Master clock = 24.576 MHz (external oscillator and PLL bypassed). DVDD = 0.9 V, and AVDD = HPVDD = IOVDD = 1.8 V was supplied externally. The three ADCs were PGA enabled and configured for headphone input. The DAC was configured for differential headphone operation, and the DAC output was loaded with 32 Ω, and DAC_LPM = 0. One serial port input and output, configured as slave, was used. One input and three output ASRCs were used. FastDSP was run at 24.576 MHz, 32 instructions (biquad filters with 27-bit precision) at 192 kHz. Tensilica DSP was bypassed, quiescent current had no signal, and the input signal level was -15 dBFS.

Table 7.

Operating Voltage	Performance Setting	Power Mode	Typical Current (mA)				Total Power Consumption (mW)	Typical ADC THD + N, Differential Mode (dB FS)	Typical Headphone Output THD + N (dBV), 1 mW Output
			AVDD + HPVDD	DVDD	IOVDD	HPVDD_L			
AVDD = 1.8 V IOVDD = 1.8 V DVDD = 0.9 V	High	Normal voltage	3.04	3.06	0.316	0.003	8.8	-95	Not applicable No load
			7.87	3.06	0.315	0.003	17.49	-95	-96
		Low voltage	2.76	3.06	0.316	0.286	8.63	-95	Not applicable No load
			2.76	3.06	0.316	5.093	14.4	-95	-96
	Normal	Normal voltage	2.58	3.06	0.316	0.003	7.97	-95	Not applicable No load
			7.41	3.06	0.316	0.003	16.66	-95	-85
		Low voltage	2.32	3.06	0.316	0.257	7.8	-95	Not applicable No load
			2.32	3.06	0.316	5.071	13.58	-95	-85

SPECIFICATIONS

DIGITAL FILTERS

Table 8.

Parameter	Test Conditions/Comments	Min	Typ	Max	Unit
ADC INPUT TO DAC OUTPUT PATH					
Pass-Band Ripple	DC to 20 kHz, sampling frequency (f_s) = 192 kHz (ADC_FCOMP = 1, and DAC_FCOMP = 1)			±0.02	dB
Group Delay	f_s = 192 kHz		12.9		µs
	f_s = 384 kHz		7.5		µs
	f_s = 768 kHz		5		µs
SAMPLE RATE CONVERTER					
Pass Band	FSYNC < 63 kHz			$0.475 \times f_s$	kHz
	63 kHz < FSYNC < 112 kHz			$0.4286 \times f_s$	kHz
	FSYNC > 112 kHz		$0.2383 \times f_s$		kHz
Audio Band Ripple	20 Hz to 20 kHz	-0.1		+0.1	dB
Input and Output Sample Frequency Range		7		224	kHz
Dynamic Range	ASRCx_LPM = 0		130		dB
	ASRCx_LPM = 1		130		dB
	ASRCx_LPM_II = 1		130		dB
THD + Noise	20 Hz to 20 kHz, input is typical at 1 kHz and maximum at 20 kHz				
	ASCRx_LPM = 0		-130	-120	dBFS
	ASCRx_LPM = 1		-120	-110	dBFS
	ASCRx_LPM_II = 1		-115	-90	dBFS
Start-Up Time to Lock				25	ms
PDM OUTPUTS					
Dynamic Range	20 Hz to 20 kHz, with A-weighted filter		126		dBFS
THD + N	20 Hz to 20 kHz, -6 dBFS input		-125		dBFS

DIGITAL TIMING SPECIFICATIONS

-40°C < T_A < +85°C, IOVDD = 1.1 V to 1.8 V, and DVDD = 0.9 V to 1.1 V, unless otherwise noted.

Table 9.

Parameter	Limit		Unit	Description
	Min	Max		
MASTER CLOCK				
t _{MPI}	0.037	33.3	µs	MCLKIN period
t _{MPF}	0.037	1.0	µs	30 kHz to 36 MHz input clock using PLL in fractional mode
AUDIO SERIAL PORT				
t _{BL}	18		ns	BCLK_x low pulse width (master and slave modes)
t _{BH}	18		ns	BCLK_x high pulse width (master and slave modes)
f _{BCLK}	0.512	24.576	MHz	BCLK_x frequency
t _{LS}	3		ns	FSYNC_x setup, time to BCLK_x rising (slave mode)
t _{LH}	5		ns	FSYNC_x hold, time from BCLK_x rising (slave mode)
f _{SYNC}	8	768 ¹	kHz	FSYNC_x frequency
t _{SS}	3		ns	SDATAI_x setup, time to BCLK_x rising (master and slave modes)
t _{SH}	10		ns	SDATAI_x hold, time from BCLK_x rising (master and slave modes)
t _{TS}		6	ns	BCLK_x falling to FSYNC_x timing skew (master mode)

SPECIFICATIONS

Table 9.

Parameter	Limit		Unit	Description
	Min	Max		
t_{SOD}	0	16	ns	SDATAO_x delay, time from BCLK_x falling (master and slave modes), IOVDD at 1.62 V minimum
	0	32	ns	SDATAO_x delay, time from BCLK_x falling (master and slave modes), IOVDD at 1.1 V minimum
t_{SOTD}	0	16	ns	BCLK_x falling to SDATAO_x driven in tristate mode
t_{SOTX}	0	16	ns	BCLK_x falling to SDATAO_x tristated in tristate mode
SERIAL PERIPHERAL INTEFACE (SPI) PORT				
f_{SCLK}		24	MHz	SCLK frequency
t_{CCPL}	15		ns	SCLK pulse width low
t_{CCPH}	15		ns	SCLK pulse width high
t_{CLS}	4		ns	\overline{SS} setup, time to SCLK rising
t_{CLH}	18		ns	\overline{SS} hold, time from SCLK rising
t_{CLPH}	10		ns	\overline{SS} pulse width high
t_{CDS}	8		ns	MOSI setup, time to SCLK rising
t_{CDH}	6		ns	MOSI hold, time from SCLK rising
t_{COD}		17	ns	MISO delay, time from SCLK falling
t_{COTS}		24	ns	MISO high-Z, time from \overline{SS} rising
I ² C PORT				
f_{SCL}		1	MHz	SCL frequency
t_{SCLH}	0.26		μ s	SCL high
t_{SCLL}	0.5		μ s	SCL low
t_{SCS}	0.26		μ s	SCL rise setup time (to SDA falling), relevant for repeated start condition
t_{SCR}		120	ns	SCL and SDA rise time, $C_{LOAD} = 400$ pF
t_{SCH}	0.26		μ s	SCL fall hold time (from SDA falling), relevant for start condition
t_{DS}	50		ns	SDA setup time (to SCL rising)
t_{SCF}		120	ns	SCL and SDA fall time, $C_{LOAD} = 400$ pF
t_{BFT}	0.5		μ s	SCL rise setup time (to SDA rising), relevant for stop condition
QSPI				
f_{QCLK}		50 ²	MHz	QSPIM_CLK frequency
UART				
		1.152	Mbps	Baud rate
GENERAL-PURPOSE INPUT/OUTPUT (GPIO) PINS				
t_{GIL}		$1.5 \times 1/f_S$	μ s	MPx input latency, time until high or low value is read by core
t_{RLPW}	20		ns	\overline{PD} low pulse width
DIGITAL MICROPHONE				
t_{CF}^3		12	ns	Digital microphone clock fall time
t_{CR}^3		14	ns	Digital microphone clock rise time
t_{SETUP}	10		ns	Digital microphone data setup time
t_{HOLD}	3		ns	Digital microphone data hold time

SPECIFICATIONS

Table 9.

Parameter	Limit		Unit	Description
	Min	Max		
PDM OUTPUT				
f_{PDM_CLK}		3.072	MHz	PDM clock frequency 3 MHz setting
		6.144	MHz	6 MHz setting
t_{CF}^3		12	ns	Digital PDM clock output fall time
t_{CR}^3		14	ns	Digital PDM clock output rise time
t_{HOLD}	35	46	ns	PDM data hold time

- ¹ Stereo, 16 bit per channel only at 768 kHz.
- ² Measured when IOVDD = 1.8 V house temperature.
- ³ Digital microphone clock rise and fall times are measured at 2 mA drive strength with 25 pF load.

Digital Timing Diagrams

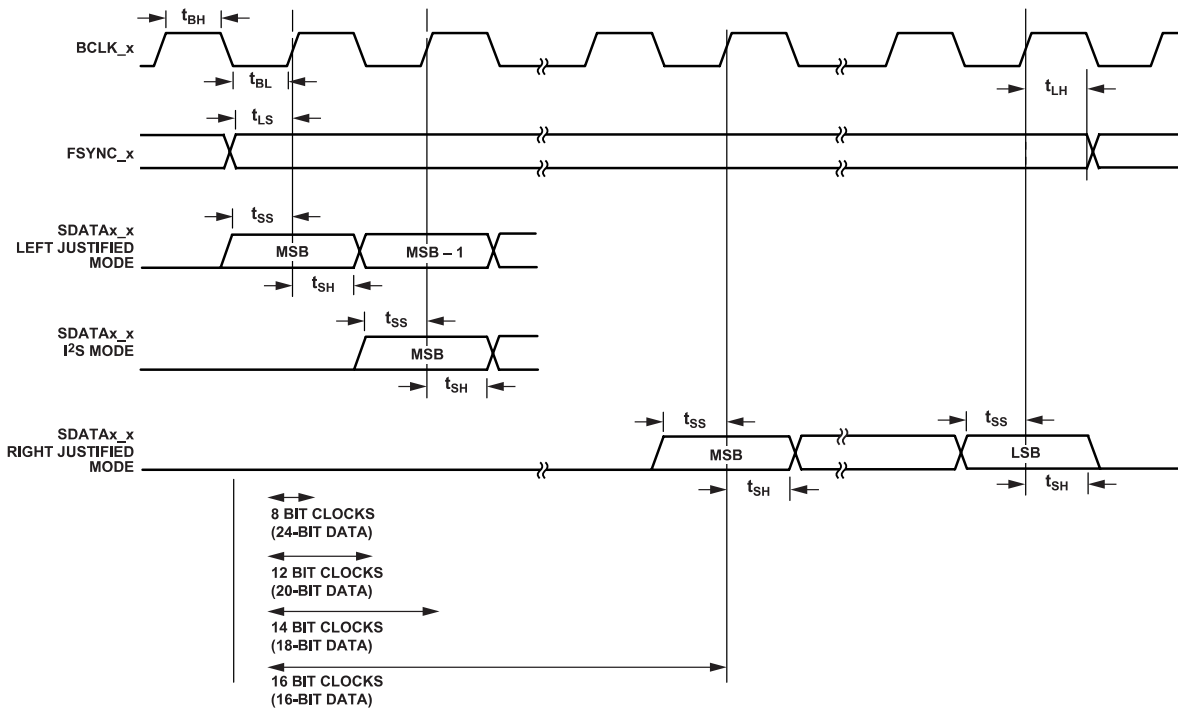

Figure 2. Serial Input Port Timing Diagram

002

SPECIFICATIONS

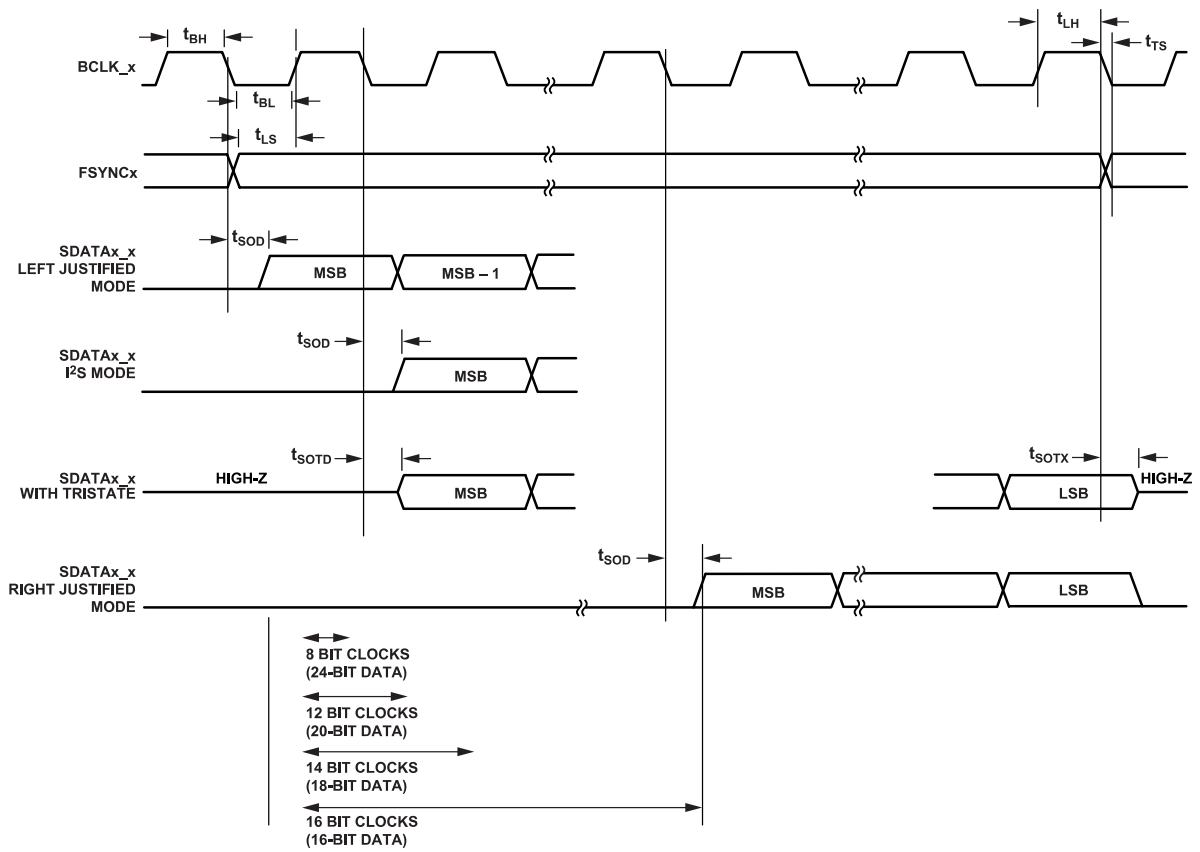

Figure 3. Serial Output Port Timing Diagram

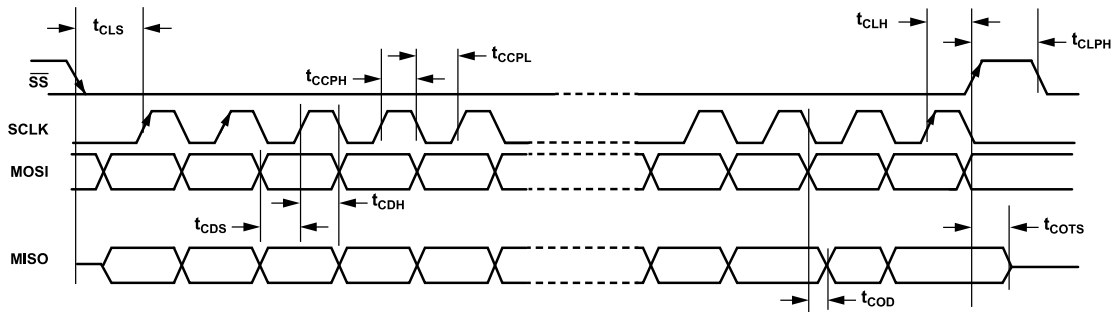

Figure 4. SPI Port Timing Diagram

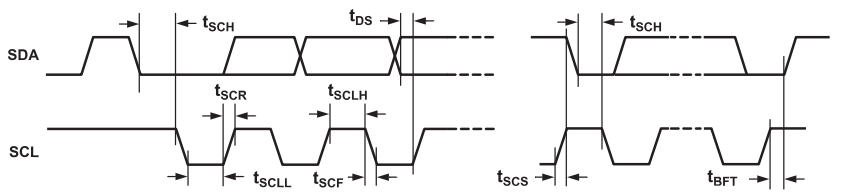

Figure 5. I²C Port Timing Diagram

SPECIFICATIONS

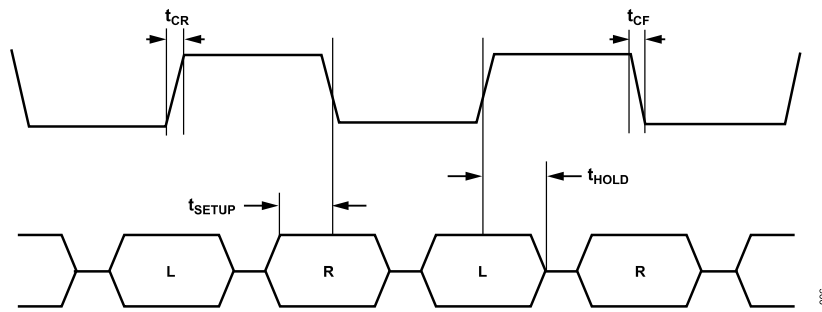

Figure 6. Digital Microphone Timing Diagram

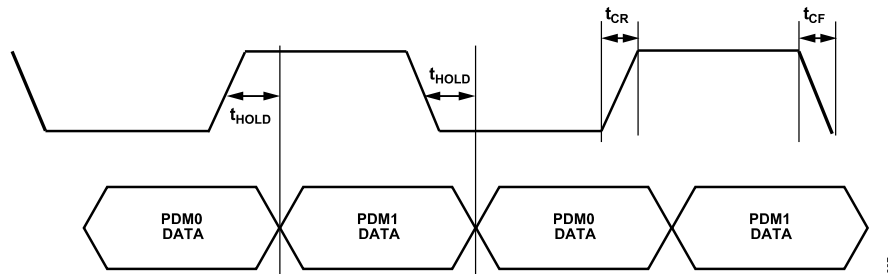

Figure 7. PDM Output Timing Diagram

ABSOLUTE MAXIMUM RATINGS

Table 10.

Parameter	Rating
Power Supply (AVDD, IOVDD, HPVDD, and HPVDD_L)	-0.3 V to +1.98 V
Digital Supply (DVDD)	-0.3 V to +1.21 V
Input Current (Except Supply Pins)	±20 mA
Analog Input Voltage (Signal Pins)	-0.3 V to AVDD + 0.3 V
Digital Input Voltage (Signal Pins)	-0.3 to IOVDD + 0.3 V
Temperature	
Operating Range (Case)	-40°C to +85°C
Storage Range	-65°C to +150°C

Stresses at or above those listed under Absolute Maximum Ratings may cause permanent damage to the product. This is a stress rating only; functional operation of the product at these or any other conditions above those indicated in the operational section of this specification is not implied. Operation beyond the maximum operating conditions for extended periods may affect product reliability.

THERMAL RESISTANCE

Thermal performance is directly linked to printed circuit board (PCB) design and operating environment. Careful attention to PCB thermal design is required.

θ_{JA} and θ_{JC} are determined according to JESD-51-9 on a 4-layer PCB with natural convection cooling.

Table 11. Thermal Resistance

Package Type	θ_{JA} ¹	θ_{JC} ¹	Unit
CB-56-6	82.7	0.84	°C/W

¹ Thermal impedance simulated values are based on a JEDEC 2S2P thermal test board with two thermal vias. See JEDEC JESD-51.

ELECTROSTATIC DISCHARGE (ESD) RATINGS

The following ESD information is provided for handling of ESD-sensitive devices in an ESD protected area only.

Human body model (HBM) per ANSI/ESDA/JEDEC JS-001.

Charged device model (CDM) per ANSI/ESDA/JEDEC JS-002.

ESD Ratings for the ADAU1860

Table 12. ADAU1860, 56-Ball WLCSP

ESD Model	Withstand Threshold (V)	Class
HBM	1000 V	1C
CDM	500 V	C2A

ESD CAUTION



ESD (electrostatic discharge) sensitive device. Charged devices and circuit boards can discharge without detection. Although this product features patented or proprietary protection circuitry, damage may occur on devices subjected to high energy ESD. Therefore, proper ESD precautions should be taken to avoid performance degradation or loss of functionality.

PIN CONFIGURATION AND FUNCTION DESCRIPTIONS

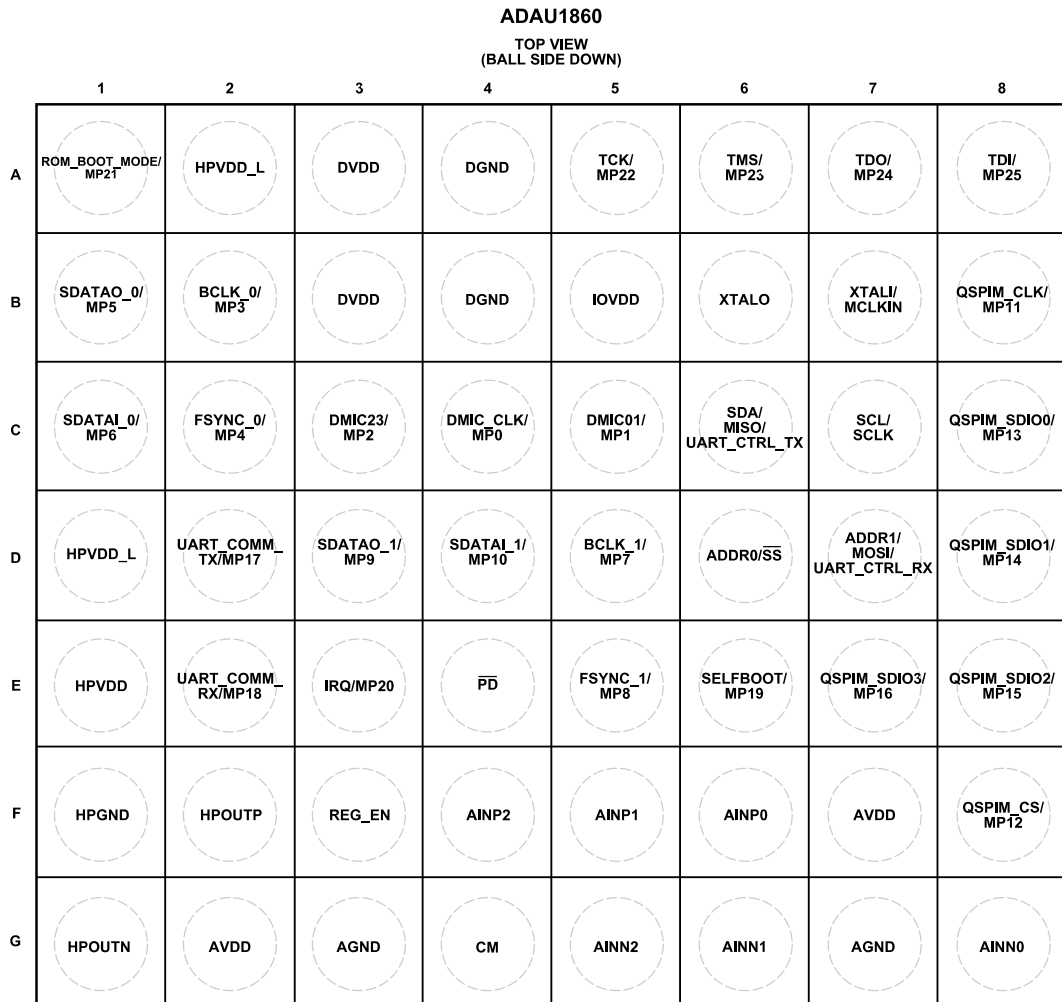

Figure 8. Pin Configuration (Top View)

808

Table 13. Pin Function Descriptions

Ball No.	Mnemonic	Type ¹	Description
A1	ROM_BOOT_MODE/MP21	D_IO	ROM Boot-Up Mode. Use Boot-Up Mode 1 when connecting to IOVDD and use Boot-Up Mode 2 when connecting to ground. Multipurpose I/O 21 (MP21).
A2	HPVDD_L	PWR	Power Supply for the Internal Low Dropout (LDO) Regulator and Headphone Amplifier Power.
A3	DVDD	PWR	Digital Core Supply. The digital supply can be generated from an on-board regulator or supplied directly from an external supply. In each case, decouple DVDD to DGND with a 1 μ F and a 0.1 μ F capacitor.
A4	DGND	PWR	Digital Ground. The AGND and DGND pins can be tied directly together in a common ground plane.
A5	TCK/MP22	D_IO	JTAG Port Clock Input. Multipurpose I/O 22 (MP22).
A6	TMS/MP23	D_IO	JTAG Port Mode Selection. Multipurpose I/O 23 (MP23).
A7	TDO/MP24	D_IO	JTAG Port Data Output. Multipurpose I/O 24 (MP24).
A8	TDI/MP25	D_IO	JTAG Port Data Input. Multipurpose I/O 25 (MP25).
B1	SDATAO_0/MP5	D_IO	Serial Audio Port 0 Output Data (SDATAO_0). Multipurpose I/O 5 (MP5).

PIN CONFIGURATION AND FUNCTION DESCRIPTIONS

Table 13. Pin Function Descriptions

Ball No.	Mnemonic	Type ¹	Description
B2	BCLK_0/MP3	D_IO	Serial Audio Port 0 Bit Clock (BCLK_0). Multipurpose I/O 3 (MP3).
B3	DVDD	PWR	Digital Core Supply. The digital supply can be generated from an on-board regulator or supplied directly from an external supply. In each case, decouple DVDD to DGND with a 1 μ F and 0.1 μ F capacitor.
B4	DGND	PWR	Digital Ground. The AGND and DGND pins can be tied together in a common ground plane.
B5	IOVDD	PWR	Supply for Digital Input and Output Pins. The digital output pins are supplied from IOVDD, and this sets the highest input voltage that can be seen on the digital input pins. The current draw of IOVDD is variable because it is dependent on the loads of the digital outputs. Decouple IOVDD to DGND with a 0.1 μ F capacitor at least.
B6	XTALO	A_OUT	Crystal Clock Output. The XTALO pin is the output of the crystal amplifier and must not be used to provide a clock to other ICs in the system.
B7	XTALI/MCLKIN	D_IN	Crystal Clock Input (XTALI). Master Clock Input (MCLKIN).
B8	QSPIM_CLK/MP11	D_IO	Quad Master SPI Clock (QSPIM_CLK). Multipurpose I/O 11 (MP11).
C1	SDATAI_0/MP6	D_IO	Serial Audio Port 0 Input Data (SDATAI_0). Multipurpose I/O 6 (MP6).
C2	FSYNC_0/MP4	D_IO	Serial Audio Port 0 Frame Sync/Left Right Clock (FSYNC_0). Multipurpose I/O 4 (MP4).
C3	DMIC23/MP2	D_IO	Digital Microphone Stereo Input 2 and Digital Microphone Stereo Input 3 (DMIC23). Multipurpose I/O 2 (MP2).
C4	DMIC_CLK/MP0	D_IO	Digital Microphone Clock Output. Multipurpose I/O 0 (MP0).
C5	DMIC01/MP1	D_IO	Digital Microphone Stereo Input 0 and Digital Microphone Stereo Input 1 (DMIC01). Multipurpose I/O 1 (MP1).
C6	SDA/MISO/ UART_CTRL_TX	D_IO	I ² C Data (SDA). Th SDA pin is a bidirectional open-collector. The line connected to SDA must have a 2.0 k Ω pull-up resistor. SPI Data Output (MISO). This SPI data output is used for reading back registers and memory locations. MISO is tristated when an SPI read is not active. UART Control Port Data Transmit and Output (UART_CTRL_TX).
C7	SCL/SCLK	D_IO	I ² C Clock (SCL). The SCL pin is always an open-collector input when the device is in I ² C control mode. The line connected to the SCL pin must have a 2.0 k Ω pull-up resistor. SPI Clock (SCLK). The SCLK pin can either run continuously or be gated off between SPI transactions.
C8	QSPIM_SDIO0/MP13	D_IO	Quad Master SPI Data I/O 0 (QSPIM_SDIO0). Multipurpose I/O 13 (MP13).
D1	HPVDD_L	PWR	Headphone Amplifier Power, 1.2 V Analog Supply. Decouple the HPVDD_L pin to HPGND with a 10 μ F capacitor. The PCB trace to HPVDD_L must be wider to supply the higher current necessary for driving the headphone outputs.
D2	UART_COMM_TX/MP17	D_IO	Communication UART Port Data Transmit/Output (UART_COMM_TX). Multipurpose I/O 17 (MP17).
D3	SDATAO_1/MP9	D_IO	Serial Audio Port 1 Output Data (SDATAO_1). Multipurpose I/O 9 (MP9).
D4	SDATAI_1/MP10	D_IO	Serial Audio Port 1 Input Data (SDATAI_1). Multipurpose I/O 10 (MP10).
D5	BCLK_1/MP7	D_IO	Serial Audio Port 1 Bit Clock (BCLK_1). Multipurpose I/O 7 (MP7).
D6	ADDR0/ \overline{SS}	D_IN	I ² C Address 0 (ADDR0). SPI Latch Signal (\overline{SS}). \overline{SS} must go low at the beginning of an SPI transaction and high at the end of a transaction. Each SPI transaction can take a different number of SCLK cycles to complete, depending on the address and read/write bit that are sent at the beginning of the SPI transaction.

PIN CONFIGURATION AND FUNCTION DESCRIPTIONS

Table 13. Pin Function Descriptions

Ball No.	Mnemonic	Type ¹	Description
D7	ADDR1/MOSI/ UART_CTRL_RX	D_IN	I ² C Address 1 (ADDR1). SPI Data Input (MOSI). UART Control Port Data Receiver/Input (UART_CTRL_RX).
D8	QSPIM_SDIO1/MP14	D_IO	Quad Master SPI Data Input/Output 1 (QSPIM_SDIO1). Multipurpose I/O 14 (MP14).
E1	HPVDD	PWR	Headphone Amplifier Power, 1.8 V Analog Supply. Decouple the HPVDD pin to HPGND with a 10 µF capacitor. The PCB trace to HPVDD must be wider to supply the higher current necessary for driving the headphone outputs.
E2	UART_COMM_RX/MP18	D_IO	Communication UART Port Data Receiver/Input (UART_COMM_RX). MultiPurpose I/O 18 (MP18).
E3	IRQ/MP20	D_IO	Interrupt Input/Output. MultiPurpose I/O 20 (MP20).
E4	PD	D_IO	Active Low Power-Down. All digital and analog circuits are powered down. There is an internal pull-down resistor on the PD pin; therefore, the ADAU1860 is held in power-down mode if its input signal is floating while power is applied to the supply pins.
E5	FSYNC_1/MP8	D_IO	Serial Audio Port 1 Frame Sync/Left Right Clock (FSYNC_1). MultiPurpose I/O 8 (MP8).
E6	SELFBOT/MP19	D_IO	Self Boot. Set SELFBOT up to IOVDD at power-up to enable self boot mode. Otherwise, set SELFBOT to GND at start-up. Multipurpose I/O 19 (MP19).
E7	QSPIM_SDIO3/MP16	D_IO	Quad Master SPI Data Input/Output 3 (QSPIM_SDIO3). Multipurpose I/O 16 (MP16).
E8	QSPIM_SDIO2/MP15	D_IO	Quad Master SPI Data Input/Output 2 (QSPIM_SDIO2). Multipurpose I/O 15 (MP15).
F1	HPGND	PWR	Headphone Amplifier Ground.
F2	HPOUTP	A_OUT	Headphone Output Noninverted.
F3	REG_EN	A_IN	Regulator Enable. Tie to AVDD to enable regulator, and tie to ground to disable.
F4	AINP2	A_IN	ADC2 Noninverting Input.
F5	AINP1	A_IN	ADC1 Noninverting Input.
F6	AINP0	A_IN	ADC0 Noninverting Input.
F7	AVDD	PWR	1.8 V Analog Supply. Decouple AVDD to AGND with a 10 µF capacitor.
F8	QSPIM_CS/MP12	D_IO	Quad Master SPI Chip Select. Multipurpose I/O 12 (MP12).
G1	HPOUTN	A_OUT	Headphone Output Inverted.
G2	AVDD	PWR	1.8 V Analog Supply. Decouple AVDD to AGND with a 10 µF capacitor.
G3	AGND	PWR	Analog Ground. The AGND and DGND pins can be tied together in a common ground plane.
G4	CM	A_OUT	Common-Mode Reference Fixed at 0.85 V Nominal. A 1 µF decoupling capacitor must be connected between CM and ground to reduce crosstalk between the ADCs and DACs. The material of the capacitors is not critical. CM can be used to bias external analog circuits as long as these circuits are not drawing current from CM (for example, the noninverting input of an op-amp).
G5	AINN2	A_IN	ADC2 Inverting Input.
G6	AINN1	A_IN	ADC1 Inverting Input.
G7	AGND	PWR	Analog Ground. The AGND and DGND pins can be tied together in a common ground plane.
G8	AINNO	A_IN	ADC0 Inverting Input.

¹ D_IO means digital input/output, PWR means power, A_OUT means analog output, D_IN means digital input, and A_IN means analog input.

TYPICAL PERFORMANCE CHARACTERISTICS

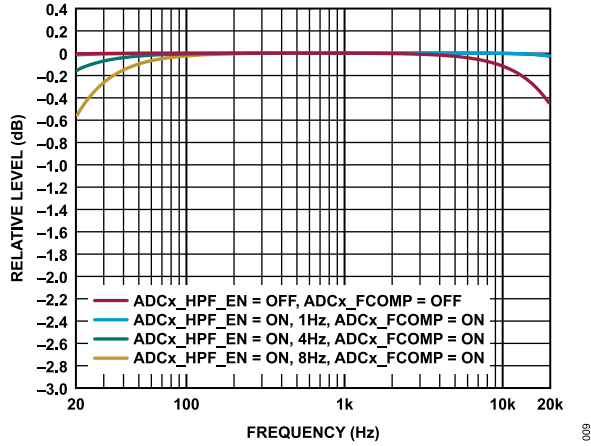

Figure 9. Frequency Response, $f_s = 48$ kHz, -20 dBV Input, Signal Path = AINxx to SDATAO_x, Differential Mode, No PGA

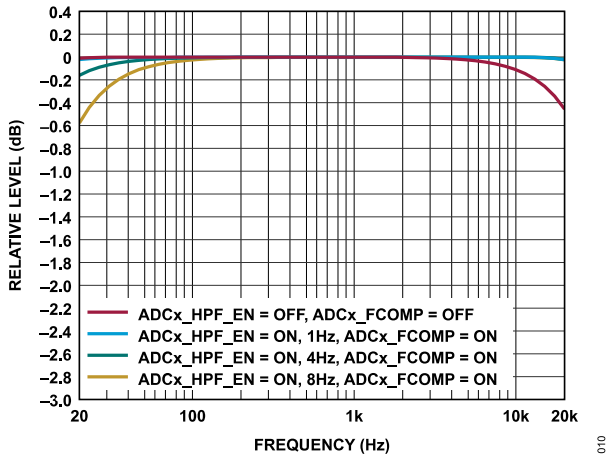

Figure 10. Frequency Response, $f_s = 48$ kHz, -20 dBV Input, Signal Path = AINxx to SDATAO_x, Single-End Mode, No PGA

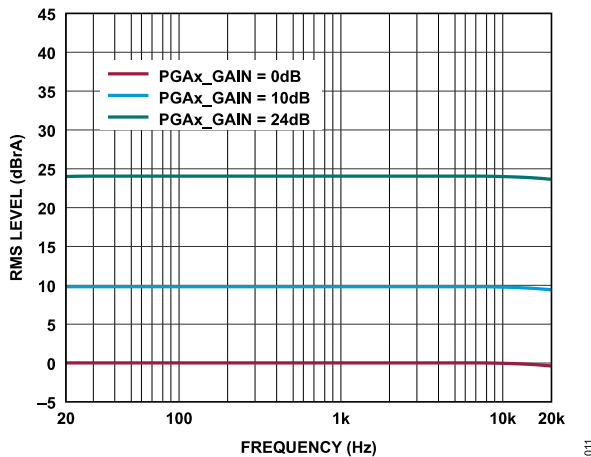

Figure 11. Frequency Response, $f_s = 48$ kHz, Signal Path = AINxx to SDATAO_x, Differential Mode, Output Relative to PGA Gain Settings (0 dB, 10 dB, and 24 dB), ADCx_FCOMP Off

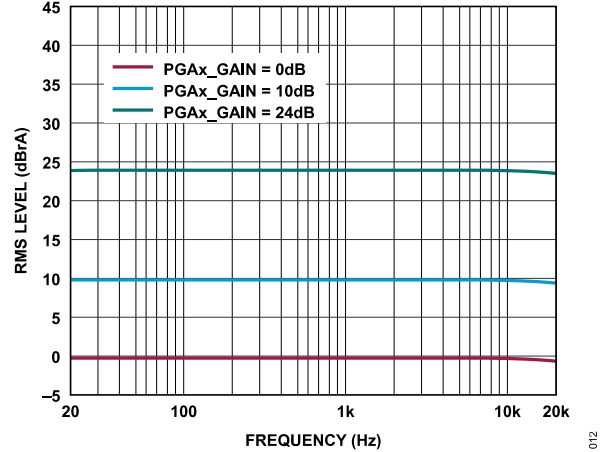

Figure 12. Frequency Response, $f_s = 48$ kHz, Signal Path = AINxx to SDATAO_x, Single-End Mode, Output Relative to PGA Gain Settings (0 dB, 10 dB, and 24 dB), ADCx_FCOMP Off

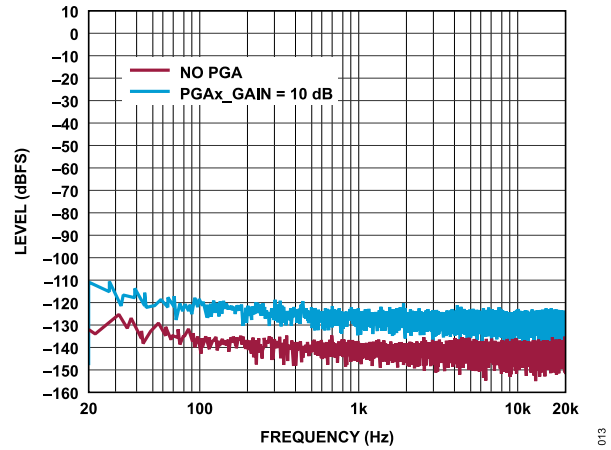

Figure 13. Fast Fourier Transform (FFT), No Signal, $f_s = 48$ kHz, Signal Path = AINxx to SDATAO_x, Differential Mode, No PGA, and 10 dB PGAx_GAIN

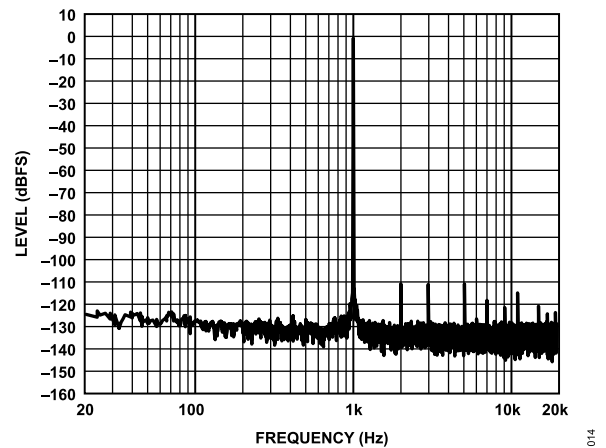

Figure 14. FFT, -1 dBV Input, -1 dBFS Output, $f_s = 48$ kHz, Signal Path = AINxx to SDATAO_x, Differential Mode, No PGA

TYPICAL PERFORMANCE CHARACTERISTICS

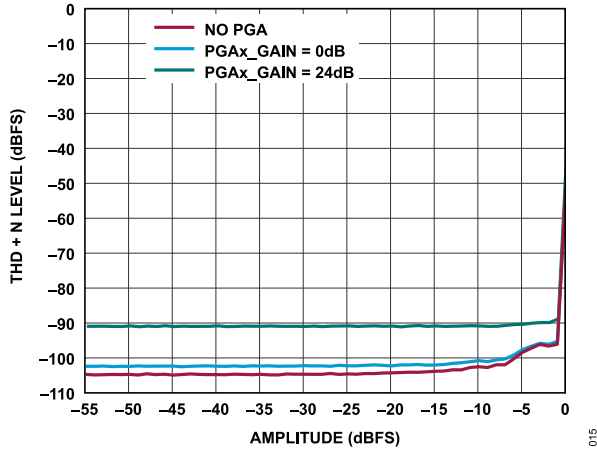

Figure 15. THD + N Level vs. Amplitude, $f_S = 48$ kHz, Signal Path = AINxx to SDATAO_x

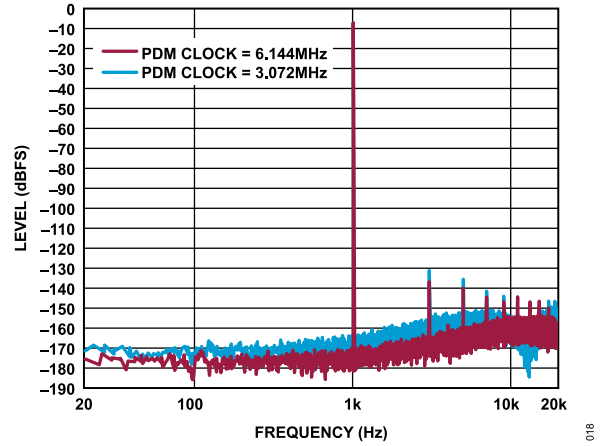

Figure 18. FFT, -7 dBFS, $f_S = 48$ kHz Throughout, Signal Path = SDATAI_x to FastDSP to PDM Output

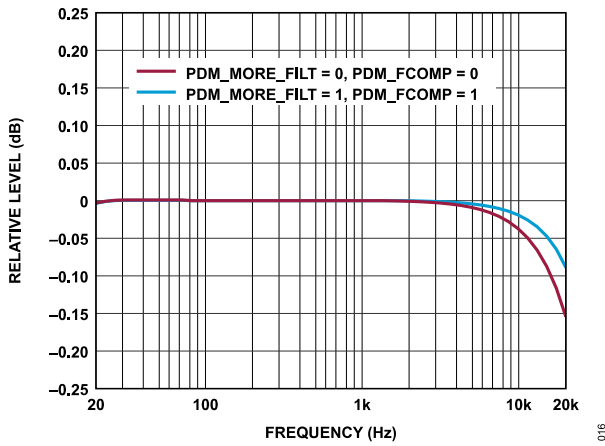

Figure 16. Frequency Response, $f_S = 48$ kHz, Signal Path = SDATAI_x to PDM Output

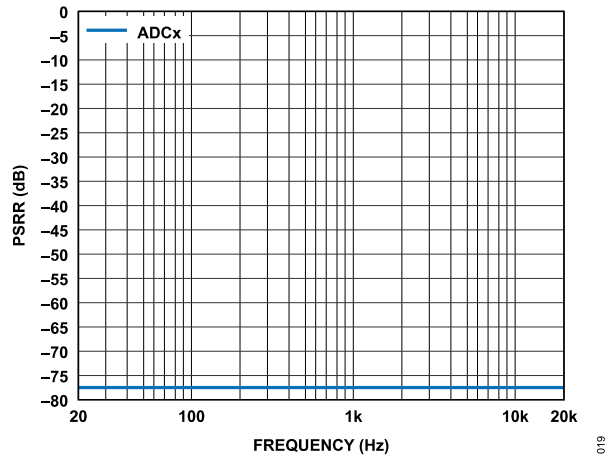

Figure 19. PSRR, Signal Path = AINxx to SDATAO_x, $f_S = 48$ kHz, 100 mV p-p Ripple Input on AVDD, No PGA

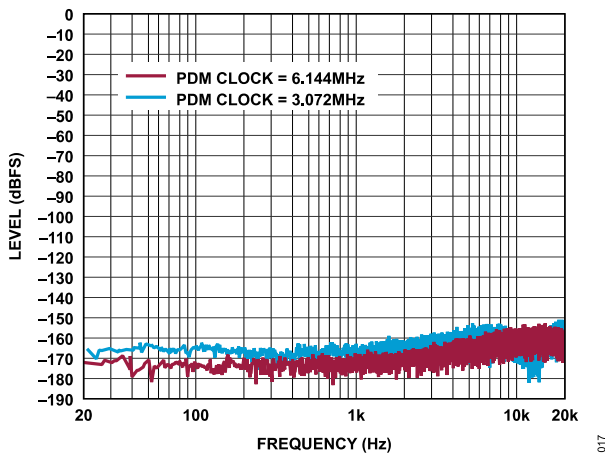

Figure 17. FFT, No Signal, $f_S = 48$ kHz Throughout, Signal Path = SDATAI_x to FastDSP to PDM Output

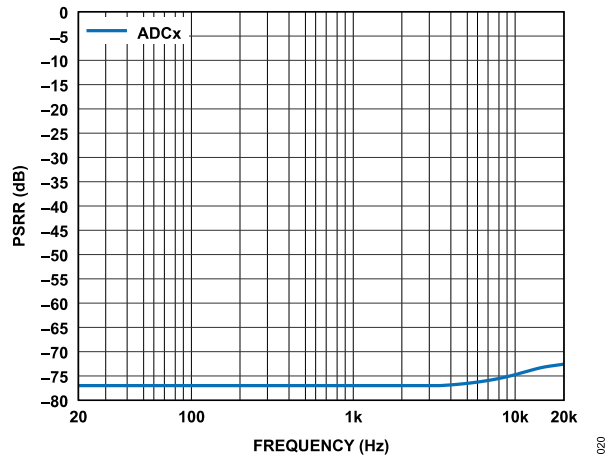

Figure 20. PSRR, Signal Path = AINxx to SDATAO_x, $f_S = 48$ kHz, 100 mV p-p Ripple Input on AVDD, PGA = 0 dB

TYPICAL PERFORMANCE CHARACTERISTICS

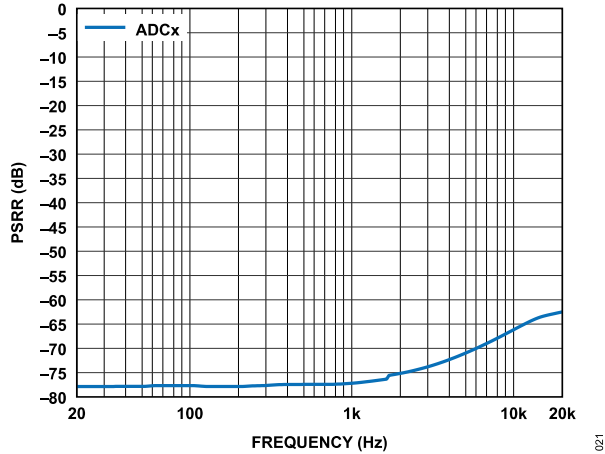

Figure 21. PSRR, Signal Path = AINxx to SDATA0_x, $f_s = 48$ kHz, 100 mV p-p Ripple Input on AVDD, PGA = 10 dB

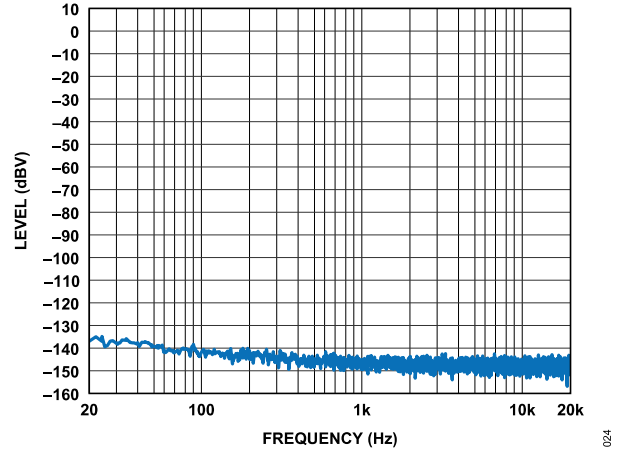

Figure 24. FFT, No Signal, $f_s = 48$ kHz, Signal Path = SDATA1_x to the Output of the DAC Working in Line Output Mode (LOUT), Load = 10 k Ω

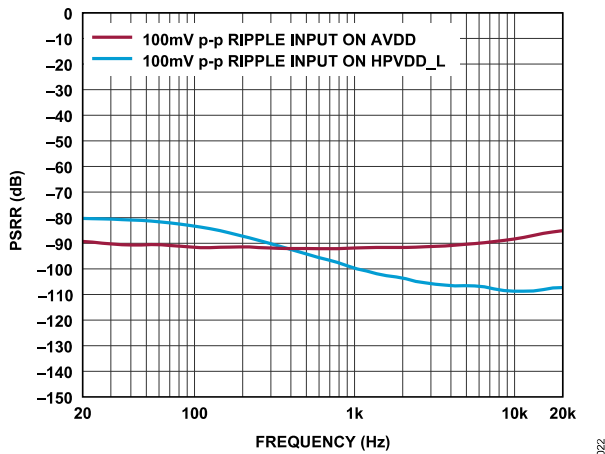

Figure 22. PSRR, Signal Path = SDATA1_x to HPOUT, $f_s = 48$ kHz, 100 mV p-p Ripple Input on HPVDD or HPVDD_L (LDO Bypass)

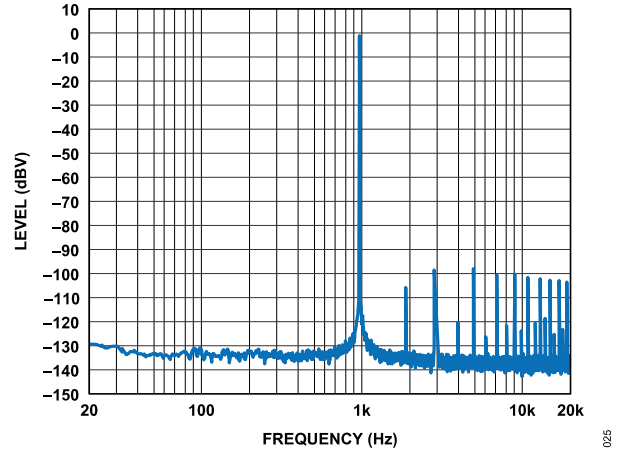

Figure 25. FFT, -1 dBFS, $f_s = 48$ kHz, Signal Path = SDATA1_x to the Output of the DAC Working in Headphone Mode (HPOUT), Load = 32 Ω

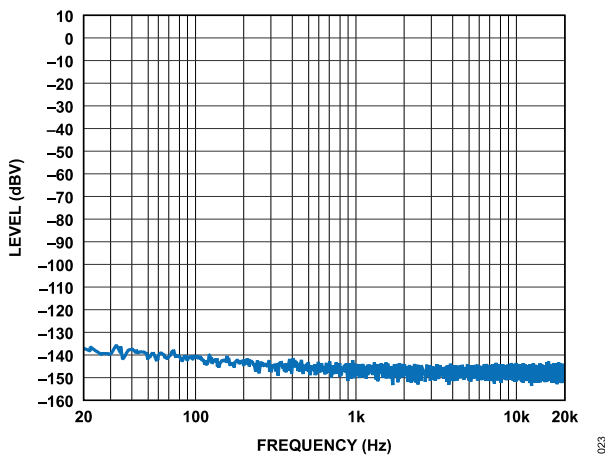

Figure 23. FFT, No Signal, $f_s = 48$ kHz, Signal Path = SDATA1_x to HPOUT, Headphone Mode, Load = 32 Ω

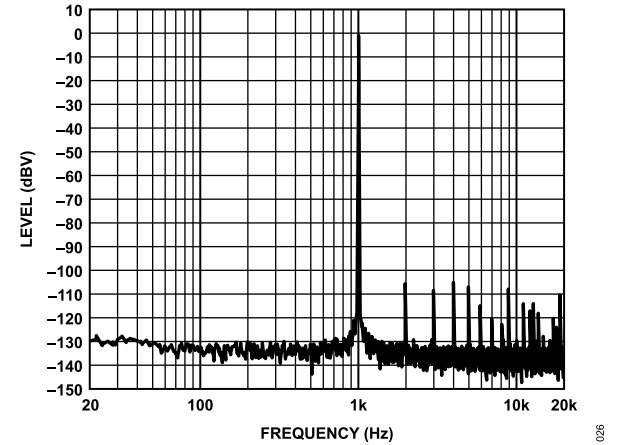

Figure 26. FFT, -1 dBFS, $f_s = 48$ kHz, Signal Path = SDATA1_x to LOUT, Line Output Mode, Load = 10 k Ω

TYPICAL PERFORMANCE CHARACTERISTICS

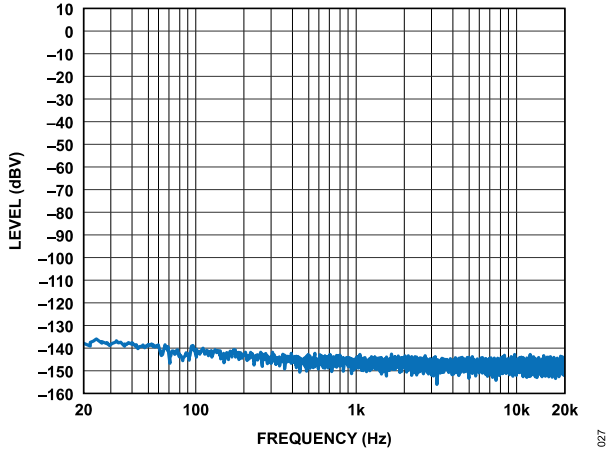

Figure 27. FFT, No Signal, $f_s = 768$ kHz, Signal Path = SDATA1_x to Interpolator to FastDSP to HPOUT, Headphone Mode, Load = 32 Ω

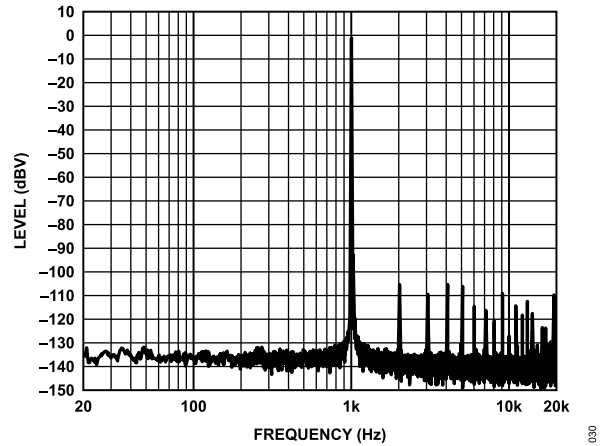

Figure 30. FFT, -1 dBFS, $f_s = 768$ kHz, Signal Path = SDATA1_x to Interpolator to FastDSP to LOUT, Line Output Mode, Load = 10 k Ω

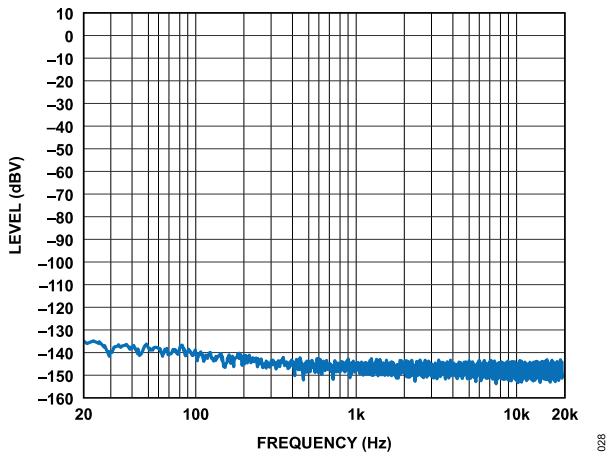

Figure 28. FFT, No Signal, $f_s = 768$ kHz, Signal Path = SDATA1_x to Interpolator to FastDSP to LOUT, Line Output Mode, Load = 32 Ω

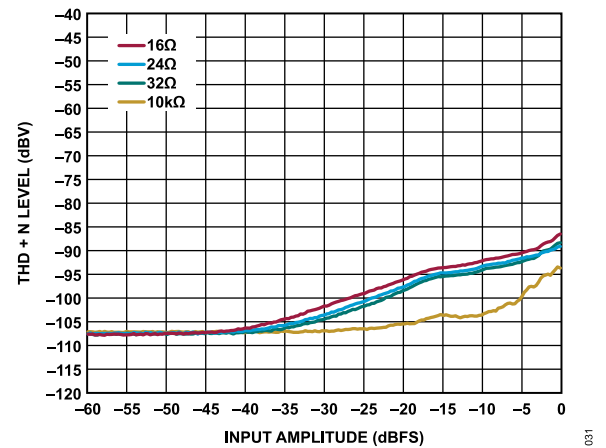

Figure 31. THD + N Level vs. Input Amplitude, $f_s = 48$ kHz, 16 Ω , 24 Ω , 32 Ω , or 10 k Ω (Normal), Signal Path = SDATA1_x to HPOUT/LOUT

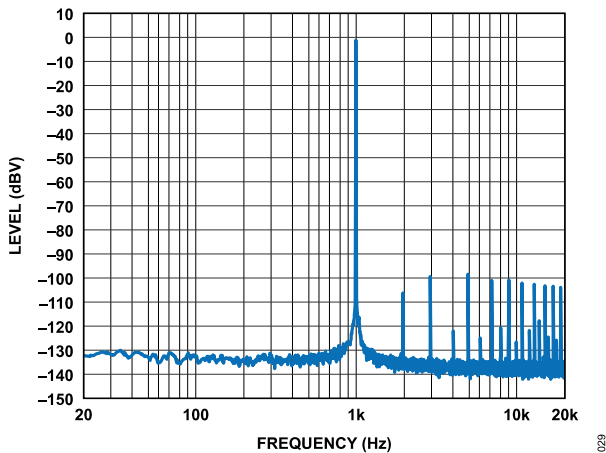

Figure 29. FFT, -1 dBFS, $f_s = 768$ kHz, Signal Path = SDATA1_x to Interpolator to FastDSP to HPOUT, Headphone Mode, Load = 32 Ω

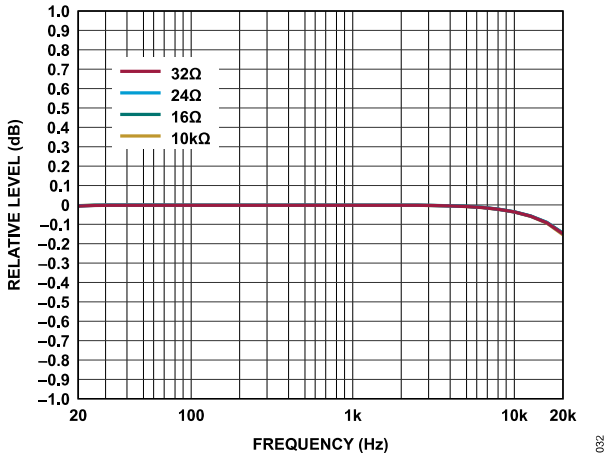

Figure 32. Relative Level vs. Frequency, $f_s = 48$ kHz, Signal Path = SDATA1_x to HPOUT/LOUT, 16 Ω , 24 Ω , 32 Ω , or 10 k Ω

TYPICAL PERFORMANCE CHARACTERISTICS

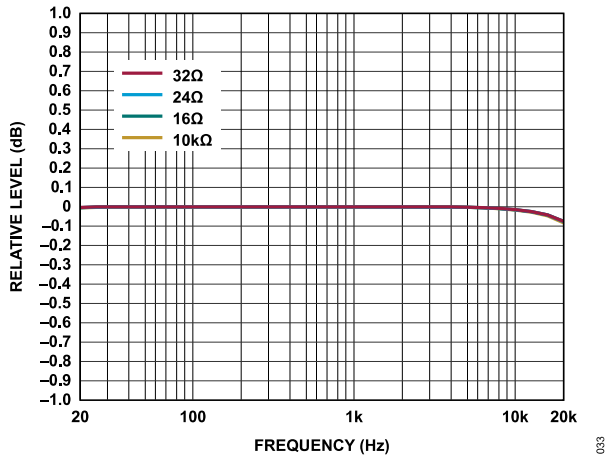

Figure 33. Relative Level vs. Frequency, $f_s = 768$ kHz, Signal Path = SDATAI_x to Interpolator to FastDSP to HPOUT/LOUT, 16 Ω to 10 k Ω

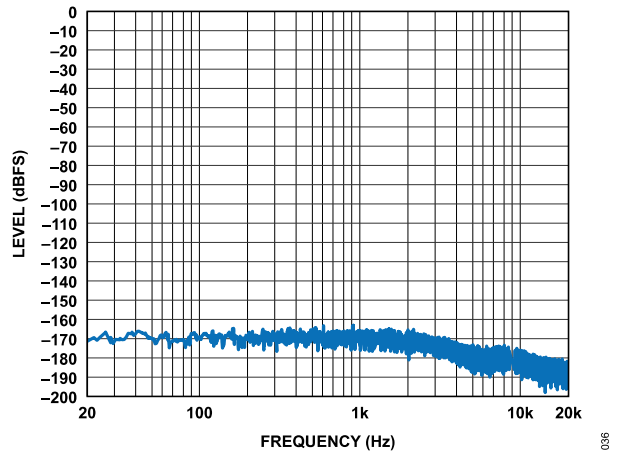

Figure 36. FFT, No Signal, $f_s = 48$ kHz Throughout Except FastDSP = 768 kHz, Signal Path = SDATAI_x to Equalizer to Interpolator to FastDSP to Decimator to SDATAO_x

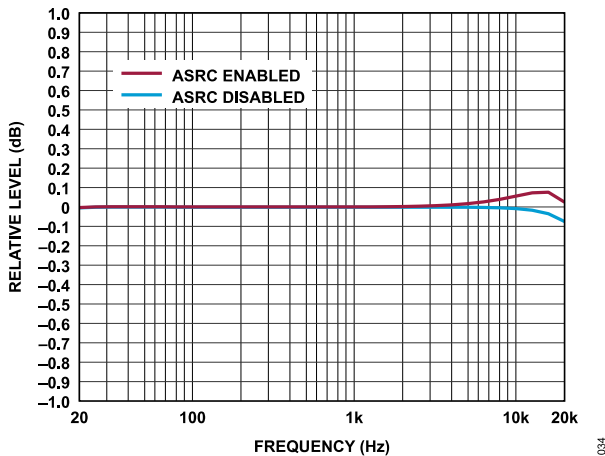

Figure 34. Relative Level vs. Frequency, $f_s = 48$ kHz Throughout Except FastDSP = 768 kHz, Signal Path = SDATAI_x to ASRCI to Equalizer to Interpolator to FastDSP to Decimator to ASRCO to SDATAO_x

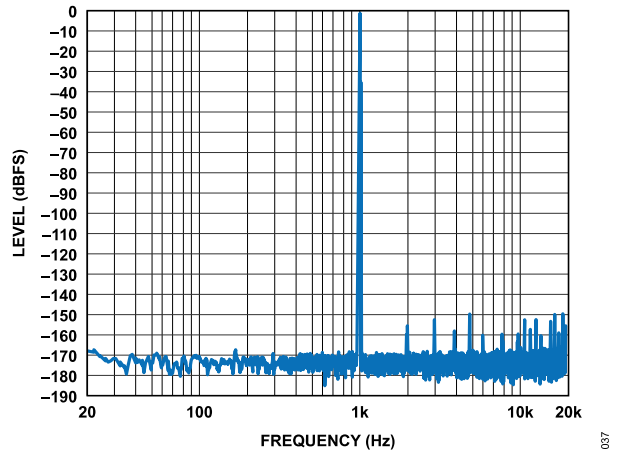

Figure 37. FFT, -1 dBFS Input, $f_s = 48$ kHz Throughout Except FastDSP = 768 kHz, Signal Path = SDATAI_x to ASRCI to Equalizer to Interpolator to FastDSP to Decimator to ASRCO to SDATAO_x

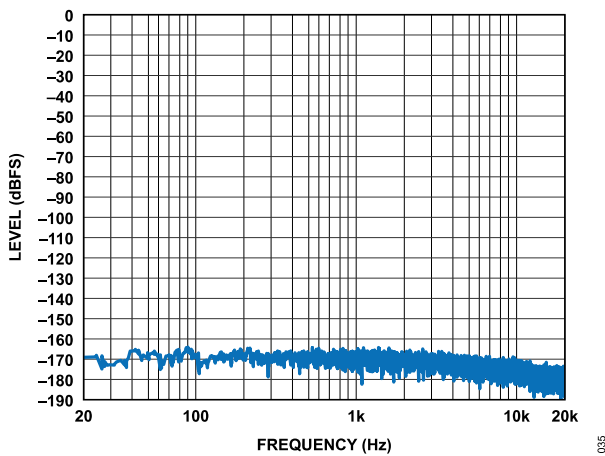

Figure 35. FFT, No Signal, $f_s = 48$ kHz Throughout Except FastDSP = 768 kHz, Signal Path = SDATAI_x to ASRCI to Equalizer to Interpolator to FastDSP to Decimator to ASRCO to SDATAO_x

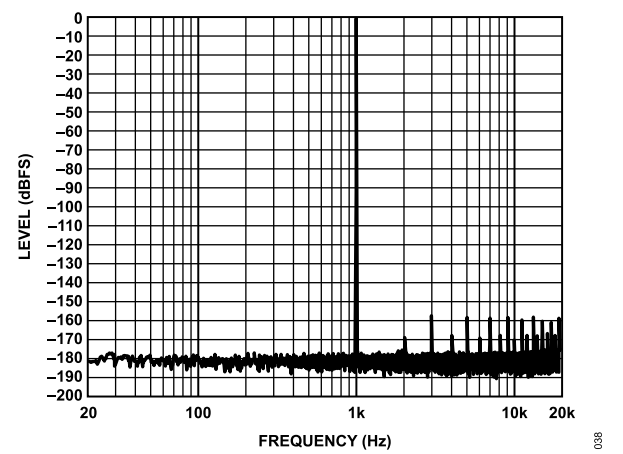

Figure 38. FFT, -1 dBFS Input, $f_s = 48$ kHz Throughout Except FastDSP = 768 kHz, Signal Path = SDATAI_x to Equalizer to Interpolator to FastDSP to Decimator to SDATAO_x

TYPICAL PERFORMANCE CHARACTERISTICS

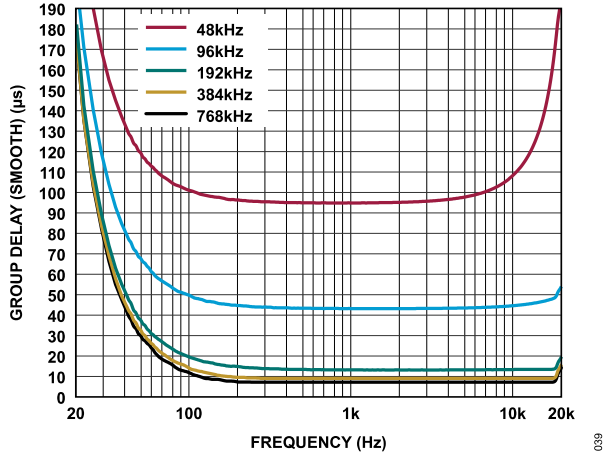

Figure 39. Group Delay (Smooth) vs. Frequency, $f_s = 48 \text{ kHz}$ to 768 kHz , Differential Mode, Signal Path = AINxx to FastDSP to HPOUT/LOUT

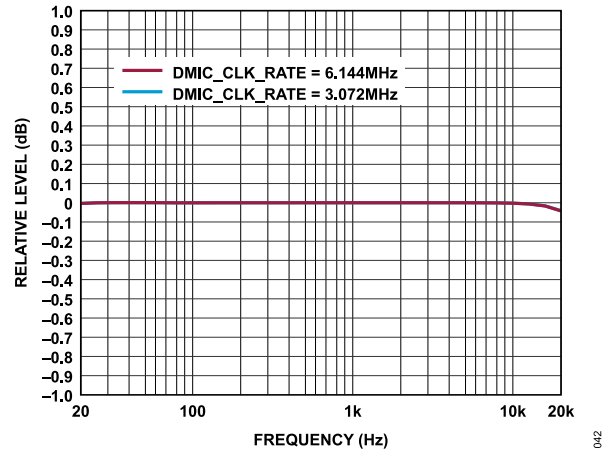

Figure 42. Relative Level vs. Frequency, DMIC_CLK_RATE = 3.072 MHz and 6.144 MHz, Signal Path = DMICxx to SDATAO_x, FCOMP = EN

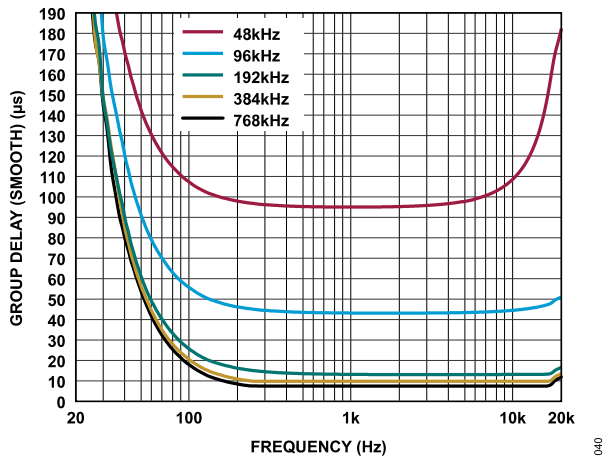

Figure 40. Group Delay (Smooth) vs. Frequency, $f_s = 48 \text{ kHz}$ to 768 kHz , Single-End Mode, Signal Path = AINxx to FastDSP to HPOUT/LOUT

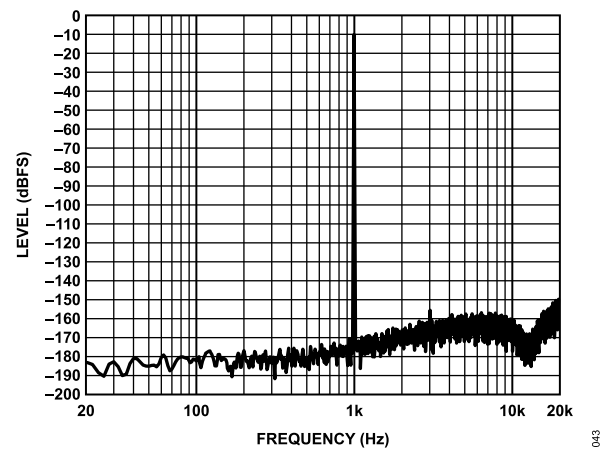

Figure 43. FFT, -10 dBFS Input, DMIC_CLK_RATE = 3.072 MHz, Signal Path = DMICxx to SDATAO_x

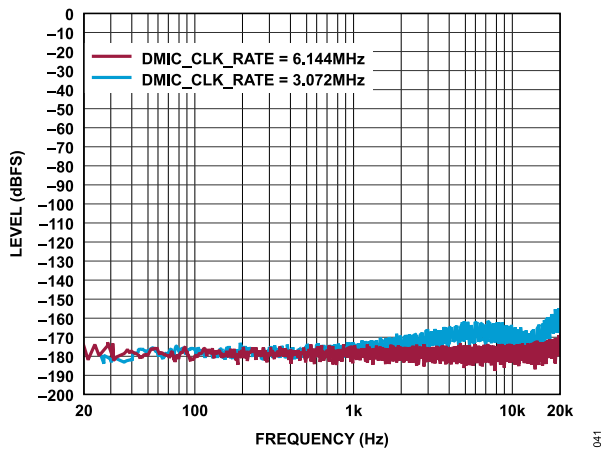

Figure 41. FFT, No Signal, DMIC_CLK_RATE = 3.072 MHz and 6.144 MHz, Signal Path = DMICxx to SDATAO_x

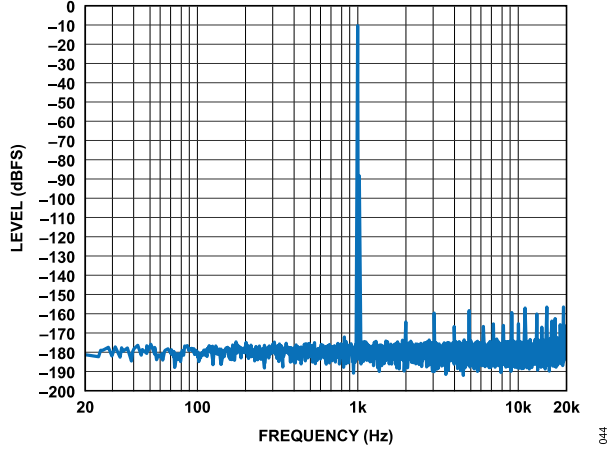

Figure 44. FFT, -10 dBFS Input, DMIC_CLK_RATE = 6.144 MHz, Signal Path = DMICxx to SDATAO_x

TYPICAL PERFORMANCE CHARACTERISTICS

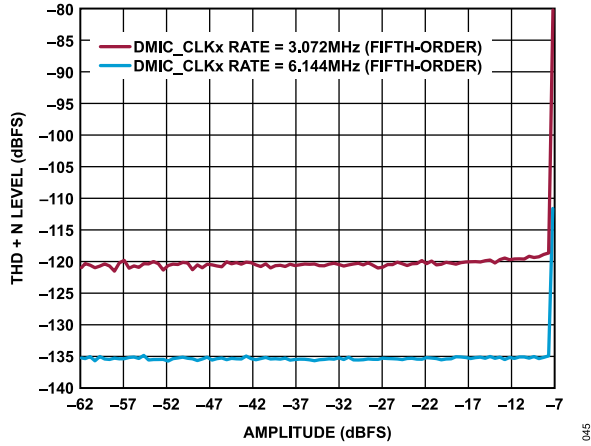

Figure 45. THD + N Level vs. Amplitude, -10 dBFS, DMIC_CLK_RATE = 3.072 MHz and 6.144 MHz (Fifth-Order), Signal Path = DMICxx to SDATAO_x

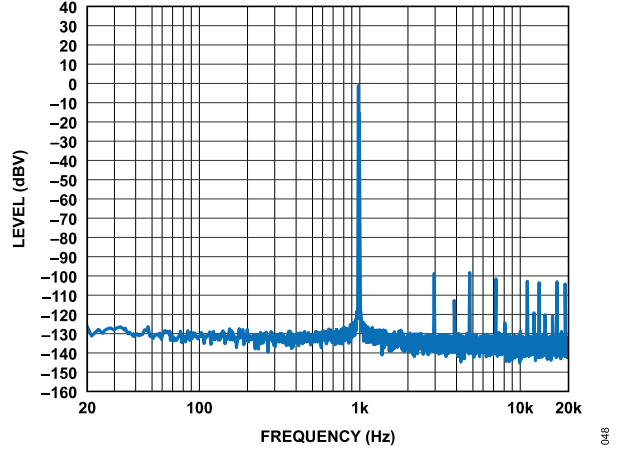

Figure 48. FFT, -1 dBV Input, Differential Mode, Headphone Mode, Load = 32 Ω , f_s = 48 kHz to 768 kHz, Signal Path = AINx to HPOUT

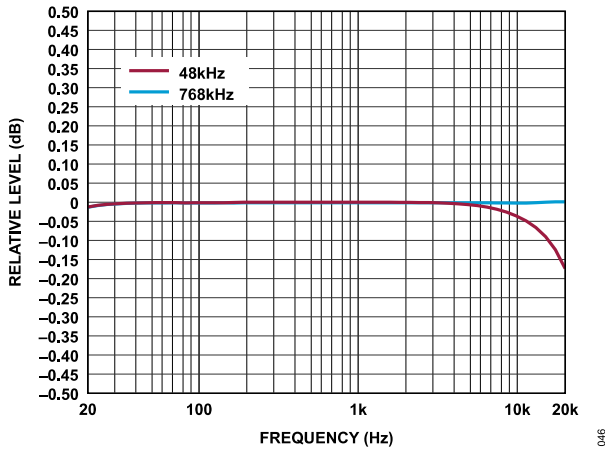

Figure 46. Relative Level vs. Frequency, Differential and Single-End Mode, Headphone and Line Output Mode, Load = 16 Ω to 10 k Ω , f_s = 48 kHz and 768 kHz, Signal Path = AIN0 to DAC

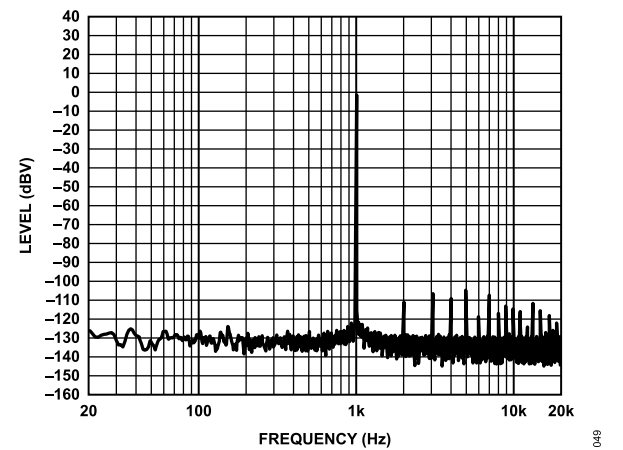

Figure 49. FFT, -1 dBV Input, Differential Mode, Line Output Mode, Load = 10 k Ω , f_s = 48 kHz to 768 kHz, Signal Path = AINx to LOUT

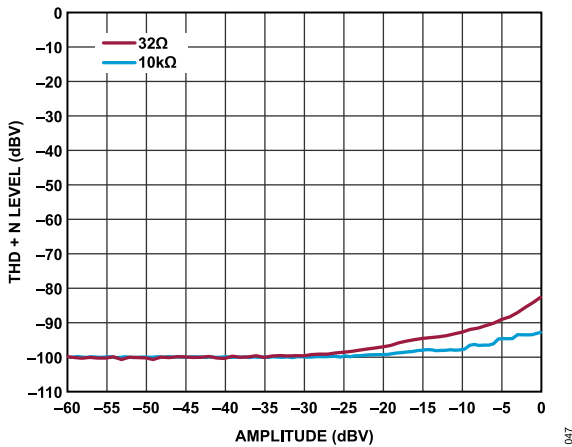

Figure 47. THD + N Level vs. Amplitude, f_s = 48 kHz to 768 kHz, Load = 10 k Ω and 32 Ω , Signal Path = AINx to HPOUT/LOUT

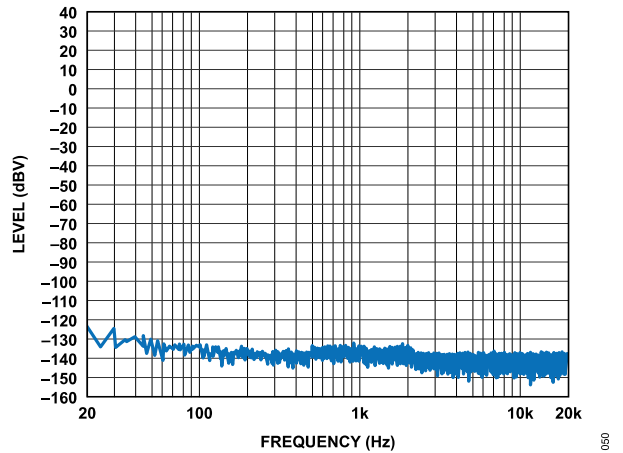

Figure 50. FFT, No Signal, Differential Mode, Load = 32 Ω to 10 k Ω , f_s = 48 kHz to 768 kHz, Signal Path = AINx to HPOUT/LOUT

THEORY OF OPERATION

The ADAU1860 is a low power audio codec with an optimized audio processing core, making it ideal for noise canceling applications that require high quality audio, low power, small size, and low latency.

The 3-channel ADC can achieve a 106 dB SNR. The DAC can achieve a 110 dB SNR and a -95 dB THD + N ratio. The two serial audio ports are compatible with I²S, left justified, right justified, and time division multiplexing (TDM) modes, with tristate for interfacing to digital audio data. The analog operating voltage is 1.8 V, and an optional internal regulator can be used to generate the digital supply voltage. If required, the regulator can be powered down, and the digital supply voltage can be supplied externally, which is determined by the REG_EN pin.

The input signal path includes flexible configurations that can accept differential or single-ended analog microphone inputs as well as up to eight digital microphone inputs. Each input signal has its own PGA for volume adjustment.

The ADCs and DAC are high quality, 24-bit Σ - Δ converters that operate at a selectable 12 kHz to 768 kHz sampling rate, and the ADCs also support an 8 kHz or a 16 kHz sampling rate in voice wake-up mode. The ADCs and DAC have an optional high-pass filter with a cutoff frequency of 1 Hz, 4 Hz and 8 Hz, and fine step digital soft volume controls.

The DAC output is capable of differentially driving a headphone earpiece speaker with 16 Ω impedance or higher. There is also the option to change to LOUT mode when the output is lightly loaded.

The Tensilica HiFi 3z DSP core is optimized for low power audio processing. In addition, the Tensilica HiFi 3z DSP core allows the ADAU1860 to provide flexible solutions to meet more complicated applications.

The FastDSP core has a reduced instruction set that optimizes this codec for noise cancellation. The program and parameter random access memories (RAMs) can be loaded with custom audio processing signal flow built using the [Lark Studio](#) graphical user interface (GUI). The values stored in the parameter RAM control individual signal processing blocks.

The ADAU1860 also has a self boot function that can load the program and parameter RAMs of both cores along with the register settings on power-up using an external flash memory over the quad SPI. The external flash memory is fully memory mapped to the HiFi 3z DSP core bus fabric.

Use the Lark Studio GUI to program and control the cores through the control port. Along with designing and tuning a signal flow, the GUI can configure all of the ADAU1860 registers. The GUI allows anyone with digital or analog audio processing knowledge to design the DSP signal flow and export the flow to a target application. The interface also provides enough flexibility and programmability for an experienced DSP programmer to have control of the design. In the Lark Studio GUI, the user can connect graphical blocks (such as biquad filters, volume controls, and arithmetic operations), compile

the design, and load the program and parameter files into the ADAU1860 memory through the control port. The tool also allows the user to download the design to an external flash memory for self boot operation.

The ADAU1860 can generate the internal clocks from a wide range of input clocks by using the on-board bypassable fractional PLL. The PLL accepts inputs from 30 kHz to 36 MHz. For standalone operation, the clock can be generated using the on-board crystal oscillator.

The ADAU1860 is provided in a small, 56-ball, 2.980 mm x 2.679 mm WLCSP.

SYSTEM BLOCK DIAGRAM

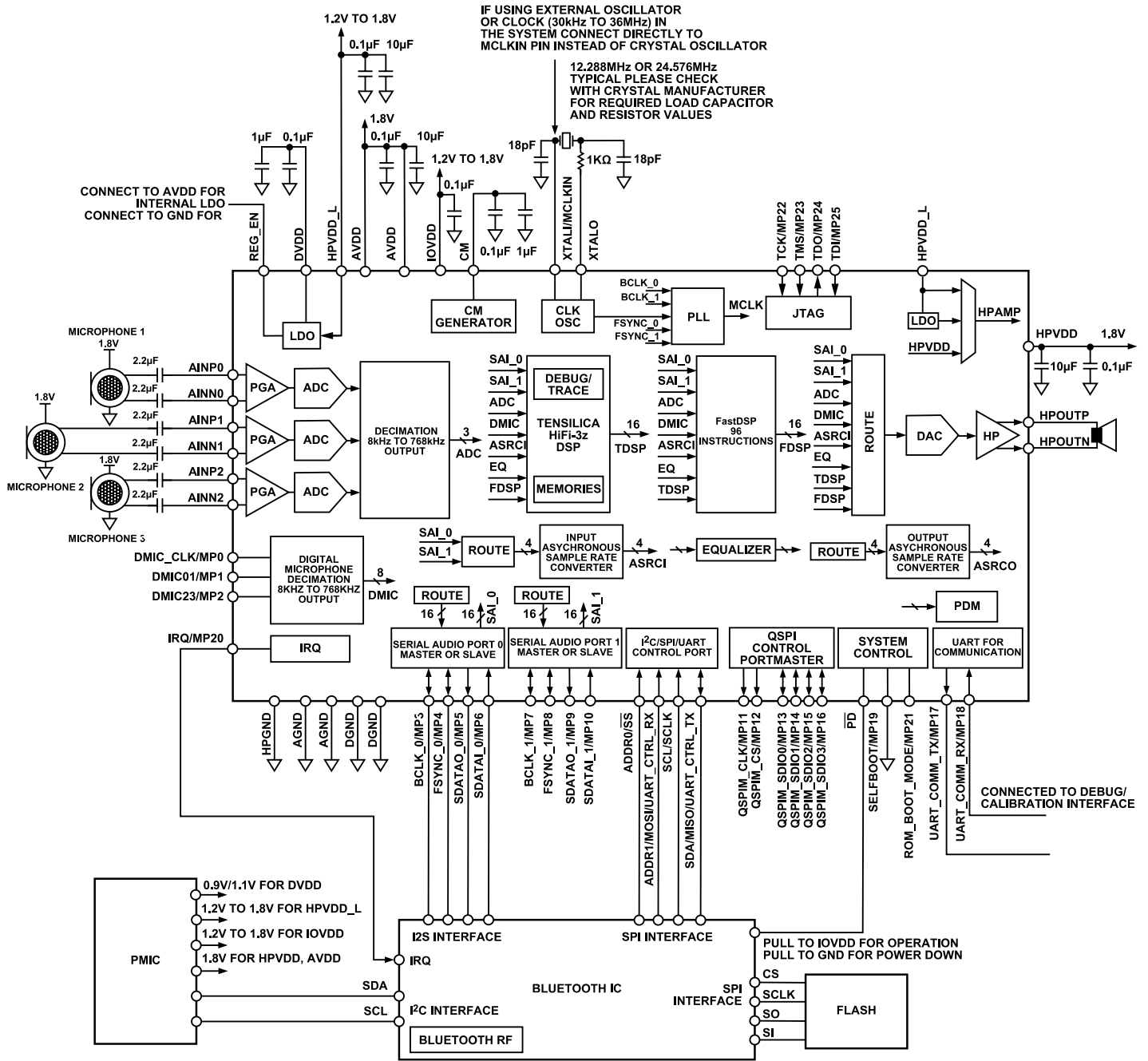

Figure 51. ADAU1860 System Block Diagram with Analog Microphones

APPLICATIONS INFORMATION

POWER SUPPLY BYPASS CAPACITORS

Bypass each analog and digital power supply pin to its nearest appropriate ground pin with a single 0.1 μF capacitor. In [Figure 52](#), VDD refers to all power supplies (DVDD, IOVDD, AVDD, HPVDD, and HPVDD_L). Keep the connections to each side of the capacitor as short as possible, and route the trace on a single layer with no vias. For maximum effectiveness, place the capacitor equidistant from the power and ground pins or slightly closer to the power pin if equidistant placement is not possible. Make thermal connections to the ground planes on the far side of the capacitor.

Bypass each supply signal on the PCB with a single bulk capacitor (10 μF to 47 μF).

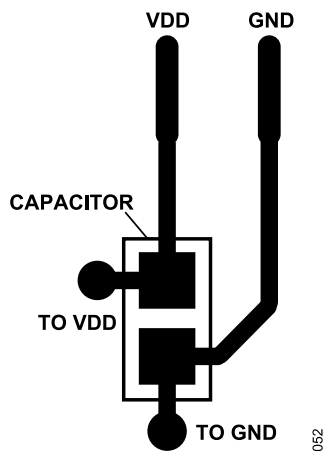

Figure 52. Recommended Power Supply Bypass Capacitor Layout

LAYOUT

The HPVDD and HPVDD_L supplies are for the headphone amplifiers. If the headphone amplifiers are enabled, the PCB traces to the HPVDD and HPVDD_L pins must be wider than the traces to the other pins to increase the current carrying capacity. Use a wider trace for the headphone output lines.

GROUNDING

Use a single ground plane in the application layout. Place components in an analog signal path away from digital signals.

OUTLINE DIMENSIONS

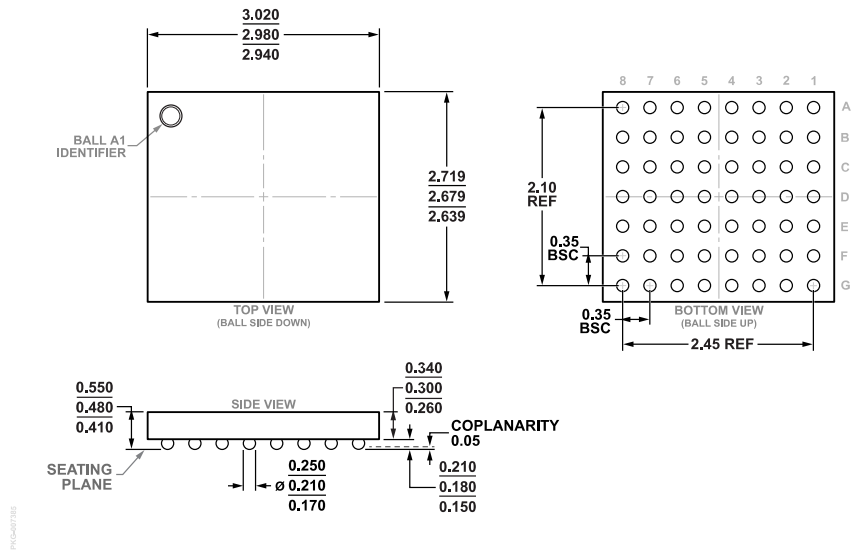

Figure 53. 56-Ball Wafer Level Chip Scale Package [WLCSP] (CB-56-6)
Dimensions shown in millimeters

Updated: July 27, 2021

ORDERING GUIDE

Model ¹	Temperature Range	Package Description	Packing Quantity	Package Option
ADAU1860BCBZRL	-40°C to +85°C	56-Ball WLCSP (2.980 mm x 2.679 mm x 0.48 mm)	Reel, 5000	CB-56-6

¹ Z = RoHS Compliant Part.

EVALUATION BOARDS

Model ¹	Description
EVAL-ADAU1860EBZ	Evaluation Board

¹ Z = RoHS Compliant Part.

I²C refers to a communications protocol originally developed by Philips Semiconductors (now NXP Semiconductors).