







Bikonkavlinen, gefasst (N-BK7), symmetrisch







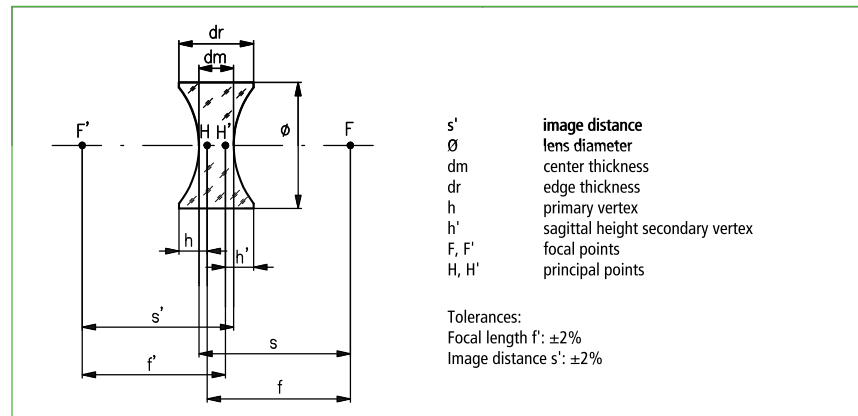
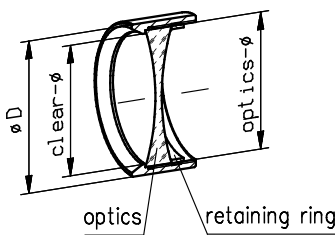



- Zwei gleiche Krümmungsradien
- Kompatibel zur Mikrobank  oder Nanobank 
- Unbeschichtet
- Toleranzen: Brennweite f' : $\pm 2\%$, Bildentfernung s' : $\pm 2\%$

Symmetric-Concave Lenses, Mounted (N-BK7)

- Two equal radii of curvature
- Mounted lenses fit to Microbench  or Nanobench 
- Surfaces uncoated
- Tolerances: Focal length f' : $\pm 2\%$, Image distance s' : $\pm 2\%$



Bikonkavlinen, gefasst (N-BK7), symmetrisch Symmetric-concave lenses, mounted (N-BK7)

Fassung	Brennweite (mm)	Optik- \varnothing (mm)	Außen- \varnothing D (mm)	Freier- \varnothing (mm)	dm (mm)	dr (mm)	h, h' (mm)	$s, s'_{588\text{ nm}}$ (mm)	$f'_{546\text{ nm}}$ (mm)	C^*	Part No.
Mount	Focal length (mm)	\varnothing optics (mm)	Outer- \varnothing D (mm)	Clear \varnothing (mm)	dm (mm)	dr (mm)	h, h' (mm)	$s, s'_{588\text{ nm}}$ (mm)	$f'_{546\text{ nm}}$ (mm)	C^*	Part No.
	-10	10	16	9	1	3.5	1.24	-10.48	-10.12	7	G052401000
	-20	12.7	16	11.5	1.5	3.5	0.98	-20.55	-19.98	11	G052402000
	-50	12.7	16	11.5	1.5	2.3	0.39	-50.88	-50.2	11	G052403000
	-100	12.7	16	11.5	1.5	1.9	0.19	-101.3	-100.4	11	G052404000
	-20	22.4	25	21.4	1.5	7.2	3.27	-20.4	-19.84	13	G063058000
	-30	22.4	25	21.4	1.5	5.6	2.07	-30.62	-30.02	13	G063059000
	-40	22.4	25	21.4	1.5	4.5	1.53	-40.75	-40.11	13	G063060000
	-50	22.4	25	21.4	1.5	3.9	1.21	-50.87	-50.2	13	G063061000
	-100	22.4	25	21.4	1.5	2.7	0.6	-101.26	-100.4	13	G063062000
	-150	22.4	25	21.4	1.5	2.3	0.4	-151.39	-150.34	13	G063063000

C^* Eine Tabelle mit weiteren Spezifikationen finden Sie zu Beginn dieses Kapitels.
Please find more specifications in the table at the beginning of this chapter.