

NOTES:

- MATERIAL:
CONNECTOR:
HOUSING - HIGH TEMPERATURE THERMOPLASTIC GLASS FILLED, UL 94V-0, BLACK
TERMINALS - COPPER ALLOY
SHELL
SILVER NICKEL, C770, THICKNESS: 0.250/0.254
- FINISH:
CONNECTOR
OPTION 1
CONTACT AREA - 0.38µm MIN GOLD OVER 2.54 µm NICKEL
SOLDER FOOT AREA - 2.54-5.09µm TIN OVER 1.27 µm NICKEL
OPTION 2
CONTACT AREA - 0.76µm MIN GOLD OVER 2.54 µm NICKEL
SOLDER FOOT AREA - 2.54-5.09µm TIN OVER 1.27 µm NICKEL
- TERMINAL SOLDER FEET TO BE COPLANAR WITHIN 0.10 MEASURED FROM FRONT HOUSING STAND OFF (DATUM C)
- DATE CODE: 4 DIGIT (3 DIGIT DAY, 1 DIGIT YEAR) CONNECTOR ONLY
- CIRCUIT IDENTIFIER: SEE APPROPRIATE INDUSTRY SPECIFICATION FOR LOCATION OF PIN 1.
- TO BE USED WITH THE FOLLOWING CABLE SERIES:
79575/74563/79576/74573/79536/74562/74586
- PACKAGED PER PACKAGING SPECIFICATION: PK-75783-001
- CONFORMS TO PRODUCT SPECIFICATION: PS-75783-001
- PROCESS PER APPLICATION SPECIFICATION: AS-75783-001
- THIS PART CONFORMS TO CLASS C REQUIREMENTS OF COSMETIC SPEC PS-45499-002

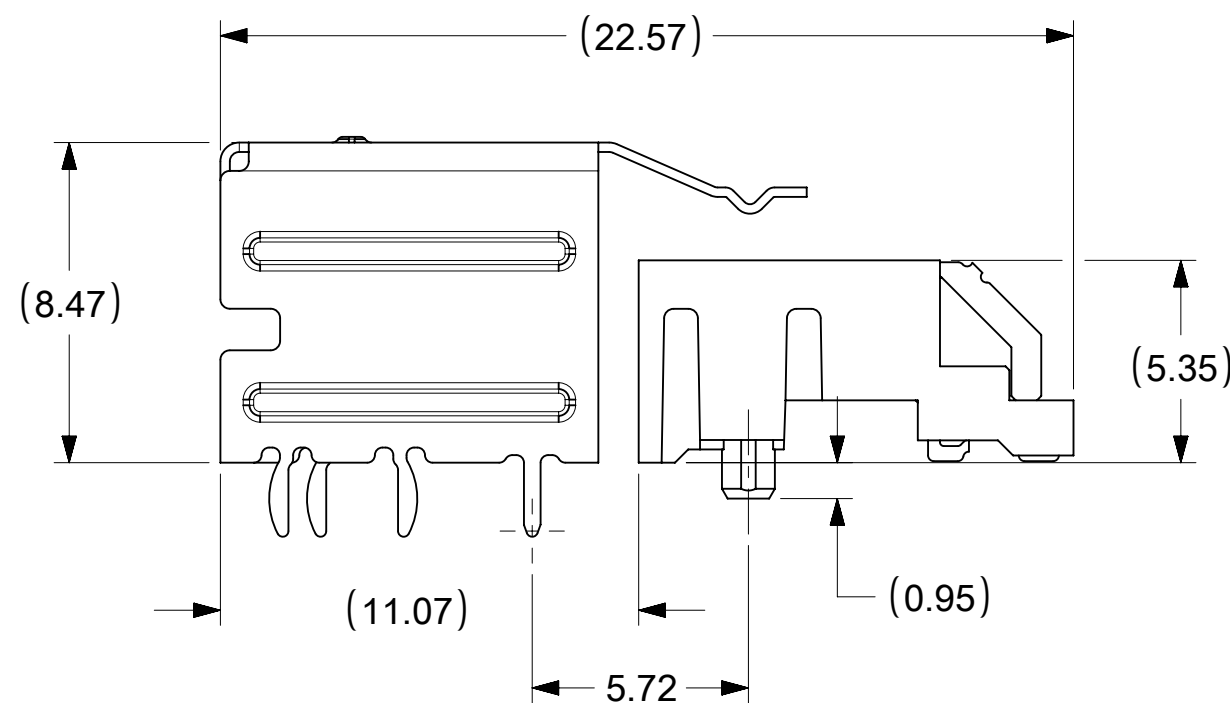
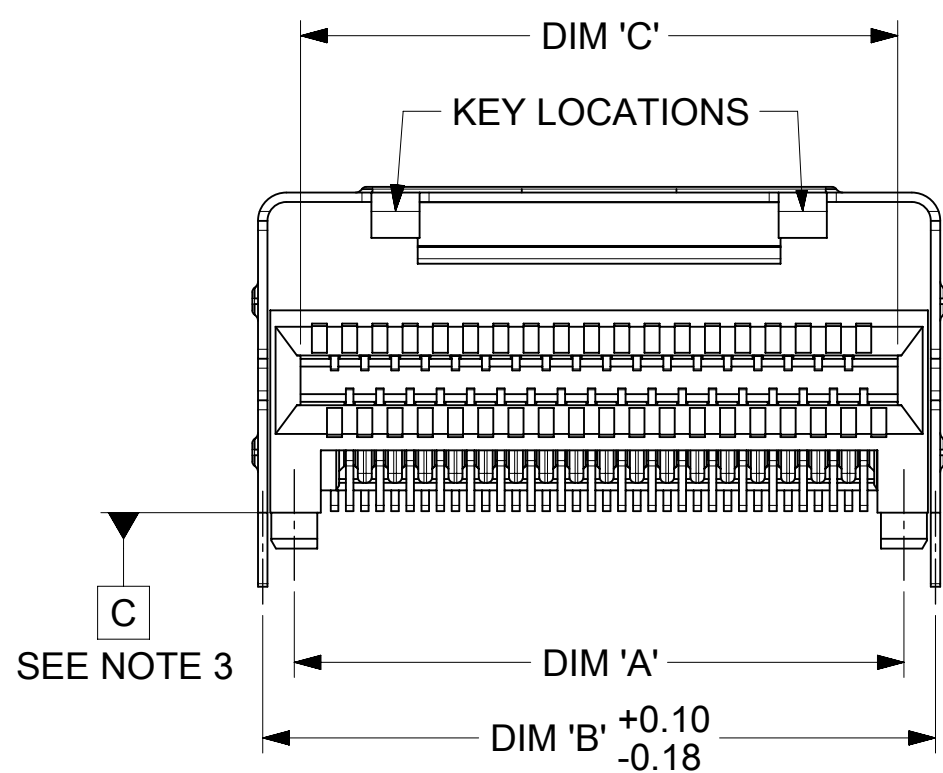

36 CIRCUIT
RETENTION FIT
SHELL OPTION SHOWN

CIRCUIT SIZE	DIM 'A'	DIM 'B'	DIM 'C'
26	12.00	13.80	11.80
36	16.00	17.80	15.80
50	21.60	23.40	21.40
68	28.80	30.60	28.60

SYMBOLS		THIS DRAWING CONTAINS INFORMATION THAT IS PROPRIETARY TO MOLEX ELECTRONIC TECHNOLOGIES, LLC AND SHOULD NOT BE USED WITHOUT WRITTEN PERMISSION	
DIMENSION UNITS	SCALE	CURRENT REV DESC: OBSOLETE PART NO	
▽ = 0	mm	5:1	molex I-PASS R/A CONNECTOR INTERNAL ASSY W/SHELL 0.8MM PITCH I/O
▽ = 0	GENERAL TOLERANCES (UNLESS SPECIFIED)		
▽ = 0	ANGULAR TOL ± 0.5°		EC NO: 696749 DRWN: MUM 2019/03/27 CHK'D: GB 2019/11/06 APPR: JKACHLIC 2022/02/23
▽ = 0	4 PLACES ±		
▽ = 0	3 PLACES ±		INITIAL REVISION: DRWN: KLANG 2005/04/15 APPR: RNELSON 2005/04/18
▽ = 0	2 PLACES ± 0.13		
▽ = 0	1 PLACE ± 0.25		PRODUCT CUSTOMER DRAWING DOCUMENT NUMBER: SD-75783-001 DOC TYPE: PSD DOC PART: 001 REVISION: F1
▽ = 0	0 PLACES ±		
▽ = 0	DRAFT WHERE APPLICABLE MUST REMAIN WITHIN DIMENSIONS		THIRD ANGLE PROJECTION DRAWING: C-SIZE SERIES: 75783
▽ = 0			
DOCUMENT STATUS: P1		RELEASE DATE: 2022/02/23 04:11:32	MATERIAL NUMBER: SEE TABLE
			CUSTOMER: GENERAL MARKET
			SHEET NUMBER: 1 OF 13

RIGHT ANGLE CONNECTOR WITH SMT SHELL PCB FOOT PRINT

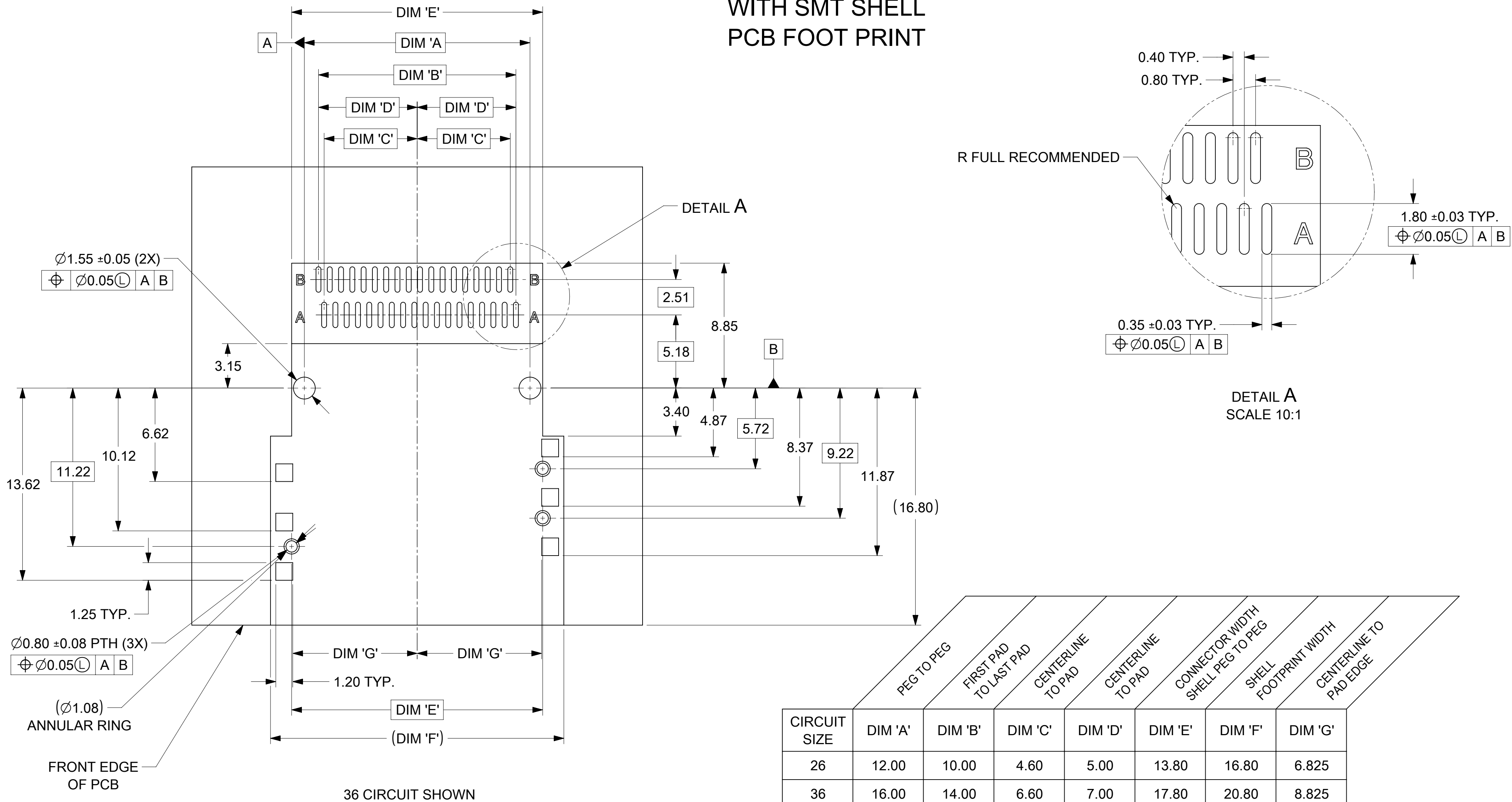

	PEG TO PEG	FIRST PAD TO LAST PAD	CENTERLINE TO PAD	CENTERLINE TO PAD	CONNECTOR WIDTH SHELL PEG TO PEG	SHELL FOOTPRINT WIDTH	CENTERLINE TO PAD EDGE
CIRCUIT SIZE	DIM 'A'	DIM 'B'	DIM 'C'	DIM 'D'	DIM 'E'	DIM 'F'	DIM 'G'
26	12.00	10.00	4.60	5.00	13.80	16.80	6.825
36	16.00	14.00	6.60	7.00	17.80	20.80	8.825
50	21.60	19.60	9.40	9.80	23.40	26.40	11.625
68	28.80	26.80	13.00	13.40	30.60	33.60	15.225

THIS DRAWING CONTAINS INFORMATION THAT IS PROPRIETARY TO MOLEX ELECTRONIC TECHNOLOGIES, LLC AND SHOULD NOT BE USED WITHOUT WRITTEN PERMISSION			
SYMBOLS	DIMENSION UNITS	SCALE	CURRENT REV DESC: OBSOLETE PART NO
▽ = 0	mm	5:1	EC NO: 696749 DRWN: MUM 2019/03/27 CHK'D: GB 2019/11/06 APPR: JKACHLIC 2022/02/23 INITIAL REVISION: DRWN: KLANG 2005/04/15 APPR: RNELSON 2005/04/18
▽ = 0	GENERAL TOLERANCES (UNLESS SPECIFIED)		
▽ = 0	ANGULAR TOL ± 0.5°		
▽ = 0	4 PLACES ±		
▽ = 0	3 PLACES ±		PRODUCT CUSTOMER DRAWING DOCUMENT NUMBER: SD-75783-001 DOC TYPE: PSD DOC PART: 001 REVISION: F1
▽ = 0	2 PLACES ± 0.13		
▽ = 0	1 PLACE ± 0.25		MATERIAL NUMBER: SEE TABLE CUSTOMER: GENERAL MARKET SHEET NUMBER: 2 OF 13
▽ = 0	0 PLACES ±		
▽ = 0	DRAFT WHERE APPLICABLE MUST REMAIN WITHIN DIMENSIONS		THIRD ANGLE PROJECTION
▽ = 0			DRAWING: C-SIZE SERIES: 75783

RIGHT ANGLE CONNECTOR WITH SHELL PCB FOOT PRINT DESCRIPTIONS



THIS DRAWING CONTAINS INFORMATION THAT IS PROPRIETARY TO MOLEX ELECTRONIC TECHNOLOGIES, LLC AND SHOULD NOT BE USED WITHOUT WRITTEN PERMISSION												
SYMBOLS	DIMENSION UNITS	SCALE	CURRENT REV DESC: OBSOLETE PART NO				molex					
▽ = 0	mm	5:1	EC NO: 696749 DRWN: MUM 2019/03/27 CHK'D: GB 2019/11/06 APPR: JKACHLIC 2022/02/23				I-PASS R/A CONNECTOR INTERNAL ASSY W/SHELL 0.8MM PITCH I/O					
▽ = 0	GENERAL TOLERANCES (UNLESS SPECIFIED)						INITIAL REVISION:			PRODUCT CUSTOMER DRAWING		
▽ = 0	ANGULAR TOL ± 0.5°									DOCUMENT NUMBER SD-75783-001		
▽ = 0	4 PLACES ±		DRWN: KLANG 2005/04/15 APPR: RNELSON 2005/04/18			MATERIAL NUMBER SEE TABLE						
▽ = 0	3 PLACES ±								SERIES 75783			CUSTOMER GENERAL MARKET
▽ = 0	2 PLACES ± 0.13		THIRD ANGLE PROJECTION 			SHEET NUMBER 3 OF 13						
▽ = 0	1 PLACE ± 0.25								DRAWING C-SIZE			
▽ = 0	0 PLACES ±		DRAFT WHERE APPLICABLE MUST REMAIN WITHIN DIMENSIONS									
▽ = 0												
▽ = 0												

MATING INTERFACE (FOR REFERENCE ONLY)

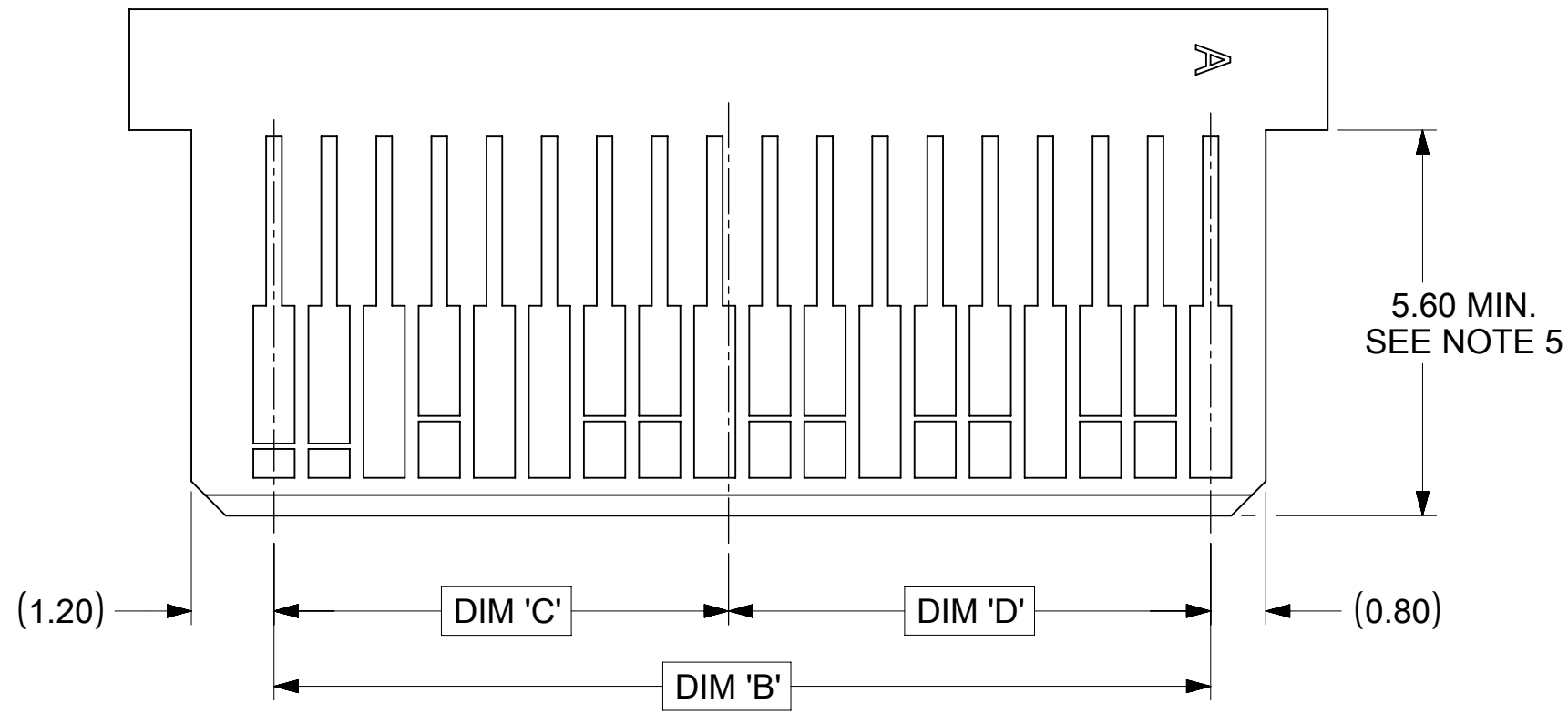
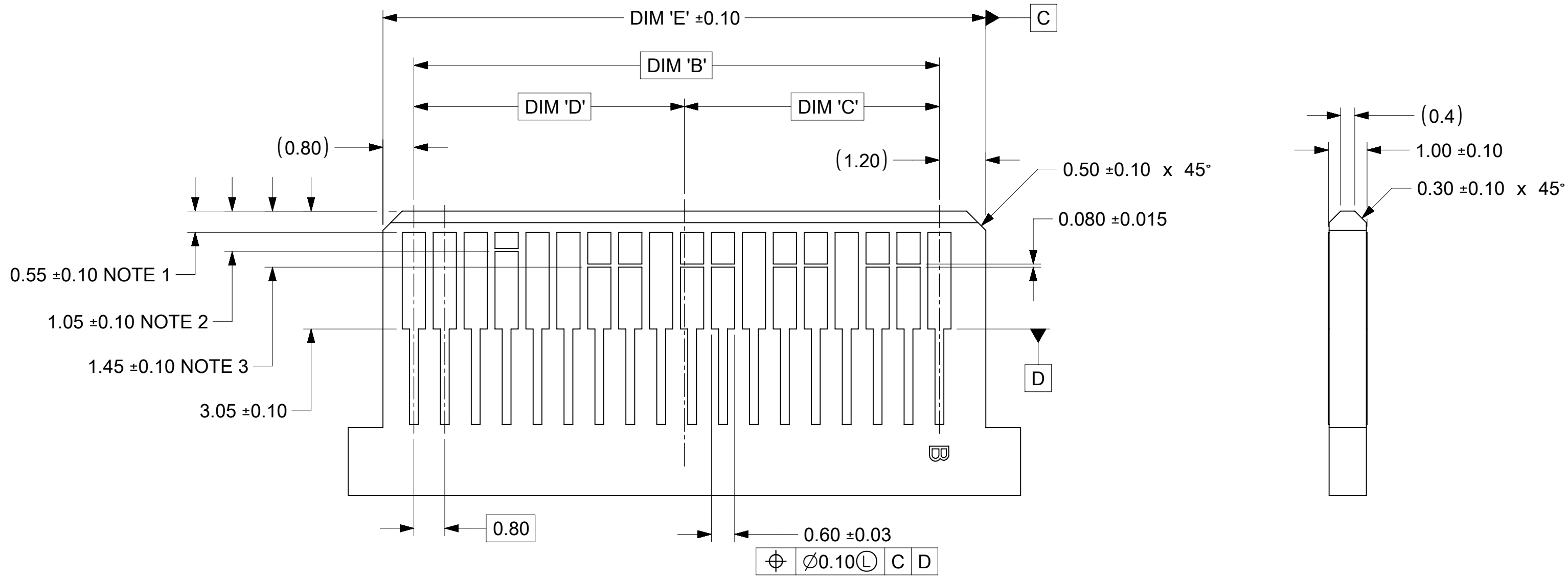

36 CIRCUIT SHOWN

NOTES:

1. PAD CONFIGURATION FOR FIRST MATE.
2. PAD CONFIGURATION FOR SECOND MATE.
3. PAD CONFIGURATION FOR THIRD MATE.
(HIGH SPEED SIGNALS)
4. FOR PIN ASSIGNMENTS AND MATING SEQUENCE (1ST, 2ND, 3RD), SEE APPLICABLE SPECIFICATION.
5. MINIMUM STEP REQUIRED IF PCB MADE WIDER THAN TONGUE.

CIRCUIT SIZE	DIM 'A'	DIM 'B'	DIM 'C'	DIM 'D'	DIM 'E'
26	13	9.60	4.60	5.00	11.60
36	18	13.60	6.60	7.00	15.60
50	25	19.20	9.40	9.80	21.20
68	34	26.40	13.00	13.40	28.40

SYMBOLS		THIS DRAWING CONTAINS INFORMATION THAT IS PROPRIETARY TO MOLEX ELECTRONIC TECHNOLOGIES, LLC AND SHOULD NOT BE USED WITHOUT WRITTEN PERMISSION	
▽ = 0	0	DIMENSION UNITS	SCALE
▽ = 0	0	mm	10:1
▽ = 0	0	CURRENT REV DESC: OBSOLETE PART NO	
▽ = 0	0	GENERAL TOLERANCES (UNLESS SPECIFIED)	
▽ = 0	0	ANGULAR TOL	± 0.5°
▽ = 0	0	4 PLACES	±
▽ = 0	0	3 PLACES	±
▽ = 0	0	2 PLACES	± 0.13
▽ = 0	0	1 PLACE	± 0.25
▽ = 0	0	0 PLACES	±
▽ = 0	0	DRAFT WHERE APPLICABLE MUST REMAIN WITHIN DIMENSIONS	
▽ = 0	0	THIRD ANGLE PROJECTION	DRAWING
▽ = 0	0	C-SIZE	SERIES
▽ = 0	0	75783	75783
EC NO: 696749		2019/03/27	
DRWN: MUM		2019/11/06	
CHK'D: GB		2022/02/23	
APPR: JKACHLIC		INITIAL REVISION:	
DRWN: KLANG		2005/04/15	
APPR: RNELSON		2005/04/18	
DOCUMENT NUMBER		DOC TYPE	DOC PART
SD-75783-001		PSD	001
MATERIAL NUMBER		CUSTOMER	SHEET NUMBER
SEE TABLE		GENERAL MARKET	4 OF 13

molex

I-PASS R/A CONNECTOR
INTERNAL ASSY W/SHELL 0.8MM PITCH I/O

PRODUCT CUSTOMER DRAWING

ASSEMBLY WITH PRE-POSITION DEVICE

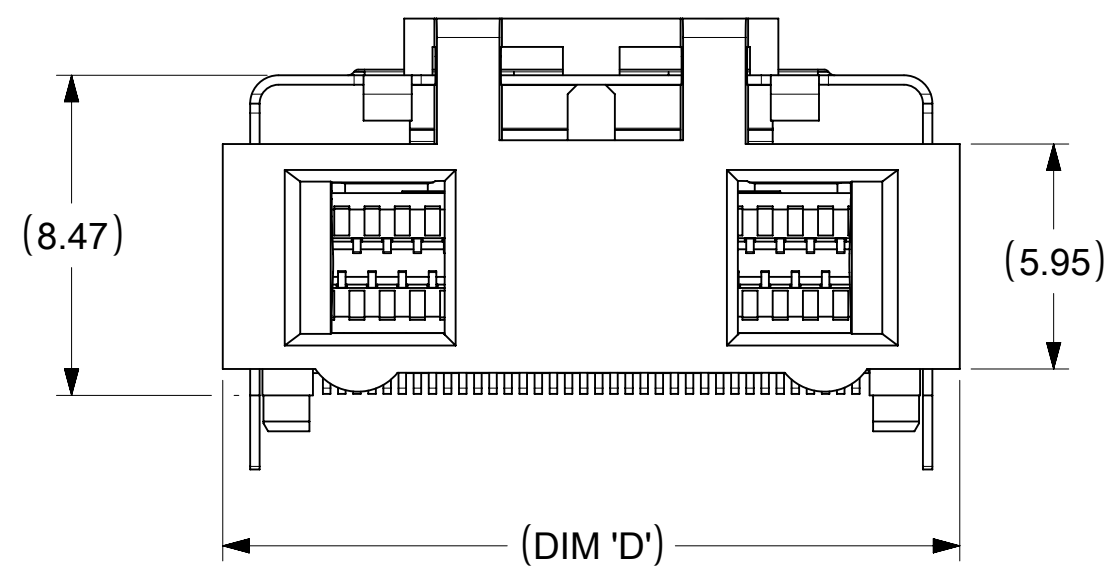

36 CIRCUIT RETENTION-FIT SHELL OPTION SHOWN

NOTES:

1. PICK AND PLACE AREA DEFINED IN APPLICATION SPECIFICATION, AS-75783-001
2. PACKAGING CONSISTS OF CONNECTOR AND SHELL WITH A PRE-POSITIONING PICK AND PLACE DEVICE THAT ARE PACKAGED IN "TAPE AND REEL" FOR ROBOTIC PICK AND PLACE.

CIRCUIT SIZE	DIM 'D'
26	15.50
36	19.50
50	25.10
68	32.30

SYMBOLS	THIS DRAWING CONTAINS INFORMATION THAT IS PROPRIETARY TO MOLEX ELECTRONIC TECHNOLOGIES, LLC AND SHOULD NOT BE USED WITHOUT WRITTEN PERMISSION		
	DIMENSION UNITS	SCALE	CURRENT REV DESC: OBSOLETE PART NO
▽ = 0	mm	5:1	molex I-PASS R/A CONNECTOR INTERNAL ASSY W/SHELL 0.8MM PITCH I/O
▽ = 0	GENERAL TOLERANCES (UNLESS SPECIFIED)		
▽ = 0	ANGULAR TOL ± 0.5°		EC NO: 696749 DRWN: MUM 2019/03/27 CHK'D: GB 2019/11/06 APPR: JKACHLIC 2022/02/23
▽ = 0	4 PLACES ±		INITIAL REVISION: DRWN: KLANG 2005/04/15 APPR: RNELSON 2005/04/18
▽ = 0	3 PLACES ±		
▽ = 0	2 PLACES ± 0.13		PRODUCT CUSTOMER DRAWING DOCUMENT NUMBER: SD-75783-001 DOC TYPE: PSD DOC PART: 001 REVISION: F1
▽ = 0	1 PLACE ± 0.25		MATERIAL NUMBER: SEE TABLE CUSTOMER: GENERAL MARKET SHEET NUMBER: 5 OF 13
▽ = 0	0 PLACES ±		
▽ = 0	DRAFT WHERE APPLICABLE MUST REMAIN WITHIN DIMENSIONS		THIRD ANGLE PROJECTION DRAWING: C-SIZE SERIES: 75783

SHELL PCB INTERFACE

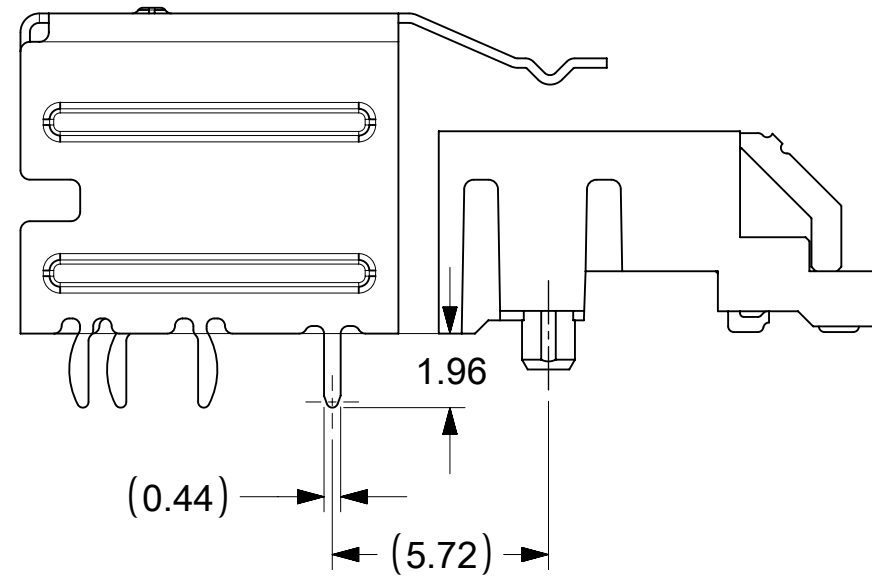
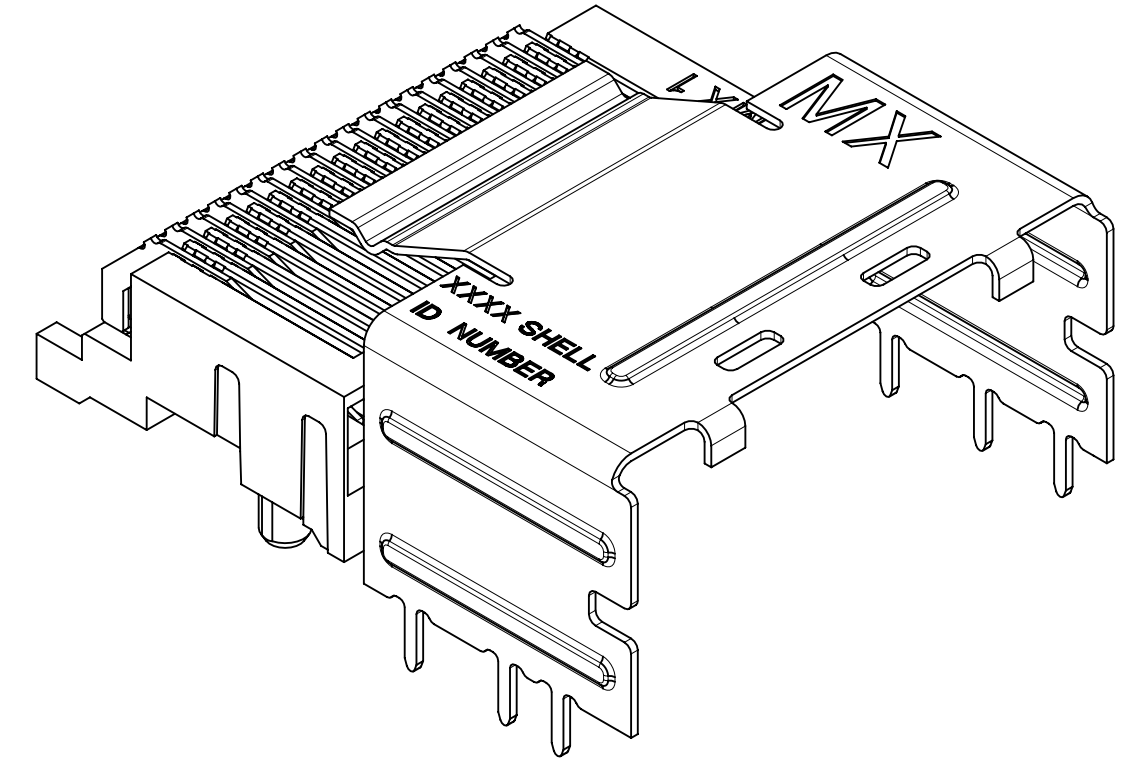

RETENTION-FIT SHELL OPTION

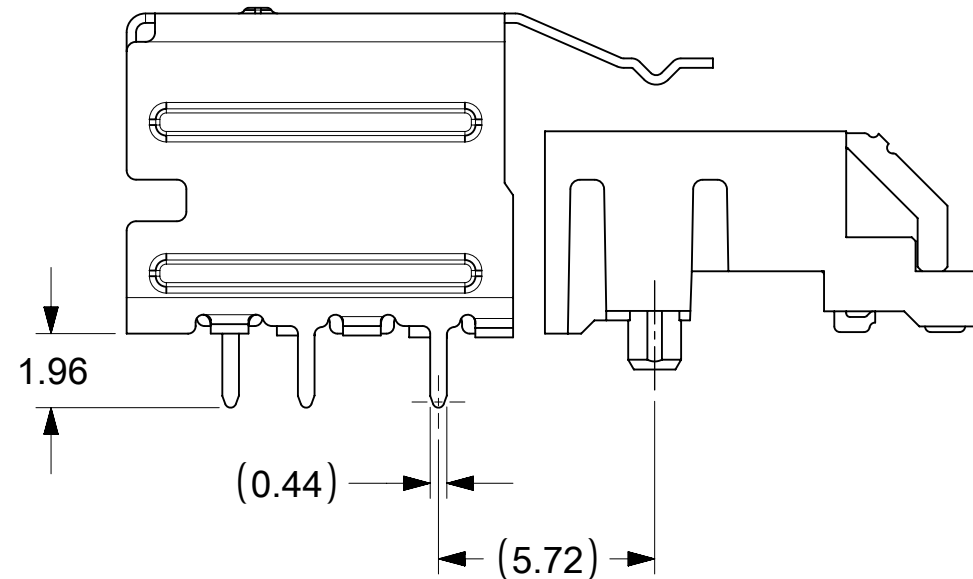

SMT SHELL OPTION

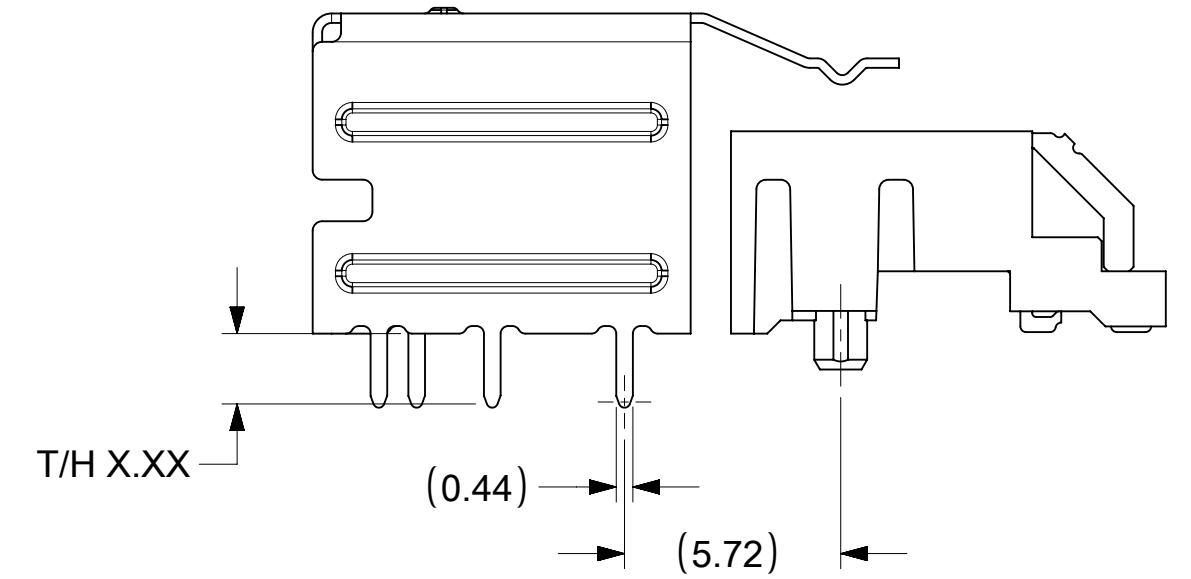

THRU-HOLE SHELL OPTION
SEE TABLE FOR LENGTH
(X.XX DENOTES TAIL LENGTH)

RECOMMENDED PCB THICKNESS FOR SPECIFIED TAIL LENGTH

TAIL LENGTH	PCB THICKNESS
1.96	1.57(.062)
2.79	2.36(.093)
3.18	2.79(.110)
3.56	3.18(.125)

NOTE:
RETENTION FIT DENOTES TAILS THAT OFFER RETENTION TO PCB DURING REFLOW PROCESS
SMT DENOTES SURFACE MOUNT TERMINATION
T/H X.XX DENOTES THRU-HOLE TAIL OF LENGTH X.XX

SYMBOLS	THIS DRAWING CONTAINS INFORMATION THAT IS PROPRIETARY TO MOLEX ELECTRONIC TECHNOLOGIES, LLC AND SHOULD NOT BE USED WITHOUT WRITTEN PERMISSION		
	DIMENSION UNITS	SCALE	CURRENT REV DESC: OBSOLETE PART NO
▽ = 0	mm	5:1	EC NO: 696749 DRWN: MUM 2019/03/27 CHK'D: GB 2019/11/06 APPR: JKACHLIC 2022/02/23
▽ = 0	GENERAL TOLERANCES (UNLESS SPECIFIED)		
▽ = 0	ANGULAR TOL ± 0.5°		INITIAL REVISION: DRWN: KLANG 2005/04/15 APPR: RNELSON 2005/04/18
▽ = 0	4 PLACES	±	
▽ = 0	3 PLACES	±	DOCUMENT NUMBER SD-75783-001
▽ = 0	2 PLACES	± 0.13	
▽ = 0	1 PLACE	± 0.25	DOC TYPE PSD
⊠ = 0	0 PLACES	±	DOC PART 001
■ = 0	DRAFT WHERE APPLICABLE MUST REMAIN WITHIN DIMENSIONS		REVISION F1
▽ = 0	THIRD ANGLE PROJECTION	DRAWING	MATERIAL NUMBER SEE TABLE
		C-SIZE	CUSTOMER GENERAL MARKET
		SERIES 75783	SHEET NUMBER 6 OF 13

molex

I-PASS R/A CONNECTOR
INTERNAL ASSY W/SHELL 0.8MM PITCH I/O

PRODUCT CUSTOMER DRAWING

KEYING OPTIONS

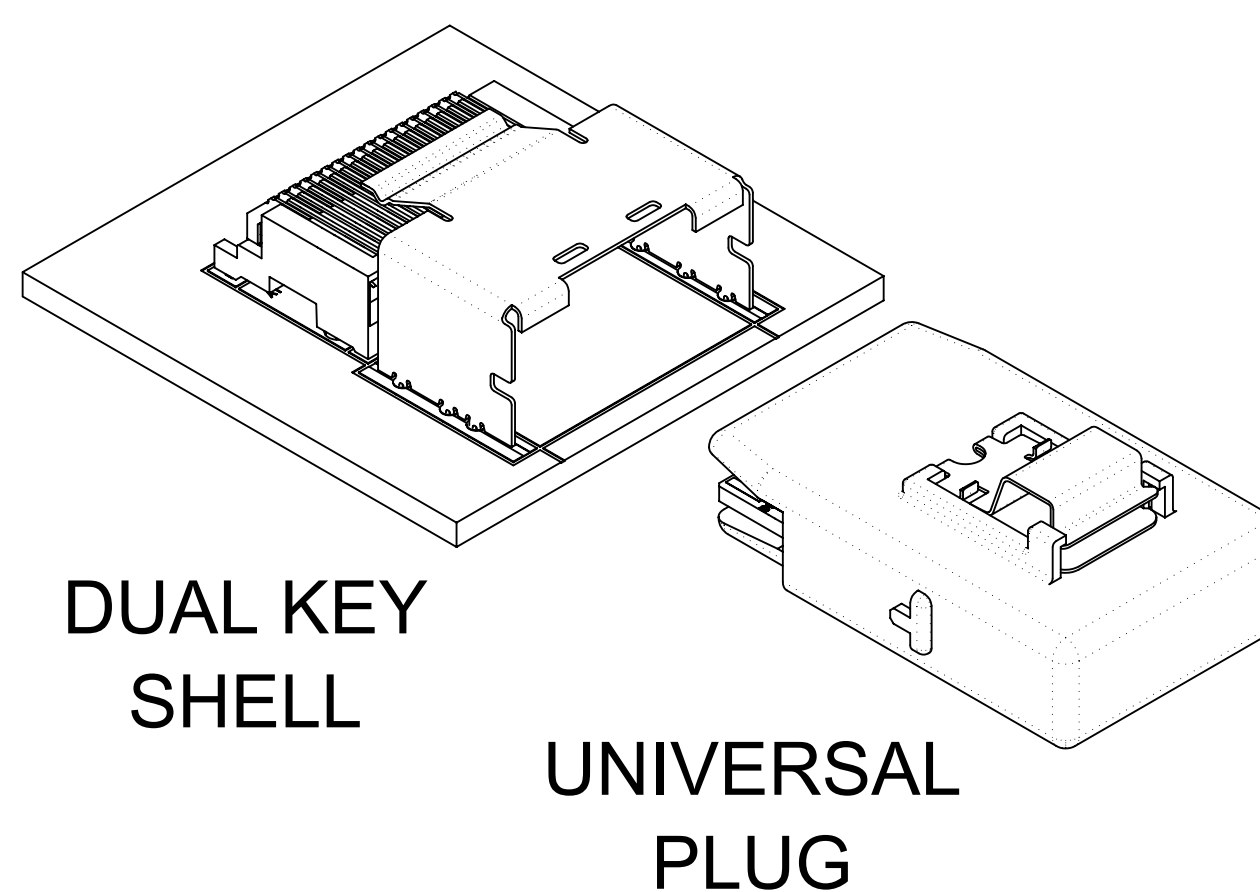
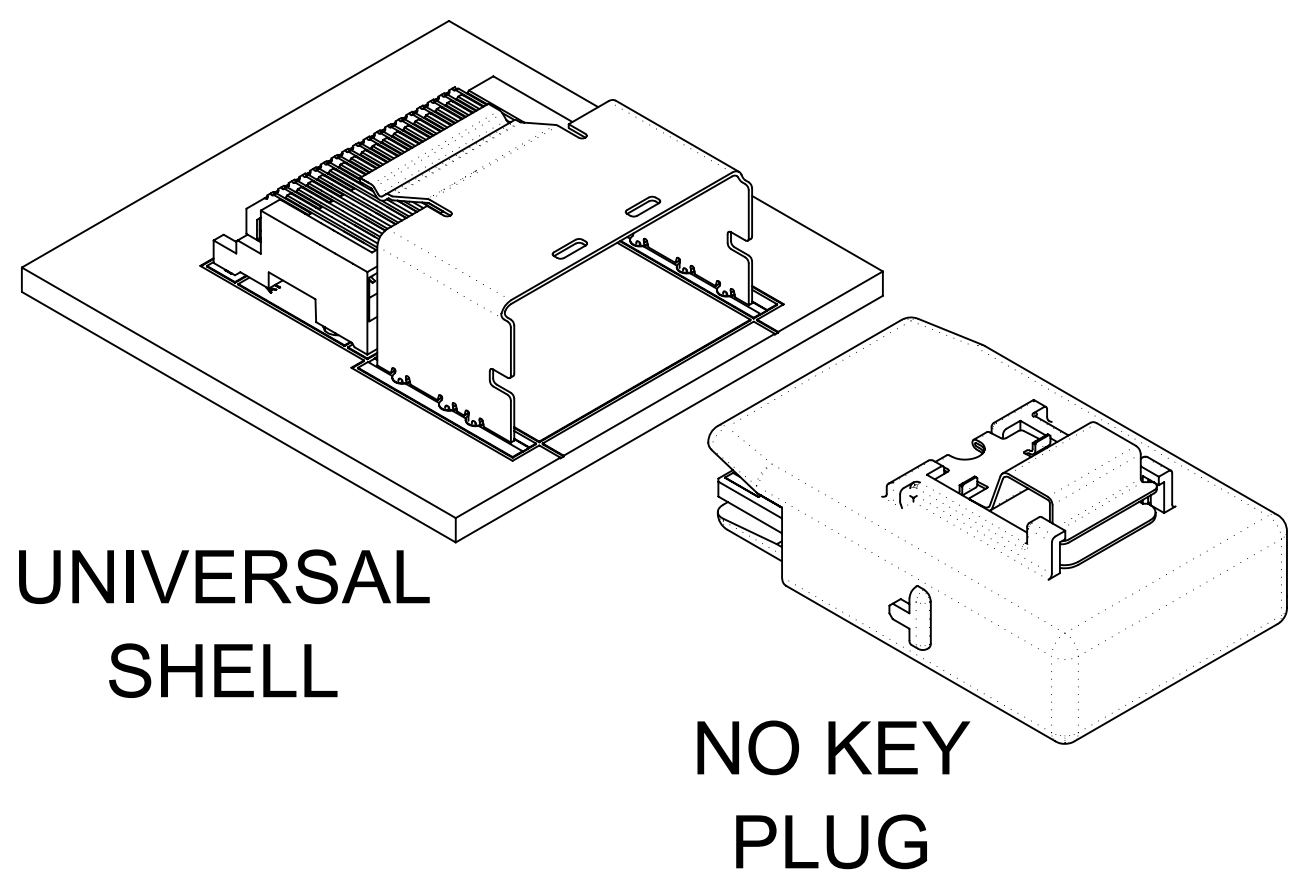
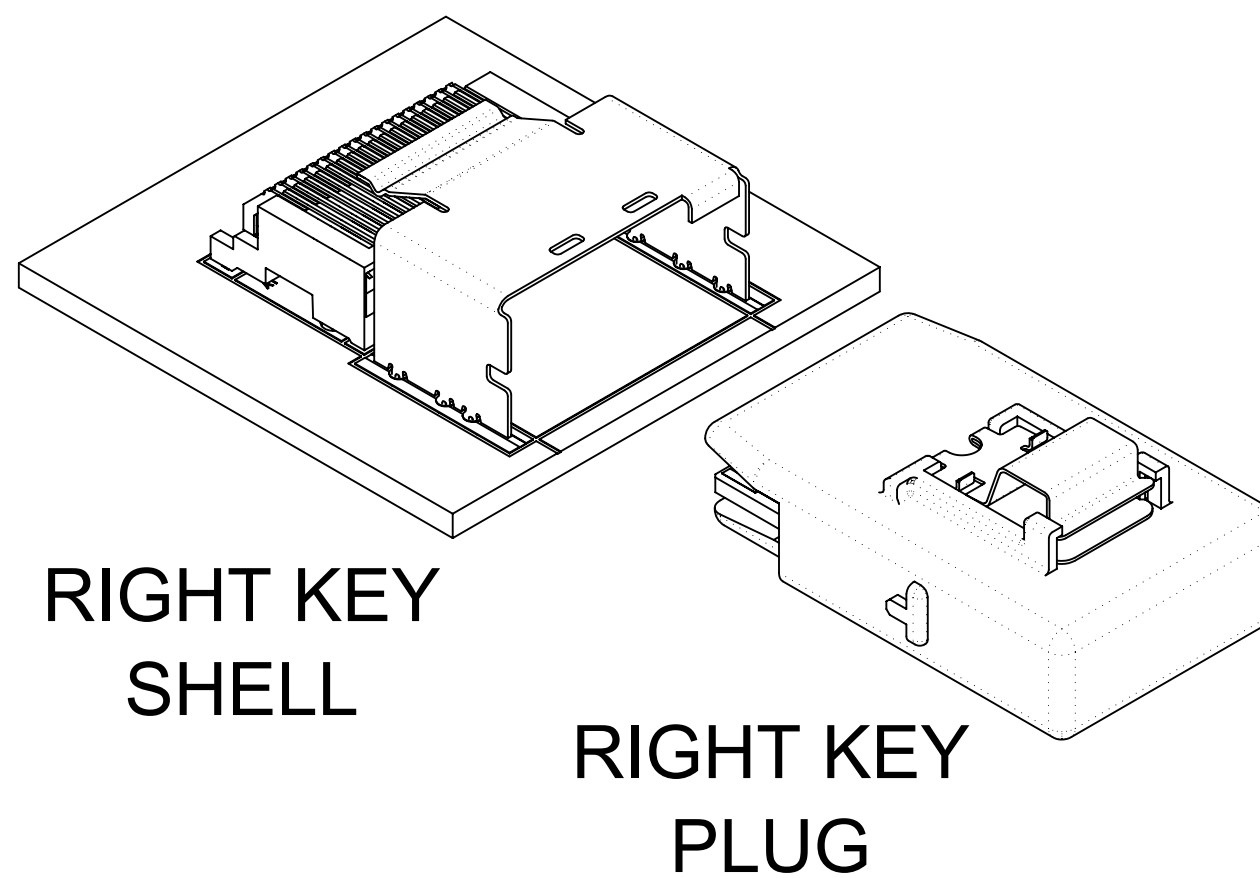
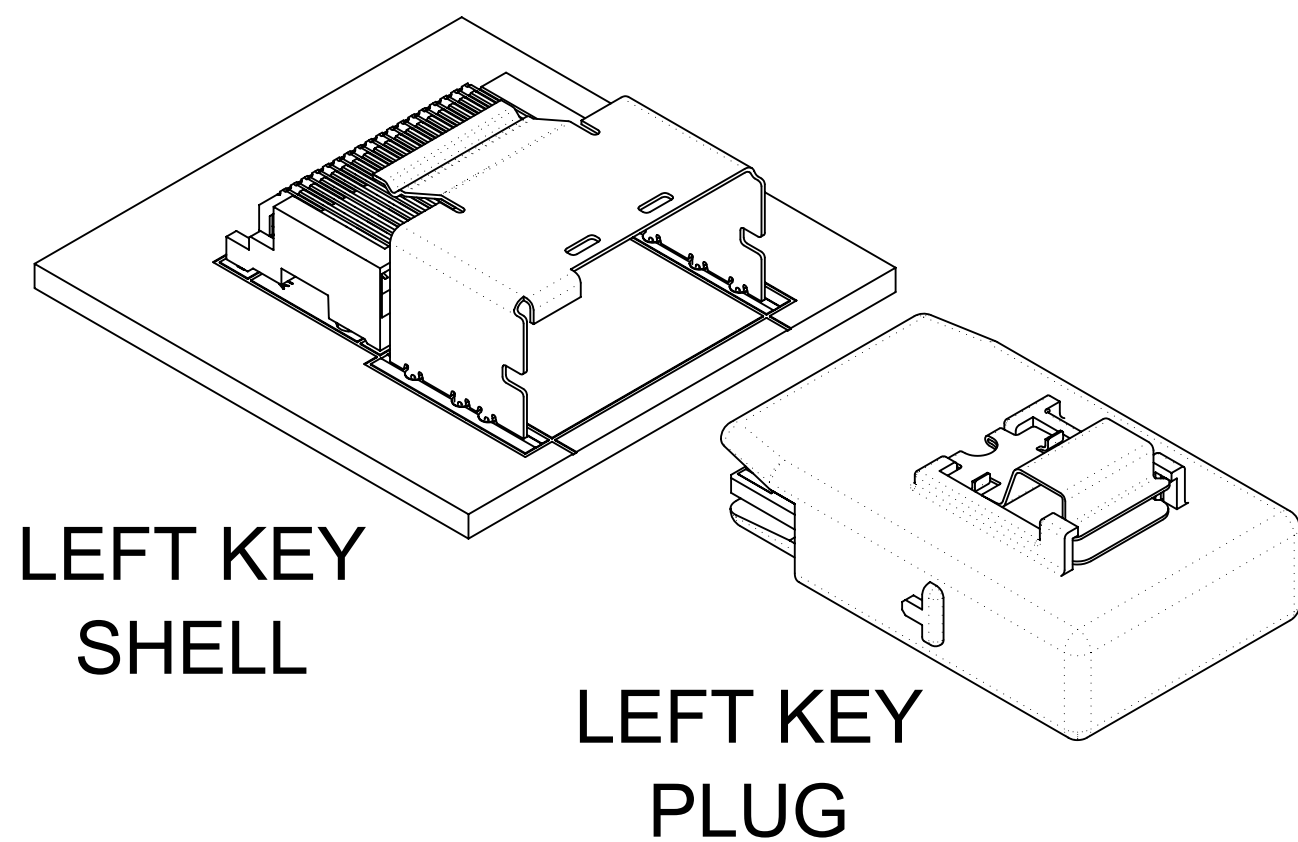

	UNIVERSAL SHELL	LEFT KEY SHELL	RIGHT KEY SHELL	DUAL KEY SHELL
NO KEY PLUG	YES	NO	NO	NO
LEFT KEY PLUG	YES	YES	NO	NO
RIGHT KEY PLUG	YES	NO	YES	NO
UNIVERSAL PLUG	YES	YES	YES	YES

THIS DRAWING CONTAINS INFORMATION THAT IS PROPRIETARY TO MOLEX ELECTRONIC TECHNOLOGIES, LLC AND SHOULD NOT BE USED WITHOUT WRITTEN PERMISSION									
SYMBOLS		DIMENSION UNITS		SCALE		CURRENT REV DESC: OBSOLETE PART NO			
▽ = 0		mm		1:1		molex I-PASS R/A CONNECTOR INTERNAL ASSY W/SHELL 0.8MM PITCH I/O PRODUCT CUSTOMER DRAWING DOCUMENT NUMBER: SD-75783-001 DOC TYPE: PSD DOC PART: 001 REVISION: F1 MATERIAL NUMBER: SEE TABLE CUSTOMER: GENERAL MARKET SHEET NUMBER: 7 OF 13			
▽ = 0		GENERAL TOLERANCES (UNLESS SPECIFIED)							
▽ = 0		ANGULAR TOL ± 0.5°							
▽ = 0		4 PLACES ±							
▽ = 0		3 PLACES ±				EC NO: 696749			
▽ = 0		2 PLACES ± 0.13				DRWN: MUM 2019/03/27			
▽ = 0		1 PLACE ± 0.25				CHK'D: GB 2019/11/06			
☒ = 0		0 PLACES ±				APPR: JKACHLIC 2022/02/23			
■ = 0		DRAFT WHERE APPLICABLE MUST REMAIN WITHIN DIMENSIONS				INITIAL REVISION:			
▽ = 0		THIRD ANGLE PROJECTION		DRAWING		SERIES		MATERIAL NUMBER	
				C-SIZE		75783		SEE TABLE	

26 CIRCUIT ITEM NUMBERS

CIRCUIT SIZE	ITEM NUMBER	PLATING OPTION	SHELL PCB OPTION	SHELL KEY OPTION
26	75783-0007	OPTION 1	RETENTION	LEFT
26	75783-0008	OPTION 1	RETENTION	RIGHT
26	75783-0009	OPTION 1	RETENTION	DUAL
26	75783-0010	OPTION 1	SMT	LEFT
26	75783-0011	OPTION 1	SMT	RIGHT
26	75783-0012	OPTION 1	SMT	DUAL
26	75783-0019	OPTION 2	RETENTION	LEFT
26	75783-0020	OPTION 2	RETENTION	RIGHT
26	75783-0021	OPTION 2	RETENTION	DUAL
26	75783-0022	OPTION 2	SMT	LEFT
26	75783-0023	OPTION 2	SMT	RIGHT
26	75783-0024	OPTION 2	SMT	DUAL
26	75783-0025	OPTION 1	RETENTION	UNIVERSAL
26	75783-0026	OPTION 1	SMT	UNIVERSAL
26	75783-0027	OPTION 2	RETENTION	UNIVERSAL
26	75783-0028	OPTION 2	SMT	UNIVERSAL
26	75783-0029	OPTION 1	T/H 1.96	LEFT
26	75783-0030	OPTION 1	T/H 1.96	RIGHT
26	75783-0031	OPTION 1	T/H 1.96	DUAL
26	75783-0032	OPTION 1	T/H 1.96	UNIVERSAL
26	75783-0033	OPTION 2	T/H 1.96	LEFT
26	75783-0034	OPTION 2	T/H 1.96	RIGHT
26	75783-0035	OPTION 2	T/H 1.96	DUAL
26	75783-0036	OPTION 2	T/H 1.96	UNIVERSAL

CIRCUIT SIZE	ITEM NUMBER	PLATING OPTION	SHELL PCB OPTION	SHELL KEY OPTION
26	75783-0037	OPTION 1	T/H 2.79	LEFT
26	75783-0038	OPTION 1	T/H 2.79	RIGHT
26	75783-0039	OPTION 1	T/H 2.79	DUAL
26	75783-0040	OPTION 1	T/H 2.79	UNIVERSAL
26	75783-0041	OPTION 2	T/H 2.79	LEFT
26	75783-0042	OPTION 2	T/H 2.79	RIGHT
26	75783-0043	OPTION 2	T/H 2.79	DUAL
26	75783-0044	OPTION 2	T/H 2.79	UNIVERSAL
26	75783-0045	OPTION 1	T/H 3.18	LEFT
26	75783-0046	OPTION 1	T/H 3.18	RIGHT
26	75783-0047	OPTION 1	T/H 3.18	DUAL
26	75783-0048	OPTION 1	T/H 3.18	UNIVERSAL
26	75783-0049	OPTION 2	T/H 3.18	LEFT
26	75783-0050	OPTION 2	T/H 3.18	RIGHT
26	75783-0051	OPTION 2	T/H 3.18	DUAL

SYMBOLS = 0 = 0 = 0 = 0 = 0 = 0 = 0 = 0 = 0	THIS DRAWING CONTAINS INFORMATION THAT IS PROPRIETARY TO MOLEX ELECTRONIC TECHNOLOGIES, LLC AND SHOULD NOT BE USED WITHOUT WRITTEN PERMISSION			
	DIMENSION UNITS	SCALE	CURRENT REV DESC: OBSOLETE PART NO	
	mm	1:1		
	GENERAL TOLERANCES (UNLESS SPECIFIED)		EC NO: 696749	
	ANGULAR TOL ± 0.5°		DRWN: MUM	2019/03/27
	4 PLACES ±	3 PLACES ±	CHK'D: GB	2019/11/06
	2 PLACES ± 0.13	1 PLACE ± 0.25	APPR: JKACHLIC	2022/02/23
	0 PLACES ±		INITIAL REVISION:	
	DRAFT WHERE APPLICABLE MUST REMAIN WITHIN DIMENSIONS		DRWN: KLANG	2005/04/15
	THIRD ANGLE PROJECTION		APPR: RNELSON	2005/04/18

I-PASS R/A CONNECTOR
INTERNAL ASSY W/SHELL 0.8MM PITCH I/O

PRODUCT CUSTOMER DRAWING

DOCUMENT NUMBER	DOC TYPE	DOC PART	REVISION
SD-75783-001	PSD	001	F1

DRAWING	SERIES	MATERIAL NUMBER	CUSTOMER	SHEET NUMBER
C-SIZE	75783	SEE TABLE	GENERAL MARKET	8 OF 13

36 CIRCUIT ITEM NUMBERS

CIRCUIT SIZE	ITEM NUMBER	PLATING OPTION	SHELL PCB OPTION	SHELL KEY OPTION
36	75783-0107	OPTION 1	RETENTION	LEFT
36	75783-0108	OPTION 1	RETENTION	RIGHT
36	75783-0109	OPTION 1	RETENTION	DUAL
36	75783-0110	OPTION 1	SMT	LEFT
36	75783-0111	OPTION 1	SMT	RIGHT
36	75783-0112	OPTION 1	SMT	DUAL
36	75783-0119	OPTION 2	RETENTION	LEFT
36	75783-0120	OPTION 2	RETENTION	RIGHT
36	75783-0121	OPTION 2	RETENTION	DUAL
36	75783-0122	OPTION 2	SMT	LEFT
36	75783-0123	OPTION 2	SMT	RIGHT
36	75783-0124	OPTION 2	SMT	DUAL
36	75783-0125	OPTION 1	RETENTION	UNIVERSAL
36	75783-0126	OPTION 1	SMT	UNIVERSAL
36	75783-0127	OPTION 2	RETENTION	UNIVERSAL
36	75783-0128	OPTION 2	SMT	UNIVERSAL
36	75783-0129	OPTION 1	T/H 1.96	LEFT
36	75783-0130	OPTION 1	T/H 1.96	RIGHT
36	75783-0131	OPTION 1	T/H 1.96	DUAL
36	75783-0132	OPTION 1	T/H 1.96	UNIVERSAL
36	75783-0133	OPTION 2	T/H 1.96	LEFT
36	75783-0134	OPTION 2	T/H 1.96	RIGHT
36	75783-0135	OPTION 2	T/H 1.96	DUAL
36	75783-0136	OPTION 2	T/H 1.96	UNIVERSAL
36	75783-0170	OPTION 1	T/H 1.40	UNIVERSAL

CIRCUIT SIZE	ITEM NUMBER	PLATING OPTION	SHELL PCB OPTION	SHELL KEY OPTION
36	75783-0137	OPTION 1	T/H 2.79	LEFT
36	75783-0138	OPTION 1	T/H 2.79	RIGHT
36	75783-0139	OPTION 1	T/H 2.79	DUAL
36	75783-0140	OPTION 1	T/H 2.79	UNIVERSAL
36	75783-0141	OPTION 2	T/H 2.79	LEFT
36	75783-0142	OPTION 2	T/H 2.79	RIGHT
36	75783-0143	OPTION 2	T/H 2.79	DUAL
36	75783-0144	OPTION 2	T/H 2.79	UNIVERSAL
36	75783-0147	OPTION 1	T/H 3.18	DUAL
36	75783-0148	OPTION 1	T/H 3.18	UNIVERSAL
36	75783-0149	OPTION 2	T/H 3.18	LEFT
36	75783-0150	OPTION 2	T/H 3.18	RIGHT
36	75783-0151	OPTION 2	T/H 3.18	DUAL
36	75783-0152	OPTION 2	T/H 3.18	UNIVERSAL
36	75783-0153	OPTION 1	T/H 3.56	LEFT
36	75783-0154	OPTION 1	T/H 3.56	RIGHT
36	75783-0155	OPTION 1	T/H 3.56	DUAL
36	75783-0156	OPTION 1	T/H 3.56	UNIVERSAL
36	75783-0157	OPTION 2	T/H 3.56	LEFT
36	75783-0158	OPTION 2	T/H 3.56	RIGHT
36	75783-0159	OPTION 2	T/H 3.56	DUAL
36	75783-0160	OPTION 2	T/H 3.56	UNIVERSAL

SYMBOLS = 0 = 0 = 0 = 0 = 0 = 0 = 0 = 0 = 0	THIS DRAWING CONTAINS INFORMATION THAT IS PROPRIETARY TO MOLEX ELECTRONIC TECHNOLOGIES, LLC AND SHOULD NOT BE USED WITHOUT WRITTEN PERMISSION DIMENSION UNITS: mm SCALE: 1:1	CURRENT REV DESC: OBSOLETE PART NO EC NO: 696749 DRWN: MUM 2019/03/27 CHK'D: GB 2019/11/06 APPR: JKACHLIC 2022/02/23	 I-PASS R/A CONNECTOR INTERNAL ASSY W/SHELL 0.8MM PITCH I/O		
	GENERAL TOLERANCES (UNLESS SPECIFIED) ANGULAR TOL ± 0.5° 4 PLACES ± 3 PLACES ± 2 PLACES ± 0.13 1 PLACE ± 0.25 0 PLACES ±	INITIAL REVISION: DRWN: KLANG 2005/04/15 APPR: RNELSON 2005/04/18			
	DRAFT WHERE APPLICABLE MUST REMAIN WITHIN DIMENSIONS THIRD ANGLE PROJECTION DRAWING SERIES: C-SIZE 75783	DOCUMENT NUMBER: SD-75783-001 DOC TYPE: PSD DOC PART: 001 REVISION: F1	MATERIAL NUMBER: SEE TABLE CUSTOMER: GENERAL MARKET SHEET NUMBER: 9 OF 13		

50 CIRCUIT ITEM NUMBERS

CIRCUIT SIZE	ITEM NUMBER	PLATING OPTION	SHELL PCB OPTION	SHELL KEY OPTION
50	75783-0207	OPTION 1	RETENTION	LEFT
50	75783-0208	OPTION 1	RETENTION	RIGHT
50	75783-0209	OPTION 1	RETENTION	DUAL
50	75783-0210	OPTION 1	SMT	LEFT
50	75783-0211	OPTION 1	SMT	RIGHT
50	75783-0212	OPTION 1	SMT	DUAL
50	75783-0219	OPTION 2	RETENTION	LEFT
50	75783-0220	OPTION 2	RETENTION	RIGHT
50	75783-0221	OPTION 2	RETENTION	DUAL
50	75783-0222	OPTION 2	SMT	LEFT
50	75783-0223	OPTION 2	SMT	RIGHT
50	75783-0224	OPTION 2	SMT	DUAL
50	75783-0225	OPTION 1	RETENTION	UNIVERSAL
50	75783-0226	OPTION 1	SMT	UNIVERSAL
50	75783-0227	OPTION 2	RETENTION	UNIVERSAL
50	75783-0228	OPTION 2	SMT	UNIVERSAL
50	75783-0229	OPTION 1	T/H 1.96	LEFT
50	75783-0230	OPTION 1	T/H 1.96	RIGHT
50	75783-0231	OPTION 1	T/H 1.96	DUAL
50	75783-0232	OPTION 1	T/H 1.96	UNIVERSAL
50	75783-0233	OPTION 2	T/H 1.96	LEFT
50	75783-0234	OPTION 2	T/H 1.96	RIGHT
50	75783-0235	OPTION 2	T/H 1.96	DUAL
50	75783-0236	OPTION 2	T/H 1.96	UNIVERSAL

CIRCUIT SIZE	ITEM NUMBER	PLATING OPTION	SHELL PCB OPTION	SHELL KEY OPTION
50	75783-0237	OPTION 1	T/H 2.79	LEFT
50	75783-0238	OPTION 1	T/H 2.79	RIGHT
50	75783-0239	OPTION 1	T/H 2.79	DUAL
50	75783-0240	OPTION 1	T/H 2.79	UNIVERSAL
50	75783-0241	OPTION 2	T/H 2.79	LEFT
50	75783-0242	OPTION 2	T/H 2.79	RIGHT
50	75783-0243	OPTION 2	T/H 2.79	DUAL
50	75783-0244	OPTION 2	T/H 2.79	UNIVERSAL
50	75783-0245	OPTION 1	T/H 3.18	LEFT
50	75783-0246	OPTION 1	T/H 3.18	RIGHT
50	75783-0247	OPTION 1	T/H 3.18	DUAL
50	75783-0248	OPTION 1	T/H 3.18	UNIVERSAL
50	75783-0249	OPTION 2	T/H 3.18	LEFT
50	75783-0250	OPTION 2	T/H 3.18	RIGHT
50	75783-0251	OPTION 2	T/H 3.18	DUAL
50	75783-0252	OPTION 2	T/H 3.18	UNIVERSAL

SYMBOLS = 0 = 0 = 0 = 0 = 0 = 0 = 0 = 0 = 0	THIS DRAWING CONTAINS INFORMATION THAT IS PROPRIETARY TO MOLEX ELECTRONIC TECHNOLOGIES, LLC AND SHOULD NOT BE USED WITHOUT WRITTEN PERMISSION			
	DIMENSION UNITS	SCALE	CURRENT REV DESC: OBSOLETE PART NO	
	mm	1:1		
	GENERAL TOLERANCES (UNLESS SPECIFIED)		EC NO: 696749	
	ANGULAR TOL ± 0.5°		DRWN: MUM	2019/03/27
	4 PLACES ±		CHK'D: GB	2019/11/06
	3 PLACES ±		APPR: JKACHLIC	2022/02/23
	2 PLACES ± 0.13		INITIAL REVISION:	
	1 PLACE ± 0.25		DRWN: KLANG	2005/04/15
	0 PLACES ±		APPR: RNELSON	2005/04/18
DRAFT WHERE APPLICABLE MUST REMAIN WITHIN DIMENSIONS		THIRD ANGLE PROJECTION	DRAWING	SERIES
			C-SIZE	75783

I-PASS R/A CONNECTOR
INTERNAL ASSY W/SHELL 0.8MM PITCH I/O

PRODUCT CUSTOMER DRAWING









DOCUMENT NUMBER	DOC TYPE	DOC PART	REVISION
SD-75783-001	PSD	001	F1

MATERIAL NUMBER	CUSTOMER	SHEET NUMBER
SEE TABLE	GENERAL MARKET	10 OF 13

68 CIRCUIT ITEM NUMBERS

CIRCUIT SIZE	ITEM NUMBER	PLATING OPTION	SHELL PCB OPTION	SHELL KEY OPTION
68	75783-0307	OPTION 1	RETENTION	LEFT
68	75783-0308	OPTION 1	RETENTION	RIGHT
68	75783-0309	OPTION 1	RETENTION	DUAL
68	75783-0310	OPTION 1	SMT	LEFT
68	75783-0311	OPTION 1	SMT	RIGHT
68	75783-0312	OPTION 1	SMT	DUAL
68	75783-0319	OPTION 2	RETENTION	LEFT
68	75783-0320	OPTION 2	RETENTION	RIGHT
68	75783-0321	OPTION 2	RETENTION	DUAL
68	75783-0322	OPTION 2	SMT	LEFT
68	75783-0323	OPTION 2	SMT	RIGHT
68	75783-0324	OPTION 2	SMT	DUAL
68	75783-0325	OPTION 1	RETENTION	UNIVERSAL
68	75783-0327	OPTION 2	RETENTION	UNIVERSAL
68	75783-0328	OPTION 2	SMT	UNIVERSAL
68	75783-0329	OPTION 1	T/H 1.96	LEFT
68	75783-0330	OPTION 1	T/H 1.96	RIGHT
68	75783-0331	OPTION 1	T/H 1.96	DUAL
68	75783-0332	OPTION 1	T/H 1.96	UNIVERSAL
68	75783-0333	OPTION 2	T/H 1.96	LEFT
68	75783-0334	OPTION 2	T/H 1.96	RIGHT
68	75783-0335	OPTION 2	T/H 1.96	DUAL
68	75783-0336	OPTION 2	T/H 1.96	UNIVERSAL

CIRCUIT SIZE	ITEM NUMBER	PLATING OPTION	SHELL PCB OPTION	SHELL KEY OPTION
68	75783-0337	OPTION 1	T/H 2.79	LEFT
68	75783-0338	OPTION 1	T/H 2.79	RIGHT
68	75783-0339	OPTION 1	T/H 2.79	DUAL
68	75783-0340	OPTION 1	T/H 2.79	UNIVERSAL
68	75783-0341	OPTION 2	T/H 2.79	LEFT
68	75783-0342	OPTION 2	T/H 2.79	RIGHT
68	75783-0343	OPTION 2	T/H 2.79	DUAL
68	75783-0344	OPTION 2	T/H 2.79	UNIVERSAL
68	75783-0345	OPTION 1	T/H 3.18	LEFT
68	75783-0346	OPTION 1	T/H 3.18	RIGHT
68	75783-0347	OPTION 1	T/H 3.18	DUAL
68	75783-0348	OPTION 1	T/H 3.18	UNIVERSAL
68	75783-0349	OPTION 2	T/H 3.18	LEFT
68	75783-0350	OPTION 2	T/H 3.18	RIGHT
68	75783-0351	OPTION 2	T/H 3.18	DUAL
68	75783-0352	OPTION 2	T/H 3.18	UNIVERSAL

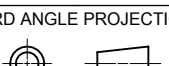
SYMBOLS  = 0  = 0  = 0  = 0  = 0  = 0  = 0  = 0	THIS DRAWING CONTAINS INFORMATION THAT IS PROPRIETARY TO MOLEX ELECTRONIC TECHNOLOGIES, LLC AND SHOULD NOT BE USED WITHOUT WRITTEN PERMISSION							
	DIMENSION UNITS	SCALE	CURRENT REV DESC: OBSOLETE PART NO					
	mm	1:1						
	GENERAL TOLERANCES (UNLESS SPECIFIED)		EC NO: 696749					
	ANGULAR TOL ± 0.5°		DRWN: MUM	2019/03/27				
	4 PLACES ±		CHK'D: GB	2019/11/06				
	3 PLACES ±		APPR: JKACHLIC	2022/02/23				
	2 PLACES ± 0.13		INITIAL REVISION:					
	1 PLACE ± 0.25		DRWN: KLANG	2005/04/15				
	0 PLACES ±		APPR: RNELSON	2005/04/18				
DRAFT WHERE APPLICABLE MUST REMAIN WITHIN DIMENSIONS		THIRD ANGLE PROJECTION	DRAWING	SERIES	DOCUMENT NUMBER	DOC TYPE	DOC PART	REVISION
			C-SIZE	75783	SD-75783-001	PSD	001	F1
					SEE TABLE	GENERAL MARKET		11 OF 13

molex

I-PASS R/A CONNECTOR
INTERNAL ASSY W/SHELL 0.8MM PITCH I/O

PRODUCT CUSTOMER DRAWING

DOCUMENT NUMBER: SD-75783-001
DOC TYPE: PSD
DOC PART: 001
REVISION: F1

MATERIAL NUMBER: SEE TABLE
CUSTOMER: GENERAL MARKET
SHEET NUMBER: 11 OF 13

RIGHT ANGLE CONNECTOR WITH RETENTION FIT & THRU-HOLE SHELL PCB FOOT PRINT

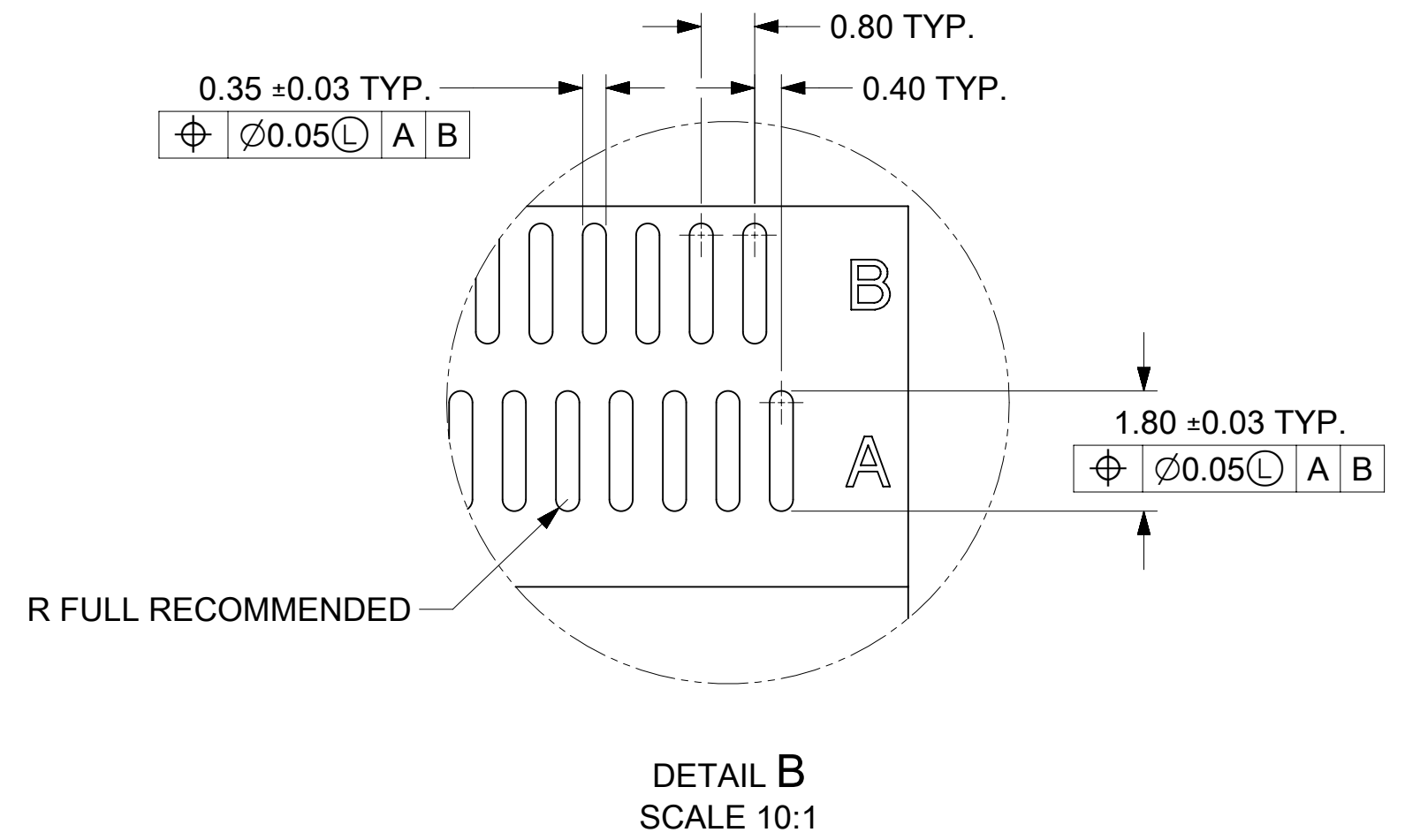
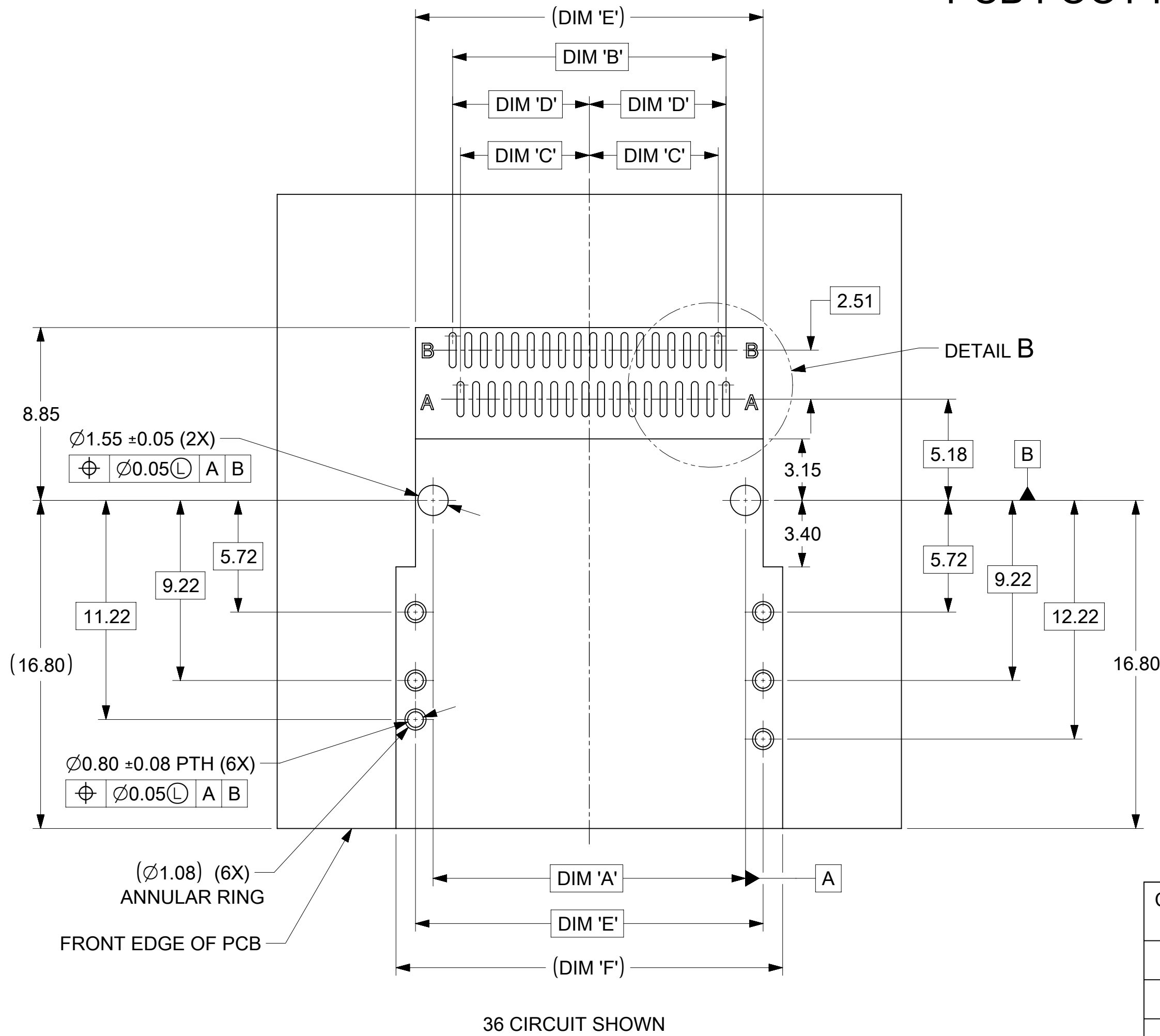









CIRCUIT SIZE	DIMENSIONS					
	PEG TO PEG	FIRST PAD TO LAST PAD	CENTERLINE TO PAD	CENTERLINE TO PAD	CONNECTOR WIDTH SHELL PEG TO PEG	SHELL FOOTPRINT WIDTH
26	DIM 'A'	DIM 'B'	DIM 'C'	DIM 'D'	DIM 'E'	DIM 'F'
36	12.00	10.00	4.60	5.00	13.80	15.80
50	16.00	14.00	6.60	7.00	17.80	19.80
68	21.60	19.60	9.40	9.80	23.40	25.40
	28.80	26.80	13.00	13.40	30.60	32.60

SYMBOLS ▽ = 0 ▽ = 0 ▽ = 0 ▽ = 0 ▽ = 0 ▽ = 0 ▽ = 0 ▽ = 0 ▽ = 0 ▽ = 0	THIS DRAWING CONTAINS INFORMATION THAT IS PROPRIETARY TO MOLEX ELECTRONIC TECHNOLOGIES, LLC AND SHOULD NOT BE USED WITHOUT WRITTEN PERMISSION DIMENSION UNITS: mm SCALE: 5:1	CURRENT REV DESC: OBSOLETE PART NO EC NO: 696749 DRWN: MUM 2019/03/27 CHK'D: GB 2019/11/06 APPR: JKACHLIC 2022/02/23			
	GENERAL TOLERANCES (UNLESS SPECIFIED) ANGULAR TOL ± 0.5° 4 PLACES ± 3 PLACES ± 2 PLACES ± 0.13 1 PLACE ± 0.25 0 PLACES ±	INITIAL REVISION: DRWN: KLANG 2005/04/15 APPR: RNELSON 2005/04/18	I-PASS R/A CONNECTOR INTERNAL ASSY W/SHELL 0.8MM PITCH I/O PRODUCT CUSTOMER DRAWING		
	DRAFT WHERE APPLICABLE MUST REMAIN WITHIN DIMENSIONS THIRD ANGLE PROJECTION DRAWING: C-SIZE SERIES: 75783	DOCUMENT NUMBER: SD-75783-001 DOC TYPE: PSD DOC PART: 001 REVISION: F1	MATERIAL NUMBER: SEE TABLE CUSTOMER: GENERAL MARKET SHEET NUMBER: 12 OF 13		

H
G
F
E
D
C
B
A

DATE	REV	DESCRIPTION
2018/03/20	F	1. REMASTERED FROM MODEL MANAGER 2. SHEET 1, NOTE 3, COPLANAR DISTANCE CHANGED FROM 0.15 TO 0.10
2019/03/28	F1	1. RECREATED IN NX 2. OBSOLETED PART NO 757830052,757830145,757830146,757830326

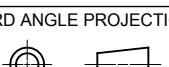
SYMBOLS  = 0  = 0  = 0  = 0  = 0  = 0  = 0  = 0  = 0	THIS DRAWING CONTAINS INFORMATION THAT IS PROPRIETARY TO MOLEX ELECTRONIC TECHNOLOGIES, LLC AND SHOULD NOT BE USED WITHOUT WRITTEN PERMISSION					
	DIMENSION UNITS	SCALE	CURRENT REV DESC: OBSOLETED PART NO			
	mm	1:1				
	GENERAL TOLERANCES (UNLESS SPECIFIED)		EC NO: 696749			
	ANGULAR TOL ± 0.5°		DRWN: MUM	2019/03/27		
	4 PLACES ±		CHK'D: GB	2019/11/06		
	3 PLACES ±		APPR: JKACHLIC	2022/02/23		
	2 PLACES ± 0.13		INITIAL REVISION:			
	1 PLACE ± 0.25		DRWN: KLANG	2005/04/15		
	0 PLACES ±		APPR: RNELSON	2005/04/18		
DRAFT WHERE APPLICABLE MUST REMAIN WITHIN DIMENSIONS	THIRD ANGLE PROJECTION	DRAWING	SERIES	MATERIAL NUMBER	CUSTOMER	SHEET NUMBER
		C-SIZE	75783	SEE TABLE	GENERAL MARKET	13 OF 13



I-PASS R/A CONNECTOR
INTERNAL ASSY W/SHELL 0.8MM PITCH I/O

PRODUCT CUSTOMER DRAWING

DOCUMENT NUMBER	DOC TYPE	DOC PART	REVISION
SD-75783-001	PSD	001	F1