

High Brightness Boost LED Driver Demoboard with 1:3000 Dimming Ratio and Excellent Current Regulation

General Description

The HV9911DB1 is an LED driver capable of driving up to 20 one-watt LEDs in series from an input of 21 - 27VDC. The demoboard uses Supertex's HV9911 in a boost topology. The converter has a very good initial regulation (+/-5%) and excellent line and load regulation over the entire input and output voltage range (<+/- 1%). The full load efficiency of the converter is typically greater than 90%.

The HV9911DB1 is also protected against open LED and output short circuit conditions. It is also protected under input undervoltage conditions by limiting the input current. It has an excellent PWM dimming response, with typical rise and fall times less than 2.0 μ s, which will allow high PWM dimming ratios.

The switching frequency of the HV9911DB1 can be synchronized to other HV9911 boards or to an external 200kHz clock by connecting the clock to the SYNC pin of the HV9911DB1.

The HV9911DB1 includes an RC filter to prevent false triggering of the short circuit protection during PWM dimming,

which was noticed with the HV9911DB1. This improvement makes the HV9911DB1 immune to turn-on current spikes in most cases. For a detailed explanation of the origin of the turn-on spike and the effect of the RC filter on the short circuit response time, please refer to the HV9911 datasheet.

Specifications

Parameter	Value
Input voltage (steady state):	21V – 27VDC
Output LED string voltage:	35V min - 80V max
Output current:	350mA +/-5%
Output current ripple:	10% typical
Switching frequency:	200kHz
Full Load efficiency:	93% (at 24V input)
Open LED protection:	Shuts down at 92V
Output short circuit protection:	Included
Input under voltage protection:	Included
PWM dimming:	1:3000 dimming ratio at 200Hz

Board Layout and Connection Diagram



Actual size: 64mm x 34.5mm

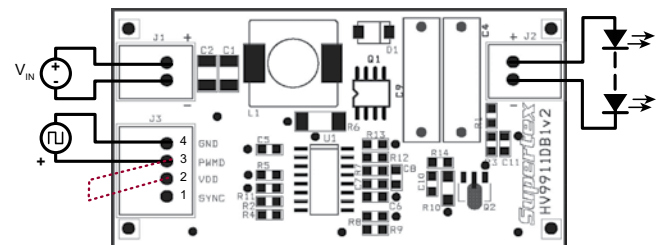

Connections:

Input - The input is connected between the terminals of connector J1 as shown in the Connection Diagram.

Output - The output is connected between the terminals of connector J2 as shown.

Enable/PWM Dimming - To just enable the board, short pins PWM and V_{DD} of connector J3 as shown by the dashed lines. To PWM dim the board, connect the external push-pull waveform source between terminals PWM and GND of connector J3 as shown by the solid lines.

SYNC - To synchronize two or more boards, connect the SYNC pins of all the boards together. To synchronize the HV9911DB1 to an external 200kHz clock, connect the clock between the SYNC and GND pins of terminal J3.

Note:

During PWM dimming, pin 2 of connector J3 should be left open. Also, the PWM signal must have the proper polarity with the positive connected to pin 3 of J3. Note that pin 4 of J3 is internally connected to the return path of the input voltage.

Testing The Demoboard:

Normal Operation: Connect the input source and the output LEDs as shown in the Connection Diagram and enable the board. The LEDs will glow with a steady intensity. Connecting an ammeter in series with the LEDs will allow measurement of the LED current. The current will be 350mA +/- 5%.

Current Regulation: With the input power to the converter disconnected, change the LED string voltage within the specifications mentioned. The current output of the HV9911DB1 will remain very steady over the entire load range. Vary the input voltage while the circuit is operational. The current will be regulated over the entire line range.

Open LED test: Connect a voltmeter across the output terminals of the HV9911DB1. Start the demoboard normally and once the LED current reaches steady state, unplug one end of the LED string from the demoboard. The output voltage will rise to about 92V and then the HV9911DB1 will shut down. To restart the converter, disconnect and reconnect the input voltage (recycle the power to the board).

Short Circuit Test: When the HV9911DB1 is operating in steady state, connect a jumper across the terminals of the LED string. Notice that the output current will immediately go to zero and the converter will shut down. To restart the HV9911DB1, recycle the input power to the demoboard.

PWM Dimming: With the input voltage to the board disconnected, apply a TTL compatible, push-pull square wave signal between PWMD and GND terminals of connector J3 as shown in the Connection Diagram. Turn the input voltage back on and adjust the duty cycle and / or frequency of the PWM dimming signal. The output current will track the PWM dimming signal. Note that although the converter operates perfectly well at 1.0kHz PWM dimming frequency, the widest PWM dimming ratio can be obtained at lower frequencies like 100 or 200Hz.

Typical Results:

1. Efficiency: The efficiency of the converter at various LED string voltages are shown in Fig.1 (measured at the nominal input voltage of 24V). Fig.2 shows the full load efficiency of the converter at varying input voltages. The minimum efficiency of 93% for the converter occurs at 21V input and full load output.

2. Current Regulation: Figs. 3 and 4 show the output current regulation vs. output voltage and input voltage respectively. The total current regulation (line and load combined) is found to be less than 1%.

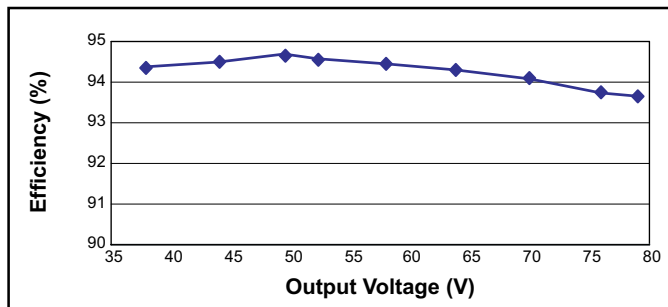

Fig. 1. Efficiency vs. Output Voltage

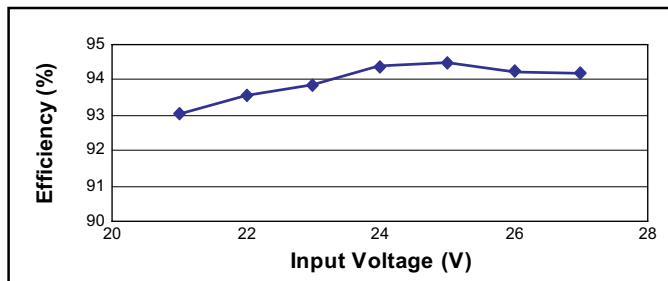

Fig. 2. Efficiency vs. Input Voltage

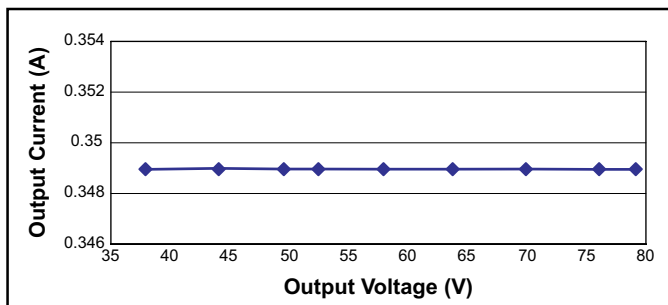

Fig. 3. Output Current vs. Output Voltage

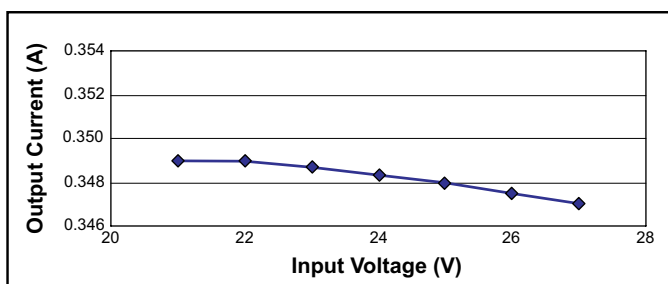

Fig. 4. Output Current vs. Input Voltage

3. Input Under Voltage Protection: Input under voltage protection is provided by limiting the input current at low input voltages. Fig. 5 shows the output and input currents at voltages less than the minimum rated voltage. The LED current will decrease as the input voltage falls and the input current limits to about 1.4A. Note that the input current limit is not a hard limit as the slope compensation added to the peak current sense signal will allow a small change in the input current with a decrease in the input voltage.

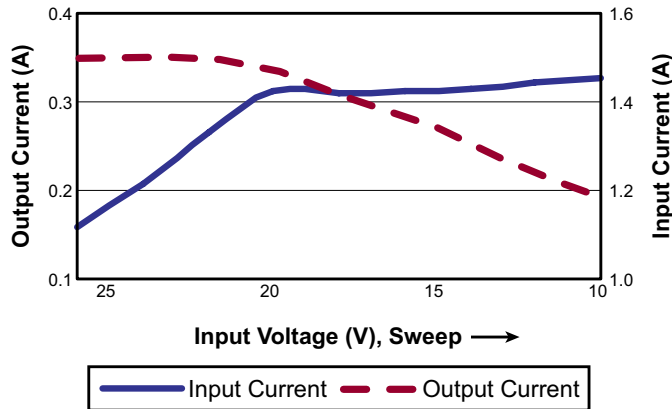

Fig. 5. Input Under Voltage Behavior

4. Open LED Protection: Open LED protection for the circuit is set at 92V. The waveforms in Fig. 6 show the output voltage, drain voltage and output current during an open LED condition. The time taken for the over voltage protection to shut the IC down will depend on the size of the output capacitor.



Fig. 6: Open LED Protection (20µs/div)

5. Output Short Circuit Protection: Fig. 7 shows the waveforms for output short circuit condition. The disconnect FET is turned off in less than 300ns. The rise in the output current will depend on the input voltage and the value of inductor L1. The same protection will also help in protecting the LEDs in case the output voltage increases beyond the LED string voltage.

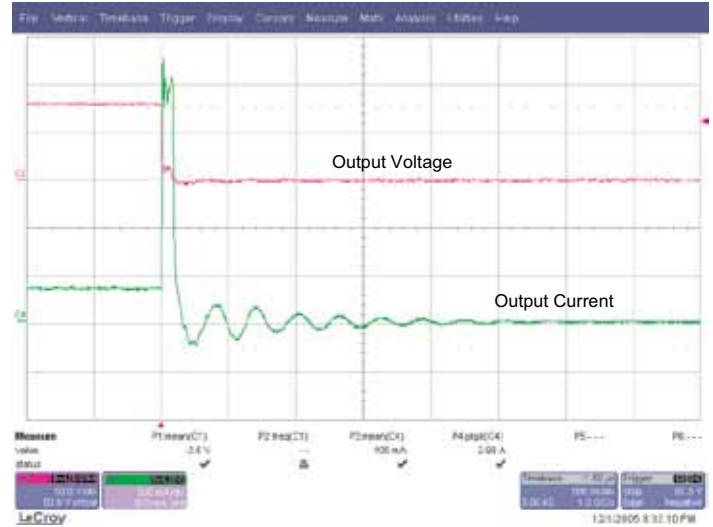

Fig. 7: Output Short Circuit Protection (500ns/div)

6. PWM Dimming: The rise and fall transitions of the LED current during PWM dimming are shown in Figs. 8 and 9, at output voltages of 80 and 40V respectively. The timescale for all waveforms is set at $5.0\mu\text{s}/\text{div}$. The rise and fall times

are less than $1.0\mu\text{s}$ in each case. Thus, a PWM dimming ratio of 1:3000 is achievable at a PWM dimming frequency of 200Hz.

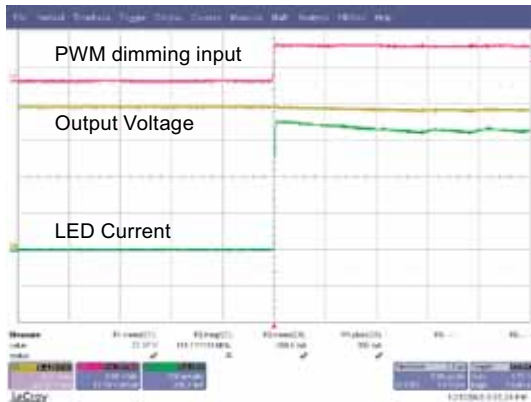

Fig. 8a: Rise time of LED Current at 80V output ($5\mu\text{s}/\text{div}$)

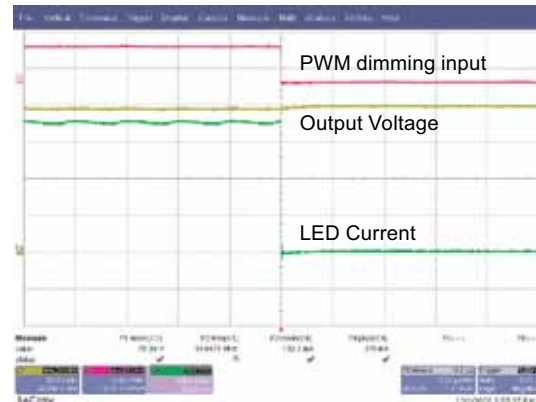

Fig. 8b: Fall time of LED Current at 80V output ($5\mu\text{s}/\text{div}$)

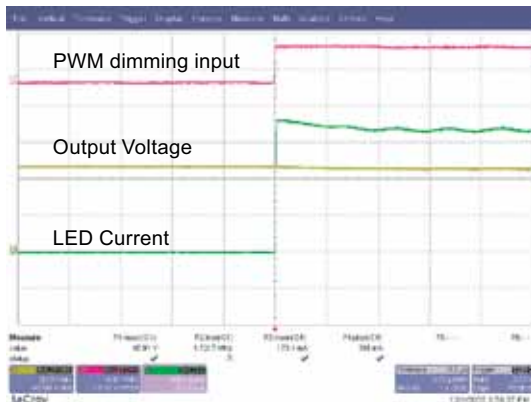

Fig. 9a: Rise time of LED Current at 40V output ($5\mu\text{s}/\text{div}$)

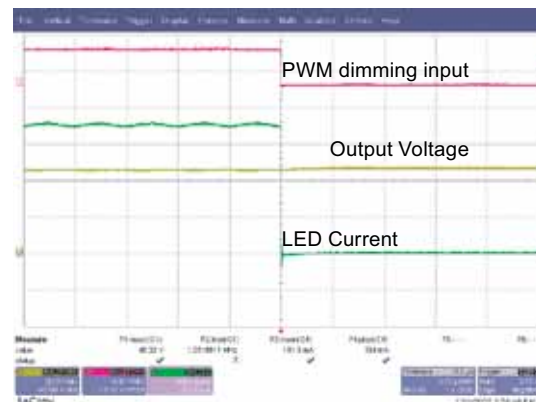
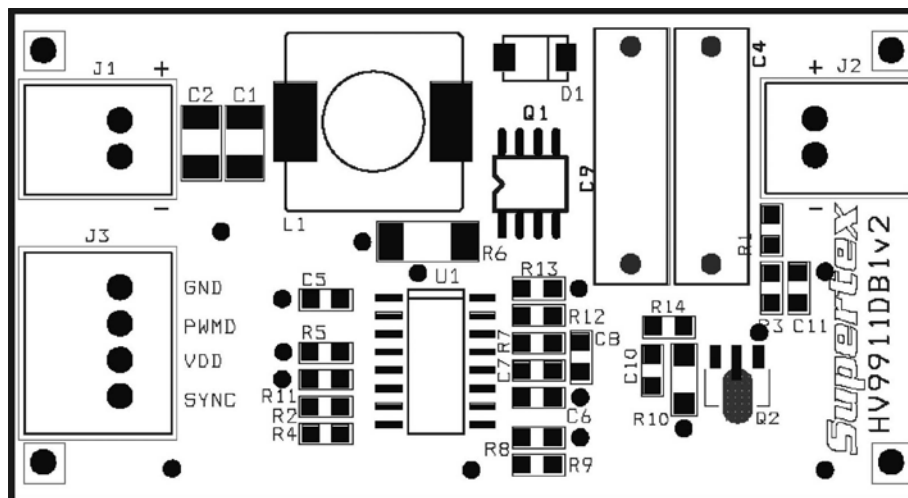
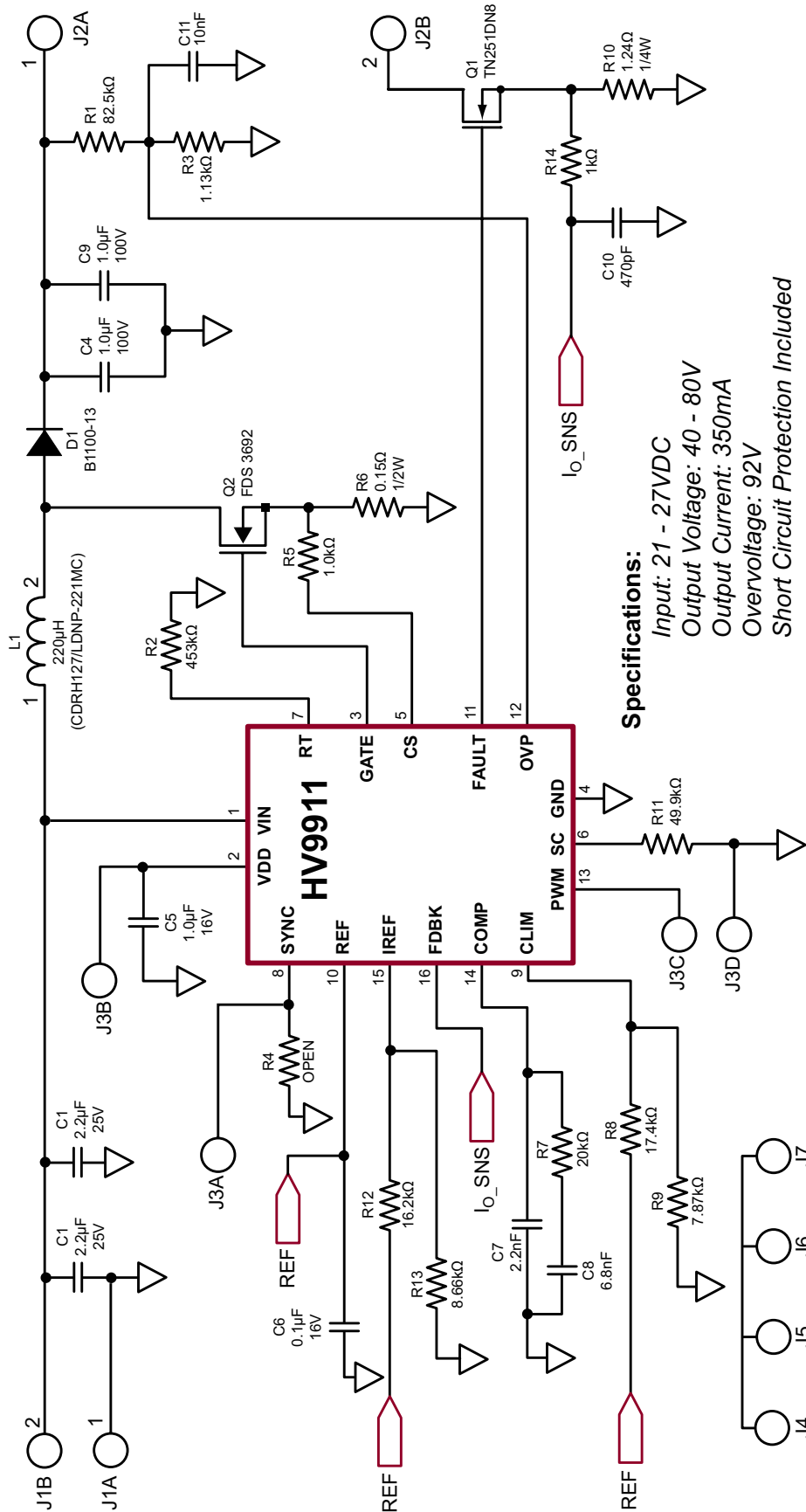

Fig. 9b: Fall time of LED Current at 40V output ($5\mu\text{s}/\text{div}$)

Silk Screen:



Circuit Schematic:



Specifications:
 Input: 21 - 27VDC
 Output Voltage: 40 - 80V
 Output Current: 350mA
 Overvoltage: 92V
 Short Circuit Protection Included

Bill of Materials

Item	Quan	Ref Des	Description	Package	Manufacturer	Manufacturer's Part Number
1	2	C1, C2	2.2 μ F, 25V, X7R ceramic chip capacitor	SMD1210	TDK Corp	C3225X7R1H225K
2	2	C4, C9	1 μ F, 100V metal polyester capacitor	Radial	EPCOS Inc	B32522C1105J
3	1	C5	1 μ F, 16V X7R ceramic chip capacitor	SMD0805	TDK Corp	C2012X7R1C105K
4	1	C6	0.1 μ F, 16V X7R ceramic chip capacitor	SMD0805	Murata	GRM219R71C104KA01D
5	1	C7	2.2nF, 5%, 50V C0G ceramic chip capacitor	SMD0805	TDK Corp	C2012C0G1H222J
6	1	C8	6.8nF, 5%, 50V C0G ceramic chip capacitor	SMD0805	TDK Corp	C2012C0G1H682J
7	1	C10	470pF, 50V X7R ceramic chip capacitor	SMD0805	AVX Corp	08055C471KAT2A
8	1	C11	10nF, 50V X7R ceramic chip capacitor	SMD0805	TDK Corp	C2012X7R1H103K
9	1	D1	100V, 1A schottky diode	SMA	Diodes Inc.	B1100-13
10	2	J1, J2	Side Entry 2-pin male header	Thru-Hole	JST Sales	S2B-EH
11	1	J3	Side Entry 4-pin male header	Thru-Hole	JST Sales	S4B-EH
12	1	L1	220 μ H, 2.0A sat, 1.5A rms inductor	SMT	Sumida	CDRH127/LDNP-221MC
13	1	Q1	100V, 4.55A N-Channel MOSFET	SO-8	Fairchild	FDS3692
14	1	Q2	100V, 1.5ohm N-Channel MOSFET	SOT-89	Supertex	TN2510N8
15	1	R1	82.5k Ω , 1%, 1/8W chip resistor	SMD0805	Yageo	RC0805FR-0782K5L
16	1	R2	453k Ω , 1%, 1/8W chip resistor	SMD0805	Yageo	RC0805FR-07453KL
17	1	R3	1.13k Ω , 1%, 1/8W chip resistor	SMD0805	Yageo	RC0805FR-071K13L
18	1	R4	open	-	-	-
19	2	R5, R14	1.0k Ω , 1%, 1/8W chip resistor	SMD0805	Yageo	RC0805FR-071KL
20	1	R6	0.15 Ω , 1%, 1/2W chip resistor	SMD2010	Vishay/ Dale	WSL2010R1500FEA
21	1	R7	20k Ω , 1%, 1/8W chip resistor	SMD0805	Yageo	RC0805FR-0720KL
22	1	R8	17.4k Ω , 1%, 1/8W chip resistor	SMD0805	Yageo	RC0805FR-0717K4L
23	1	R9	7.87k Ω , 1%, 1/8W chip resistor	SMD0805	Yageo	RC0805FR-077K87L
24	1	R10	1.24 Ω , 1%, 1/4W chip resistor	SMD1206	Yageo	RC1206FR-071R24L
25	1	R11	49.9k Ω , 1%, 1/8W chip resistor	SMD0805	Yageo	RC0805FR-0749K9L
26	1	R12	16.2k Ω , 1%, 1/8W chip resistor	SMD0805	Yageo	RC0805FR-0716K2L
27	1	R13	8.66k Ω , 1%, 1/8W chip resistor	SMD0805	Yageo	RC0805FR-078K66L
28	1	U1	Switchmode LED Driver with High Current Accuracy	SO-16	Supertex	HV9911NG-G

Supertex inc. does not recommend the use of its products in life support applications, and will not knowingly sell them for use in such applications unless it receives an adequate "product liability indemnification insurance agreement." **Supertex inc.** does not assume responsibility for use of devices described, and limits its liability to the replacement of the devices determined defective due to workmanship. No responsibility is assumed for possible omissions and inaccuracies. Circuitry and specifications are subject to change without notice. For the latest product specifications refer to the **Supertex inc.** (website: <http://www.supertex.com>)