

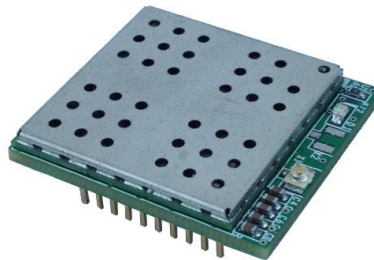

Skywire™ HSPA+ HE910 Embedded Cellular Modem Datasheet

NimbeLink Corp

Updated: September 2014



1.	INTRODUCTION	3
1.1	ORDERABLE PART NUMBERS	3
1.2	ADDITIONAL RESOURCES.....	3
1.3	PRODUCT OVERVIEW	3
1.4	BLOCK DIAGRAM.....	4
2.	TECHNICAL SPECIFICATIONS	5
2.1	ELECTRICAL SPECIFICATIONS	5
2.2	MECHANICAL SPECIFICATIONS.....	7
2.3	TEMPERATURE SPECIFICATIONS.....	7
3.	IMPORTANT DESIGN CONSIDERATIONS.....	8
3.1	ON_OFF SIGNAL.....	8
3.2	POWER SUPPLY REQUIREMENTS.....	8
4.	MOUNTING GUIDELINES.....	9
4.1	BOARD TO BOARD CONNECTORS APPROACH	9
4.2	SOLDER TO BOARD CONNECTION APPROACH.....	10
5.	ANTENNA CONSIDERATIONS	11
5.1	ANTENNA SPECIFICATIONS	11
5.2	RECOMMENDED ANTENNAS	11
6.	CERTIFICATIONS.....	12
6.1	CARRIER SPECIFIC.....	12
6.2	GEOGRAPHY SPECIFIC.....	12
7.	END PRODUCT LABELING REQUIREMENTS.....	12

1. Introduction

1.1 Orderable Part Numbers

Orderable Device	Operating Temperature	Telit Chipset	Frequencies
NL-SW-HSPAP	-40 to +85°C	HE910-NAD	800/850, AWS1700,1900
NL-SW-HSPAPG	-40 to +85°C	HE910-NAG	800/850, AWS1700,1900 & GPS
NL-SWDK-HSPAP	-40 to +85°C	HE910-NAD	800/850, AWS1700,1900
NL-SWDK-HSPAPG	-40 to +85°C	HE910-NAG	800/850, AWS1700,1900 & GPS

1.2 Additional Resources

The following documents or documentation resources are referenced within this document.

- Telit's HE910 Hardware User Guide

1.3 Product Overview

Add robust cellular connectivity to your M2M devices with scalable radio technology with Skywire line of modems including HE910 based HSPA+ solutions. Extensive experience in designing and building embedded product solutions makes the NimbeLink Skywire™ embedded cellular modem the smallest on the market. It complies with the popular XBEE interface standard and supports multiple GSM bands and fallback capability minimizing costs of hardware and network access. The module is designed for volume production and is intended for OEMs to embed into end equipment designs.

1.4 Block Diagram

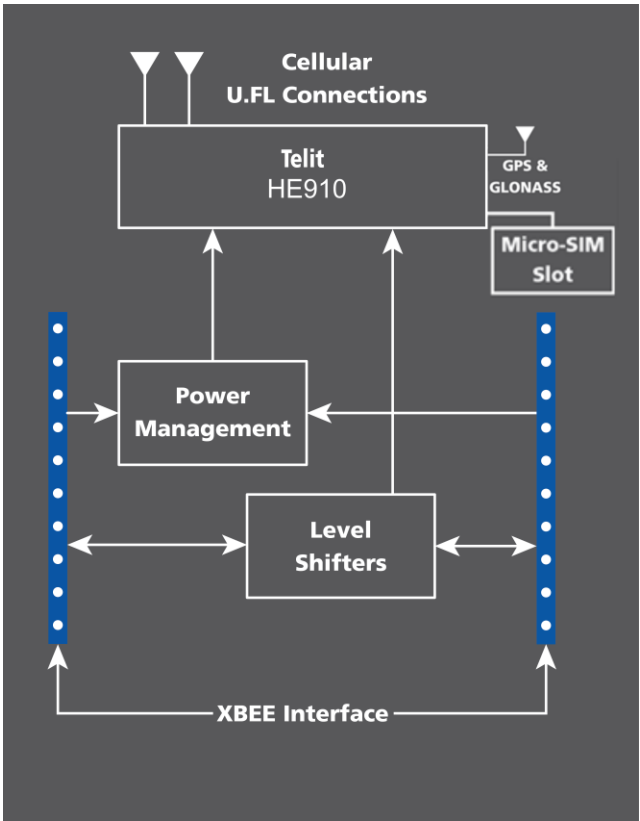

2. Technical Specifications

2.1 Electrical Specifications

2.1.1 Absolute Maximum Ratings

Parameter	Signal	Maximum Rating
Main Power Supply	VCC	4.3V
I/O Voltage Reference	VREF	5.0V

2.1.2 Recommended Ratings & Module Pin out

2.1.2.1 Connectors J1 and J2

Pin	Name	Direction	Description	Min	Typical	Max	If not used
1	VCC	Input	Main Power supply	3.5V	3.9V	4.3V	Must be implemented
2	DOUT	Output	UART data out, I/O level tied to VREF	VOL: GND to 0.55V		VOH: VREF x 0.67 to VREF	Must be implemented if USB not used, No connection
3	DIN	Input	UART data in, I/O level tied to VREF	VIL: GND to 0.15V		VIH: VREF-0.4V to VREF	Must be implemented if USB not used, No connection
4	GND	Input	Ground Pin		0		Must be implemented
5	RESET_nIN	Input	Controls HW_SHUTDOWN input on TelitLE910, tie low for 200mS and released to activate. Internally pulled up to VCC. Drive with open collector output. Assert only in an emergency as the module will not gracefully exit the cellular network when asserted.		VREF		No connection
6	VUSB	Input	Supply for USB interface	4.4V	5V	5V	No connection
7	USB_D+	I/O	USB differential Data + signal				No connection
8	USB_D-	I/O	USB differential Data - signal				No connection
9	DTR	Input	Modem Data Terminal Ready input	VIL: GND to 0.15V		VIH: VREF-0.4V to VREF	Tie to GND
10	GND	Input	Ground Pin		0		Must be implemented
11	GND	Input	Ground Pin		0		Must be implemented
12	CTS	Output	Modem Clear to Send hardware flow control output	VOL: GND to 0.55V		VOH: VREF x 0.67 to VREF	No connection

13	ON/nSLEEP	Output	Signal drives the onboard LED indicating network status. OFF = Device OFF, Fast blink = Searching for Network & Not Registered, Slow Blink = Registered with full service, Permanently on = call is active. See TelitGE910-QUAD manual for additional information.	0		1.8V	No connection
14	VREF	Input	Voltage reference for offboard I/O signals. This signal drives the input voltage side of an onboard buffer which converts all external I/O voltage from VREF range to 1.8V range to drive the onboard Telit HE910 modem module.	1.65V	1.8V or 3.3V	5.0V	Must be implemented
15	GND	Input	Ground Pin		0		Must be implemented
16	RTS	Input	Modem Request to Send hardware flow control input	VIL: GND to 0.15V		VIH: VREF-0.4V to VREF	Tie to GND
17	DIO3	I/O	Programmable GPIO_03 on TelitGE910-QUAD module	0		1.8V	No connection
18	DIO2	I/O	Programmable GPIO_02 on TelitGE910-QUAD module	0		1.8V	No connection
19	ADC1	Input	ADC_IN1 input on TelitGE910-QUAD module (10bit resolution, <1.3mV)	0		1.3V	No connection
20	ON_OFF	Input	Modem On/Off signal. Assert low for at least 5 seconds and then release to activate start sequence. Drive with open collector output. Internally pulled up to internal I/O rail with pull up. Do not use any external pull ups. Note: If you want modem to turn on automatically when power is applied, permanently tie this signal to GND.	0		1.8V	Must be implemented.

2.1.2.1 Connectors J3, X1, X2, X3

Connector Designator	Description	Connector Location
J3	Micro SIM Connector	Bottom Side of Module
X1	Primary Antenna Connection	Topside of Module
X2	Diversity Antenna Connection	Topside of Module
X3	GPS/GNSS Satellite Receiver	Bottom Side of Module

2.2 Mechanical Specifications

2.2.1 Mechanical Characteristics

Parameter	Typical	Unit
Dimensions (excluding pin height, for solder to board applications)	29.0 x 33.60 x 6.63	mm
Dimensions (including pin height, for board to board connector applications)	29.0 x 33.60 x 10.73	mm
Weight	x	Grams
Connector Insertion/Removal	hundreds	Cycles

2.2.2 Mating Connectors

Connector Designator	Manufacture	Populated on Module	Recommended Mate	Mate Manufacture
J1, J2	3M	951110-2530-AR-PR	950510-6102-AR	3M
			Acceptable alternate: NPPN101BFCN-RC	Sullins Connector Solutions
J3	Molex	786463001	Micro SIM Card	Micro SIM Card
X1, X2, X3	Hirose	U.FL-R-SMT(10)	CAB.011	Taoglas

2.3 Temperature Specifications

Parameter	Min	Typical	Max	Unit
Operating Temperature	-40	25	+85	°C
Storage Temperature	-40	25	+85	°C

3. Important Design Considerations

3.1 ON_OFF Signal

To conserve power, the Telit HE910 does not automatically start up when power is applied. The baseboard design must supply a means to assert the ON_OFF signal for the specified time (at least 5 seconds) and then released to start-up the module. After asserting the ON_OFF signal, software must wait for 10 seconds before attempting to communicate with the HE910. To make module automatically start when power is applied, tie ON/OFF signal to GND permanently. See Telit Hardware User Guide for additional details regarding the ON_OFF signal.

3.2 Power Supply Requirements

The module will regularly consume high amounts of current on the Main Power Supply (VCC), up to 2A during active transmits and receives. The baseboard power supply should be designed to support peak currents up to 2 Amps. A 100uF capacitor should be placed near the VCC pin on the module to ensure ample energy is available, with a low inductance path to the VCC pin. For example power supply designs, there are multiple references available. See the NimbeLink Skywire™ Development Kit schematic for a switching regulator example, or reference the Telit Hardware User Guide which has an example of both Linear and Switching regulator designs.

4. Mounting Guidelines

The Skywire™ embedded cellular modem supports multiple connection methods, the two primary methods are board to board connectors and soldering directly to the baseboard.

4.1 Board to Board connectors approach

The XBEE form factor calls for two, 10 pin, 2mm pitch female receptacles.

There are many connector manufactures that can be used; below is one readily available product:

Manufacture: 3M

Alternate: Sullins Connector Solutions

Part Number: 950510-6102-AR

Alternate P/N: NPPN101BFCN-RC

Typical part drawing and footprint information:

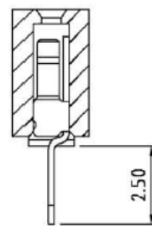
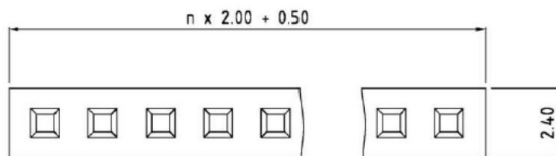
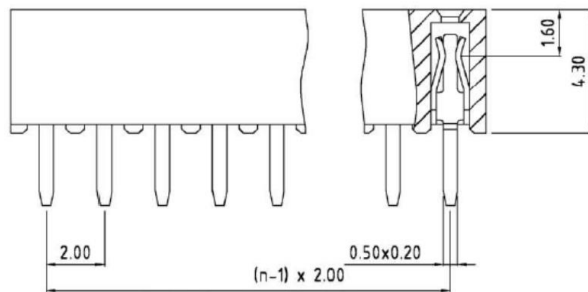

PCB Layout

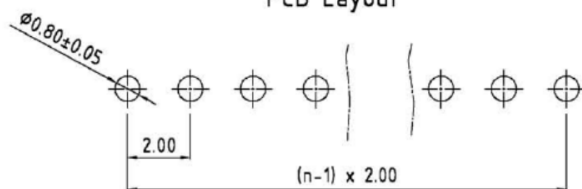

4.2 Solder to Board connection approach

The module can be soldered directly to a PCB. The PCB should be designed with two rows of ten, 0.8mm plated thru holes spaced 2mm apart. The two rows should be 22mm apart. See drawing for recommended footprint. Measurements are in millimeters. U.FL locations are marked with circles, X1 and X2 on top side of board, X3 on bottom side of board.

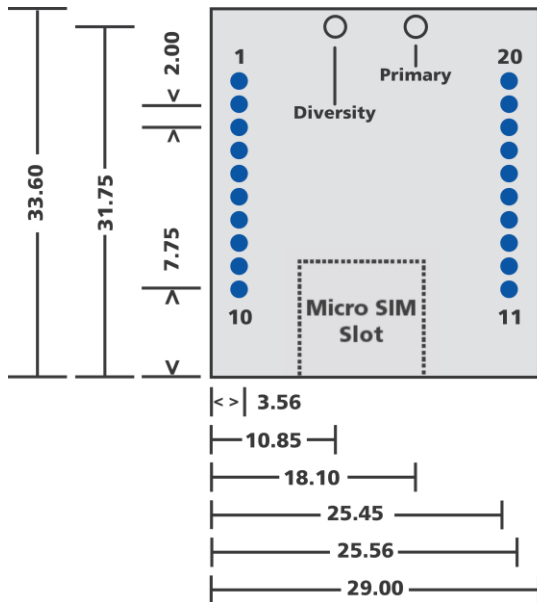

5. Antenna Considerations

5.1 Antenna Specifications - Cellular

Specifications for Primary and Diversity antennas: Parameter	Signal
Type	850/900/1800/1900Mhz
Bandwidth in GSM850	70Mhz
Bandwidth in GSM900	80Mhz
Bandwidth in DCS1800	170Mhz
Bandwidth in PCS1900	140Mhz
Max Gain in GSM850/FDD V	5.29dBi
Max Gain in PCS1900/FDD II	4.02dBi
Max Gain in AWS1700/FDD IV	6.32dBi
Impedance	50 Ohm
Input Power (Average Power)	>2 W
VSWR recommended	<2:1

Specifications for GPS: Parameter	Signal
GPS Frequency	1575.42Mhz
GPS Bandwidth	+/-1.023Mhz
Impedance	50 Ohm
HE910 includes internal LNA	
Max External LNA DC Voltage ¹	5.0V ¹

Note 1: Connector X3 provides external LNA power from module. The voltage supplied is equal to VREF.

5.2 Recommended Antennas

Type	Manufacturer	Part Number
Primary & Diversity	Taoglas ¹	TG.30.8113
Primary & GPS	Taoglas ¹	MA.301.A.AB.001

Note 1: U.FL to SMA adapter required.

For GPS/GNSS, circularly polarized antennas are desired over linear and patch topologies because they typically have 3dB improved sensitivity.

6. Certifications

6.1 Carrier Specific

Each carrier has different requirements for activating the HE910 modem on their networks. Many accept the Telit PTCRB & GCF certification to allow device on the network, however, recent carrier preferences may require the end product to go through PTCRB & GCF certification in the final enclosure, antenna, and software configuration.

6.2 Geography Specific

Federal Communications Commission (FCC47) part 22, 24

Complies with FCC47 Part 15 Class B Radiated and Conducted Emissions

7. End Product Labeling Requirements

Device Uses Approved Radio: NL-SW-HSPAP

Contains FCC ID: RI7HE910NA and IC ID: 5131A-HE910NA

This device complies with Part 15 of the FCC Rules. Operation is subject to the following two conditions: (1) This device may not cause harmful interferences, and (2) this device must accept any interference received, including interference that may cause undesired operation.