

# LTM4678 Dual 25A or Single 50A $\mu$ Module Regulator with Digital Power System Management 3x LTM4678; 150A

## DESCRIPTION

Demonstration circuit 2638A-B is a high efficiency, high density,  $\mu$ Module regulator with 4.5V to 16V input range. The output voltage is adjustable from 0.5V to 3.3V, and it can supply 150A maximum load current. The demo board has three LTM4678  $\mu$ Module regulators, and the LTM4678 is a dual 25A or single 50A step-down regulator with PMBus power system management. Please see LTM4678 data sheet for more detailed information.

DC2638A-B powers up to default settings and produce power based on configuration resistors without the need for any serial bus communication. This allows easy evaluation of the DC/DC converter. To fully explore the extensive power system management features of the part, download

the GUI software LTpowerPlay® onto your PC and use ADI's I<sup>2</sup>C/SMBus/PMBus dongle DC1613A to connect to the board. LTpowerPlay allows the user to reconfigure the part on-the-fly and store the configuration in EEPROM, view telemetry of voltage, current, temperature and fault status.

### GUI Download

The software can be downloaded from:

[LTpowerPlay](#)

For more details and instructions of LTpowerPlay, please refer to LTpowerPlay GUI for LTM4678 Quick Start Guide.

**Design files for this circuit board are available.**

All registered trademarks and trademarks are the property of their respective owners.

## PERFORMANCE SUMMARY

Specifications are at  $T_A = 25^\circ\text{C}$

PARAMETER	CONDITIONS	VALUE
Input Voltage Range		4.5V to 16V
Output Voltage, $V_{OUT}$	$V_{IN} = 4.5\text{V} - 16\text{V}$ , $I_{OUT} = 0\text{A to } 150\text{A}$	0.5V to 3.3V, Default: 1.0V
Maximum Output Current, $I_{OUT}$	$V_{IN} = 4.5\text{V} - 16\text{V}$ , $V_{OUT} = 0.5\text{V to } 3.3\text{V}$	150A
Typical Efficiency	$V_{IN} = 12\text{V}$ , $V_{OUT} = 1.0\text{V}$ , $I_{OUT} = 150\text{A}$	86% (See Figure 5)
Default Switching Frequency		350kHz

## BOARD PHOTO

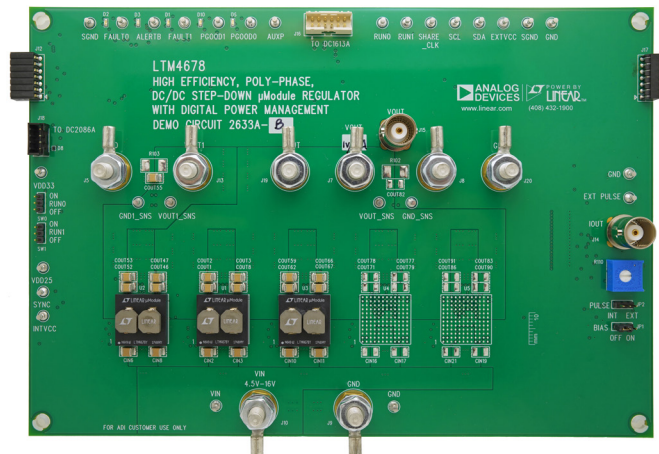

Figure 1. 3x LTM4678; 150A DC2638A-B Demo Circuit

## QUICK START PROCEDURE

Table 1. LTM4678 Demo Boards for up to 250A Point-of-Load Regulation

MAXIMUM OUTPUT CURRENT	NUMBER OF OUTPUTS	NUMBER OF LTM4678 $\mu$ Module REGULATORS ON THE BOARD	DEMO BOARD NUMBER
25A	2	1	DC2552A
50A	1	1	DC2570A
100A	1	2	DC2638A-A
150A	1	3	DC2638A-B
200A	1	4	DC2638A-C
250A	1	5	DC2638A-D

Demonstration circuit 2638A-B is easy to set up to evaluate the performance of the LTM4678EY. Refer to Figure 2 for the proper measurement equipment setup and follow the procedure below.

1. With power off, connect the input power supply to  $V_{IN}$  (4.5V–16V) and GND (input return).
2. Connect the 1.0V output load between  $V_{OUT}$  and GND (Initial load: no load).
3. Connect the DVMs to the input and output. Set default jumper position: SW0: ON; SW1: ON.
4. Turn on the input power supply and check for the proper output voltage.  $V_{OUT}$  should be  $1.0V \pm 0.5\%$ .
5. Once the proper output voltages are established, adjust the load within the operating range and observe the output voltage regulation, ripple voltage and other parameters.

6. Connect the dongle and control the output voltage from the GUI. See “LTpowerPlay GUI for the LTM4678 Quick Start Guide” for details.

Note: When measuring the output or input voltage ripple, do not use the long ground lead on the oscilloscope probe. See Figure 3 for the proper scope probe technique. Short, stiff leads need to be soldered to the (+) and (–) terminals of an output capacitor. The probe’s ground ring needs to touch the (–) lead and the probe tip needs to touch the (+) lead.

### Connecting a PC to DC2638A-B

You can use a PC to reconfigure the power management features of the LTM4678 such as: nominal  $V_{OUT}$ , margin set points, OV/UV limits, temperature fault limits, sequencing parameters, the fault log, fault responses, GPIOs and other functionalities. The DC1613A dongle may be plugged when  $V_{IN}$  is present.

**QUICK START PROCEDURE**

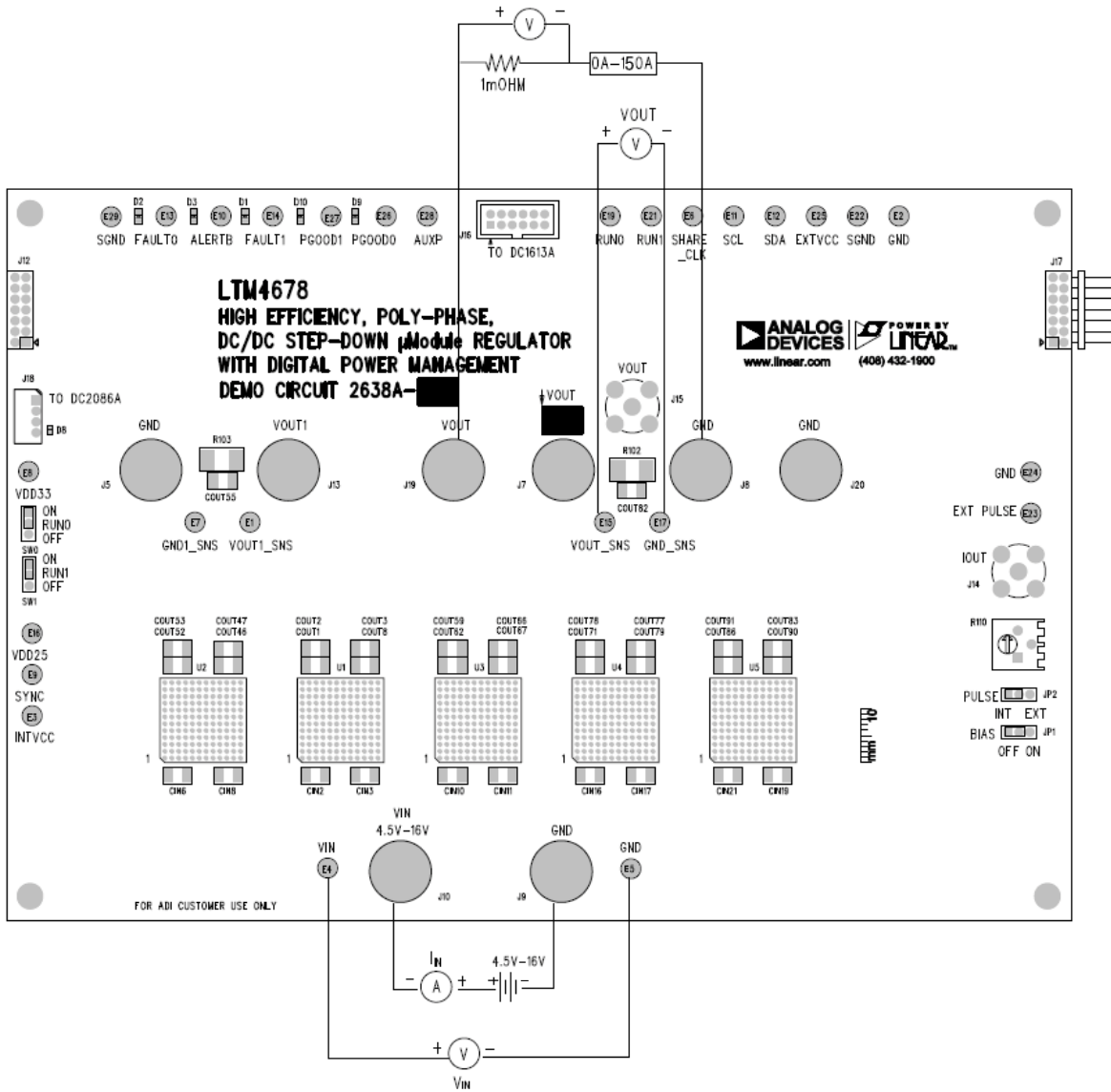

Figure 2. Proper Measurement Equipment Setup

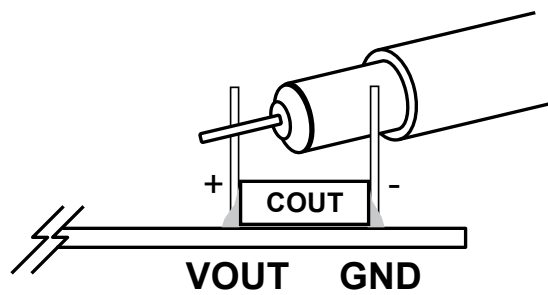

Figure 3. Measuring Output Voltage Ripple

## QUICK START PROCEDURE

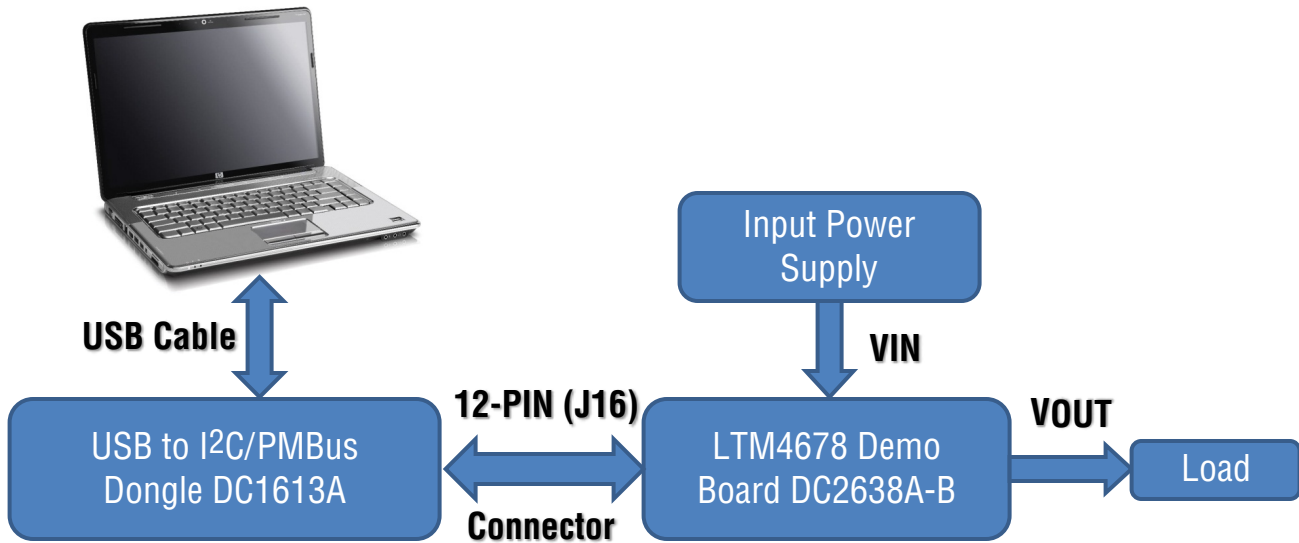

Figure 4. Demo Setup with PC

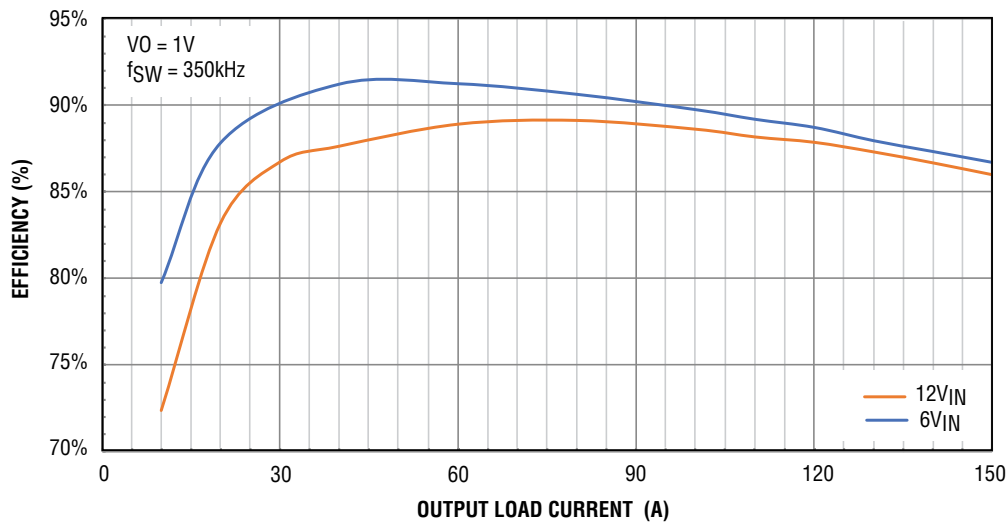
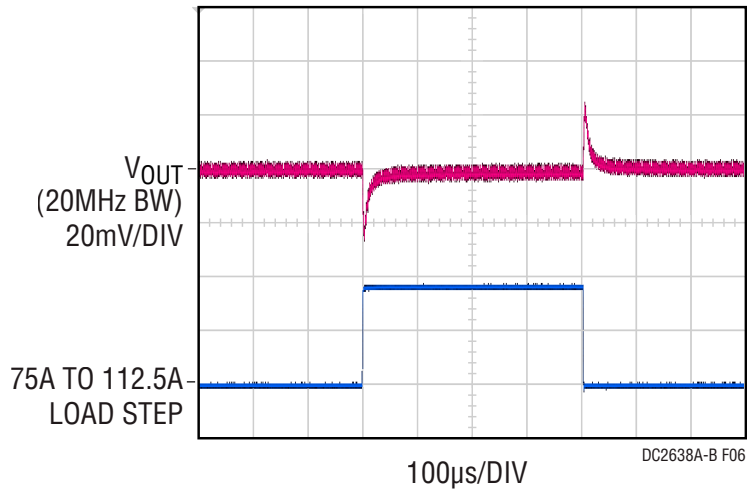
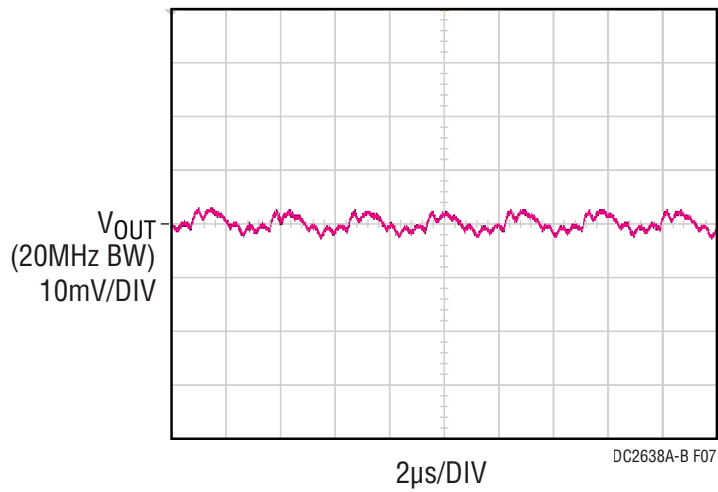

Figure 5. Efficiency vs Load Current

**QUICK START PROCEDURE**



**Figure 6. Output Voltage  $V_{OUT}$  vs Load Current @  $V_{IN} = 12V$ ,  $V_{OUT} = 1V$ ,  $f_{SW} = 350kHz$**



**Figure 7. Output Voltage Ripple @  $V_{IN} = 12V$ ,  $V_{OUT} = 1V$ ,  $I_{OUT} = 150A$ ,  $f_{SW} = 350kHz$**

## QUICK START PROCEDURE

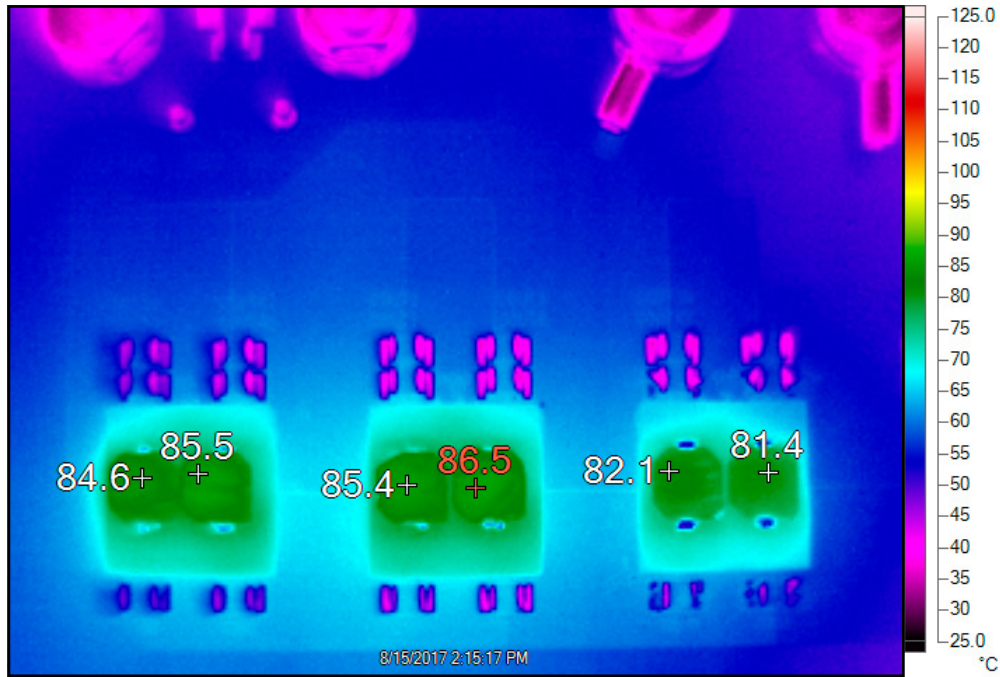

Figure 8. Thermal @  $V_{IN} = 12V$ ,  $V_{OUT} = 1.0V$ ,  $I_{OUT} = 100A$ ,  $T_A = 25^{\circ}C$ , No Airflow

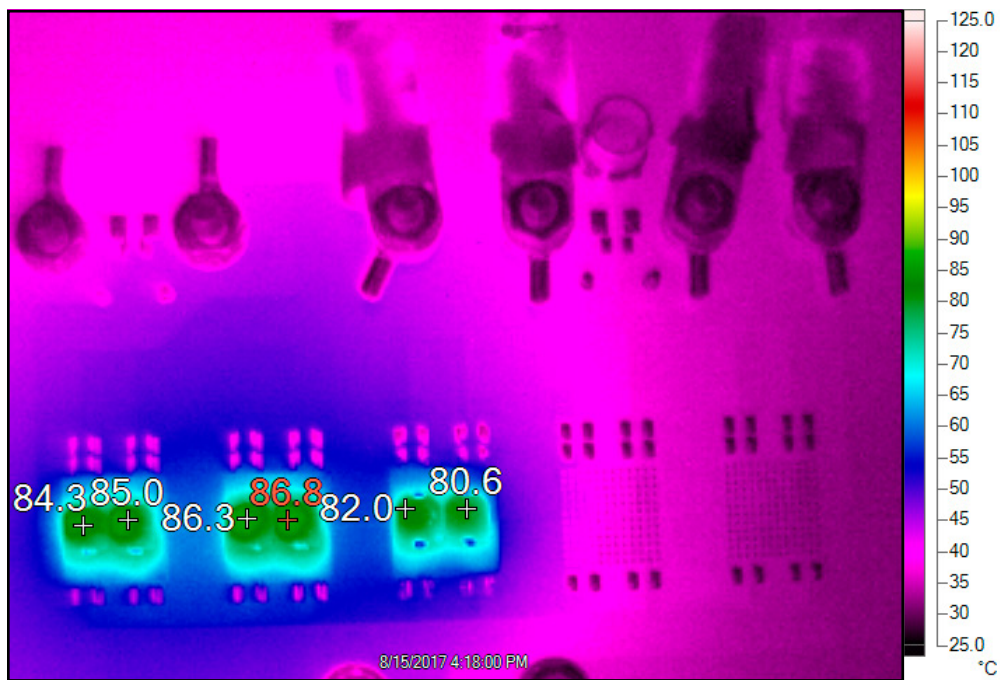

Figure 9. Thermal @  $V_{IN} = 12V$ ,  $V_{OUT} = 1.0V$ ,  $I_{OUT} = 140A$ ,  $T_A = 25^{\circ}C$ , 400LFM Airflow

## LTPOWERPLAY SOFTWARE GUI

LTpowerPlay is a powerful Windows-based development environment that supports Analog Devices power system management ICs and  $\mu$ Modules, including the LTM4675, LTM4676, LTM4677, LTM4678, LTC3880, LTC3882 and LTC3883. The software supports a variety of different tasks. You can use LTpowerPlay to evaluate Analog Devices ICs by connecting to a demo board system. LTpowerPlay can also be used in an offline mode (with no hardware present) in order to build a multichip configuration file that can be saved and reloaded at a later time. LTpowerPlay provides unprecedented diagnostic and debug features. It becomes a valuable diagnostic tool during board bringup to program or tweak the power management scheme in a system, or to diagnose power issues when bringing up rails. LTpowerPlay utilizes the

DC1613A USB-to-SMBus controller to communicate with one of many potential targets, including the LTM4675, LTM4676, LTM4677, LTM4678, LTC3880, LTC3882, LTC3883's demo system, or a customer board. The software also provides an automatic update feature to keep the software current with the latest set of device drivers and documentation. The LTpowerPlay software can be downloaded from:

### LTpowerPlay

To access technical support documents for ADI Digital Power Products visit the LTpowerPlay Help menu. Online help also available through the LTpowerPlay.

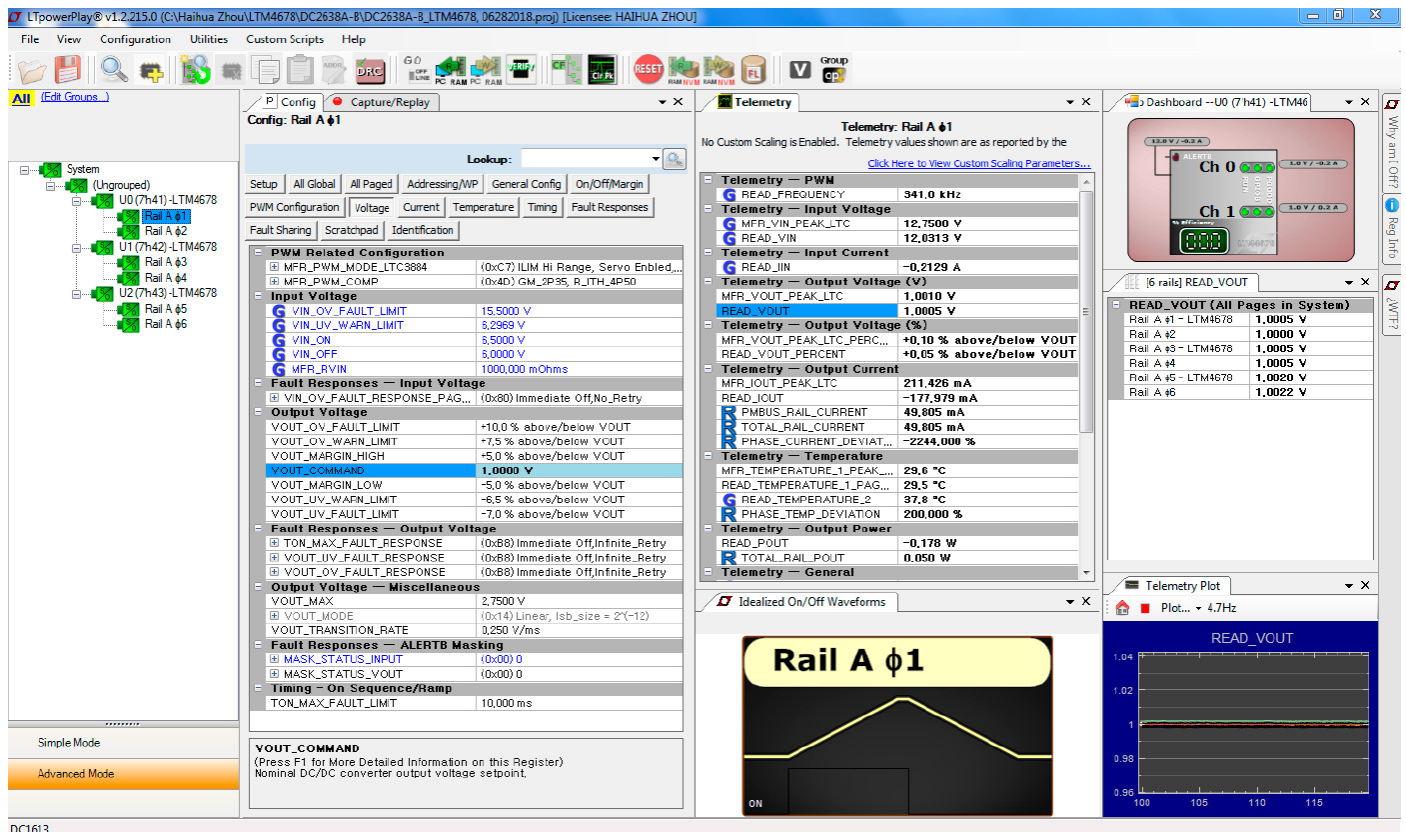

Figure 10. LTpowerPlay Main Interface

# DEMO MANUAL DC2638A-B

## LTPowerPLAY QUICK START PROCEDURE

The following procedure describes how to use LTpowerPlay to monitor and change the settings of LTM4678.

1. Download and install the LTpowerPlay GUI:

[LTpowerPlay](#)

2. Launch the LTpowerPlay GUI.

a. The GUI should automatically identify the DC2638A-B. The system tree on the left hand side should look like this:

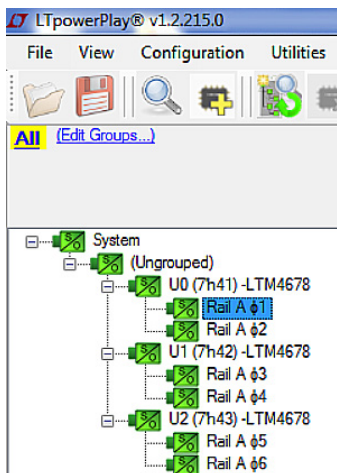

b. A green message box shows for a few seconds in the lower left corner, confirming that LTM4678 is communicating:

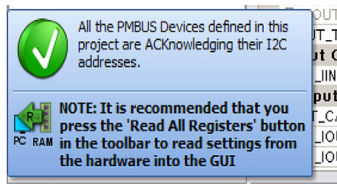

c. In the Toolbar, click the “R” (RAM to PC) icon to read the RAM from the LTM4678. This reads the configuration from the RAM of LTM4678 and loads it into the GUI.



d. If you want to change the output voltage to a different value, like 0.8V. In the Config tab, type in 0.8 in the VOUT\_COMMAND box, like this:

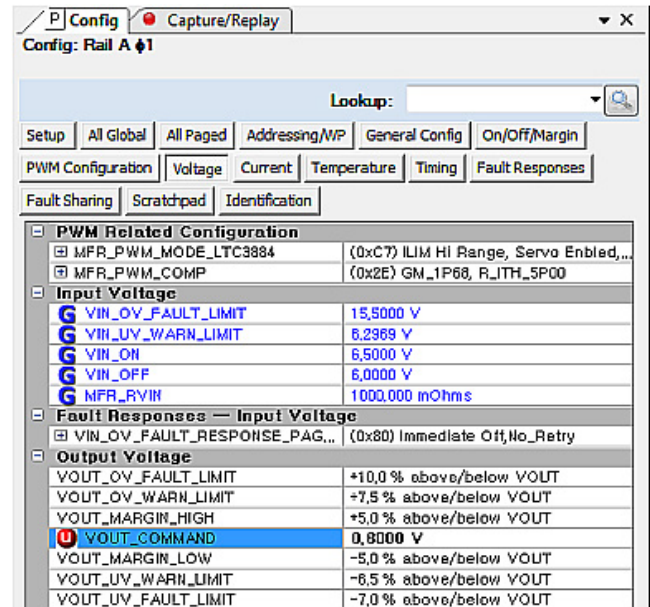

Then, click the “W” (PC to RAM) icon to write these register values to the LTM4678. After finishing this step, you will see the output voltage will change to 0.8V.



If the write is successful, you will see the following message:

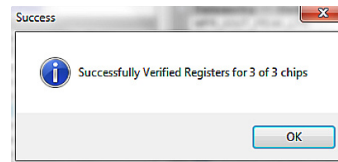

e. You can save the changes into the NVM. In the tool bar, click “RAM to NVM” button, as following



f. Save the demo board configuration to a (\*.proj) file. Click the Save icon and save the file. Name it whatever you want.



SCHEMATIC DIAGRAM

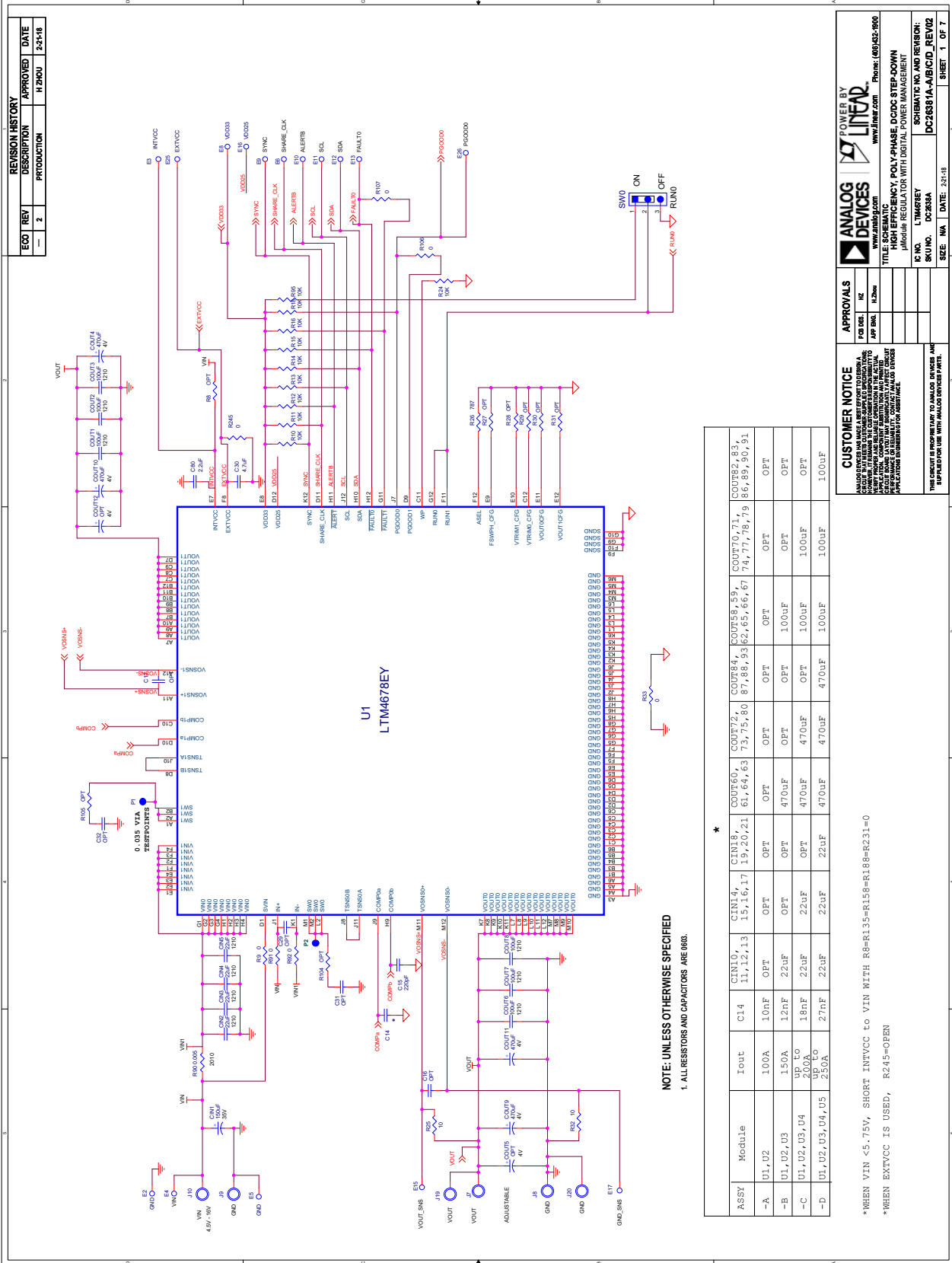

**POWER BY ANALOG DEVICES**  
www.analog.com

**LINEAR**  
www.linear.com

**APPROVALS**

APP INQ	APP INQ	APP INQ	APP INQ

**CUSTOMER NOTICE**  
THIS SCHEMATIC IS PROVIDED AS A GUIDE ONLY. THE ACTUAL PARTS LIST AND BOARD LAYOUT MAY VARY FROM THE SCHEMATIC. THE USER SHALL BE RESPONSIBLE FOR VERIFYING THE PARTS LIST AND BOARD LAYOUT. THE USER SHALL BE RESPONSIBLE FOR VERIFYING THE PARTS LIST AND BOARD LAYOUT.

**APPROVALS**

DESIGNER	DATE	DATE	DATE

**SKETCH NO. AND REVISION:** DC2638(A)-A-UB/C/D\_REV/02

**SKETCH NO. AND REVISION:** DC2638A

**SEE INQ** DATE: 2-21-18

**SHEET 1 OF 7**

# DEMO MANUAL DC2638A-B

## SCHEMATIC DIAGRAM

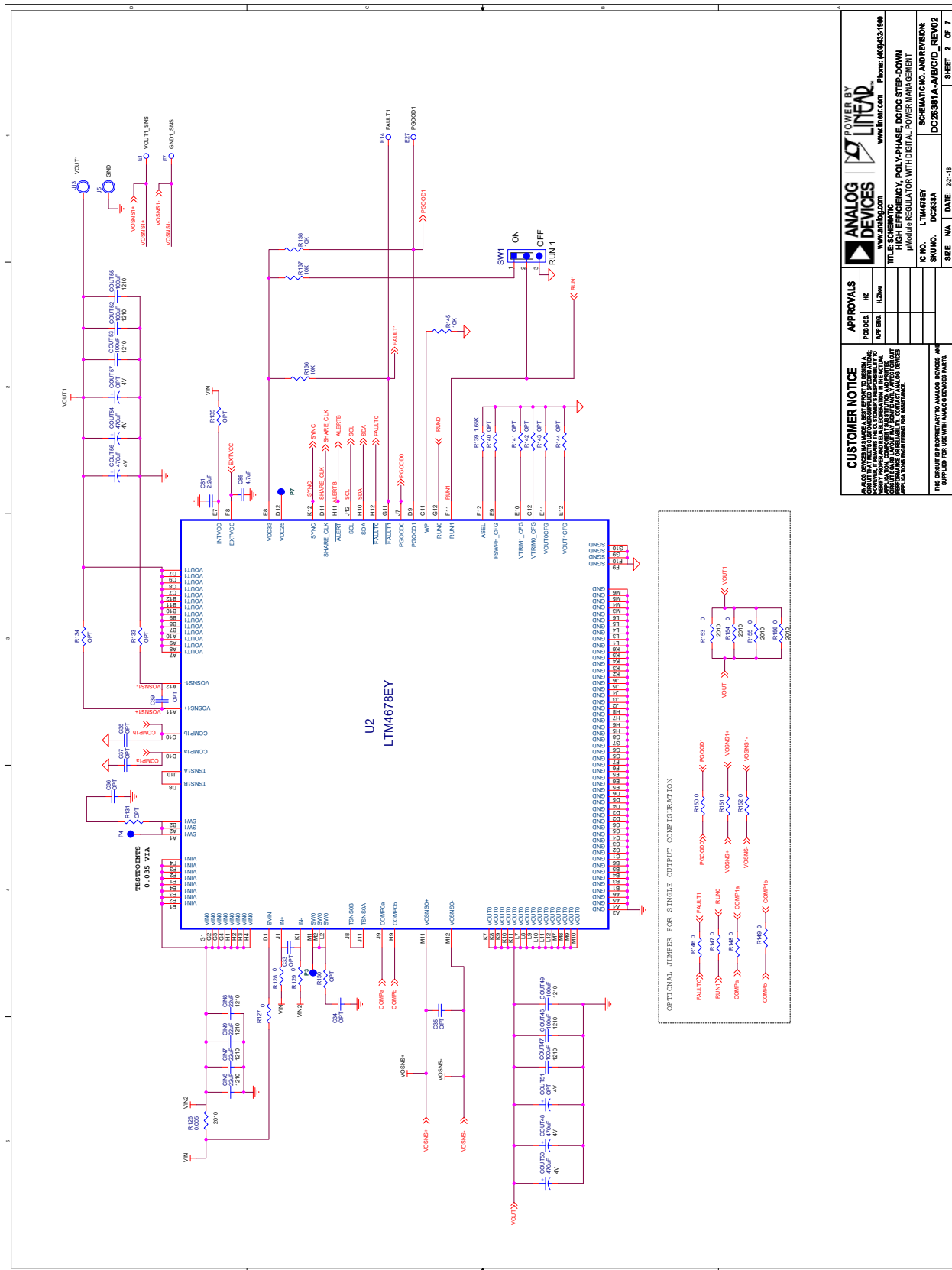

## SCHEMATIC DIAGRAM

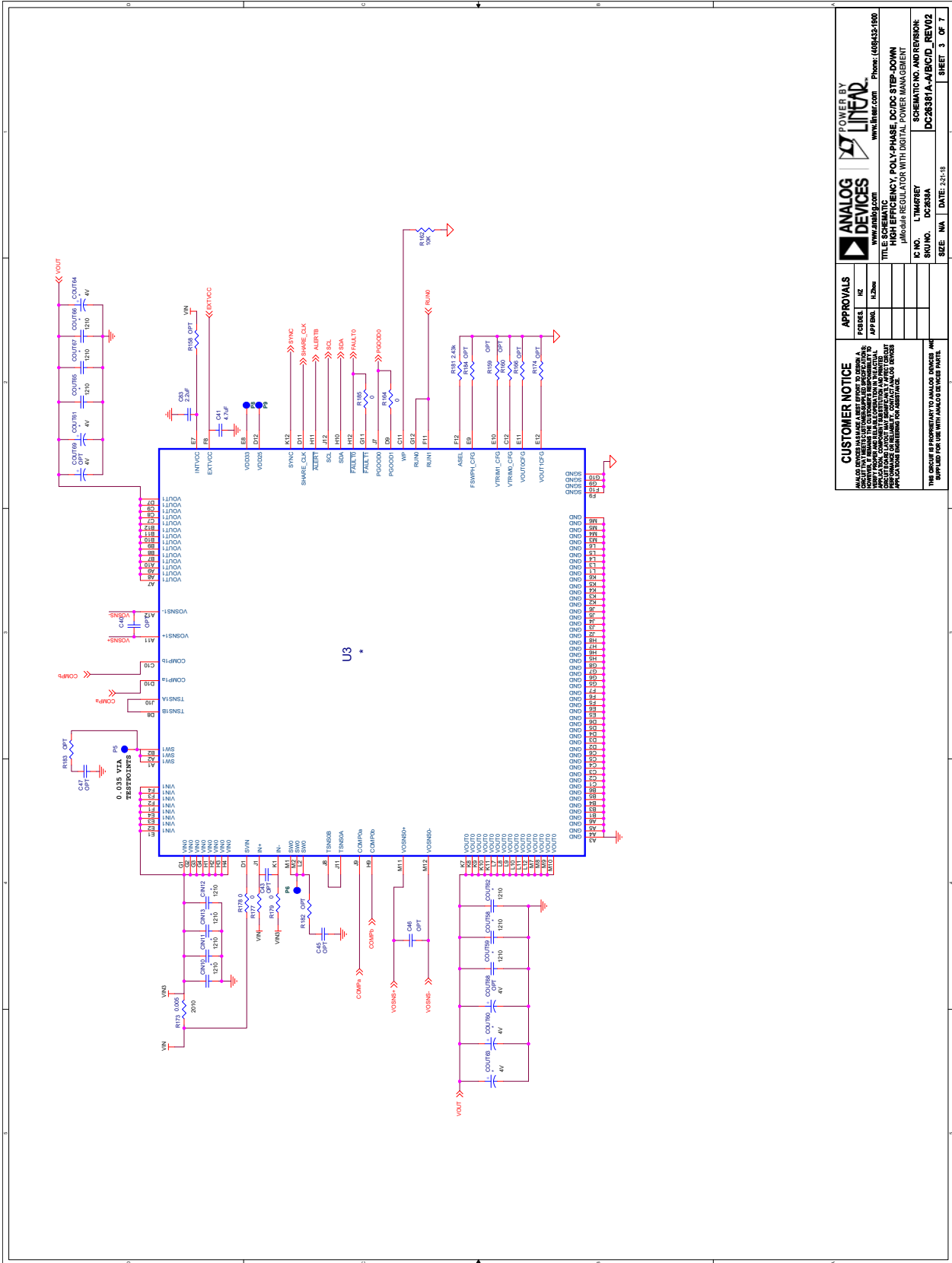

# DEMO MANUAL DC2638A-B

## SCHEMATIC DIAGRAM

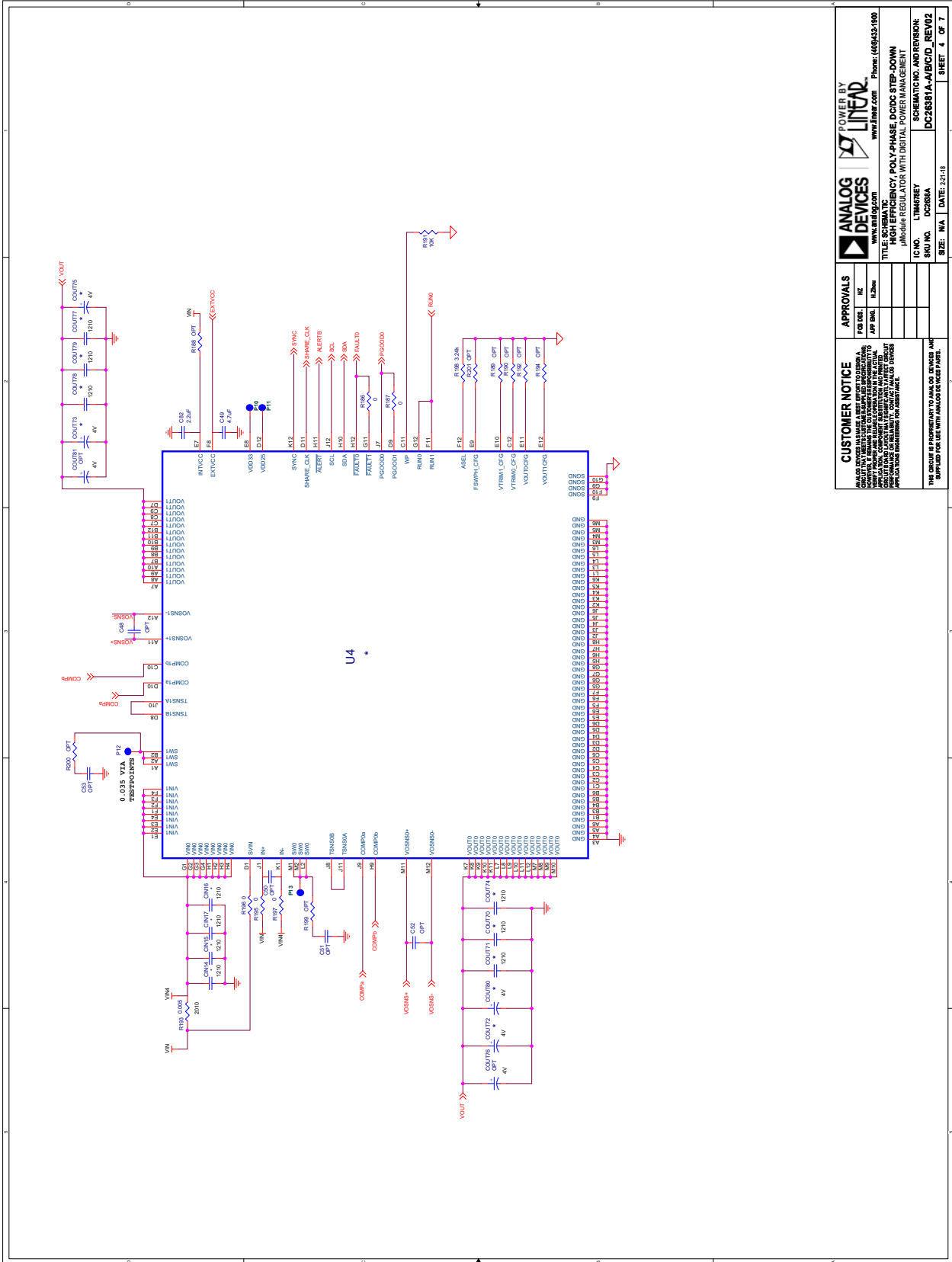

CUSTOMER NOTICE		APPROVALS	
<p>THIS SCHEMATIC IS A DEMONSTRATION OF THE FUNCTIONALITY OF THE IC. IT IS NOT A REPRESENTATION OF THE FINAL PRODUCT. THE SCHEMATIC IS PROVIDED AS A GUIDE ONLY. THE USER IS RESPONSIBLE FOR VERIFYING THE SCHEMATIC AGAINST THE IC DATA SHEET AND FOR ANY NECESSARY MODIFICATIONS TO THE SCHEMATIC TO MATCH THE USER'S APPLICATION. THE USER IS RESPONSIBLE FOR OBTAINING THE NECESSARY APPROVALS FOR THE SCHEMATIC TO BE USED IN A PRODUCT.</p>		APPROVED BY: IC DATE: 12-20-09	APPROVED BY: IC DATE: 12-20-09
<p>THIS SCHEMATIC IS A DEMONSTRATION OF THE FUNCTIONALITY OF THE IC. IT IS NOT A REPRESENTATION OF THE FINAL PRODUCT. THE SCHEMATIC IS PROVIDED AS A GUIDE ONLY. THE USER IS RESPONSIBLE FOR VERIFYING THE SCHEMATIC AGAINST THE IC DATA SHEET AND FOR ANY NECESSARY MODIFICATIONS TO THE SCHEMATIC TO MATCH THE USER'S APPLICATION. THE USER IS RESPONSIBLE FOR OBTAINING THE NECESSARY APPROVALS FOR THE SCHEMATIC TO BE USED IN A PRODUCT.</p>		TITLE: SCHEMATIC FILE: DC2638A-1A-1B/C/D PART NO.: DC2638A-1A-1B/C/D REV: 1.0	
IC NO.: LTM2638A MANUFACTURER: LINEAR		SCHEMATIC NO. AND REVISION: DC2638A-1A-1B/C/D_REV1.0	
SIZE: 11A DATE: 12-16-10		SHEET # OF 7	

## SCHEMATIC DIAGRAM

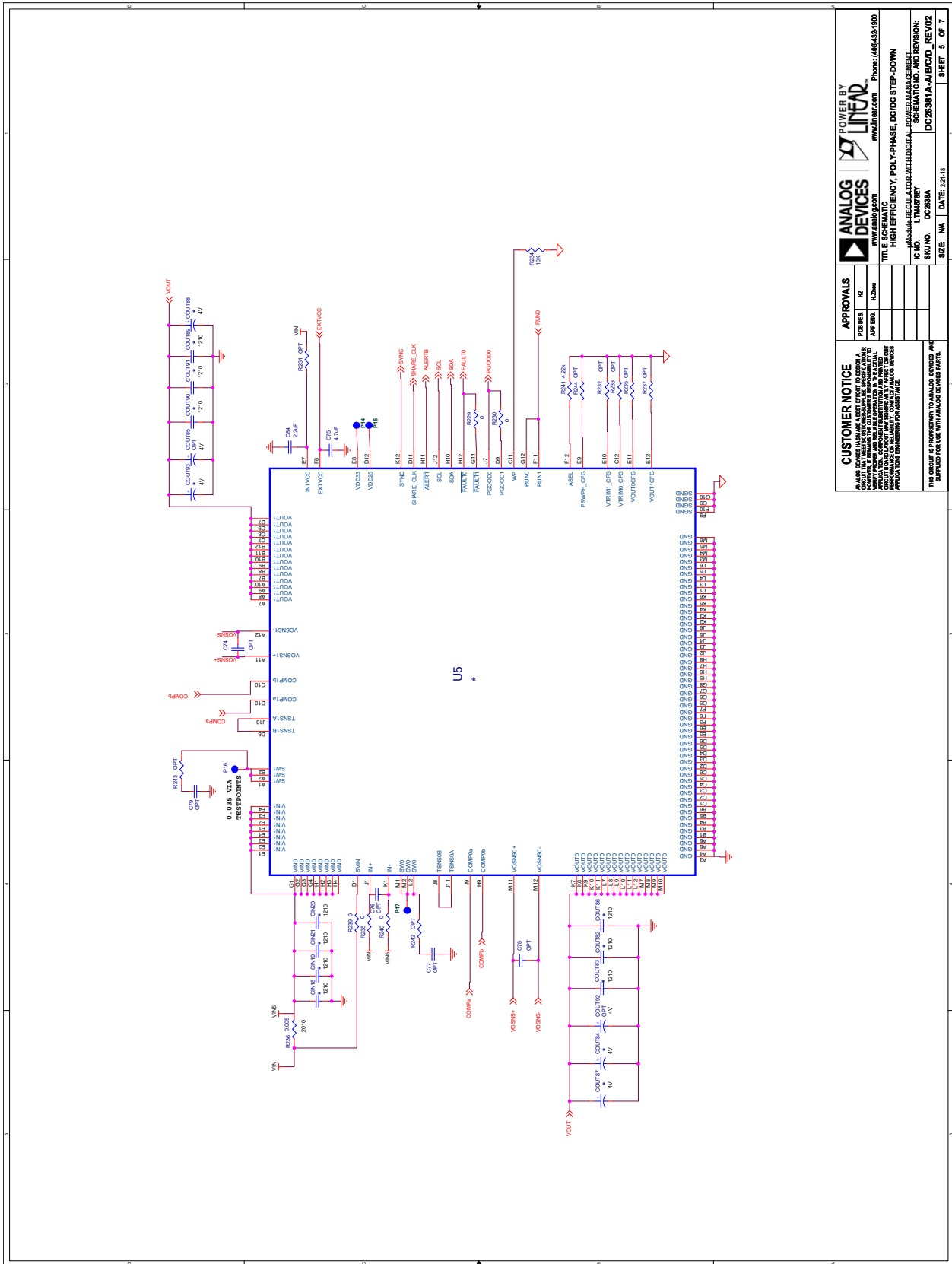

APPROVALS		ANALOG DEVICES		POWER BY LINEAR	
FIGURE	12	WWW.ANALOG.COM	WWW.LINEAR.COM	WWW.ANALOG.COM	WWW.LINEAR.COM
APP NAME	11.20m	TITLE SCHEMATIC		HIGH EFFICIENCY, POLY-PHASE, DC/DC STEP-DOWN	
		ANALOG DEVICES		LINEAR TECHNOLOGY	
		DC2638A		DC2638A-A-B/C/D, REV02	
DATE	12-11-10	SIZE	11A	SHEET	5 OF 7

**CUSTOMER NOTICE**  
 THIS SCHEMATIC IS PROVIDED AS A GUIDE ONLY. ANALOG DEVICES AND LINEAR TECHNOLOGY MAKE NO WARRANTY, REPRESENTATION OR GUARANTEE, EXPRESS OR IMPLIED, REGARDING THE ACCURACY, COMPLETENESS, OR FITNESS FOR A PARTICULAR PURPOSE OF THIS SCHEMATIC. THE USER SHALL BE RESPONSIBLE FOR VERIFYING THE ACCURACY OF THIS SCHEMATIC AND FOR OBTAINING NECESSARY APPROVALS FROM THE APPROPRIATE AUTHORITIES. ANALOG DEVICES AND LINEAR TECHNOLOGY SHALL NOT BE RESPONSIBLE FOR ANY DAMAGE TO PERSONS OR PROPERTY ARISING FROM THE USE OF THIS SCHEMATIC.

## SCHEMATIC DIAGRAM

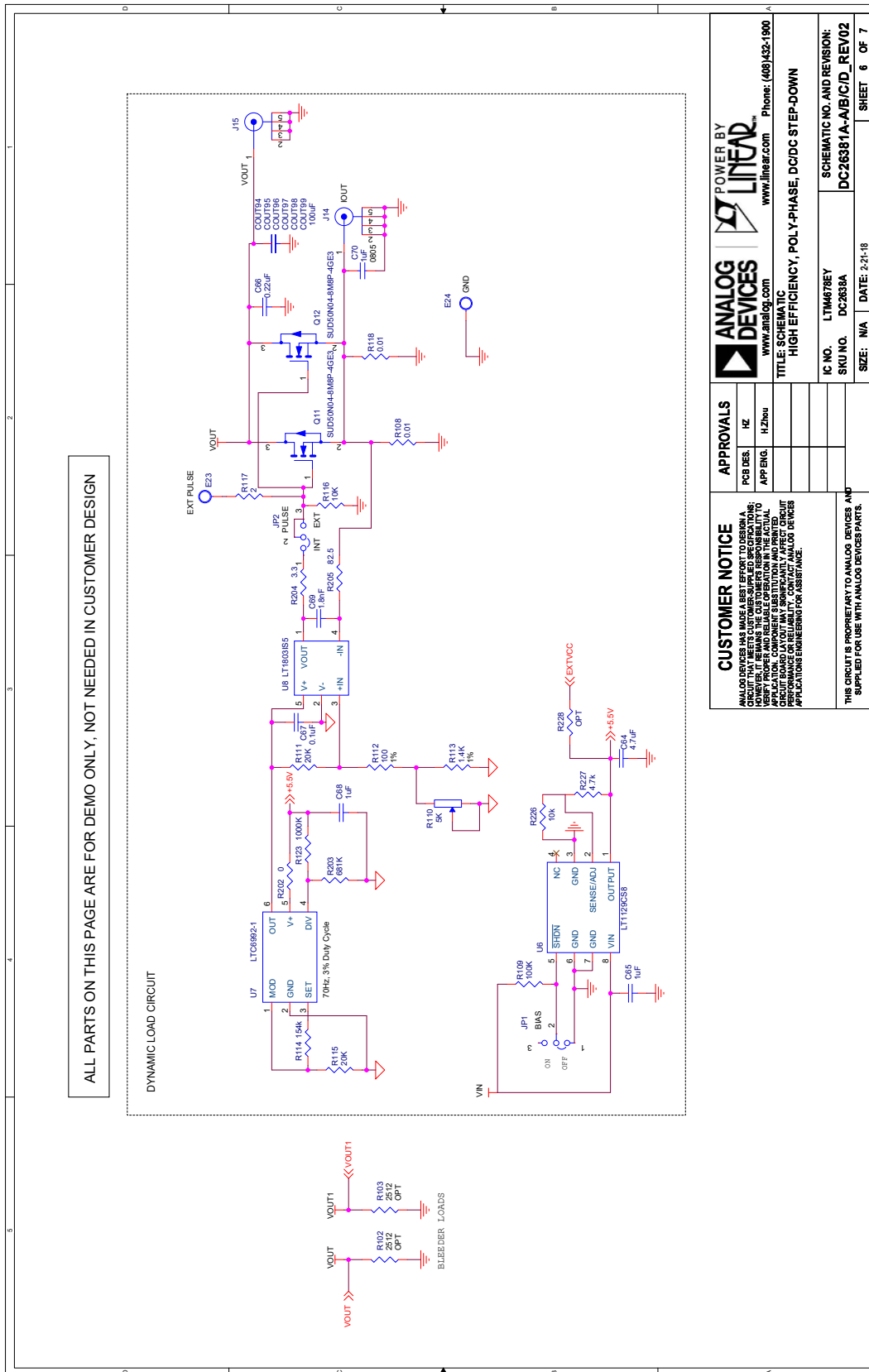

**SCHEMATIC DIAGRAM**

ALL PARTS ON THIS PAGE ARE FOR DEMO ONLY, NOT NEEDED IN CUSTOMER DESIGN

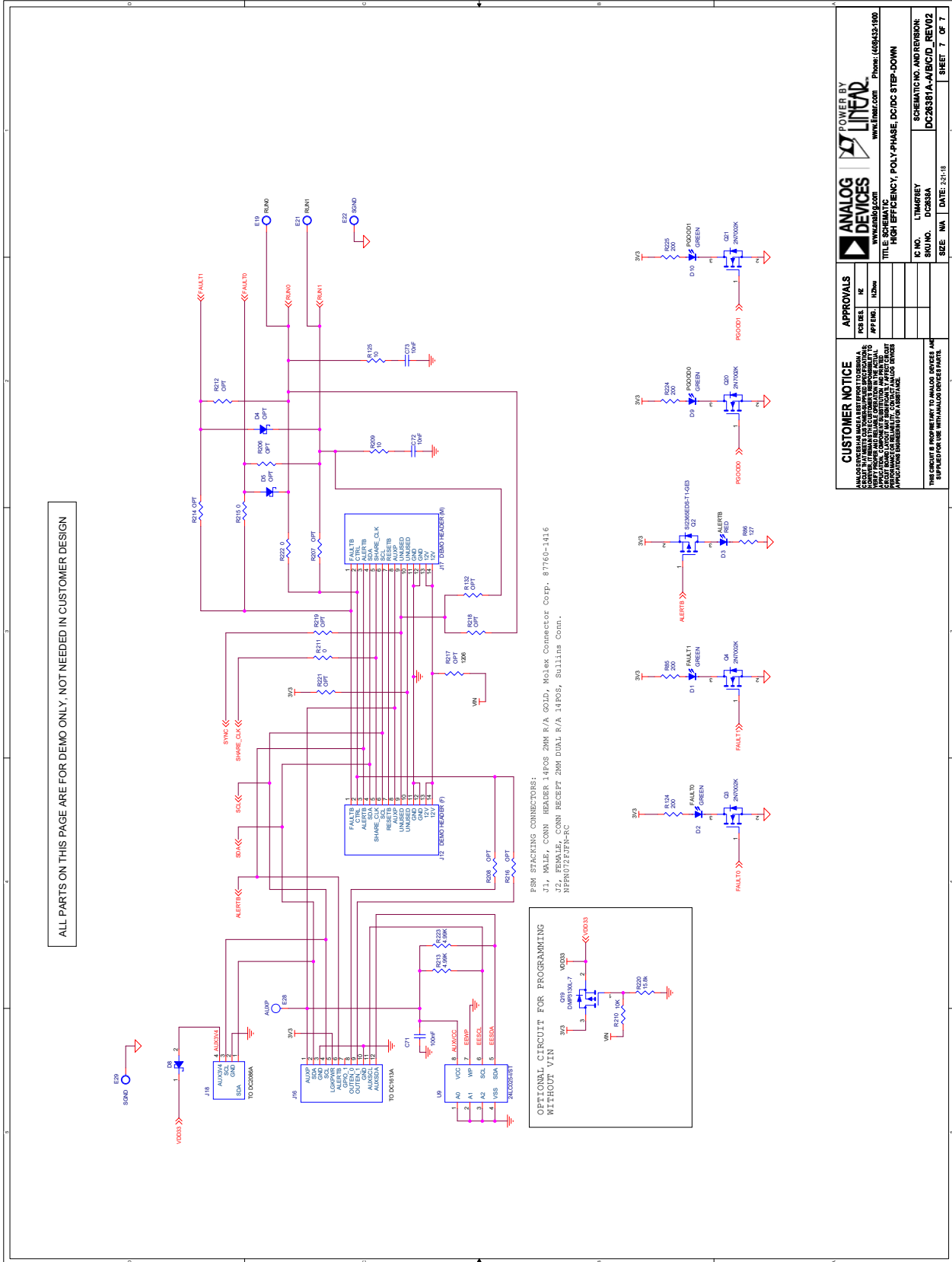

PSM STACKING CONNECTORS:  
 J1, MALE, CONN HEADER 14POS 2MM R/A GOLD, Molex Connector Corp. 87760-1416  
 J2, FEMALE, CONN RECEPT 2MM DUAL R/A 14POS, Sullins Conn. NPPH072FEM-RC

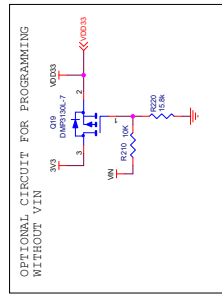

APPROVALS		POWER BY	
DESIGN	IC	ANALOG DEVICES	LINEAR
APP NO.	112909	WWW.ANALOG.COM	WWW.LINEAR.COM
TITLE: SCHEMATIC		SCHEMATIC NO. AND REVISION:	
PART EFFICIENCY, POLY-PHASE, DC/DC STEP-DOWN		DC2638A-A/B/C/D_REV02	
KNO: LTM875		SHEET 7 OF 7	
SKU NO: DC2638A		DATE: 2/1/16	

**CUSTOMER NOTICE**  
 THIS CIRCUIT IS PROVIDED AS A GUIDE ONLY. IT IS THE CUSTOMER'S RESPONSIBILITY TO VERIFY THAT ALL PARTS ARE AVAILABLE AND TO OBTAIN THE LATEST REVISIONS OF THIS SCHEMATIC. THE CUSTOMER IS RESPONSIBLE FOR OBTAINING THE LATEST REVISIONS OF THIS SCHEMATIC. THE CUSTOMER IS RESPONSIBLE FOR OBTAINING THE LATEST REVISIONS OF THIS SCHEMATIC.

# DEMO MANUAL DC2638A-B

## PARTS LIST

ITEM	QTY	REFERENCE	PART DESCRIPTION	MANUFACTURER/PART NUMBER
<b>Required Circuit Components</b>				
1	1	CIN1	CAP, 150µF, ALUM. ELECT., 35V, 20%, 8mm x 10.2mm SMD, RADIAL, AEC-Q200	PANASONIC, EEHZA1V151P
2	24	COU1, COU2, COU3, COU6, COU7, COU8, COU46, COU47, COU49, COU52, COU53, COU55, COU58, COU59, COU62, COU65, COU66, COU67, COU94, COU95, COU96, COU97, COU98, COU99	CAP, 100µF, X5R, 6.3V, 20%, 1210	AVX, 12106D107MAT2A MURATA, GRM32ER60J107ME20L TDK, C3225X5R0J107M250AC
3	12	CIN2, CIN3, CIN4, CIN5, CIN6, CIN7, CIN8, CIN9, CIN10, CIN11, CIN12, CIN13	CAP, 22µF, X5R, 25V, 10%, 1210	AVX, 12103D226KAT2A MURATA, GRM32ER61E226KE15L TAIYO YUDEN, TMK325BJ226KM-P TAIYO YUDEN, TMK325BJ226KM-T
4	12	COU4, COU9, COU10, COU11, COU48, COU50, COU54, COU56, COU60, COU61, COU63, COU64	CAP, 470µF, TANT. POSCAP, 4V, 20%, 7343, 10mΩ, TPF, NO SUBS. ALLOWED	PANASONIC, 4TPF470ML
5	1	C14	CAP, 0.012µF, X7R, 16V, 10V, 0603	AVX, 0603YC123KAT2A KEMET, C0603C123K4RACTU NIC, NMC0603X7R123K16TRPF
6	1	C15	CAP, 220pF, X7R, 16V, 10%, 0603	AVX, 0603YC221KAT2A KEMET, C0603C221K4RACTU NIC, NMC0603X7R221K16TRPF
7	6	C30, C41, C49, C64, C75, C85	CAP, 4.7µF, X5R, 25V, 10%, 0603, NO SUBS. ALLOWED	MURATA, GRM188R61E475KE11D
8	2	C65, C68	CAP, 1µF, X7R, 25V, 10%, 1206	AVX, 12063C105KAT2A MURATA, GRM31MR71E105KA01L TAIYO YUDEN, TMK316B7105KL-T TDK, C3216X7R1E105K160AA
9	1	C66	CAP, 0.22µF, X5R, 25V, 10%, 0805	AVX, 08053D224KAT2A TAIYO YUDEN, TMK212BJ224KGHT VENKEL LTD., C0805X5R250-224KNE
10	1	C67	CAP, 0.1µF, X7R, 25V, 10%, 1206	AVX, 12063C104KAT2A NIC, NMC1206X7R104K25TRPF
11	1	C69	CAP, 1800pF, X7R, 16V, 10%, 0603	AVX, 0603YC182KAT2A KEMET, C0603C182K4RACTU NIC, NMC0603X7R182K16TRPF
12	1	C70	CAP, 1µF, X5R, 25V, 10%, 0805	AVX, 08053D105KAT2A MURATA, GRM216R61E105KA12D TDK, CGB4B3X5R1E105K055AB
13	1	C71	CAP, 0.1µF, X7R, 25V, 10%, 0603	AVX, 06033C104KAT2A KEMET, C0603C104K3RACTU NIC, NMC0603X7R104K25TRPF TDK, C1608X7R1E104K080AA
14	2	C72, C73	CAP, 0.01µF, X7R, 25V, 10%, 0603	AVX, 06033C103KAT2A MURATA, GRM188R71E103KA01D YAGEO, CC0603KRX7R8BB103
15	5	C80, C81, C82, C83, C84	CAP, 2.2µF, X7R, 25V, 10%, 0603	MURATA, GRM188Z71E225KE43D
16	4	D1, D2, D9, D10	LED, GREEN, WATERCLEAR, 0603	WURTH ELEKTRONIK, 150060GS75000
17	1	D3	LED, SUPER RED, WATERCLEAR, 0603	WURTH ELEKTRONIK, 150060SS75000
18	1	D8	DIODE, SCHOTTKY RECT., 20V, 0.5A, SOD-882D, LEADLESS, 2-TERM.	NEXPERIA, PMEG2005AELD, 315
19	1	Q2	XSTR., MOSFET, P-CH, 20V, 5.9A, TO-236 (SOT23-3)	VISHAY, SI2365EDS-T1-GE3

Rev. 0



## PARTS LIST

ITEM	QTY	REFERENCE	PART DESCRIPTION	MANUFACTURER/PART NUMBER
<b>Required Circuit Components</b>				
20	4	Q3, Q4, Q20, Q21	XSTR., MOSFET, SINGLE N-CH, 60V, 380mA, SOT23-3, AEC-Q101	ON SEMICONDUCTOR, 2N7002KT1G
21	2	Q11, Q12	XSTR., MOSFET, N-CH, 40V, TO-252 (DPAK)	VISHAY, SUD50N04-8M8P-4GE3
22	1	Q19	XSTR., MOSFET, P-CH, 30V, 3.5A, SOT23-3, AEC-Q101	DIODES INC., DMP3130L-7
23	36	R9, R33, R91, R92, R106, R107, R127, R128, R129, R146, R147, R148, R149, R150, R151, R152, R164, R177, R178, R179, R185, R186, R187, R195, R196, R197, R202, R211, R215, R222, R229, R230, R238, R239, R240, R245	RES., 0 $\Omega$ , 1/10W, 0603, AEC-Q200	NIC, NRC06ZOTRF VISHAY, CRCW06030000Z0EA
24	20	R10, R11, R12, R13, R14, R15, R16, R18, R24, R95, R116, R136, R137, R138, R145, R162, R191, R210, R226, R234	RES., 10k, 1%, 1/10W, 0603, AEC-Q200	KOA SPEER, RK73H1JTDD1002F PANASONIC, ERJ3EKF1002V VISHAY, CRCW060310K0FKEA
25	4	R25, R32, R125, R209	RES., 10 $\Omega$ , 1%, 1/10W, 0603	NIC, NRC06F10R0TRF PANASONIC, ERJ3EKF10R0V ROHM, MCR03EZPFX10R0 VISHAY, CRCW060310R0FKEA YAGEO, RC0603FR-0710RL
26	1	R26	RES., 787 $\Omega$ , 1%, 1/10W, 0603, AEC-Q200	NIC, NRC06F7870TRF PANASONIC, ERJ3EKF7870V VISHAY, CRCW0603787RFKEA
27	4	R85, R124, R224, R225	RES., 200 $\Omega$ , 1%, 1/10W, 0603	NIC, NRC06F2000TRF VISHAY, CRCW0603200RFKEA YAGEO, RC0603FR-07200RL
28	1	R86	RES., 127 $\Omega$ , 1%, 1/10W, 0603, AEC-Q200	NIC, NRC06F1270TRF PANASONIC, ERJ3EKF1270V VISHAY, CRCW0603127RFKEA
29	5	R90, R126, R173, R193, R236	RES., 0.005 $\Omega$ , 1%, 1/2W, 2010, SENSE, AEC-Q200	VISHAY, WSL20105L000FEA
30	2	R108, R118	RES., 0.01 $\Omega$ , 1%, 1/2W, 2010, SENSE, AEC-Q200	VISHAY, WSL2010R0100FEA
31	1	R109	RES., 100k, 1%, 1/10W, 0603, AEC-Q200	NIC, NRC06F1003TRF PANASONIC, ERJ3EKF1003V VISHAY, CRCW0603100KFKEA
32	1	R110	RES., 5k, 10%, 1/2W, THT 3/8 SQ, 1-TURN, TOP ADJ., TRIMPOT	
33	2	R111, R115	RES., 20k, 1%, 1/10W, 0603	PANASONIC, ERJ3EKF2002V VISHAY, CRCW060320K0FKEA YAGEO, RC0603FR-0720KL
34	1	R112	RES., 100 $\Omega$ , 1%, 1/10W, 0603, AEC-Q200	NIC, NRC06F1000TRF PANASONIC, ERJ3EKF1000V VISHAY, CRCW0603100RFKEA
35	1	R113	RES., 1.4k, 1%, 1/10W, 0603, AEC-Q200	NIC, NRC06F1401TRF PANASONIC, ERJ3EKF1401V VISHAY, CRCW06031K40FKEA
36	1	R114	RES., 154k, 1%, 1/10W, 0603, AEC-Q200	NIC, NRC06F1543TRF PANASONIC, ERJ3EKF1543V VISHAY, CRCW0603154KFKEA
37	1	R117	RES., 2 $\Omega$ , 1%, 1/10W, 0603, AEC-Q200	VISHAY, CRCW06032R00FKEA
38	1	R123	RES., 1M $\Omega$ , 1%, 1/10W, 0603, AEC-Q200	NIC, NRC06F1004TRF PANASONIC, ERJ3EKF1004V VISHAY, CRCW06031M00FKEA

# DEMO MANUAL DC2638A-B

## PARTS LIST

ITEM	QTY	REFERENCE	PART DESCRIPTION	MANUFACTURER/PART NUMBER
<b>Required Circuit Components</b>				
39	1	R139	RES., 1.65k, 1%, 1/10W, 0603, AEC-Q200	NIC, NRC06F1651TRF PANASONIC, ERJ3EKF1651V VISHAY, CRCW06031K65FKEA
40	4	R153, R154, R155, R156	RES., 0Ω, 3/4W, 2010, AEC-Q200	NIC, NRC50ZOTRF PANASONIC, ERJ12ZY0R00U VISHAY, CRCW20100000Z0EF
41	1	R181	RES., 2.43k, 1%, 1/10W, 0603, AEC-Q200	NIC, NRC06F2431TRF PANASONIC, ERJ3EKF2431V VISHAY, CRCW06032K43FKEA
42	1	R198	RES., 3.24k, 1%, 1/10W, 0603, AEC-Q200	NIC, NRC06F3241TRF PANASONIC, ERJ3EKF3241V VISHAY, CRCW06033K24FKEA
43	1	R203	RES., 681k, 1%, 1/10W, 0603, AEC-Q200	NIC, NRC06F6813TRF PANASONIC, ERJ3EKF6813V VISHAY, CRCW0603681KFKEA
44	1	R204	RES., 3.3Ω, 1%, 1/10W, 0603, AEC-Q200	VISHAY, CRCW06033R30FKEA
45	1	R205	RES., 82.5Ω, 1%, 1/10W, 0603, AEC-Q200	NIC, NRC06F82R5TRF PANASONIC, ERJ3EKF82R5V VISHAY, CRCW060382R5FKEA
46	2	R213, R223	RES., 4.99k, 1%, 1/10W, 0603, AEC-Q200	NIC, NRC06F4991TRF PANASONIC, ERJ3EKF4991V VISHAY, CRCW06034K99FKEA
47	0	R217	RES., OPTION, 1206	
48	1	R220	RES., 15.8k, 1%, 1/10W, 0603, AEC-Q200	NIC, NRC06F1582TRF PANASONIC, ERJ3EKF1582V VISHAY, CRCW060315K8FKEA
49	1	R227	RES., 4.7k, 1%, 1/10W, 0603, AEC-Q200	NIC, NRC06F4701TRF PANASONIC, ERJ3EKF4701V VISHAY, CRCW06034K70FKEA
50	1	R241	RES., 4.22k, 1%, 1/10W, 0603, AEC-Q200	NIC, NRC06F4221TRF PANASONIC, ERJ3EKF4221V VISHAY, CRCW06034K22FKEA
51				
52	3	U1, U2, U3	IC, DUAL 25A POP PSM MODULE, BGA-144	ANALOG DEVICES, LTM4678EY#PBF
53	1	U6	IC, 700mA μPower LDO with SHUTDOWN, SO-8	ANALOG DEVICES, LT1129CS8#PBF ANALOG DEVICES, LT1129CS8#TRPBF
54	1	U7	IC, TIMERBLOX: VOLTAGE-CTRL. PWM, TSOT23-6	ANALOG DEVICES, LTC6992CS6-1#PBF ANALOG DEVICES, LTC6992CS6-1#TRMPBF ANALOG DEVICES, LTC6992CS6-1#TRPBF
55	1	U8	IC, SINGLE R TO R IN/OUT OP AMP, TSOT23-5, 100V/μs, 85MHz	ANALOG DEVICES, LT1803IS5#PBF ANALOG DEVICES, LT1803IS5#TRMPBF ANALOG DEVICES, LT1803IS5#TRPBF
56	1	U9	IC, MEMORY, EEPROM, 2Kb (256x8), TSSOP-8, 400kHz	MICROCHIP, 24LC025-I/ST MICROCHIP, 24LC025T-I/ST
<b>Additional Demo Board Circuit Components</b>				
1	0	COU5, COU12, COU51, COU57, COU68, COU69, COU72, COU73, COU75, COU76, COU80, COU81, COU84, COU85, COU87, COU88, COU92, COU93	CAP, OPTION, D3L	

## PARTS LIST

ITEM	QTY	REFERENCE	PART DESCRIPTION	MANUFACTURER/PART NUMBER
<b>Additional Demo Board Circuit Components</b>				
2	0	CIN14, CIN15, CIN16, CIN17, CIN18, CIN19, CIN20, CIN21, COUT70, COUT71, COUT74, COUT77, COUT78, COUT79, COUT82, COUT83, COUT86, COUT89, COUT90, COUT91	CAP, OPTION, 1210	
3	0	C16, C17, C29, C31, C32, C33, C34, C35, C36, C37, C38, C39, C40, C43, C45, C46, C47, C48, C50, C51, C52, C53, C74, C76, C77, C78, C79	CAP, OPTION, 0603	
4	0	D4, D5	DIODE, OPTION, SOD-323	
5	0	R8, R27, R28, R29, R30, R31, R104, R105, R130, R131, R132, R133, R134, R135, R140, R141, R142, R143, R144, R158, R159, R160, R166, R174, R182, R183, R184, R188, R189, R190, R192, R194, R199, R200, R201, R206, R207, R208, R212, R214, R216, R218, R219, R221, R228, R231, R232, R233, R235, R237, R242, R243, R244	RES., OPTION, 0603	
6	0	R102, R103	RES., OPTION, 2512	
7	0	U4, U5	IC., OPTION, BGA-144	
8	0		PCA ASSY DWG, DC2638A	
<b>Hardware: For Demo Board Only</b>				
1	27	E1, E2, E3, E4, E5, E6, E7, E8, E9, E10, E11, E12, E13, E14, E15, E16, E17, E20, E21, E22, E23, E24, E25, E26, E27, E28, E29	TEST POINT, TURRET, 0.064, MTG. HOLE	MILL-MAX, 2308-2-00-80-00-00-07-0
2	2	JP1, JP2	CONN., HDR, MALE, 1x3, 2mm, VERT, STR, THT	WURTH ELEKTRONIK, 62000311121
3	8	J5, J7, J8, J9, J10, J13, J19, J20	STUD, FASTENER, #10-32	PENNINGENGINEERING, KFH-032-10ET
4	8	J5, J7, J8, J9, J10, J13, J19, J20	WASHER, FLAT, STEEL, ZINC PLATE, OD: 0.436 [11.1]	KEYSTONE, 4703
5	8	J5, J7, J8, J9, J10, J13, J19, J20	RING, LUG, CRIMP, #10, NON-INSULATED, SOLDERLESS TERMINALS	KEYSTONE, 8205
6	16	J5, J7, J8, J9, J10, J13, J19, J20	NUT, HEX, STEEL, ZINC PLATE, 10-32	KEYSTONE, 4705
7	1	J12	CONN., HDR, FEMALE, 2x7, 2mm, R/A THT	SULLINS CONNECTOR SOLUTIONS, NPPN072FJFN-RC
8	2	J14, J15	CONN., RF BNC, RCPT JACK, 5-PIN, STR, THT, 50Ω	AMPHENOL RF, 112404
9	1	J16	CONN., SHROUDED HDR, MALE, 2x6, 2mm, VERT, STR, THT	FCI, 98414-G06-12ULF
10	1	J17	CONN., HDR, MALE, 2x7, 2mm, R/A THT	MOLEX, 0877601416 MOLEX, 87760-1416
11	1	J18	CONN., SHROUDED HDR, MALE, 1x4, 2mm, VERT, STR, THT	HIROSE ELECTRIC, DF3A-4P-2DSA
12	2	SW0, SW1	CONN., HDR., MALE, 1x3, 2mm, VERT, STR, THT, 10μ Au	SAMTEC, TMM-103-02-L-S
13	1	LB1	LABEL SPEC, DEMO BOARD SERIAL NUMBER	BRADY, THT-96-717-10
14	4	MH1, MH2, MH3, MH4	STANDOFF, NYLON, SNAP-ON, 0.50	WURTH ELEKTRONIK, 702935000
15	2	XJP1	CONN., SHUNT, FEMALE, 2 POS, 2mm	WURTH ELEKTRONIK, 60800213421
16	1		PCB, DC2638A	MAO BANG, 600-DC2638A
17	1		TOOL, STENCIL, 700-DC2638A	ANALOG DEVICES, 830-DC2638A



## ESD Caution

**ESD (electrostatic discharge) sensitive device.** Charged devices and circuit boards can discharge without detection. Although this product features patented or proprietary protection circuitry, damage may occur on devices subjected to high energy ESD. Therefore, proper ESD precautions should be taken to avoid performance degradation or loss of functionality.

## Legal Terms and Conditions

By using the evaluation board discussed herein (together with any tools, components documentation or support materials, the "Evaluation Board"), you are agreeing to be bound by the terms and conditions set forth below ("Agreement") unless you have purchased the Evaluation Board, in which case the Analog Devices Standard Terms and Conditions of Sale shall govern. Do not use the Evaluation Board until you have read and agreed to the Agreement. Your use of the Evaluation Board shall signify your acceptance of the Agreement. This Agreement is made by and between you ("Customer") and Analog Devices, Inc. ("ADI"), with its principal place of business at One Technology Way, Norwood, MA 02062, USA. Subject to the terms and conditions of the Agreement, ADI hereby grants to Customer a free, limited, personal, temporary, non-exclusive, non-sublicensable, non-transferable license to use the Evaluation Board FOR EVALUATION PURPOSES ONLY. Customer understands and agrees that the Evaluation Board is provided for the sole and exclusive purpose referenced above, and agrees not to use the Evaluation Board for any other purpose. Furthermore, the license granted is expressly made subject to the following additional limitations: Customer shall not (i) rent, lease, display, sell, transfer, assign, sublicense, or distribute the Evaluation Board; and (ii) permit any Third Party to access the Evaluation Board. As used herein, the term "Third Party" includes any entity other than ADI, Customer, their employees, affiliates and in-house consultants. The Evaluation Board is NOT sold to Customer; all rights not expressly granted herein, including ownership of the Evaluation Board, are reserved by ADI. CONFIDENTIALITY. This Agreement and the Evaluation Board shall all be considered the confidential and proprietary information of ADI. Customer may not disclose or transfer any portion of the Evaluation Board to any other party for any reason. Upon discontinuation of use of the Evaluation Board or termination of this Agreement, Customer agrees to promptly return the Evaluation Board to ADI. ADDITIONAL RESTRICTIONS. Customer may not disassemble, decompile or reverse engineer chips on the Evaluation Board. Customer shall inform ADI of any occurred damages or any modifications or alterations it makes to the Evaluation Board, including but not limited to soldering or any other activity that affects the material content of the Evaluation Board. Modifications to the Evaluation Board must comply with applicable law, including but not limited to the RoHS Directive. TERMINATION. ADI may terminate this Agreement at any time upon giving written notice to Customer. Customer agrees to return to ADI the Evaluation Board at that time. LIMITATION OF LIABILITY. THE EVALUATION BOARD PROVIDED HEREUNDER IS PROVIDED "AS IS" AND ADI MAKES NO WARRANTIES OR REPRESENTATIONS OF ANY KIND WITH RESPECT TO IT. ADI SPECIFICALLY DISCLAIMS ANY REPRESENTATIONS, ENDORSEMENTS, GUARANTEES, OR WARRANTIES, EXPRESS OR IMPLIED, RELATED TO THE EVALUATION BOARD INCLUDING, BUT NOT LIMITED TO, THE IMPLIED WARRANTY OF MERCHANTABILITY, TITLE, FITNESS FOR A PARTICULAR PURPOSE OR NON-INFRINGEMENT OF INTELLECTUAL PROPERTY RIGHTS. IN NO EVENT WILL ADI AND ITS LICENSORS BE LIABLE FOR ANY INCIDENTAL, SPECIAL, INDIRECT, OR CONSEQUENTIAL DAMAGES RESULTING FROM CUSTOMER'S POSSESSION OR USE OF THE EVALUATION BOARD, INCLUDING BUT NOT LIMITED TO LOST PROFITS, DELAY COSTS, LABOR COSTS OR LOSS OF GOODWILL. ADI'S TOTAL LIABILITY FROM ANY AND ALL CAUSES SHALL BE LIMITED TO THE AMOUNT OF ONE HUNDRED US DOLLARS (\$100.00). EXPORT. Customer agrees that it will not directly or indirectly export the Evaluation Board to another country, and that it will comply with all applicable United States federal laws and regulations relating to exports. GOVERNING LAW. This Agreement shall be governed by and construed in accordance with the substantive laws of the Commonwealth of Massachusetts (excluding conflict of law rules). Any legal action regarding this Agreement will be heard in the state or federal courts having jurisdiction in Suffolk County, Massachusetts, and Customer hereby submits to the personal jurisdiction and venue of such courts. The United Nations Convention on Contracts for the International Sale of Goods shall not apply to this Agreement and is expressly disclaimed.