

## High temperature 16 A 600 V TO220 thyristor SCRs

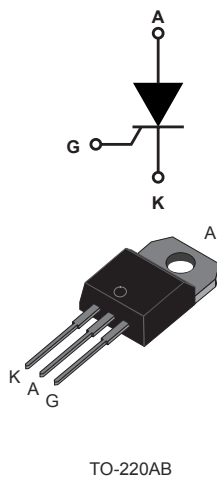

### Features

- High junction temperature:  $T_j = 150\text{ }^\circ\text{C}$
- High noise immunity  $dV/dt = 1000\text{V}/\mu\text{s}$  up to  $150\text{ }^\circ\text{C}$
- Gate triggering current  $I_{GT} = 10\text{ mA}$
- Peak off-state voltage  $V_{DRM}/V_{RRM} = 600\text{ V}$
- High turn-on current rise  $dI/dt = 100\text{ A}/\mu\text{s}$
- ECOPACK<sup>®</sup>2 compliant

### Applications

- Motorbike voltage regulator circuits
- Inrush current limiting circuits
- Motor control circuits and starters
- Solid state relays

### Description

Thanks to a junction temperature  $T_j$  up to  $150\text{ }^\circ\text{C}$  and a non-isolated TO-220 package, the TN1610H-6T offers high thermal performance operation up to 16 A rms.

The trade-off between the device's noise immunity ( $dV/dt = 1\text{ kV}/\mu\text{s}$ ), its gate triggering current ( $I_{GT} = 10\text{ mA}$ ) and its turn-on current rise ( $dI/dt = 100\text{ A}/\mu\text{s}$ ) allows the design of robust and compact control circuits for voltage regulators in motorbikes and industrial drives, overvoltage crowbar protection, motor control circuits in power tools and kitchen appliances and inrush current limiting circuits.

Product status	
TN1610H-6T	
Product summary	
Order code	TN1610H-6T
Package	TO-220AB
$V_{DRM}/V_{RRM}$	600 V
$I_{GT}$	10 mA

# 1 Characteristics

**Table 1. Absolute maximum ratings (limiting values),  $T_j = 25\text{ °C}$  unless otherwise specified**

Symbol	Parameter		Value	Unit
$I_{T(RMS)}$	RMS on-state current (180 ° conduction angle)		$T_c = 133\text{ °C}$ 16	A
$I_{T(AV)}$	Average on-state current (180 ° conduction angle)		$T_c = 133\text{ °C}$ 10	A
			$T_c = 138\text{ °C}$ 8	
			$T_c = 142\text{ °C}$ 6	
$I_{TSM}$	Non repetitive surge peak on-state current ( $T_j$ initial = 25 °C)		$t_p = 8.3\text{ ms}$ 153	A
			$t_p = 10\text{ ms}$ 140	
$I^2t$	$I^2t$ value for fusing, ( $T_j$ initial = 25 °C)		$t_p = 10\text{ ms}$ 98	$A^2s$
$di/dt$	$I_G = 2 \times I_{GT}$ , $t_r \leq 100\text{ ns}$ Critical rate of rise of on-state current		$f = 60\text{ Hz}$ 100	$A/\mu s$
$V_{DRM}/V_{RRM}$	Repetitive peak off-state voltage		600	V
$I_{GM}$	Peak gate current	$t_p = 20\text{ }\mu s$	$T_j = 150\text{ °C}$ 4	A
$P_{G(AV)}$	Average gate power dissipation		$T_j = 150\text{ °C}$ 1	W
$T_{stg}$	Storage junction temperature range		-40 to +150	°C
$T_j$	Maximum operating junction temperature		-40 to +150	°C
$T_l$	Maximum lead temperature soldering during 10 s		260	°C

**Table 2. Electrical characteristics ( $T_j = 25\text{ °C}$  unless otherwise specified)**

Symbol	Test conditions		Value	Unit	
$I_{GT}$	$V_D = 12\text{ V}$ , $R_L = 33\text{ }\Omega$		Typ.	4.5	mA
			Max.	10	
$V_{GT}$			Max.	1.3	V
$V_{GD}$	$V_D = V_{DRM}$ , $R_L = 3.3\text{ k}\Omega$	$T_j = 150\text{ °C}$	Min.	0.2	V
$I_H$	$I_T = 500\text{ mA}$ , gate open		Max.	30	mA
$I_L$	$I_G = 1.2 \times I_{GT}$		Max.	60	mA
$dV/dt$	$V_D = 402\text{ V}$ , gate open	$T_j = 150\text{ °C}$	Min.	1000	$V/\mu s$
$t_{gt}$	$I_T = 32\text{ A}$ , $V_D = 600\text{ V}$ , $I_G = 100\text{ mA}$ , $(dI_G/dt)_{max} = 0.2\text{ A}/\mu s$		Typ.	1.9	$\mu s$
$t_q$	$I_T = 32\text{ A}$ , $V_D = 402\text{ V}$ , $(dI_T/dt)_{OFF} = 30\text{ A}/\mu s$ , $V_R = 25\text{ V}$ , $dV_D/dt = 40\text{ V}/\mu s$		$T_j = 150\text{ °C}$ Typ.	70	$\mu s$

**Table 3. Static characteristics**

Symbol	Test conditions			Value	Unit
$V_{TM}$	$I_T = 32\text{ A}$ , $t_p = 380\ \mu\text{s}$	$T_j = 25\text{ °C}$	Max.	1.60	V
$V_{TO}$	Threshold voltage	$T_j = 150\text{ °C}$	Max.	0.82	
$R_D$	Dynamic resistance	$T_j = 150\text{ °C}$	Max.	25	mΩ
$I_{DRM}$ , $I_{RRM}$	$V_D = V_{DRM}$ ; $V_R = V_{RRM}$	$T_j = 25\text{ °C}$	Max.	5	μA
		$T_j = 150\text{ °C}$		1.5	mA

**Table 4. Thermal parameters**

Symbol	Parameter		Value	Unit
$R_{th(j-c)}$	Junction to case (DC)	Max.	1.1	°C/W
$R_{th(j-a)}$	Junction to ambient (DC)	Typ.	60	

### 1.1 Characteristics curves

**Figure 1. Maximum power dissipation versus average on-state current**

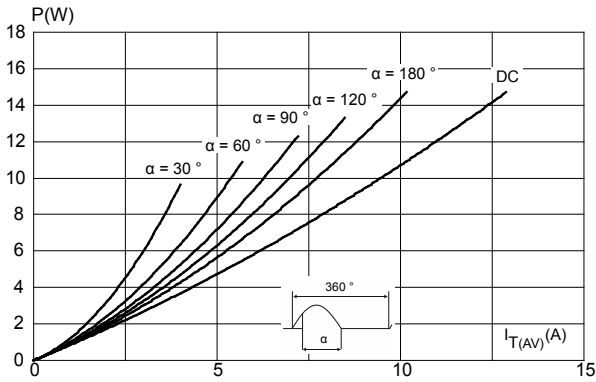

**Figure 2. Average and DC on-state current versus case temperature**

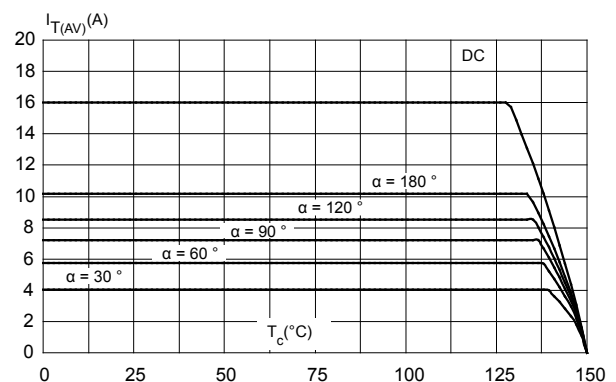

**Figure 3. Average and D.C. on state current versus ambient temperature**

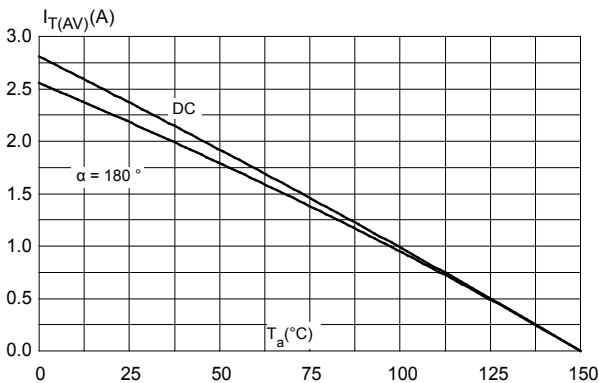

**Figure 4. Relative variation of thermal impedance versus pulse duration**

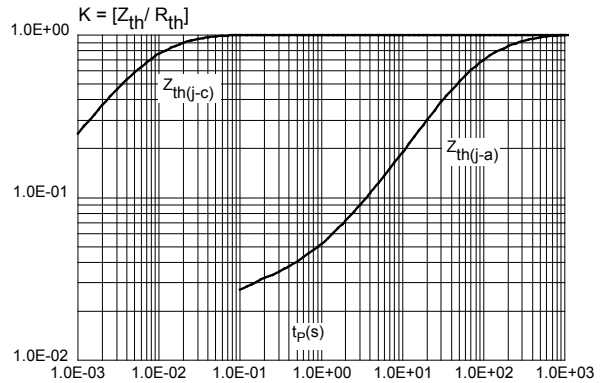

**Figure 5. Relative variation of gate triggering current and gate voltage versus junction temperature (typical values)**

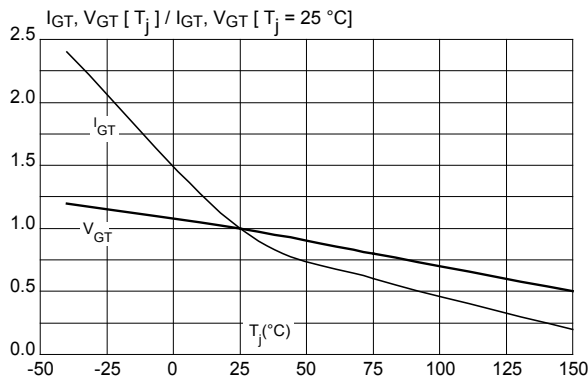

**Figure 6. Relative variation of holding and latching current versus junction temperature (typical values)**

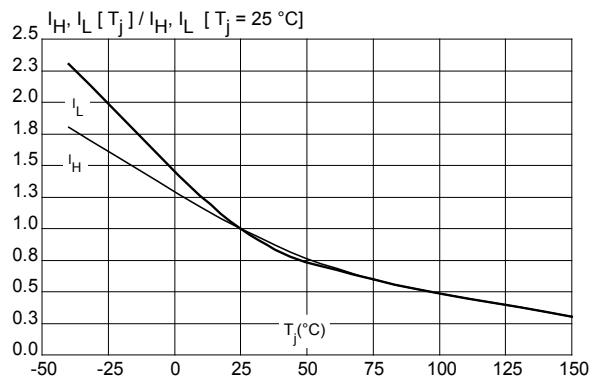

**Figure 7. Relative variation of static dV/dt immunity versus junction temperature (typical values)**

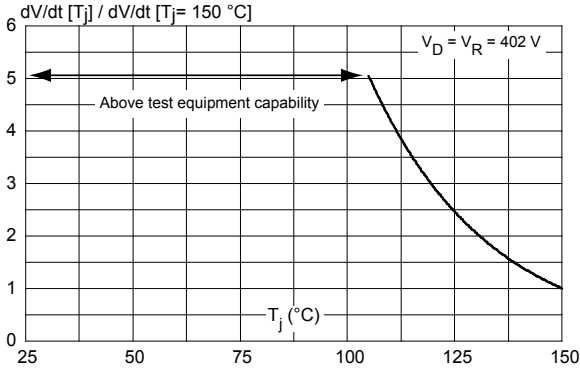

**Figure 8. Surge peak on-state current versus number of cycles**

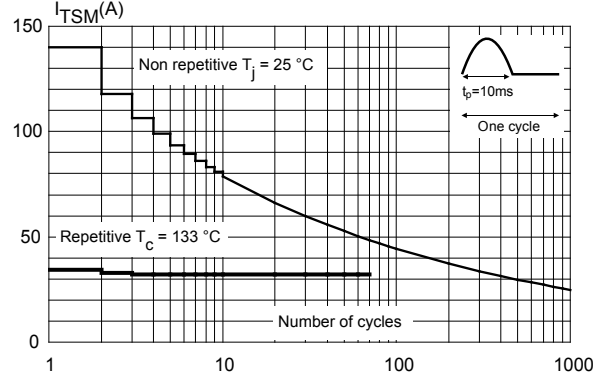

**Figure 9. Non repetitive surge peak on-state current for a sinusoidal pulse with width  $t_p < 10$  ms**

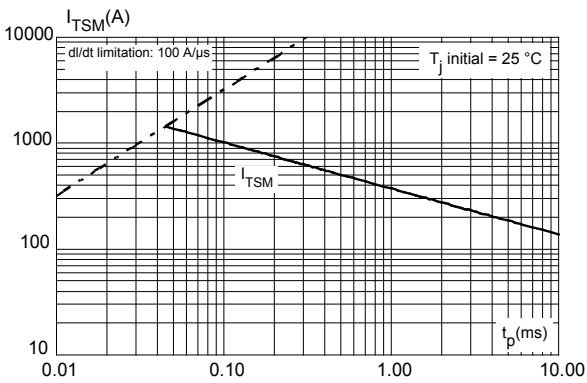

**Figure 10. On-state characteristics (maximum values)**

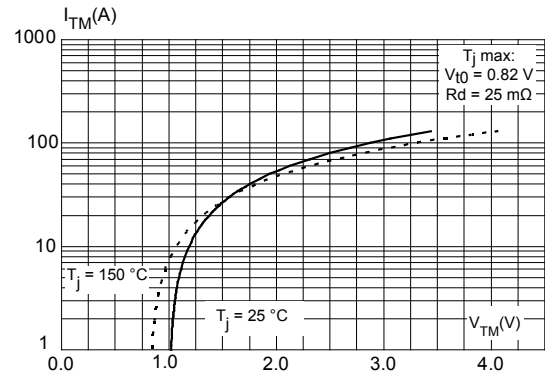

**Figure 11. Relative variation of leakage current versus junction temperature ( $t_p < 10$  ms)**

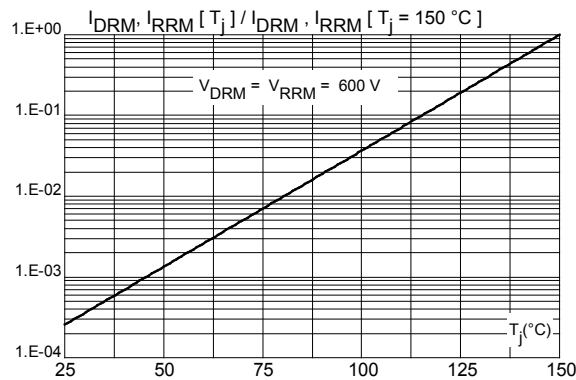

---

## 2 Package information

---

In order to meet environmental requirements, ST offers these devices in different grades of **ECOPACK®** packages, depending on their level of environmental compliance. ECOPACK® specifications, grade definitions and product status are available at: [www.st.com](http://www.st.com). ECOPACK® is an ST trademark.

### 2.1 TO-220AB package information

- Molding compound resin is halogen-free and meets UL standard level V0
- Lead-free package leads finishing
- **ECOPACK®2** compliant
- Recommended torque: 0.4 to 0.6 N.m

Figure 12. TO-220AB insulated package outline

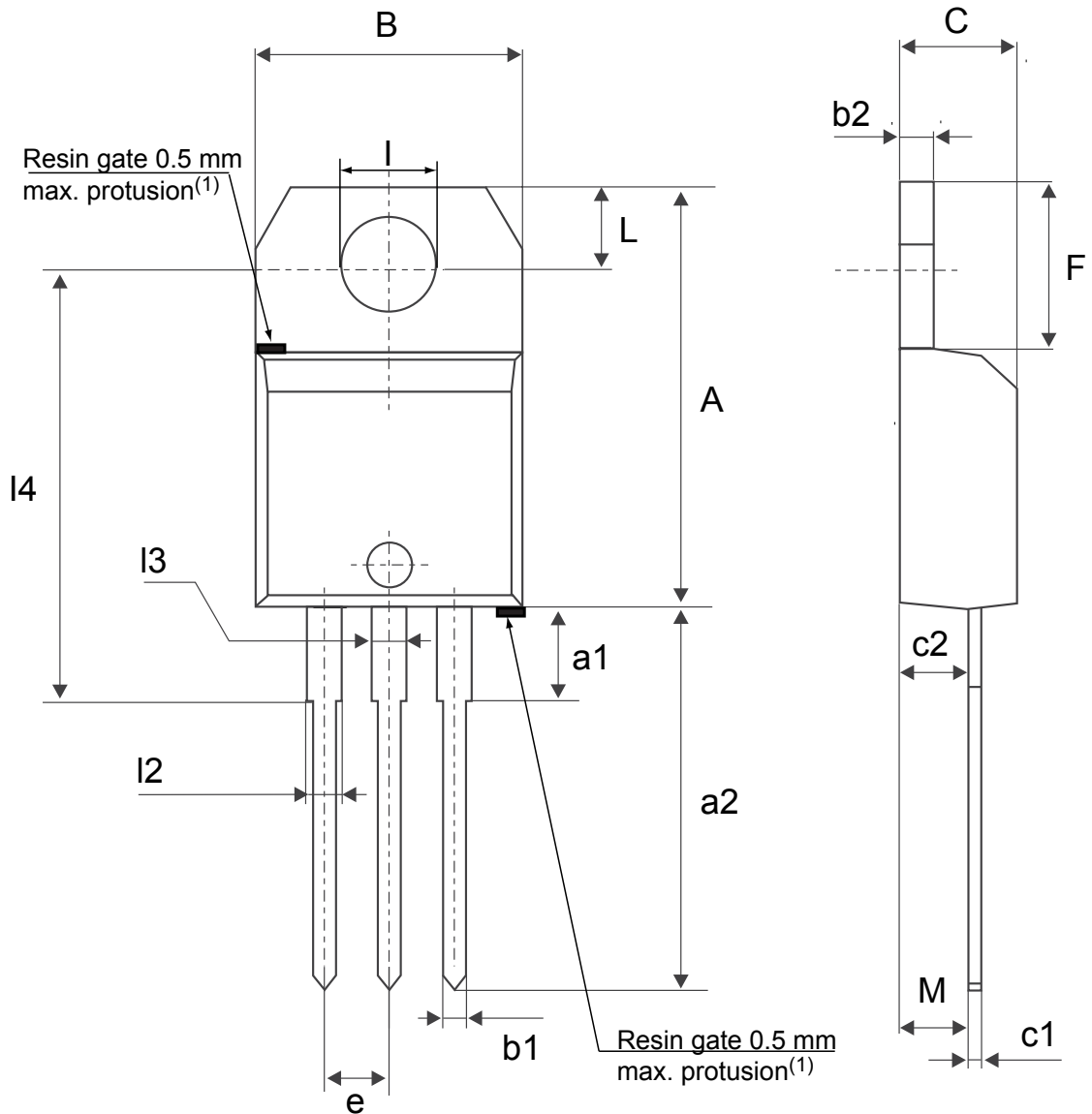

(1) Resin gate position accepted in one of the two positions or in the symmetrical opposites.

**Table 5. TO-220AB insulated package mechanical data**

Ref.	Dimensions					
	Millimeters			Inches <sup>(1)</sup>		
	Min.	Typ.	Max.	Min.	Typ.	Max.
A	15.20		15.90	0.5984		0.6260
a1		3.75			0.1476	
a2	13.00		14.00	0.5118		0.5512
B	10.00		10.40	0.3937		0.4094
b1	0.61		0.88	0.0240		0.0346
b2	1.23		1.32	0.0484		0.0520
C	4.40		4.60	0.1732		0.1811
c1	0.49		0.70	0.0193		0.0276
c2	2.40		2.72	0.0945		0.1071
e	2.40		2.70	0.0945		0.1063
F	6.20		6.60	0.2441		0.2598
l	3.73		3.88	0.1469		0.1528
L	2.65		2.95	0.1043		0.1161
l2	1.14		1.70	0.0449		0.0669
l3	1.14		1.70	0.0449		0.0669
l4	15.80	16.40	16.80	0.6220	0.6457	0.6614
M		2.6			0.1024	

1. Inch dimensions are for reference only.



### 3 Ordering information

Figure 13. Ordering information scheme

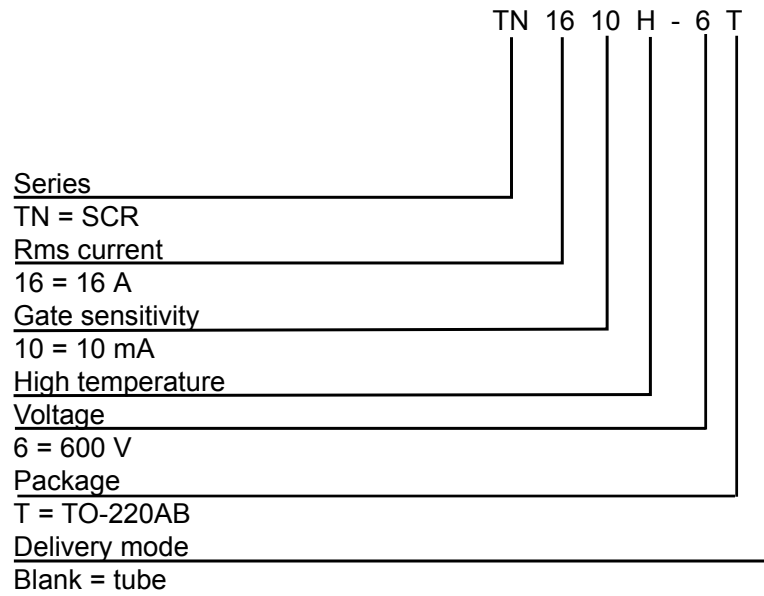

Table 6. Ordering information

Order code	Marking	Package	Weight	Base qty.	Delivery mode
TN1610H-6T	TN1610H6	TO-220AB	2.3 g	50	Tube

## Revision history

**Table 7. Document revision history**

Date	Revision	Changes
24-Feb-2015	1	Initial release.
22-Feb-2019	2	Updated <a href="#">Table 4</a> . Thermal parameters.

**IMPORTANT NOTICE – PLEASE READ CAREFULLY**

STMicroelectronics NV and its subsidiaries (“ST”) reserve the right to make changes, corrections, enhancements, modifications, and improvements to ST products and/or to this document at any time without notice. Purchasers should obtain the latest relevant information on ST products before placing orders. ST products are sold pursuant to ST’s terms and conditions of sale in place at the time of order acknowledgement.

Purchasers are solely responsible for the choice, selection, and use of ST products and ST assumes no liability for application assistance or the design of Purchasers’ products.

No license, express or implied, to any intellectual property right is granted by ST herein.

Resale of ST products with provisions different from the information set forth herein shall void any warranty granted by ST for such product.

ST and the ST logo are trademarks of ST. All other product or service names are the property of their respective owners.

Information in this document supersedes and replaces information previously supplied in any prior versions of this document.

© 2019 STMicroelectronics – All rights reserved