

PTCB E1 24DC/8A NO - Electronic circuit breaker



2909910

<https://www.phoenixcontact.com/us/products/2909910>

Please be informed that the data shown in this PDF document is generated from our Online Catalog. Please find the complete data in the user documentation. Our General Terms of Use for Downloads are valid.

1-channel, electronic circuit breaker for protecting loads at 24 V DC against overload and short circuit. Easy potential distribution with components from the CLIPLINE complete terminal block system. With fixed nominal current. For installation on DIN rails.



Your advantages

- Simple application setup due to bridging option to CLIPLINE complete terminal block system
- More space in the control cabinet: narrowest protection on just 6 mm width
- Individual setup for suitable protection, exactly according to your requirements

Commercial Data

Item number	2909910
Packing unit	1 pc
Minimum order quantity	1 pc
Sales Key	CL10
Product Key	CLA135
Catalog Page	Page 379 (C-4-2019)
GTIN	4055626408774
Weight per Piece (including packing)	44.3 g
Weight per Piece (excluding packing)	27.64 g
Customs tariff number	85363010
Country of origin	DE

Technical Data

Notes

General

Note	
	EN 50121-3-2: Railway applications - Electromagnetic compatibility - Part 3-2: Rolling stock – Apparatus
	Connection for signal line tested in accordance with EN 61000-4-4 with 1 kV; if necessary, customer must provide appropriate protective measures
	Repeated hard short circuits can reduce the melting integral of the integrated backup fuse.

Product properties

Type	DIN rail module, one-piece
Product type	Device circuit breakers
Product family	PTCB
Number of positions	1
No. of channels	1

Insulation characteristics

Protection class	III
Pollution degree	2

Electrical properties

No. of channels	1
-----------------	---

General

Operating voltage	18 V DC ... 30 V DC
Rated voltage	24 V DC
Rated current I_N	24 A DC (Total current input) 8 A DC (Rated current output)
Rated current (pre-adjusted)	8 A
Rated surge voltage	0.5 kV
Tripping method	E (electronic)
Feedback resistance	max. 35 V DC
Required backup fuse	Only required if I_{max} of the power supply > the short-circuit switching capacity. Integrated failsafe element.
Short-circuit switching capacity	300 A
Dielectric strength	max. 35 V DC (Load circuit)
Fuse	electronic
Efficiency	> 99 %
Closed circuit current I_0	typ. 12 mA
Power dissipation	typ. 0.3 W (No-load operation) < 1.6 W (Nominal operation)
Module initialization time	< 0.55 s

PTCB E1 24DC/8A NO - Electronic circuit breaker



2909910

<https://www.phoenixcontact.com/us/products/2909910>

Waiting time after switch off of a channel	5 s (at overload / short circuit)
Measuring tolerance I	± 15 %
Temperature derating	21 A (Total current at 60°C)
	24 A (Total current at 50°C)
	7 A (Channel current at 60°C)
	8 A (Channel current at 50°C)
MTBF (IEC 61709, SN 29500)	25641025 h (at 25 °C with 21 % load)
	10989010 h (at 40°C with 34.25% load)
	1149425 h (at 55°C with 100% load)
Voltage drop	0.13 V (at 8 A)
Fail-safe element	15 A DC

Load circuit

Shutdown time	≤ 10 ms (for short circuit > 2.0 x I _N)
	1 s (1.2 ... 2.0 x I _N)
Undervoltage switch-off	≤ 17.8 V DC (active)
	≥ 18.8 V DC (inactive)
Overvoltage switch-off	≥ 30.5 V DC (active)
	≤ 29.5 V DC (inactive)
Max. capacitive load	25000 µF (Depending on the available short-circuit current)

Indicator/remote signaling

Connection name	Remote indication circuit
Switching function	N/O contact
Operating voltage	0 V DC ... 30 V DC
Operating current	100 mA DC

Connection data

Main circuit IN+

Connection method	Push-in connection
Stripping length	8 mm
Conductor cross section flexible	0.2 mm ² ... 2.5 mm ²
Conductor cross section rigid	0.2 mm ² ... 4 mm ²
Conductor cross section AWG	24 ... 12
Conductor cross section, flexible, with ferrule, with plastic sleeve	0.2 mm ² ... 2.5 mm ²
Conductor cross section flexible, with ferrule without plastic sleeve	0.2 mm ² ... 2.5 mm ²

Main circuit IN-

Connection method	Push-in connection
Stripping length	8 mm
Conductor cross section flexible	0.2 mm ² ... 2.5 mm ²
Conductor cross section rigid	0.2 mm ² ... 4 mm ²
Conductor cross section AWG	24 ... 12
Conductor cross section, flexible, with ferrule, with plastic sleeve	0.2 mm ² ... 2.5 mm ²

PTCB E1 24DC/8A NO - Electronic circuit breaker



2909910

<https://www.phoenixcontact.com/us/products/2909910>

Conductor cross section flexible, with ferrule without plastic sleeve	0.2 mm ² ... 2.5 mm ²
---	---

Main circuit OUT

Connection method	Push-in connection
Stripping length	8 mm
Conductor cross section flexible	0.2 mm ² ... 2.5 mm ²
Conductor cross section rigid	0.2 mm ² ... 4 mm ²
Conductor cross section AWG	24 ... 12
Conductor cross section, flexible, with ferrule, with plastic sleeve	0.2 mm ² ... 2.5 mm ²
Conductor cross section flexible, with ferrule without plastic sleeve	0.2 mm ² ... 2.5 mm ²

Remote indication circuit

Connection method	Push-in connection
Conductor cross section flexible	0.2 mm ² ... 2.5 mm ²
Conductor cross section rigid	0.2 mm ² ... 4 mm ²
Conductor cross section AWG	24 ... 14
Conductor cross section, flexible, with ferrule, with plastic sleeve	0.2 mm ² ... 2.5 mm ²
Conductor cross section flexible, with ferrule without plastic sleeve	0.2 mm ² ... 2.5 mm ²

Signaling

Channel LED off	off (Channel switched off)
Channel LED yellow	lit (Channel switched on, channel load > 80%)
	flashing (Programming mode active)
Channel LED green	lit (Channel switched on)
Channel LED red	lit (Channel switched off, over- or undervoltage active)
	ON temporarily (Channel switched off, 5 s cool-down phase, overload or short-circuit release)
	flashing (Channel switched off, ready to be switched back on, overload or short-circuit release)
	flashing quickly (Channel switched off, external voltage at the output, possible installation error)

Dimensions

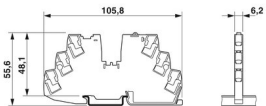
Dimensional drawing	
Width	6.2 mm
Height	105.8 mm
Depth	55.6 mm (incl. DIN rail 7.5 mm)

Material specifications

Material	PBT
----------	-----

2909910

<https://www.phoenixcontact.com/us/products/2909910>

	PBT
Flammability rating according to UL 94	V-0

Environmental and real-life conditions

Ambient conditions

Degree of protection	IP20
Ambient temperature (operation)	-30 °C ... 60 °C
Ambient temperature (storage/transport)	-40 °C ... 70 °C
Altitude	≤ 3000 m up to 52 °C (amsl (above mean sea level))
	≤ 4000 m up to 46 °C (amsl (above mean sea level))
Humidity test	96 h, 95 % RH, 40 °C
Shock (operation)	30g (IEC 60068-2-27, Test Ea)
Vibration (operation)	10 Hz ... 59.6 Hz (Amplitude ±0.35 mm; in accordance with IEC 60068-2-6, Test Fc)
	59.6 Hz ... 150 Hz (Acceleration 5g; in accordance with IEC 60068-2-6, Test Fc)
	5 Hz ... 100 Hz (Resonance search 4g; resonance frequency 4g; 90 min in accordance with DNV GL Class B)

Approvals

UL approval

Identification	UL/C-UL Listed UL 508
	UL Recognized UL 2367
	UL/C-UL Listed ANSI/UL 121201 Class I, Division 2, Groups A, B, C, D; T4 (Hazardous Location)

Shipbuilding approval

Identification	DNV GL
----------------	--------

DNV GL data

Temperature	D
Humidity	B
Vibration	B
EMC	B
Enclosure	A

Standards and regulations

Standards/specifications	EN 61000-6-2
Standards/specifications	EN 61000-6-3
Standards/specifications	EN 60068-2-78
Standards/specifications	EN 50178
Standards/specifications	EN 60068-2-6
Standards/specifications	EN 60068-2-27
Standards/specifications	EN 60068-2-30
Standards/specifications	EN 61373

PTCB E1 24DC/8A NO - Electronic circuit breaker



2909910

<https://www.phoenixcontact.com/us/products/2909910>

Standards/specifications	EN 45545-2
--------------------------	------------

Mounting

Mounting type	DIN rail: 35 mm
---------------	-----------------

PTCB E1 24DC/8A NO - Electronic circuit breaker



2909910

<https://www.phoenixcontact.com/us/products/2909910>

Drawings

Application drawing

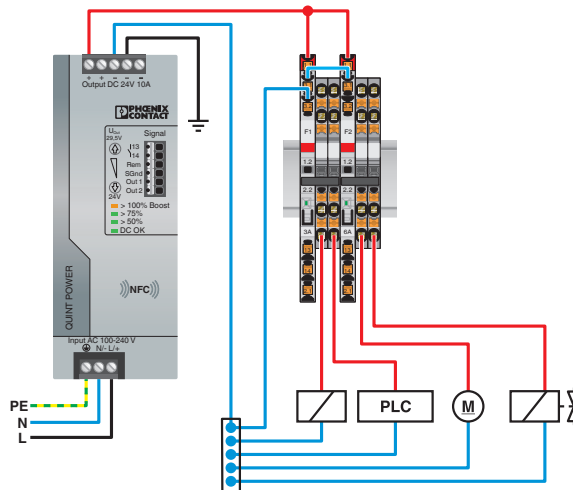

Diagram

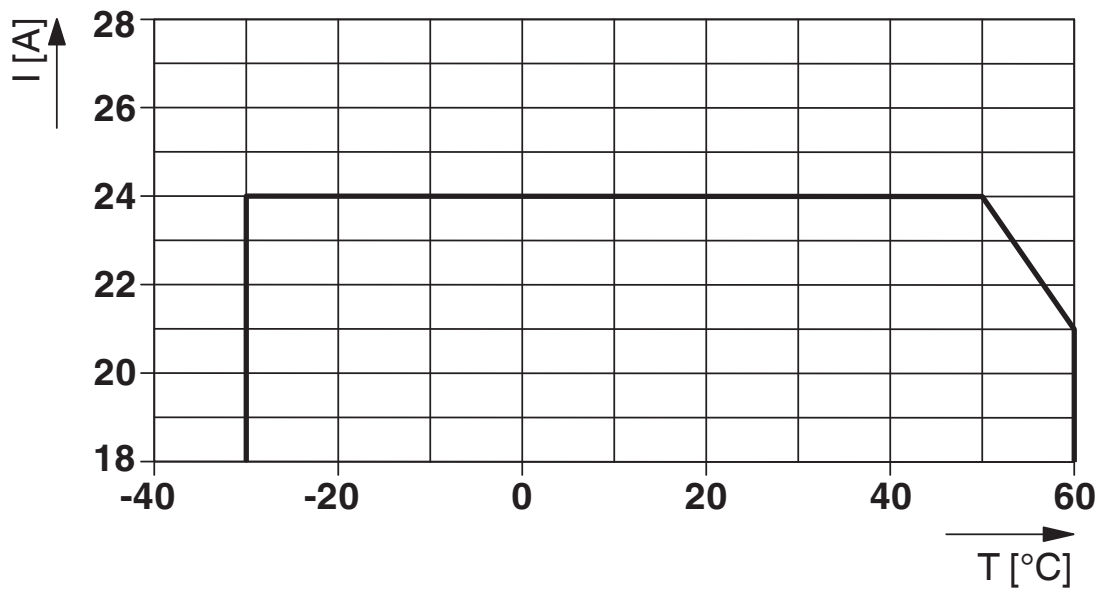

Total current input

PTCB E1 24DC/8A NO - Electronic circuit breaker



2909910

<https://www.phoenixcontact.com/us/products/2909910>

Diagram

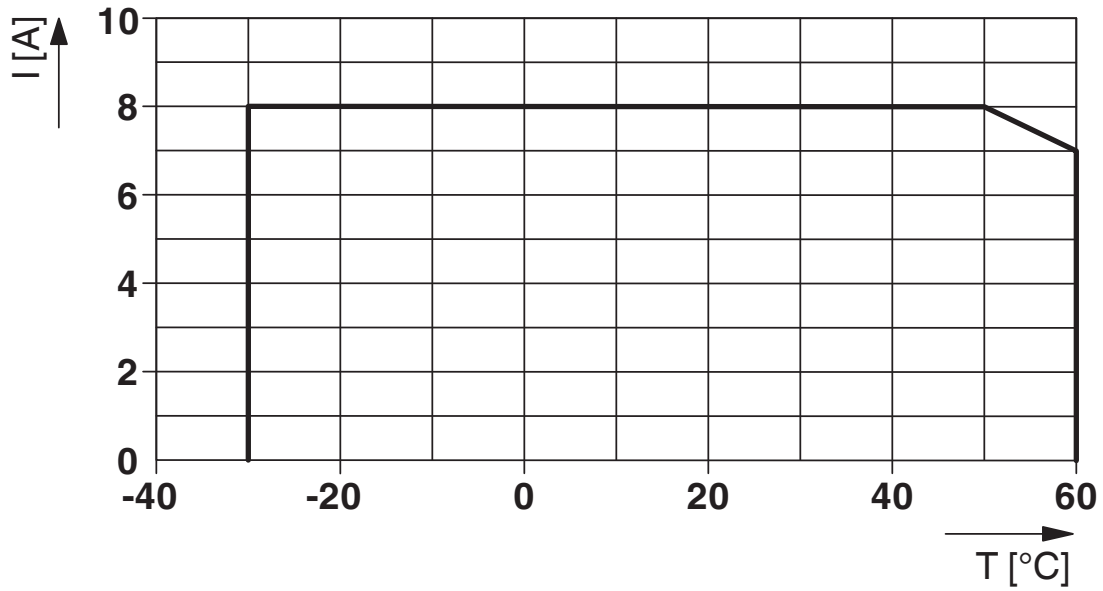

Channel current output

Application drawing

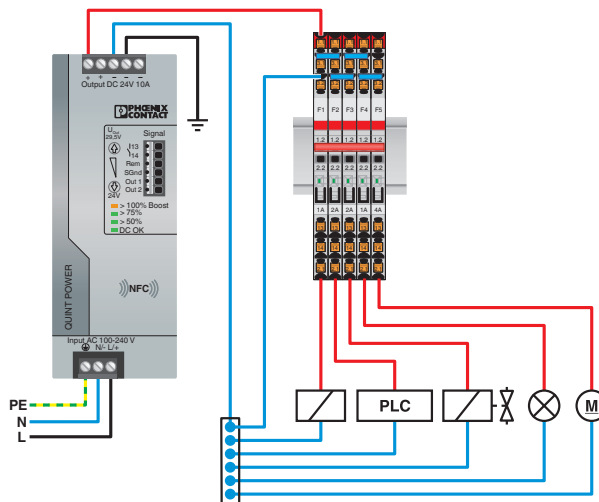

PTCB E1 24DC/8A NO - Electronic circuit breaker



2909910

<https://www.phoenixcontact.com/us/products/2909910>

Block diagram

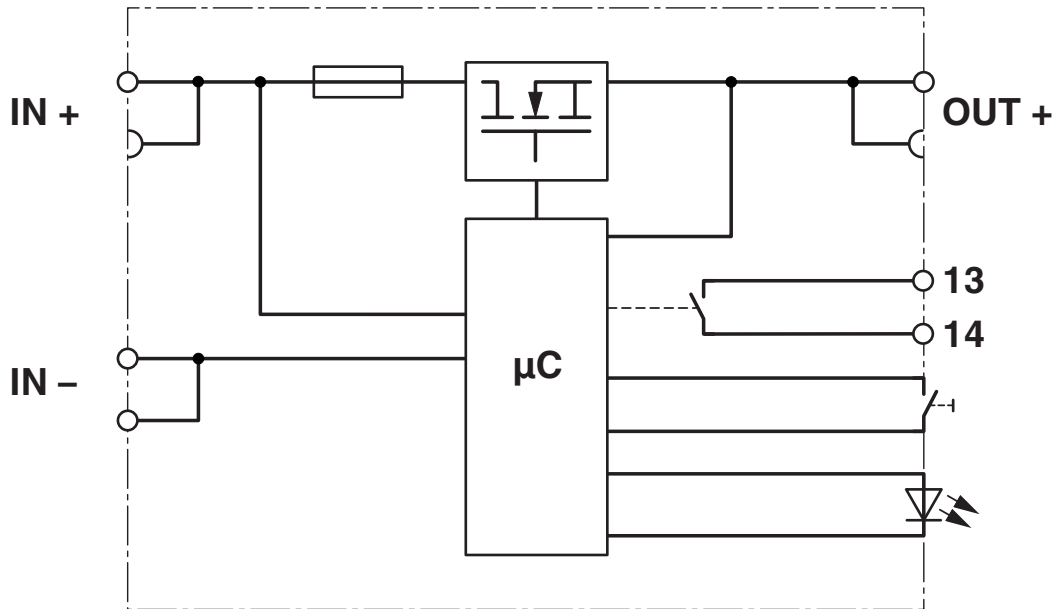

PTCB E1 24DC/8A NO - Electronic circuit breaker



2909910

<https://www.phoenixcontact.com/us/products/2909910>

Product drawing



2909910

<https://www.phoenixcontact.com/us/products/2909910>

Diagram

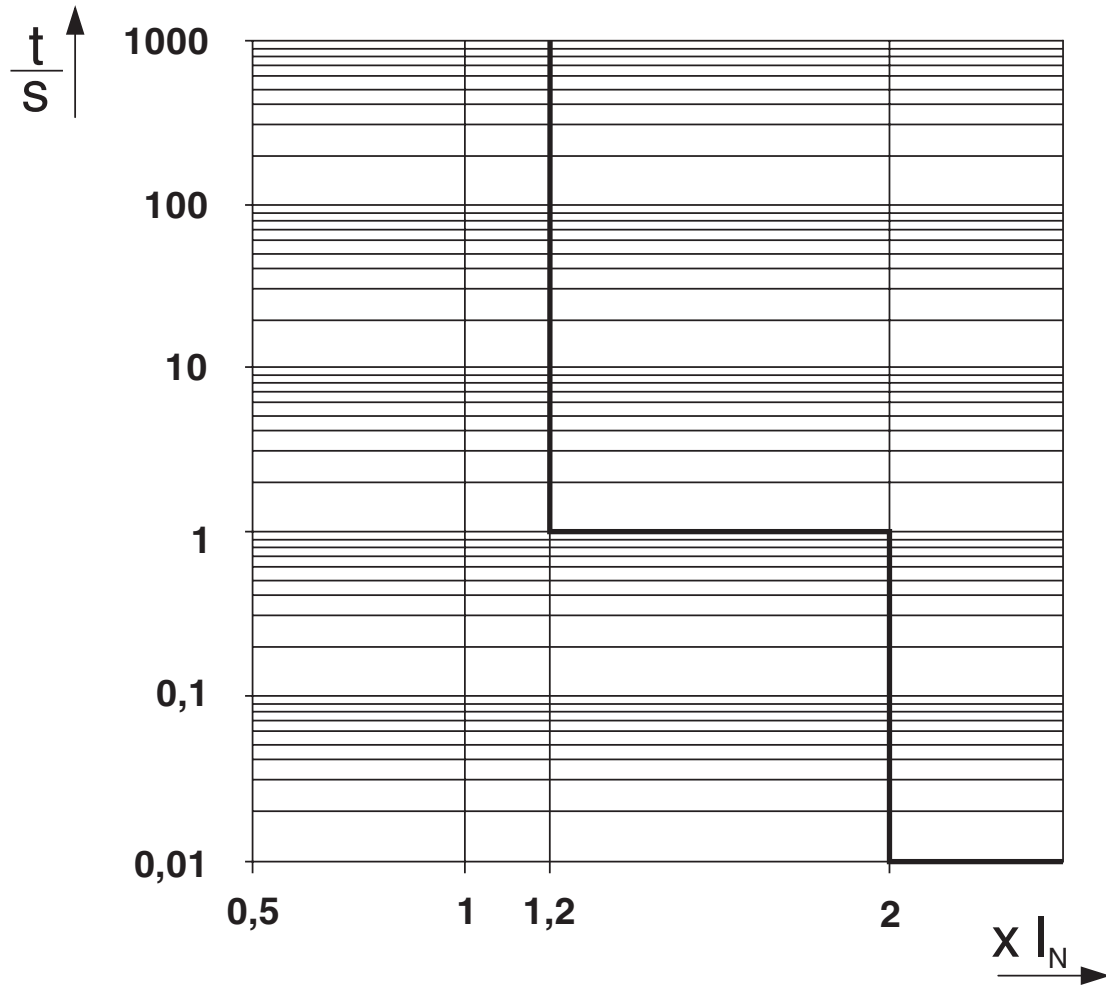

Trigger characteristic in the DC range

Dimensional drawing

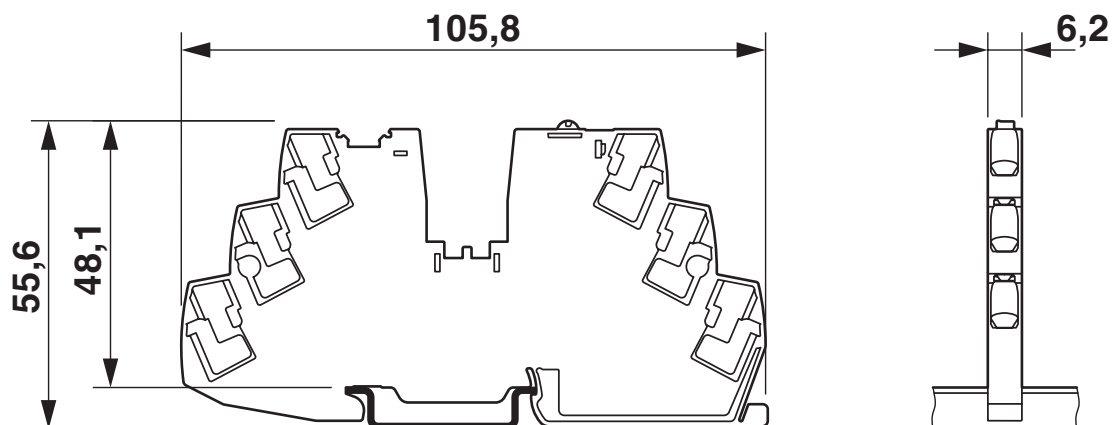

PTCB E1 24DC/8A NO - Electronic circuit breaker



2909910

<https://www.phoenixcontact.com/us/products/2909910>

Approvals



UL Recognized

Approval ID: E317172-20170817



DNV GL

Approval ID: TAE00003UT



UL Listed

Approval ID: E123528-20170530



cUL Listed

Approval ID: E123528-20170530



UL Recognized

Approval ID: E324415-20201030



cUL Listed

Approval ID: E483407-20201030



UL Listed

Approval ID: E483407-20201030

PTCB E1 24DC/8A NO - Electronic circuit breaker



2909910

<https://www.phoenixcontact.com/us/products/2909910>

Classifications

ECLASS

ECLASS-11.0	27140401
ECLASS-12.0	27140401
ECLASS-13.0	27140401

ETIM

ETIM 8.0	EC003538
----------	----------

UNSPSC

UNSPSC 21.0	39121400
-------------	----------

PTCB E1 24DC/8A NO - Electronic circuit breaker



2909910

<https://www.phoenixcontact.com/us/products/2909910>

Environmental Product Compliance

REACH SVHC	Lead 7439-92-1
China RoHS	Environmentally Friendly Use Period = 50 years
	For information on hazardous substances, refer to the manufacturer's declaration available under "Downloads"

PTCB E1 24DC/8A NO - Electronic circuit breaker



2909910

<https://www.phoenixcontact.com/us/products/2909910>

Accessories

 Note: Applying some accessories below might limit this product.

FBS 2-6 - Plug-in bridge

3030336

<https://www.phoenixcontact.com/us/products/3030336>



Plug-in bridge, pitch: 6.2 mm, number of positions: 2, color: red

 Max. current carrying capacity: 32 A

FBS 3-6 - Plug-in bridge

3030242

<https://www.phoenixcontact.com/us/products/3030242>



Plug-in bridge, pitch: 6.2 mm, number of positions: 3, color: red

 Max. current carrying capacity: 32 A

PTCB E1 24DC/8A NO - Electronic circuit breaker



2909910

<https://www.phoenixcontact.com/us/products/2909910>

FBS 4-6 - Plug-in bridge

3030255

<https://www.phoenixcontact.com/us/products/3030255>



Plug-in bridge, pitch: 6.2 mm, number of positions: 4, color: red

 Max. current carrying capacity: 32 A

FBS 5-6 - Plug-in bridge

3030349

<https://www.phoenixcontact.com/us/products/3030349>



Plug-in bridge, pitch: 6.2 mm, number of positions: 5, color: red

 Max. current carrying capacity: 32 A

PTCB E1 24DC/8A NO - Electronic circuit breaker



2909910

<https://www.phoenixcontact.com/us/products/2909910>

FBS 10-6 - Plug-in bridge

3030271

<https://www.phoenixcontact.com/us/products/3030271>

Plug-in bridge, pitch: 6.2 mm, number of positions: 10, color: red



 Max. current carrying capacity: 32 A

FBS 20-6 - Plug-in bridge

3030365

<https://www.phoenixcontact.com/us/products/3030365>

Plug-in bridge, pitch: 6.2 mm, number of positions: 20, color: red



 Max. current carrying capacity: 32 A

PTCB E1 24DC/8A NO - Electronic circuit breaker



2909910

<https://www.phoenixcontact.com/us/products/2909910>

FBS 50-6 - Plug-in bridge

3032224

<https://www.phoenixcontact.com/us/products/3032224>



Plug-in bridge, pitch: 6.2 mm, number of positions: 50, color: red

 Max. current carrying capacity: 32 A

FBS 2-6 BU - Plug-in bridge

3036932

<https://www.phoenixcontact.com/us/products/3036932>



Plug-in bridge, pitch: 6.2 mm, number of positions: 2, color: blue

 Max. current carrying capacity: 32 A

PTCB E1 24DC/8A NO - Electronic circuit breaker



2909910

<https://www.phoenixcontact.com/us/products/2909910>

FBS 3-6 BU - Plug-in bridge

3036945

<https://www.phoenixcontact.com/us/products/3036945>



Plug-in bridge, pitch: 6.2 mm, number of positions: 3, color: blue

 Max. current carrying capacity: 32 A

FBS 4-6 BU - Plug-in bridge

3036958

<https://www.phoenixcontact.com/us/products/3036958>



Plug-in bridge, pitch: 6.2 mm, number of positions: 4, color: blue

 Max. current carrying capacity: 32 A

PTCB E1 24DC/8A NO - Electronic circuit breaker



2909910

<https://www.phoenixcontact.com/us/products/2909910>

FBS 5-6 BU - Plug-in bridge

3036961

<https://www.phoenixcontact.com/us/products/3036961>



Plug-in bridge, pitch: 6.2 mm, number of positions: 5, color: blue

 Max. current carrying capacity: 32 A

FBS 10-6 BU - Plug-in bridge

3032198

<https://www.phoenixcontact.com/us/products/3032198>



Plug-in bridge, pitch: 6.2 mm, number of positions: 10, color: blue

 Max. current carrying capacity: 32 A

PTCB E1 24DC/8A NO - Electronic circuit breaker



2909910

<https://www.phoenixcontact.com/us/products/2909910>

FBS 20-6 BU - Plug-in bridge

3032208

<https://www.phoenixcontact.com/us/products/3032208>

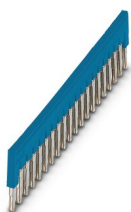

Plug-in bridge, pitch: 6.2 mm, number of positions: 20, color: blue

 Max. current carrying capacity: 32 A

FBS 50-6 BU - Plug-in bridge

3032211

<https://www.phoenixcontact.com/us/products/3032211>



Plug-in bridge, pitch: 6.2 mm, number of positions: 50, color: blue

 Max. current carrying capacity: 32 A

PTCB E1 24DC/8A NO - Electronic circuit breaker



2909910

<https://www.phoenixcontact.com/us/products/2909910>

FBS 2-6 GY - Plug-in bridge

3032237

<https://www.phoenixcontact.com/us/products/3032237>



Plug-in bridge, pitch: 6.2 mm, number of positions: 2, color: gray

 Max. current carrying capacity: 32 A

FBS 3-6 GY - Plug-in bridge

3032240

<https://www.phoenixcontact.com/us/products/3032240>



Plug-in bridge, pitch: 6.2 mm, number of positions: 3, color: gray

 Max. current carrying capacity: 32 A

PTCB E1 24DC/8A NO - Electronic circuit breaker



2909910

<https://www.phoenixcontact.com/us/products/2909910>

FBS 4-6 GY - Plug-in bridge

3032279

<https://www.phoenixcontact.com/us/products/3032279>



Plug-in bridge, pitch: 6.2 mm, number of positions: 4, color: gray

 Max. current carrying capacity: 32 A

FBS 5-6 GY - Plug-in bridge

3032266

<https://www.phoenixcontact.com/us/products/3032266>



Plug-in bridge, pitch: 6.2 mm, number of positions: 5, color: gray

 Max. current carrying capacity: 32 A

PTCB E1 24DC/8A NO - Electronic circuit breaker



2909910

<https://www.phoenixcontact.com/us/products/2909910>

FBS 2-5 - Plug-in bridge

3030161

<https://www.phoenixcontact.com/us/products/3030161>



Plug-in bridge, pitch: 5.2 mm, number of positions: 2, length: 23 mm, color: red

 Max. current carrying capacity: 24 A

FBS 3-5 - Plug-in bridge

3030174

<https://www.phoenixcontact.com/us/products/3030174>



Plug-in bridge, pitch: 5.2 mm, number of positions: 3, length: 23 mm, color: red

 Max. current carrying capacity: 24 A

PTCB E1 24DC/8A NO - Electronic circuit breaker



2909910

<https://www.phoenixcontact.com/us/products/2909910>

FBS 4-5 - Plug-in bridge

3030187

<https://www.phoenixcontact.com/us/products/3030187>



Plug-in bridge, pitch: 5.2 mm, number of positions: 4, length: 23 mm, color: red

 Max. current carrying capacity: 24 A

FBS 5-5 - Plug-in bridge

3030190

<https://www.phoenixcontact.com/us/products/3030190>



Plug-in bridge, pitch: 5.2 mm, number of positions: 5, length: 23 mm, color: red

 Max. current carrying capacity: 24 A

PTCB E1 24DC/8A NO - Electronic circuit breaker



2909910

<https://www.phoenixcontact.com/us/products/2909910>

FBS 10-5 - Plug-in bridge

3030213

<https://www.phoenixcontact.com/us/products/3030213>



Plug-in bridge, pitch: 5.2 mm, number of positions: 10, length: 23 mm, color: red

 Max. current carrying capacity: 24 A

FBS 20-5 - Plug-in bridge

3030226

<https://www.phoenixcontact.com/us/products/3030226>



Plug-in bridge, pitch: 5.2 mm, number of positions: 20, color: red

 Max. current carrying capacity: 24 A

PTCB E1 24DC/8A NO - Electronic circuit breaker



2909910

<https://www.phoenixcontact.com/us/products/2909910>

FBS 50-5 - Plug-in bridge

3038930

<https://www.phoenixcontact.com/us/products/3038930>



Plug-in bridge, pitch: 5.2 mm, number of positions: 50, color: red

 Max. current carrying capacity: 24 A

FBS 2-5 BU - Plug-in bridge

3036877

<https://www.phoenixcontact.com/us/products/3036877>



Plug-in bridge, pitch: 5.2 mm, number of positions: 2, color: blue

 Max. current carrying capacity: 24 A

PTCB E1 24DC/8A NO - Electronic circuit breaker



2909910

<https://www.phoenixcontact.com/us/products/2909910>

FBS 3-5 BU - Plug-in bridge

3036880

<https://www.phoenixcontact.com/us/products/3036880>



Plug-in bridge, pitch: 5.2 mm, number of positions: 3, color: blue

 Max. current carrying capacity: 24 A

FBS 4-5 BU - Plug-in bridge

3036893

<https://www.phoenixcontact.com/us/products/3036893>



Plug-in bridge, pitch: 5.2 mm, number of positions: 4, color: blue

 Max. current carrying capacity: 24 A

PTCB E1 24DC/8A NO - Electronic circuit breaker



2909910

<https://www.phoenixcontact.com/us/products/2909910>

FBS 5-5 BU - Plug-in bridge

3036903

<https://www.phoenixcontact.com/us/products/3036903>



Plug-in bridge, pitch: 5.2 mm, number of positions: 5, color: blue

 Max. current carrying capacity: 24 A

FBS 10-5 BU - Plug-in bridge

3036916

<https://www.phoenixcontact.com/us/products/3036916>



Plug-in bridge, pitch: 5.2 mm, number of positions: 10, color: blue

 Max. current carrying capacity: 24 A

PTCB E1 24DC/8A NO - Electronic circuit breaker

2909910

<https://www.phoenixcontact.com/us/products/2909910>

FBS 20-5 BU - Plug-in bridge

3036929

<https://www.phoenixcontact.com/us/products/3036929>



Plug-in bridge, pitch: 5.2 mm, number of positions: 20, color: blue

 Max. current carrying capacity: 24 A

FBS 50-5 BU - Plug-in bridge

3032114

<https://www.phoenixcontact.com/us/products/3032114>



Plug-in bridge, pitch: 5.2 mm, number of positions: 50, color: blue

 Max. current carrying capacity: 24 A

PTCB E1 24DC/8A NO - Electronic circuit breaker



2909910

<https://www.phoenixcontact.com/us/products/2909910>

FBS 2-5 GY - Plug-in bridge

3038969

<https://www.phoenixcontact.com/us/products/3038969>



Plug-in bridge, pitch: 5.2 mm, number of positions: 2, color: gray

 Max. current carrying capacity: 24 A

FBS 3-5 GY - Plug-in bridge

3038972

<https://www.phoenixcontact.com/us/products/3038972>



Plug-in bridge, pitch: 5.2 mm, number of positions: 3, color: gray

 Max. current carrying capacity: 24 A

PTCB E1 24DC/8A NO - Electronic circuit breaker



2909910

<https://www.phoenixcontact.com/us/products/2909910>

FBS 4-5 GY - Plug-in bridge

3038985

<https://www.phoenixcontact.com/us/products/3038985>



Plug-in bridge, pitch: 5.2 mm, number of positions: 4, color: gray

 Max. current carrying capacity: 24 A

FBS 5-5 GY - Plug-in bridge

3038998

<https://www.phoenixcontact.com/us/products/3038998>



Plug-in bridge, pitch: 5.2 mm, number of positions: 5, color: gray

 Max. current carrying capacity: 24 A

PTCB E1 24DC/8A NO - Electronic circuit breaker



2909910

<https://www.phoenixcontact.com/us/products/2909910>

RB ST 10-(2,5/4) - Reducing bridge

3030873

<https://www.phoenixcontact.com/us/products/3030873>



Reducing bridge, pitch: 10 mm, number of positions: 2, length: 36 mm, color: red

PT 4 - Feed-through terminal block

3211757

<https://www.phoenixcontact.com/us/products/3211757>

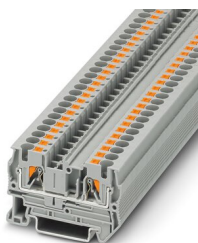

Feed-through terminal block, nom. voltage: 800 V, nominal current: 32 A, connection method: Push-in connection, Rated cross section: 4 mm², cross section: 0.2 mm² - 6 mm², mounting type: NS 35/7,5, NS 35/15, color: gray

PTCB E1 24DC/8A NO - Electronic circuit breaker



2909910

<https://www.phoenixcontact.com/us/products/2909910>

PT 4-TWIN - Feed-through terminal block

3211771

<https://www.phoenixcontact.com/us/products/3211771>



Feed-through terminal block, nom. voltage: 800 V, nominal current: 32 A, connection method: Push-in connection, Rated cross section: 4 mm², cross section: 0.2 mm² - 6 mm², mounting type: NS 35/7,5, NS 35/15, color: gray

PT 4-QUATTRO - Feed-through terminal block

3211797

<https://www.phoenixcontact.com/us/products/3211797>



Feed-through terminal block, nom. voltage: 800 V, nominal current: 32 A, connection method: Push-in connection, Rated cross section: 4 mm², cross section: 0.2 mm² - 6 mm², mounting type: NS 35/7,5, NS 35/15, color: gray

PTCB E1 24DC/8A NO - Electronic circuit breaker



2909910

<https://www.phoenixcontact.com/us/products/2909910>

ST 4 - Feed-through terminal block

3031364

<https://www.phoenixcontact.com/us/products/3031364>

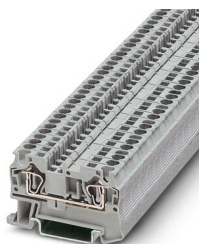

Feed-through terminal block, nom. voltage: 800 V, nominal current: 32 A, connection method: Spring-cage connection, 1 level, Rated cross section: 4 mm², cross section: 0.08 mm² - 6 mm², mounting type: NS 35/7,5, NS 35/15, color: gray

ST 4-TWIN - Feed-through terminal block

3031393

<https://www.phoenixcontact.com/us/products/3031393>

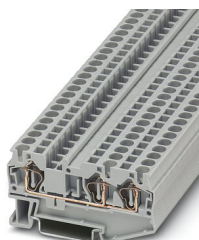

Feed-through terminal block, nom. voltage: 800 V, nominal current: 32 A, connection method: Spring-cage connection, Rated cross section: 4 mm², cross section: 0.08 mm² - 6 mm², mounting type: NS 35/7,5, NS 35/15, color: gray

PTCB E1 24DC/8A NO - Electronic circuit breaker



2909910

<https://www.phoenixcontact.com/us/products/2909910>

ST 4-QUATTRO - Feed-through terminal block

3031445

<https://www.phoenixcontact.com/us/products/3031445>



Feed-through terminal block, nom. voltage: 800 V, nominal current: 32 A, connection method: Spring-cage connection, 1 level, Rated cross section: 4 mm², cross section: 0.08 mm² - 6 mm², mounting type: NS 35/7,5, NS 35/15, color: gray

QTC 2,5 - Feed-through terminal block

3206416

<https://www.phoenixcontact.com/us/products/3206416>

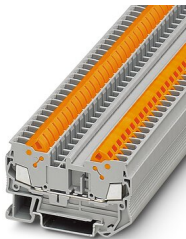

Feed-through terminal block, nom. voltage: 800 V, nominal current: 24 A, connection method: Quick connection, 1 level, Rated cross section: 2.5 mm², cross section: 0.5 mm² - 2.5 mm², mounting type: NS 35/7,5, NS 35/15, color: gray

PTCB E1 24DC/8A NO - Electronic circuit breaker



2909910

<https://www.phoenixcontact.com/us/products/2909910>

QTC 2,5-TWIN - Feed-through terminal block

3206445

<https://www.phoenixcontact.com/us/products/3206445>

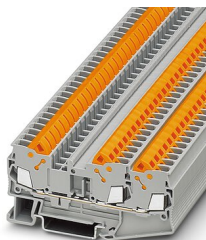

Feed-through terminal block, nom. voltage: 800 V, nominal current: 24 A, connection method: Quick connection, 1 level, Rated cross section: 2.5 mm², cross section: 0.5 mm² - 2.5 mm², mounting type: NS 35/7,5, NS 35/7,5, color: gray

QTC 2,5-QUATTRO - Feed-through terminal block

3206446

<https://www.phoenixcontact.com/us/products/3206446>

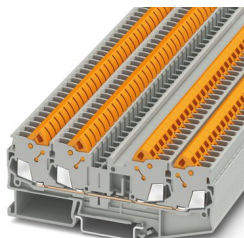

Feed-through terminal block, nom. voltage: 800 V, nominal current: 24 A, connection method: Quick connection, 1 level, Rated cross section: 2.5 mm², cross section: 0.5 mm² - 2.5 mm², mounting type: NS 35/7,5, NS 35/7,5, color: gray

PTCB E1 24DC/8A NO - Electronic circuit breaker



2909910

<https://www.phoenixcontact.com/us/products/2909910>

PT 2,5 - Feed-through terminal block

3209510

<https://www.phoenixcontact.com/us/products/3209510>



Feed-through terminal block, nom. voltage: 800 V, nominal current: 24 A, connection method: Push-in connection, Rated cross section: 2.5 mm², cross section: 0.14 mm² - 4 mm², mounting type: NS 35/7,5, NS 35/15, color: gray

PT 2,5-TWIN - Feed-through terminal block

3209549

<https://www.phoenixcontact.com/us/products/3209549>

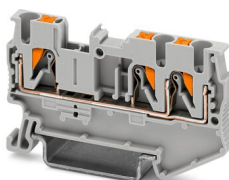

Feed-through terminal block, nom. voltage: 800 V, nominal current: 24 A, connection method: Push-in connection, Rated cross section: 2.5 mm², cross section: 0.14 mm² - 4 mm², mounting type: NS 35/7,5, NS 35/15, color: gray

PTCB E1 24DC/8A NO - Electronic circuit breaker



2909910

<https://www.phoenixcontact.com/us/products/2909910>

PT 2,5-QUATTRO - Feed-through terminal block

3209578

<https://www.phoenixcontact.com/us/products/3209578>

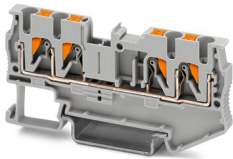

Feed-through terminal block, nom. voltage: 800 V, nominal current: 24 A, connection method: Push-in connection, Rated cross section: 2.5 mm², cross section: 0.14 mm² - 4 mm², mounting type: NS 35/7,5, NS 35/15, color: gray

ST 2,5 - Feed-through terminal block

3031212

<https://www.phoenixcontact.com/us/products/3031212>



Feed-through terminal block, nom. voltage: 800 V, nominal current: 24 A, connection method: Spring-cage connection, Rated cross section: 2.5 mm², cross section: 0.08 mm² - 4 mm², mounting type: NS 35/7,5, NS 35/15, color: gray

PTCB E1 24DC/8A NO - Electronic circuit breaker



2909910

<https://www.phoenixcontact.com/us/products/2909910>

ST 2,5-TWIN - Feed-through terminal block

3031241

<https://www.phoenixcontact.com/us/products/3031241>

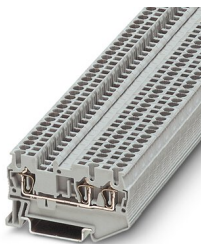

Feed-through terminal block, nom. voltage: 800 V, nominal current: 24 A, connection method: Spring-cage connection, Rated cross section: 2.5 mm², cross section: 0.08 mm² - 4 mm², mounting type: NS 35/7,5, NS 35/15, color: gray

ST 2,5-QUATTRO - Feed-through terminal block

3031306

<https://www.phoenixcontact.com/us/products/3031306>

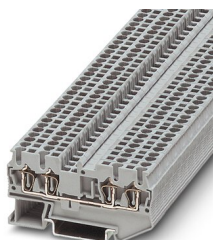

Feed-through terminal block, nom. voltage: 800 V, nominal current: 24 A, connection method: Spring-cage connection, Rated cross section: 2.5 mm², cross section: 0.08 mm² - 4 mm², mounting type: NS 35/7,5, NS 35/15, color: gray

PTCB E1 24DC/8A NO - Electronic circuit breaker



2909910

<https://www.phoenixcontact.com/us/products/2909910>

QTC 1,5 - Feed-through terminal block

3205019

<https://www.phoenixcontact.com/us/products/3205019>

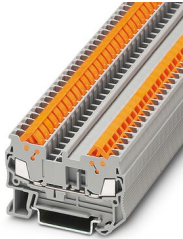

Feed-through terminal block, nom. voltage: 800 V, nominal current: 17.5 A, connection method: Quick connection, 1 level, Rated cross section: 1.5 mm², cross section: 0.25 mm² - 1.5 mm², mounting type: NS 35/7,5, NS 35/15, color: gray

QTC 1,5-TWIN - Feed-through terminal block

3205048

<https://www.phoenixcontact.com/us/products/3205048>

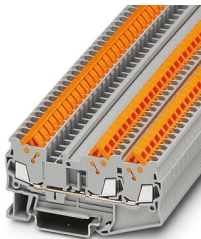

Feed-through terminal block, nom. voltage: 800 V, nominal current: 17.5 A, connection method: Quick connection, 1 level, Rated cross section: 1.5 mm², cross section: 0.25 mm² - 1.5 mm², mounting type: NS 35/7,5, NS 35/7,5, color: gray

PTCB E1 24DC/8A NO - Electronic circuit breaker



2909910

<https://www.phoenixcontact.com/us/products/2909910>

QTC 1,5-QUATTRO - Feed-through terminal block

3205077

<https://www.phoenixcontact.com/us/products/3205077>



Feed-through terminal block, nom. voltage: 800 V, nominal current: 17.5 A, connection method: Quick connection, 1 level, Rated cross section: 1.5 mm², cross section: 0.25 mm² - 1.5 mm², mounting type: NS 35/7,5, NS 35/7,5, color: gray

PT 10 - Feed-through terminal block

3212120

<https://www.phoenixcontact.com/us/products/3212120>

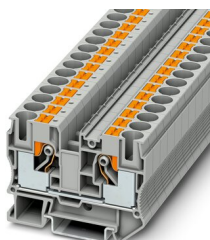

Feed-through terminal block, nom. voltage: 1000 V, nominal current: 57 A, connection method: Push-in connection, Rated cross section: 10 mm², cross section: 0.5 mm² - 16 mm², mounting type: NS 35/7,5, NS 35/15, color: gray

PTCB E1 24DC/8A NO - Electronic circuit breaker



2909910

<https://www.phoenixcontact.com/us/products/2909910>

ST 10 - Feed-through terminal block

3036110

<https://www.phoenixcontact.com/us/products/3036110>



Feed-through terminal block, nom. voltage: 1000 V, nominal current: 57 A, connection method: Spring-cage connection, Rated cross section: 10 mm², cross section: 0.2 mm² - 16 mm², mounting type: NS 35/7,5, NS 35/15, color: gray

ZB 6:UNBEDRUCKT - Zack marker strip

1051003

<https://www.phoenixcontact.com/us/products/1051003>



Zack marker strip, Strip, white, unlabeled, can be labeled with: PLOTMARK, CMS-P1-PLOTTER, mounting type: snapped, for terminal block width: 6.2 mm, lettering field size: 6.15 x 10.5 mm, Number of individual labels: 10

PTCB E1 24DC/8A NO - Electronic circuit breaker



2909910

<https://www.phoenixcontact.com/us/products/2909910>

ZBF 6:UNBEDRUCKT - Zack Marker strip, flat

0808710

<https://www.phoenixcontact.com/us/products/0808710>



Zack Marker strip, flat, Strip, white, unlabeled, can be labeled with: PLOTMARK, CMS-P1-PLOTTER, mounting type: snapped, for terminal block width: 6.2 mm, lettering field size: 5.15 x 6.15 mm, Number of individual labels: 10

UCT-TM 6 - Marker for terminal blocks

0828736

<https://www.phoenixcontact.com/us/products/0828736>



Marker for terminal blocks, Sheet, white, unlabeled, can be labeled with: TOPMARK NEO, TOPMARK LASER, BLUEMARK ID COLOR, BLUEMARK ID, BLUEMARK CLED, THERMOMARK PRIME, THERMOMARK CARD 2.0, THERMOMARK CARD, mounting type: snapped, for terminal block width: 6.2 mm, lettering field size: 5.6 x 10.5 mm, Number of individual labels: 60

PTCB E1 24DC/8A NO - Electronic circuit breaker



2909910

<https://www.phoenixcontact.com/us/products/2909910>

UCT-TM 6 CUS - Marker for terminal blocks

0829602

<https://www.phoenixcontact.com/us/products/0829602>



Marker for terminal blocks, can be ordered: by sheet, white, labeled according to customer specifications, mounting type: snap into tall marker groove, for terminal block width: 6.2 mm, lettering field size: 5.6 x 10.5 mm, Number of individual labels: 60

US-TML (104X3,8) - Marker for terminal blocks

0830768

<https://www.phoenixcontact.com/us/products/0830768>



Marker for terminal blocks, Card, white, unlabeled, can be labeled with: BLUEMARK ID COLOR, BLUEMARK ID, THERMOMARK PRIME, THERMOMARK CARD 2.0, THERMOMARK CARD, mounting type: adhesive, lettering field size: 104 x 3.8 mm, Number of individual labels: 22

PTCB E1 24DC/8A NO - Electronic circuit breaker

2909910

<https://www.phoenixcontact.com/us/products/2909910>



TTC-6P-T3-24DC-PT-I - Type 3 surge protection device

1027586

<https://www.phoenixcontact.com/us/products/1027586>



Type 3 surge protection, consisting of protective plug and base element, with integrated status indicator for 24 V DC power supplies

DB 50- 90 BK - Wire bridge

2820916

<https://www.phoenixcontact.com/us/products/2820916>

Flexible wire loop bridge, 50-pos., conductor cross-section: 0.5 mm², loop length: 90 mm, ferrule length: 8 mm, color: black



PTCB E1 24DC/8A NO - Electronic circuit breaker



2909910

<https://www.phoenixcontact.com/us/products/2909910>

DB 50- 90 BU - Wire bridge

2821180

<https://www.phoenixcontact.com/us/products/2821180>

Flexible wire loop bridge, 50-pos., conductor cross-section: 0.5 mm², loop length: 90 mm, ferrule length: 8 mm, color: blue



DB 50- 90 GY - Wire bridge

2820929

<https://www.phoenixcontact.com/us/products/2820929>

Flexible wire loop bridge, 50-pos., conductor cross-section: 0.5 mm², loop length: 90 mm, ferrule length: 8 mm, color: gray



PTCB E1 24DC/8A NO - Electronic circuit breaker



2909910

<https://www.phoenixcontact.com/us/products/2909910>

DB 50- 90 RD - Wire bridge

2864639

<https://www.phoenixcontact.com/us/products/2864639>

Flexible wire loop bridge, 50-pos., conductor cross-section: 0.5 mm², loop length: 90 mm, ferrule length: 8 mm, color: red



Phoenix Contact 2023 © - all rights reserved

<https://www.phoenixcontact.com>

Phoenix Contact USA
586 Fulling Mill Road
Middletown, PA 17057, United States
(+717) 944-1300
info@phoenixcon.com