

SaBLE-x™ *Bluetooth*® Smart (BLE) Module

FEATURES

- Built in CC2640F128 Bluetooth Smart (BLE 4.1) System-On-Chip (SOC)
- 128 kB Flash / 20 kB SRAM
- RF Output Power: +5 dBm
- RF Receive Sensitivity: -97 dBm
- Size: 11.6mm x17.9mm x 2.3mm
- Operating Voltage: 1.8V to 3.8V
- Operating Temperature: -40 to +85C
- 9.1mA Transmit Mode (+5 dBm)
- 6.1mA Receive Mode
- 1µA Standby (SRAM/CPU retention and RTC running) with quick 100 µs start up
- 200nA Shutdown
- 61µA/MHz Active CPU Current
- Drivers, Bluetooth Low Energy Controller, IEEE 802.15.4 MAC and bootloader in ROM
- Flexible peripheral set
- On board Sensor Controller Engine
- On board 32 kHz and 24 MHz Crystals.
- Worldwide Acceptance: FCC (USA), IC (Canada), ETSI (Europe), Giteki (Japan), C-Tick (AU/NZ) All Pending
- REACH and RoHS compliant

APPLICATIONS

- Consumer electronics
- Mobile phone accessories
- Sports & Fitness equipment
- HID applications
- Home and Building Automation, Lighting Control, Alarm and Security
- Electronic Shelf Labeling, Proximity Tags

DESCRIPTION

LSR would like to announce a low-cost and low-power consumption module which has all of the *Bluetooth Smart* 4.1 functionalities.



The SaBLE-x module fully supports the single mode *Bluetooth* Low Energy operation, and the output power can support class 2. The module provides the ability to either put your entire application into the integrated ARM Cortex M3 microcontroller, or use the module in Network Processor mode in conjunction with the microcontroller of your choice. RF Core's dedicated ARM Cortex M0 improves system performance and frees up FLASH memory for custom applications.

Need to get to market quickly? Not an expert in *Bluetooth* Low Energy? Need a custom antenna? Do you need help with your host board? LSR Design Services will be happy to develop custom hardware or software, or help integrate the design. Contact us at sales@lsr.com or call us at 262-375-4400.

ORDERING INFORMATION

Order Number	Description
450-0119C	SaBLE-x Module, PCB Trace Antenna (Cut Tape)
450-0119R	SaBLE-x Module, PCB Trace Antenna (Tape & Reel)
450-0144C	SaBLE-x Module, External Antenna Port (Cut Tape)
450-0144R	SaBLE-x Module, External Antenna Port (Tape & Reel)
450-0150	SaBLE-x Development Board, PCB Trace Antenna

Table 1 Orderable Model Numbers

MODULE ACCESSORIES



	Order Number	Description
	001-0001	2.4 GHz Dipole Antenna with Reverse Polarity SMA Connector
	080-0001	U.FL to Reverse Polarity SMA Bulkhead Cable 105mm
	001-0014	2.4 GHz FlexPIFA Antenna

Table 2 Module Accessories

The information in this document is subject to change without notice.

BLOCK DIAGRAM

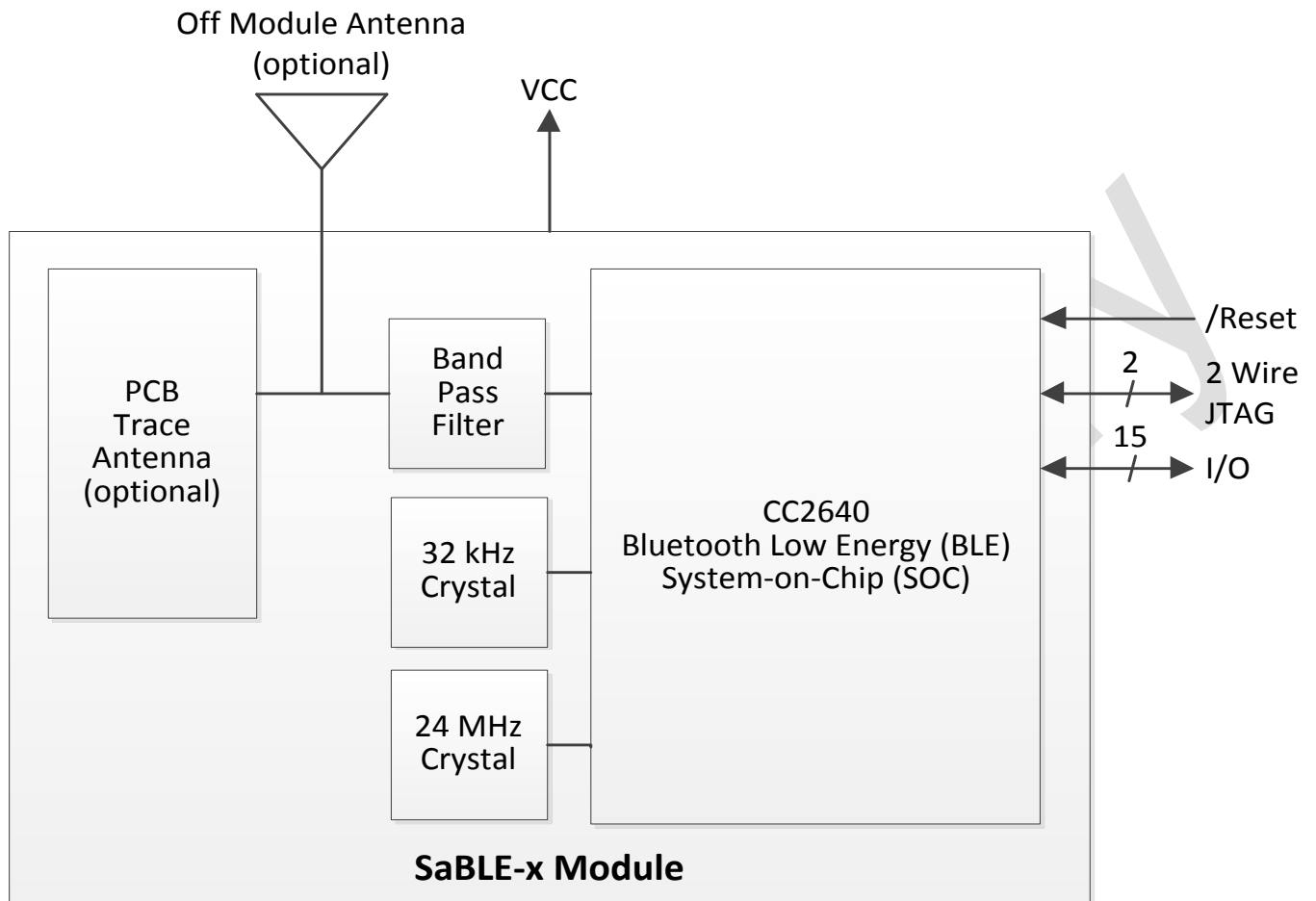

Figure 1 SaBLE-x Module Block Diagram

TABLE OF CONTENTS

FEATURES 1

APPLICATIONS..... 1

DESCRIPTION 1

ORDERING INFORMATION 2

MODULE ACCESSORIES 2

BLOCK DIAGRAM..... 3

FOOTPRINT AND PIN DEFINITIONS..... 6

PIN DESCRIPTIONS..... 7

ELECTRICAL SPECIFICATIONS 8

Absolute Maximum Ratings 8

Recommended Operating Conditions 8

General Characteristics 8

DC Characteristics 9

General Power Consumption 10

RF Characteristics 11

SOLDERING RECOMMENDATIONS 12

Recommended Reflow Profile for Lead Free Solder 12

CLEANING 13

OPTICAL INSPECTION 13

REWORK 13

SHIPPING, HANDLING, AND STORAGE 13

Shipping 13

Handling 13

Moisture Sensitivity Level (MSL) 13

Storage 13

Repeating Reflow Soldering 14

MECHANICAL DATA..... 15

PCB FOOTPRINT 16

The information in this document is subject to change without notice.

Tape & Reel Dimensions	17
DEVICE MARKINGS.....	18
CONTACTING LSR.....	19

Preliminary

FOOTPRINT AND PIN DEFINITIONS

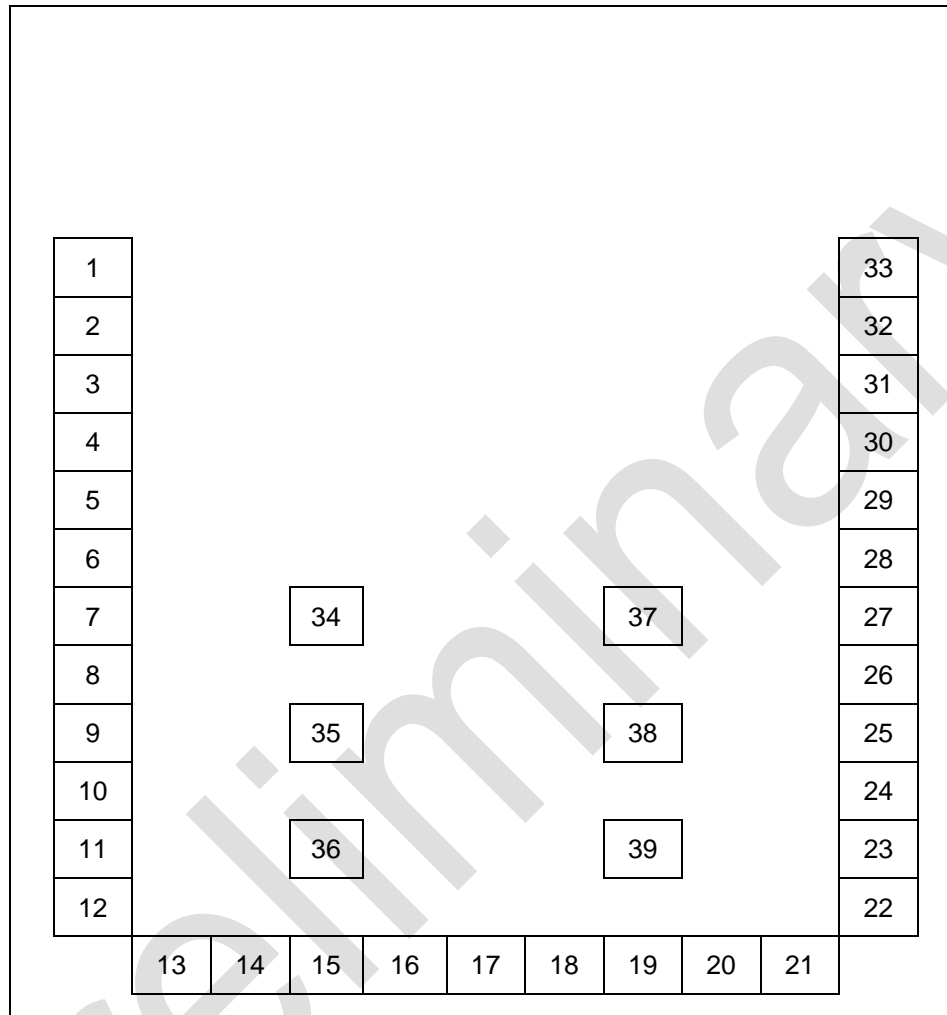

Figure 2 SaBLE-x Module Footprint (Viewed From Top)

PIN DESCRIPTIONS

Module Pin	Name	I/O Type	Description
1	RF OUT	RF	ANTENNA, 50 OHMS
2	GND	GND	GROUND
3	GND	GND	GROUND
4	NC	-	NO CONNECT (DO NOT CONNECT)
5	NC	-	NO CONNECT (DO NOT CONNECT)
6	/RESET	DI	ACTIVE LOW RESET
7	JTAG_TCKC	DI/DIO	JTAG TCKC
8	JTAG_TMSC	DIO	JTAG TMSC
9	NC	-	NO CONNECT (DO NOT CONNECT)
10	NC	-	NO CONNECT (DO NOT CONNECT)
11	VCC	PI	POWER SUPPLY TO MODULE
12	VCC	PI	POWER SUPPLY TO MODULE
13	DIO_5/JTAG_TDO	DIO	GPIO, JTAG_TDO, ULP SENSOR INTERFACE, LED DRIVING CAPABILITY
14	DIO_6/JTAG_TDI	DIO	GPIO, JTAG_TDI, ULP SENSOR INTERFACE, LED DRIVING CAPABILITY
15	DIO_4	DIO	GPIO, LED DRIVING CAPABILITY
16	DIO_3	DIO	GPIO, LED DRIVING CAPABILITY
17	DIO_2	DIO	GPIO, ULP SENSOR INTERFACE, LED DRIVING CAPABILITY
18	DIO_1/BOOT_RX	DIO	GPIO, ULP SENSOR INTERFACE, BOOTLOADER RX (UART0)
19	DIO_0/BOOT_TX	DIO	GPIO, ULP SENSOR INTERFACE, BOOTLOADER TX (UART0)
20	DIO_7	DIO	GPIO, ANALOG INPUT, ULP SENSOR INTERFACE
21	DIO_8	DIO	GPIO, ANALOG INPUT, ULP SENSOR INTERFACE
22	GND	GND	GROUND
23	DIO_10	DIO	GPIO, ANALOG INPUT, ULP SENSOR INTERFACE
24	DIO_9	DIO	GPIO, ANALOG INPUT, ULP SENSOR INTERFACE
25	NC	-	NO CONNECT (DO NOT CONNECT)
26	NC	-	NO CONNECT (DO NOT CONNECT)
27	NC	-	NO CONNECT (DO NOT CONNECT)
28	NC	-	NO CONNECT (DO NOT CONNECT)
29	DIO_11	DIO	GPIO, ANALOG INPUT, ULP SENSOR INTERFACE
30	DIO_12	DIO	GPIO, ANALOG INPUT, ULP SENSOR INTERFACE
31	DIO_13	DIO	GPIO, ANALOG INPUT, ULP SENSOR INTERFACE
32	DIO_14	DIO	GPIO, ANALOG INPUT, ULP SENSOR INTERFACE
33	GND	GND	GROUND
34-39	GND	GND	GROUND AND THERMAL RELIEF PADS

PI = Power Input GND = Ground DI = Digital Input DO = Digital Output DIO = Digital Input/Output AI = Analog Input
RF = Bi-directional RF Port Note: See the Texas Instruments CC2640 datasheet and user guide for further details on the I/O.

Table 3 SaBLE-x Pin Descriptions

The information in this document is subject to change without notice.

ELECTRICAL SPECIFICATIONS

Absolute Maximum Ratings

Symbol	Description	Min	Max	Unit
VCC	Digital Input Supply Voltage	-0.3	4.1	V
Voltage on any digital pin		-0.3	VCC+0.3, max 4.1	V
Input RF level			+5	dBm

Table 4 Absolute Maximum Ratings¹

Recommended Operating Conditions

Test conditions: Ambient Temp = 25°C

Symbol	Min	Typ	Max	Unit
VCC	1.8	3.3	3.8	V

Table 5 Recommended Operating Conditions

General Characteristics

Characteristic	Description
Model Name	SaBLE-x
Product Description	Bluetooth Low Energy Wireless Module
Dimension	11.6 mm x 17.9 mm x 2.4 mm (W*L*T)
Operating temperature	-40°C to 85°C
Storage temperature	-40°C to 85°C
Humidity	Operating Humidity 10% to 95% Non-Condensing Storage Humidity 5% to 95% Non-Condensing
Weight	0.75g +/- 0.05g

Table 6 General Characteristics

¹ Under no circumstances should exceeding the ratings specified in the Absolute Maximum Ratings section be allowed. Stressing the module beyond these limits may result permanent damage to the module that is not covered by the warranty.

DC Characteristics

Parameter	Test Conditions	Min	Typ	Max	Unit
Input low-to-high transition with hysteresis	Transition from 0→1, T _A = 25C, VCC=1.8V		1.07		V
Input high-to-low transition with hysteresis	Transition from 1→0, T _A = 25C, VCC=1.8V		.74		V
Input hysteresis	Difference between 0→1 and 1→0.		.33		V
Input low-to-high transition with hysteresis	Transition from 0→1, T _A = 25C, VCC=3.8V		1.94		V
Input high-to-low transition with hysteresis	Transition from 1→0, T _A = 25C, VCC=3.8V		1.54		V
Input hysteresis	Difference between 0→1 and 1→0.		.4		V
Logic-0 output voltage, 4 mA pins	Output load 4 mA, T _A = 25C, VCC=1.8V		.26		V
Logic-1 output voltage, 4 mA pins	Output load 4 mA, T _A = 25C, VCC=1.8V		1.54		V
Logic-0 output voltage, 8 mA pins	Output load 8 mA, T _A = 25C, VCC=1.8V		.21		V
Logic-1 output voltage, 8 mA pins	Output load 8 mA, T _A = 25C, VCC=1.8V		1.58		V
Logic-0 output voltage, 4 mA pins	Output load 4 mA, T _A = 25C, VCC=3.0V		.33		V
Logic-1 output voltage, 4 mA pins	Output load 4 mA, T _A = 25C, VCC=3.0V		2.72		V
Logic-0 output voltage, 8 mA pins	Output load 8 mA, T _A = 25C, VCC=3.0V		.28		V
Logic-1 output voltage, 8 mA pins	Output load 8 mA, T _A = 25C, VCC=3.0V		2.68		V
Input pullup current	Vpad=0V, T _A = 25C, VCC=1.8V		72		uA
Input pulldown current	Vpad=1.8V, T _A = 25C, VCC=1.8V		22		uA
Input pullup current	Vpad=0V, T _A = 25C, VCC=3.8V		277		uA
Input pulldown current	Vpad=3.8V, T _A = 25C, VCC=3.8V		113		uA

Table 7 SaBLE-x Module Bluetooth General DC Characteristics

General Power Consumption

$T_A = 25^\circ\text{C}$ and $V_{CC} = 3\text{ V}$

Parameter	Test Conditions	Min	Typ	Max	Unit
Shutdown	No clocks running, no data retention		200		nA
Standby 1	With RTC, CPU, RAM and partial register retention. XOSC_LF		1.2		uA
Standby 2	With Cache, RTC, CPU, RAM and partial register retention. XOSC_LF		2.7		uA
Idle	Supply Systems and RAM powered.		550		uA
Active	Core running CoreMark		1.45mA + 31uA/MHz		
Radio Receive			6.1		mA
Radio Transmit	+5 dBm output power		9.1		mA

Table 8 SaBLE-x Module Bluetooth Power Consumption Specifications

RF Characteristics

Pending – Reference TI CC2640 Datasheet for preliminary values.

Preliminary

SOLDERING RECOMMENDATIONS

Recommended Reflow Profile for Lead Free Solder

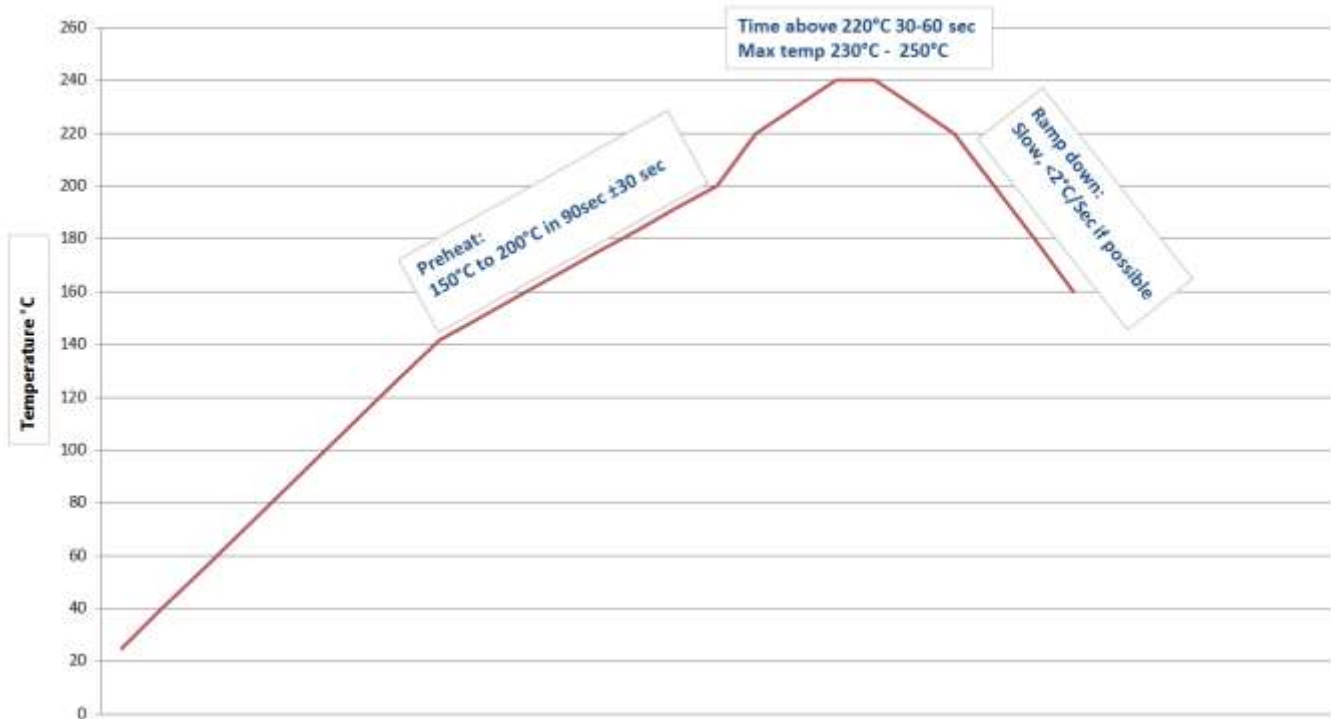

Figure 3 Recommended Soldering Profile

Note: The quality of solder joints on the surface mount pads where they contact the host board should meet the appropriate IPC Specification. See IPC-A-610-D Acceptability of Electronic Assemblies, section 8.2.1 “Bottom Only Terminations.”

CLEANING

In general, cleaning the populated modules is strongly discouraged. Residuals under the module cannot be easily removed with any cleaning process.

- Cleaning with water can lead to capillary effects where water is absorbed into the gap between the host board and the module. The combination of soldering flux residuals and encapsulated water could lead to short circuits between neighboring pads. Water could also damage any stickers or labels.
- Cleaning with alcohol or a similar organic solvent will likely flood soldering flux residuals into the RF shield, which is not accessible for post-washing inspection. The solvent could also damage any stickers or labels.
- Ultrasonic cleaning could damage the module permanently.

OPTICAL INSPECTION

After soldering the Module to the host board, consider optical inspection to check the following:

- Proper alignment and centering of the module over the pads.
- Proper solder joints on all pads.
- Excessive solder or contacts to neighboring pads, or vias.

REWORK

The module can be unsoldered from the host board if the Moisture Sensitivity Level (MSL) requirements are met as described in this datasheet.

Never attempt a rework on the module itself, e.g. replacing individual components. Such actions will terminate warranty coverage.

SHIPPING, HANDLING, AND STORAGE

Shipping

Bulk orders of the SaBLE-x modules are delivered in reels of 1,000.

Handling

The SaBLE-x modules contain a highly sensitive electronic circuitry. Handling without proper ESD protection may damage the module permanently.

Moisture Sensitivity Level (MSL)

Per J-STD-020, devices rated as MSL 4 and not stored in a sealed bag with desiccant pack should be baked prior to use.

Devices are packaged in a Moisture Barrier Bag with a desiccant pack and Humidity Indicator Card (HIC). Devices that will be subjected to reflow should reference the HIC and J-STD-033 to determine if baking is required.

If baking is required, refer to J-STD-033 for bake procedure.

Storage

Per J-STD-033, the shelf life of devices in a Moisture Barrier Bag is 12 months at <40°C and <90% room humidity (RH).

Do not store in salty air or in an environment with a high concentration of corrosive gas, such as Cl₂, H₂S, NH₃, SO₂, or NO_x.

Do not store in direct sunlight.

The product should not be subject to excessive mechanical shock.

Repeating Reflow Soldering

Only a single reflow soldering process is encouraged for host boards.

Preliminary

MECHANICAL DATA

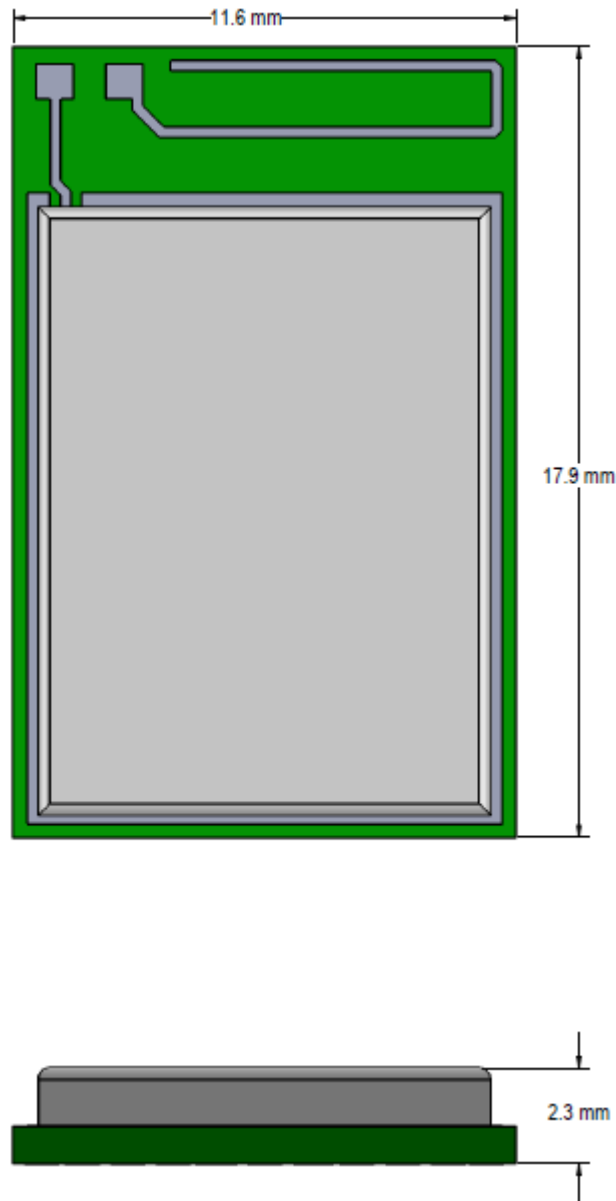

Figure 4 Module Mechanical Dimensions (Maximum Module Height = 2.4mm)

PCB FOOTPRINT

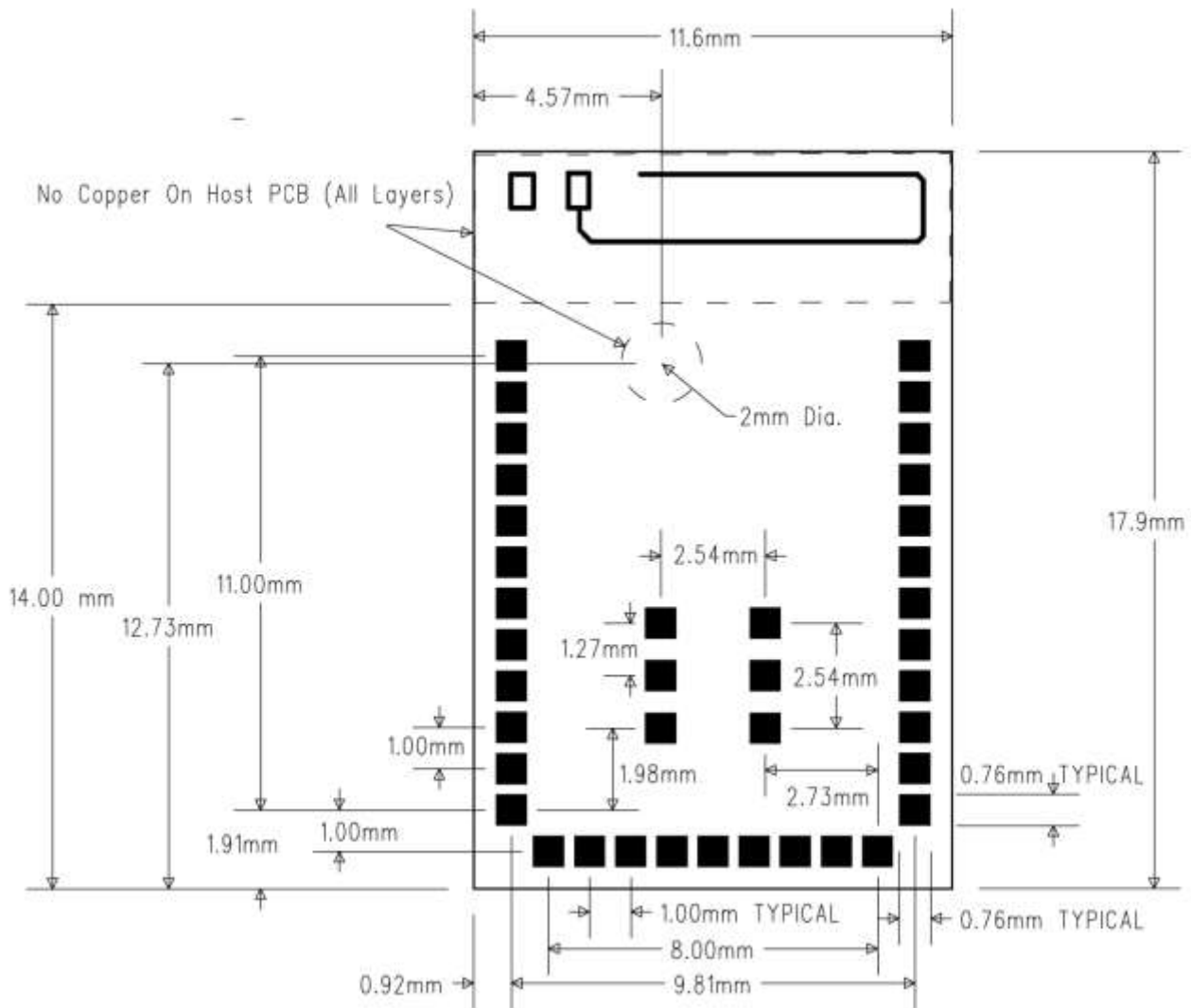

Figure 5 SaBLE-x Recommended PCB Footprint (Viewed from Top)

Tape & Reel Dimensions

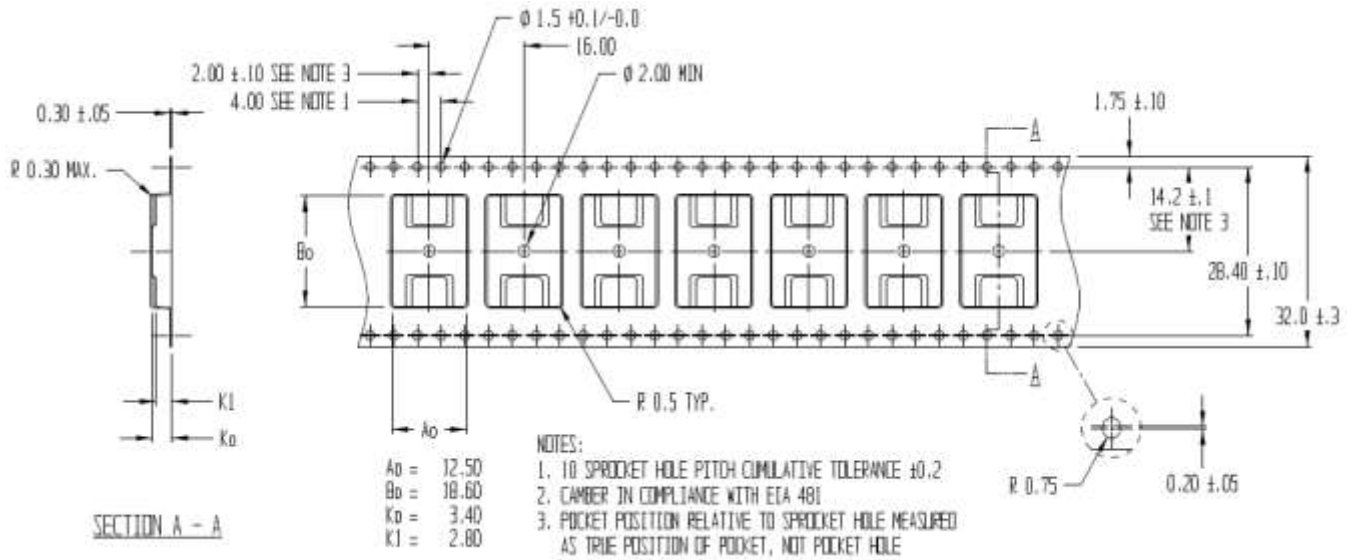

Figure 6 Tape and Reel Specification

DEVICE MARKINGS

Pending

Preliminary

CONTACTING LSR

Headquarters

LSR
W66 N220 Commerce Court
Cedarburg, WI 53012-2636
USA
Tel: 1(262) 375-4400
Fax: 1(262) 375-4248

Website

www.lsr.com

Technical Support

forum.lsr.com

Sales Contact

sales@lsr.com

The information in this document is provided in connection with LS Research (hereafter referred to as “LSR”) products. No license, express or implied, by estoppel or otherwise, to any intellectual property right is granted by this document or in connection with the sale of LSR products. EXCEPT AS SET FORTH IN LSR’S TERMS AND CONDITIONS OF SALE LOCATED ON LSR’S WEB SITE, LSR ASSUMES NO LIABILITY WHATSOEVER AND DISCLAIMS ANY EXPRESS, IMPLIED OR STATUTORY WARRANTY RELATING TO ITS PRODUCTS INCLUDING, BUT NOT LIMITED TO, THE IMPLIED WARRANTY OF MERCHANTABILITY, FITNESS FOR A PARTICULAR PURPOSE, OR NON-INFRINGEMENT. IN NO EVENT SHALL LSR BE LIABLE FOR ANY DIRECT, INDIRECT, CONSEQUENTIAL, PUNITIVE, SPECIAL OR INCIDENTAL DAMAGES (INCLUDING, WITHOUT LIMITATION, DAMAGES FOR LOSS OF PROFITS, BUSINESS INTERRUPTION, OR LOSS OF INFORMATION) ARISING OUT OF THE USE OR INABILITY TO USE THIS DOCUMENT, EVEN IF LSR HAS BEEN ADVISED OF THE POSSIBILITY OF SUCH DAMAGES. LSR makes no representations or warranties with respect to the accuracy or completeness of the contents of this document and reserves the right to make changes to specifications and product descriptions at any time without notice. LSR does not make any commitment to update the information contained herein. Unless specifically provided otherwise, LSR products are not suitable for, and shall not be used in, automotive applications. LSR’s products are not intended, authorized, or warranted for use as components in applications intended to support or sustain life.