

Data Sheet

Description

The MSA-1110 is a high performance silicon bipolar Monolithic Microwave Integrated Circuit (MMIC) housed in a hermetic high reliability package. This MMIC is designed for high dynamic range in either 50 or 75Ω systems by combining low noise figure with high IP_3 . Typical applications include narrow and broadband linear amplifiers in industrial and military systems.

The MSA-series is fabricated using Avago's 10 GHz f_T , 25 GHz f_{MAX} silicon bipolar MMIC process which uses nitride self-alignment, ion implantation, and gold metallization to achieve excellent performance, uniformity and reliability. The use of an external bias resistor for temperature and current stability also allows bias flexibility.

Features

- High Dynamic Range Cascadable 50Ω or 75Ω Gain Block
- 3 dB Bandwidth: 50 MHz to 1.6 GHz
- 17.5 dBm Typical $P_{1\text{ dB}}$ at 0.5 GHz
- 12 dB Typical 50 Ω Gain at 0.5 GHz
- 3.5 dB Typical Noise Figure at 0.5 GHz
- Hermetic Gold-ceramic Microstrip Package

100 mil Package

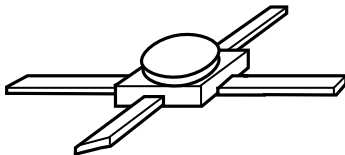

Typical Biasing Configuration

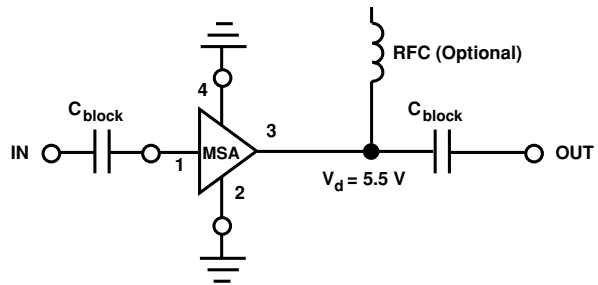

MSA-1110 Absolute Maximum Ratings

Parameter	Absolute Maximum ^[1]
Device Current	90 mA
Power Dissipation ^[2,3]	560 mW
RF Input Power	+13 dBm
Junction Temperature	200°C
Storage Temperature	-65 to 200°C

Thermal Resistance^[2, 4]:

$$\theta_{jc} = 135^{\circ}\text{C/W}$$

Notes:

1. Permanent damage may occur if any of these limits are exceeded.
2. $T_{\text{CASE}} = 25^{\circ}\text{C}$.
3. Derate at $7.4 \text{ mW}/^{\circ}\text{C}$ for $T_{\text{C}} > 124^{\circ}\text{C}$.
4. The small spot size of this technique results in a higher, though more accurate determination of θ_{jc} than do alternate methods.

Electrical Specifications^[1], $T_{\text{A}} = 25^{\circ}\text{C}$

Symbol	Parameters and Test Conditions: $I_{\text{d}} = 60 \text{ mA}$, $Z_0 = 50 \Omega$	Units	Min.	Typ.	Max.
G_{p}	Power Gain ($ S_{21} ^2$) $f = 0.1 \text{ GHz}$	dB	11.5	12.5	13.5
ΔG_{p}	Gain Flatness $f = 0.1 \text{ to } 1.0 \text{ GHz}$	dB		± 0.7	± 1.0
$f_{3 \text{ dB}}$	3 dB Bandwidth ^[2]	GHz		1.6	
VSWR	Input VSWR $f = 0.1 \text{ to } 1.0 \text{ GHz}$			1.7:1	
	Output VSWR $f = 0.1 \text{ to } 1.0 \text{ GHz}$			1.9:1	
NF	50 Ω Noise Figure $f = 0.5 \text{ GHz}$	dB		3.5	4.5
$P_{1 \text{ dB}}$	Output Power at 1 dB Gain Compression $f = 0.5 \text{ GHz}$	dBm	16.0	17.5	
IP_3	Third Order Intercept Point $f = 0.5 \text{ GHz}$	dBm		30.0	
t_{D}	Group Delay $f = 0.5 \text{ GHz}$	psec		160	
V_{d}	Device Voltage	V	4.5	5.5	6.5
dV/dT	Device Voltage Temperature Coefficient	mV/ $^{\circ}\text{C}$		-8.0	

Notes:

1. The recommended operating current range for this device is 40 to 75 mA. Typical performance as a function of current is on the following page.
2. Referenced from 50 MHz gain (GP).

MSA-1110 Typical Scattering Parameters ($Z_0 = 50 \Omega$, $T_A = 25^\circ\text{C}$, $I_d = 60 \text{ mA}$)

Freq. GHz	S_{11}			S_{21}			S_{12}		S_{22}		k
	Mag	Ang	dB	Mag	Ang	dB	Mag	Ang	Mag	Ang	
.0005	.83	-7	19.5	9.44	176	-31.9	.025	39	.84	-7	0.77
.005	.54	-50	16.8	6.92	158	-18.7	.116	34	.55	-50	0.60
.025	.15	-78	13.0	4.47	167	-16.6	.148	9	.15	-79	1.03
.050	.10	-64	12.6	4.26	171	-16.5	.149	5	.10	-67	1.08
.100	.08	-63	12.5	4.23	171	-16.5	.150	4	.08	-66	1.09
.200	.09	-74	12.4	4.17	166	-16.4	.152	4	.09	-78	1.09
.300	.11	-85	12.3	4.10	160	-16.2	.154	5	.12	-89	1.07
.400	.13	-94	12.3	4.10	154	-16.1	.157	6	.15	-98	1.05
.500	.16	-102	12.1	4.04	148	-15.9	.161	7	.18	-106	1.02
.600	.18	-108	12.0	3.98	143	-15.6	.165	8	.20	-113	1.00
.700	.21	-114	11.8	3.89	137	-15.4	.169	8	.23	-120	0.97
.800	.23	-120	11.6	3.80	131	-15.2	.173	8	.25	-126	0.95
.900	.25	-126	11.4	3.71	126	-15.0	.178	8	.28	-132	0.92
1.000	.27	-131	11.1	3.60	120	-14.8	.182	8	.30	-137	0.91
1.500	.36	-153	9.8	3.10	96	-13.8	.203	4	.37	-160	0.83
2.000	.42	-171	8.4	2.64	74	-13.3	.217	1	.40	-178	0.82
2.500	.47	177	7.2	2.29	59	-12.5	.236	-2	.41	172	0.80
3.000	.47	159	5.9	1.97	43	-13.2	.220	-10	.38	157	0.95

Typical Performance, $T_A = 25^\circ\text{C}$, $Z_0 = 50 \Omega$

(unless otherwise noted)

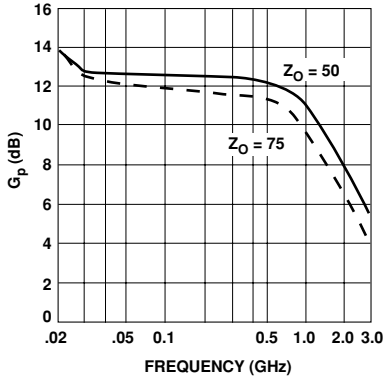

Figure 1. Typical Power Gain vs. Frequency, $I_d = 60 \text{ mA}$.

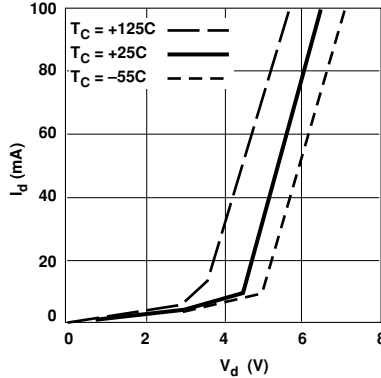

Figure 2. Device Current vs. Voltage.

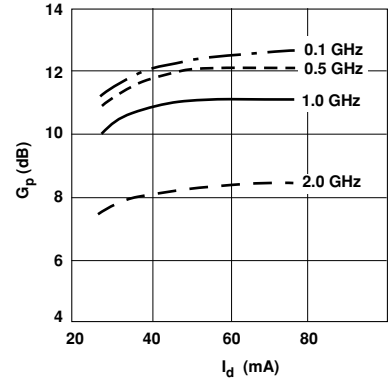

Figure 3. Power Gain vs. Current.

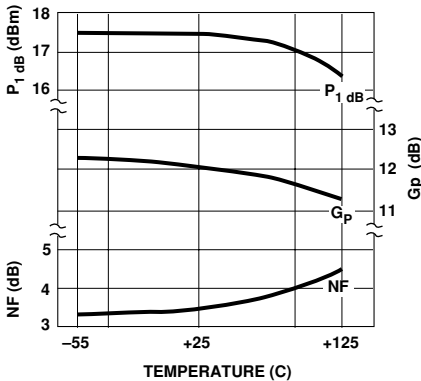

Figure 4. Output Power at 1 dB Gain Compression, Noise Figure and Power Gain vs. Case Temperature, $f = 0.5 \text{ GHz}$, $I_d = 60 \text{ mA}$.

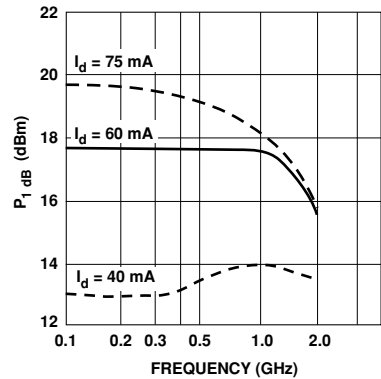

Figure 5. Output Power at 1 dB Gain Compression vs. Frequency.

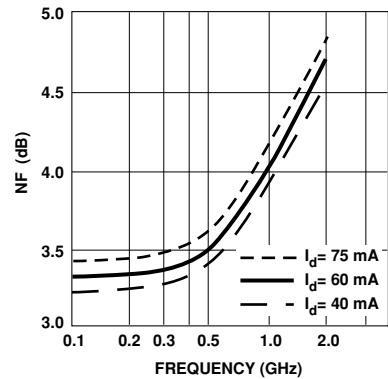
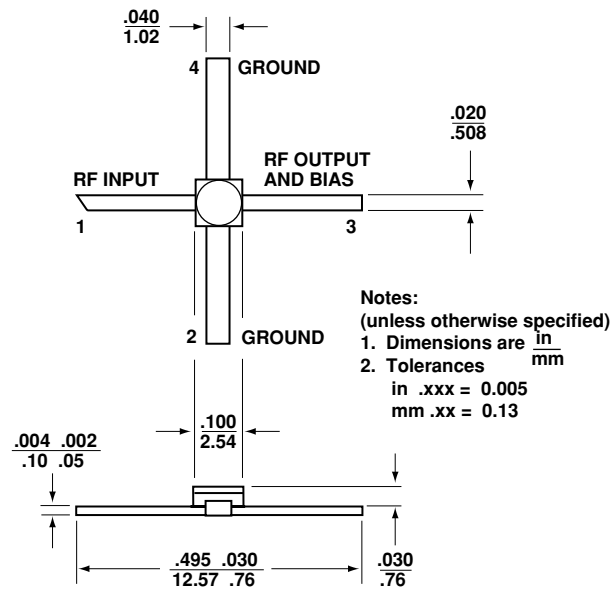

Figure 6. Noise Figure vs. Frequency.

Ordering Information

Part Numbers	No. of Devices	Comments
MSA-1110	100	Bulk

100 mil Package Dimensions



For product information and a complete list of distributors, please go to our web site: www.avagotech.com

Avago, Avago Technologies, and the A logo are trademarks of Avago Technologies, Limited in the United States and other countries. Data subject to change. Copyright © 2008 Avago Technologies, Limited. All rights reserved. Obsoletes 5989-2747EN AV02-1233EN - May 29, 2008

AVAGO
TECHNOLOGIES