

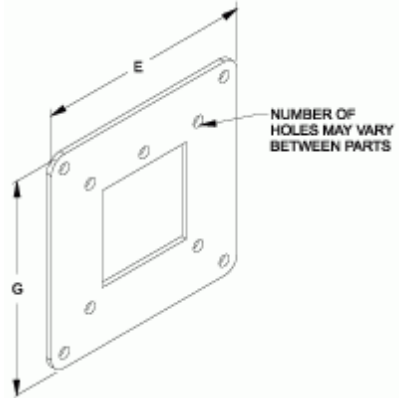

Quality Products. Service Excellence.

Reducers (Center Hole) 1487RC Series



Part No.	Reduces from	to	H	W
1487CRC	4 x 4	2.5 x 2.5	5.37	5.37
1487DRC	6 x 6	4 x 4	7.62	7.62
1487ERCC	8 x 8	4 x 4	9.62	9.62
1487ERCD	8 x 8	6 x 6	9.62	9.62

Data subject to change without notice



© 2023. Hammond Manufacturing Ltd. All rights reserved.