

Order No.: 1061730

Type: FP 0,8/ 80-MV 1,15

SMD male connector, Reflow soldering

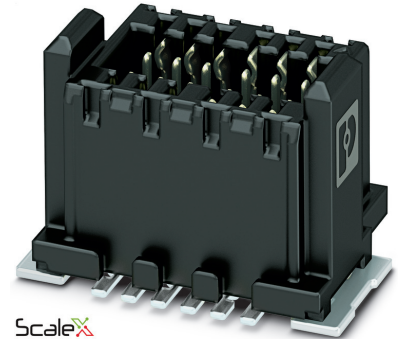

ScaleX

The figure shows a 12-pos. version with 12 contacts

1 Main features

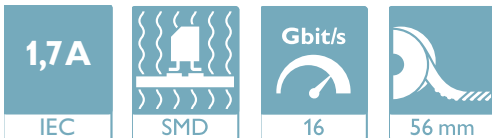

- | | | | |
|----------------|--------------|------------------------|-----------------|
| • No. of pos. | 80 | • Nominal current | 1.7 A |
| • Test voltage | 500 V AC | • Mounting type | SMD soldering |
| • Color | black (9005) | • Connection direction | 90 ° |
| • Pitch | 0.8 mm | • Type of packaging | 56 mm wide tape |

2 Your advantages

- ✓ Gold-plated contacts ensure transfer quality remains stable over the long term
- ✓ Reliable mechanical and electrical connections, thanks to the double-sided ScaleX contact system
- ✓ Robustness: ScaleX technology for high tolerance compensation and protection of contacts
- ✓ Flexible device design: various numbers of positions, designs, and stack heights with high wipe lengths



Make sure you always use the latest documentation.
It can be downloaded at: phoenixcontact.net/product/1061730

3 Table of contents

1	Main features.....	1
2	Your advantages	1
3	Table of contents	2
4	3D model in PDF can be activated (Acrobat Reader only).....	3
5	General Technical Data	4
	5.1 item properties	4
	5.2 Material data	4
6	Dimensions.....	5
	6.1 Dimensions for the product	5
	6.2 Dimensions for the application	5
7	Series drawing.....	6
8	Packaging information	7
9	Blister drawing.....	8
10	Application.....	9
	10.1 Temperature limit values	9
11	General tests	10
	11.1 Specification.....	10
12	Mechanical tests.....	11
	12.1 Insertion and withdrawal force per contact	11
	12.2 Service life	11
13	Electrical tests	12
	13.1 Electrical data	12
	13.2 Air and creepage distances	12
14	Current carrying capacity/derating curves	13
	14.1 Insulation resistance.....	13
	14.2 forward resistance	13
	14.3 Vibration test	13
	14.4 Shock test.....	13
15	Approvals / Certificates.....	14
16	Commercial Data.....	15
17	Combination tests.....	16

1061730 FP 0,8/ 80-MV 1,15

4 3D model in PDF can be activated (Acrobat Reader only)

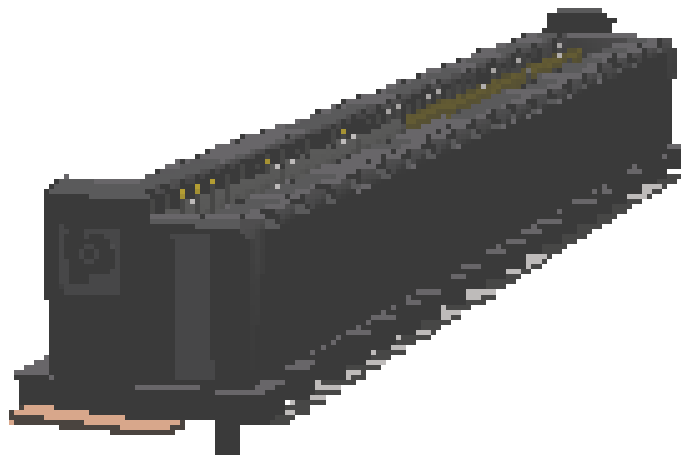

1061730 FP 0,8/ 80-MV 1,15**5 General Technical Data****5.1 item properties**

Order No.	1061730
Type	FP 0,8/ 80-MV 1,15
Plug-in system	FINEPITCH 0,8 mm
Product type	SMD male connector
Type of contact	Male connector
Range of articles	FP 0,8/...-MV 1,15
Pitch	0.8 mm
Range of positions	12...80
Number of positions	80
Number of levels	2
Number of potentials	80
Mounting type	SMD soldering
Connection direction of the connector to the PCB	90 °
Pin layout	Linear pad geometry

5.2 Material data

Material of metal parts	
Note	WEEE/RoHS-compliant, whisker-free acc. to IEC 60068-2-82/JEDEC JESD 201
Contact material	Cu alloy
Surface contact area	Nickel (Ni), , Gold (Au)
Soldering area surface	Nickel (Ni) , Tin (Sn)
Surface characteristics	Selective coating
Insulating material data	
Insulating material	LCP
Insulating material group	IIIa
CTI according to IEC 60112	150
Flammability rating according to UL 94	V0
Color	black (9005)

1061730 FP 0,8/ 80-MV 1,15**6 Dimensions****6.1 Dimensions for the product**

Length	6.1 mm
Width	35.09 mm
Total height	6.25 mm
Height	5.65 mm
Positioning pin geometry	, Length of positioning pin: 0.6 mm
Coplanarity	≤ 0.1 mm

6.2 Dimensions for the application

Contact cover	0.8 mm
Overlap length	1.5 mm
Medium offset	± 0.7 mm in longitudinal and transverse direction
Angular tolerance	± 2 ° in longitudinal direction
Angular tolerance	± 4 ° in transverse direction
Stacking height	6 mm Tolerance: +1,5 mm (in combination with Range of articles:FP 0,8/...-FV 4,85)
Stacking height	9 mm Tolerance: +1,5 mm (in combination with Range of articles:FP 0,8/...-FV 7,85)

1061730 FP 0,8/ 80-MV 1,15

7 Series drawing

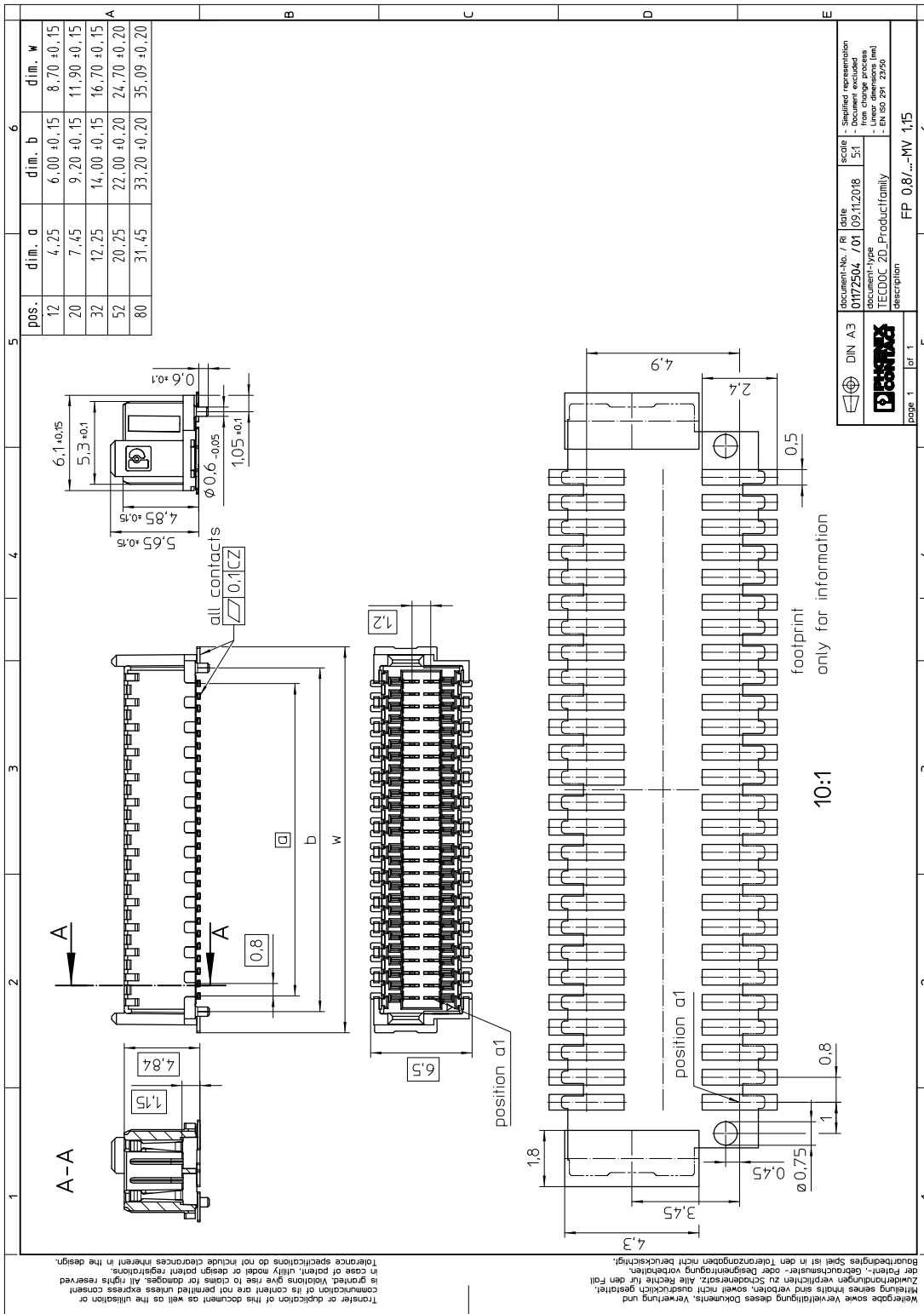

1061730 FP 0,8/ 80-MV 1,15**8 Packaging information**

Type of packaging	56 mm wide tape
Note on packaging	Tape-on-reel packaging in accordance with standard DIN EN 60286-3 and EIA-481
Pieces per package	500
Outer packaging type	Transparent-Bag
ESD level	(D) electrostatically conductive
Specification	DIN EN 61340-5-1 (VDE 0300-5-1): 2008-07
[W] tape width	56.4 mm
[A] coil diameter	330 mm
[W2] coil overall dimension	60.4 mm
Number of products per coil	500

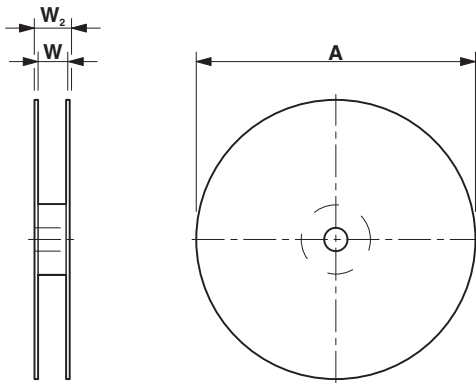

1061730 FP 0,8/ 80-MV 1,15

9 Blister drawing

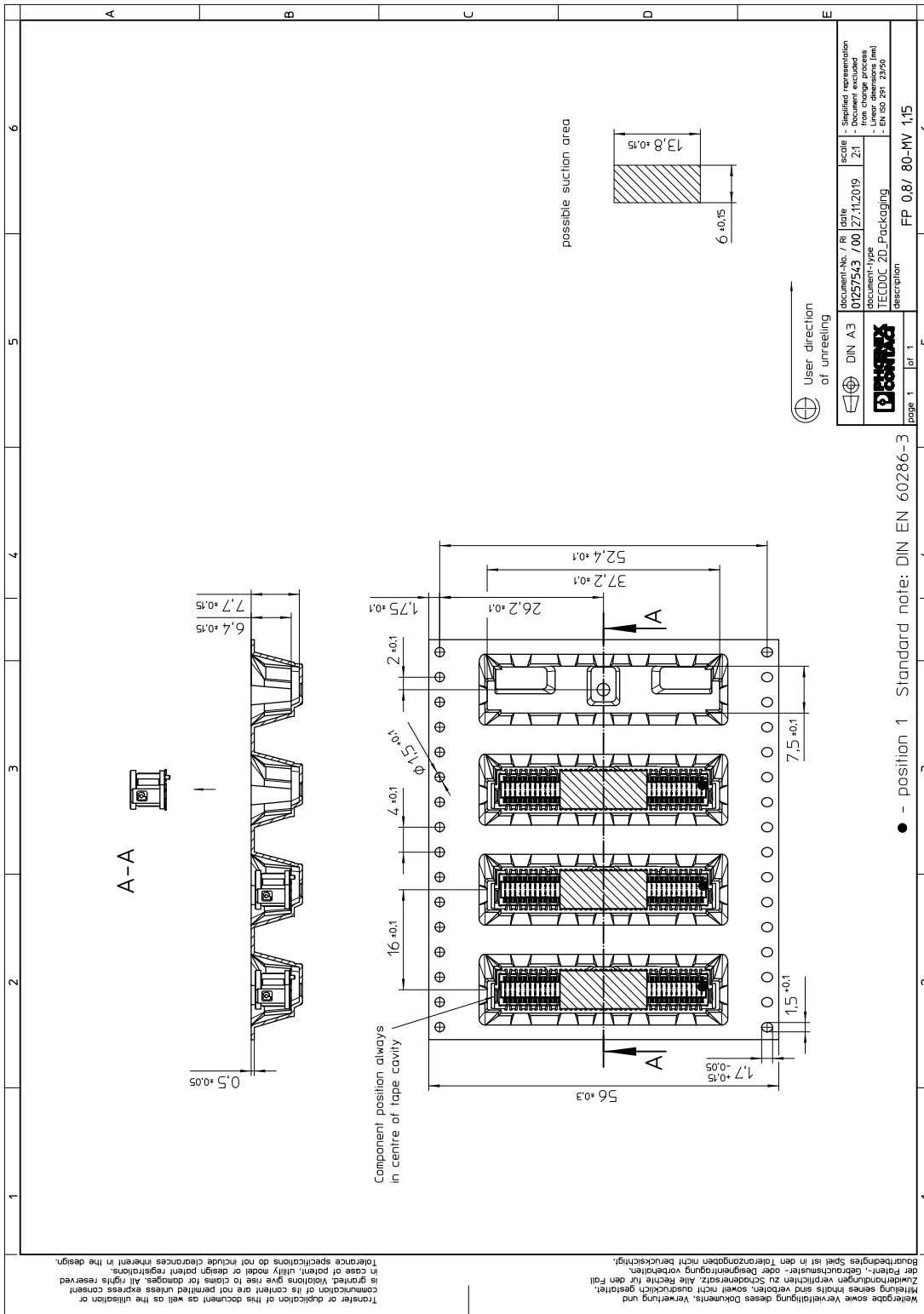

10 Application

10.1 Temperature limit values

Ambient temperature (storage/transport)	-40 °C ... 70 °C
Ambient temperature (assembly)	-5 °C ... 100 °C
Ambient temperature (operation)	-55 °C ... 125 °C

1061730 FP 0,8/ 80-MV 1,15

11 General tests

11.1 Specification



Brief description

Board-to-board connectors

1061730 FP 0,8/ 80-MV 1,15**12 Mechanical tests****12.1 Insertion and withdrawal force per contact**

Insertion and withdrawal force per contact	≤ 0.6 N
--	---------

12.2 Service life

Specification	IEC 60512-9-1:2010-03 (following)
Service life	500 Insertion/withdrawal cycles, Performance level 1

1061730 FP 0,8/ 80-MV 1,15**13 Electrical tests****13.1 Electrical data**

Nominal current at 20 °C	1.7 A (52-pos.)
Test voltage	500 V AC IEC 60512-4-1:2003

13.2 Air and creepage distances

Minimum value for clearance and creepage distance	0.25 mm
---	---------

1061730 FP 0,8/ 80-MV 1,15**14 Current carrying capacity/derating curves****14.1 Insulation resistance**

Insulation resistance	≥ 5 GΩ, (IEC 60512-3-1:2002-02)
-----------------------	---------------------------------

14.2 forward resistance

Contact resistance	≤20 mΩ, (IEC 60512-2-1:2002-02)
--------------------	---------------------------------

14.3 Vibration test

Specification	IEC 60068-2-6:2007-12
Result	Test passed
Frequency	10 - 2000 - 10 Hz
Sweep speed	1 octave/min
Amplitude	1.5 mm (10 - 60.1 Hz)
Acceleration	200 m/s ² (58 - 2000 Hz)
Test duration per axis	2.5 h
Test directions	X-, Y- and Z-axis

Note

14.4 Shock test

Specification	IEC 60068-2-27:2008-02
Result	Test passed
Pulse shape	Semi-sinusoidal
Peak acceleration	490 m/s ²
Shock duration	11 ms
Number of shocks per direction	3
Test directions	X-, Y- and Z-axis (pos. and neg.)

1061730 FP 0,8/ 80-MV 1,15

15 Approvals / Certificates

1061730 FP 0,8/ 80-MV 1,15**16 Commercial Data**

Order No.	1061730
Type	FP 0,8/ 80-MV 1,15
Pieces per package	500
Net weight	3.274 g
GTIN	4055626715285
	Information that applies locally, see link on page 1
Country of origin	Information that applies locally, see link on page 1

1061730 FP 0,8/ 80-MV 1,15

17 Combination tests

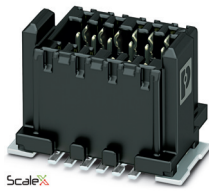

FP 0,8/...-MV 1,15

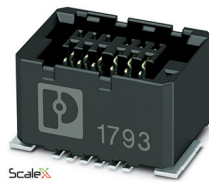

FP 0,8/...-FV 4,85



FP 0,8/...-FV 7,85

Mechanical tests				
Durability tests				
Contact resistance R ₁	20 mΩ	20 mΩ		
Insertion/withdrawal cycles	500	500		
Contact resistance R ₂	20 mΩ	20 mΩ		
Thermal tests				