



A Product Line of  
Diodes Incorporated



## SPECIFICATION FOR APPROVAL

|                   |  |
|-------------------|--|
| CUSTOMER          | _____  |
| NOMINAL FREQUENCY | 37.125000 MHz  |
| HOLDER TYPE       | TYPE FK 3.2x2.5 SEAM SEALED CRYSTAL CLOCK OSCILLATOR |
| SPEC. NO. ( P/N ) | FK3710003  |
| CUSTOMER P/N      | _____  |
| ISSUE DATE        | May 18, 2018   |
| VERSION           | B  |

| APPROVED          | PREPARED            | QA               |
|-------------------|---------------------|------------------|
| <i>Brenda Kuo</i> | <i>Winnie Chang</i> | <i>Dony Yang</i> |

### Diodes Incorporated

No.2, Ziqiang 5th Rd., Zhongli Industrial Park,  
 Zhongli Dist., Taoyuan City 32063, Taiwan (R.O.C.)  
 TEL: 886-3-451-8888  
 FAX: 886-3-461-3865  
<https://www.diodes.com>

- \*Pb-free
- \*RoHS Compliant
- \*HF-Halogen Free
- \*REACH Compliant

# TYPE FK 3.2x2.5 SEAM SEALED CRYSTAL CLOCK OSCILLATOR

## **FK3710003**

VER. B 18-May-18

### VERSION HISTORY

| Version No. | Version Date | Description     | Notes |
|-------------|--------------|-----------------|-------|
| A           | Jul.6,2012   | Initial Release |       |
| B           | May.18,2018  | Updated Logo    |       |
|             |              |                 |       |
|             |              |                 |       |
|             |              |                 |       |
|             |              |                 |       |
|             |              |                 |       |
|             |              |                 |       |
|             |              |                 |       |
|             |              |                 |       |
|             |              |                 |       |
|             |              |                 |       |
|             |              |                 |       |
|             |              |                 |       |
|             |              |                 |       |
|             |              |                 |       |
|             |              |                 |       |
|             |              |                 |       |
|             |              |                 |       |
|             |              |                 |       |
|             |              |                 |       |
|             |              |                 |       |
|             |              |                 |       |

# TYPE FK 3.2x2.5 SEAM SEALED CRYSTAL CLOCK OSCILLATOR

**FK3710003**

VER. B 18-May-18

## ELECTRICAL SPECIFICATIONS

**SRe Part Number : FK3710003**

| Item                            | Symbol                         | Specifications      | Units | Notes                                |
|---------------------------------|--------------------------------|---------------------|-------|--------------------------------------|
| Nominal Frequency               | F <sub>o</sub>                 | 37.125000           | MHz   |                                      |
| Frequency Stability             | FT                             | ± 25                | ppm   | **See note                           |
| Operating Temperature Range     | TR                             | -20 to +70          | °C    |                                      |
| Supply Voltage                  | V <sub>DD</sub>                | +1.8 ± 5.0%         | V     |                                      |
| Logic Type                      | LT                             | LVC MOS             |       |                                      |
| Supply Current, Output Enabled  | I <sub>DD</sub> /OE            | 7                   | mA    | Max.                                 |
| Supply Current, Output Disabled | I <sub>DD</sub> /OD            | 10                  | µA    | Max.                                 |
| Duty Cycle (Symmetry)           | DC/SY                          | 45 / 55             | %     | Measured 50% of Waveform             |
| Rise / Fall Time                | T <sub>R</sub> /T <sub>F</sub> | 2.5                 | ns    | Max. measured 20/80% of Waveform     |
| Output Voltage "0" Level        | V <sub>OL</sub>                | 10% V <sub>DD</sub> | V     | Max at I <sub>OL</sub> = 4.0mA Min.  |
| Output Voltage "1" Level        | V <sub>OH</sub>                | 90% V <sub>DD</sub> | V     | Min at I <sub>OH</sub> = -4.0mA Max. |
| Output Load                     | CL                             | 15                  | pF    | Max.                                 |
| Jitter, Phase                   | RMS                            | 1                   | ps    | Max. 12KHz ~ 5MHz Frequency Band     |
| Jitter, Accumulated             | RMS(1-σ)                       | 5                   | ps    | Max. 20,000 Consecutive Periods      |
| Jitter, Peak to Peak            | Pk-Pk                          | 30                  | ps    | Max. 100,000 Random Periods          |
| Start Up Time                   |                                | 10                  | ms    | Max.                                 |
| Storage Temperature Range       |                                | -55 to +125         | °C    |                                      |

※ This product doesn't include harmful substance that stipulated by SONY SS-00259 Level 1 and S-AT2-001 Level 1 standard. RoHS Compliant (Pb - Free).

**\*\*Stability includes all combinations of Operating Temperature, Load changes, rated Input (Supply) Voltage changes, Initial Calibration Tolerance (25°C), Aging (1 year at 25°C Average Effective Ambient Temperature), Shock and Vibration.**

### Output Enable / Disable Function

| Parameter  | Min.               | Typ. | Max.               | Units | Notes          |
|--|--------------------|------|--------------------|-------|----------------|
| Input Voltage (Pin1), Output Enable                      | 0.7V <sub>DD</sub> |      |                    | V     | Or Open        |
| Input Voltage (Pin1), Output Disable (low power standby) |                    |      | 0.3V <sub>DD</sub> | V     | Output is Hi-Z |
| Internal Pullup Resistance                               | 30                 |      |                    | KΩ    |                |
| Output Disable Delay                                     |                    |      | 50                 | ns    |                |



# TYPE FK 3.2x2.5 SEAM SEALED CRYSTAL CLOCK OSCILLATOR

**FK3710003**

VER. B 18-May-18

## TEST CIRCUIT

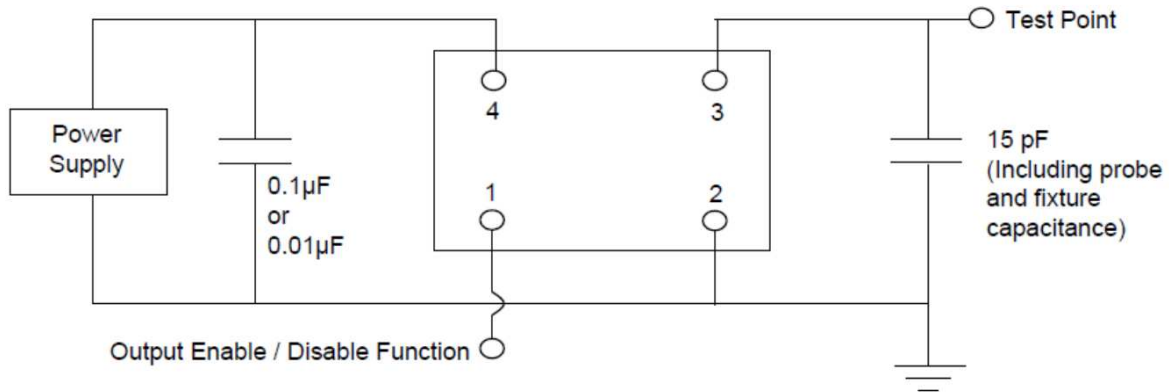

## OUTPUT WAVEFORM

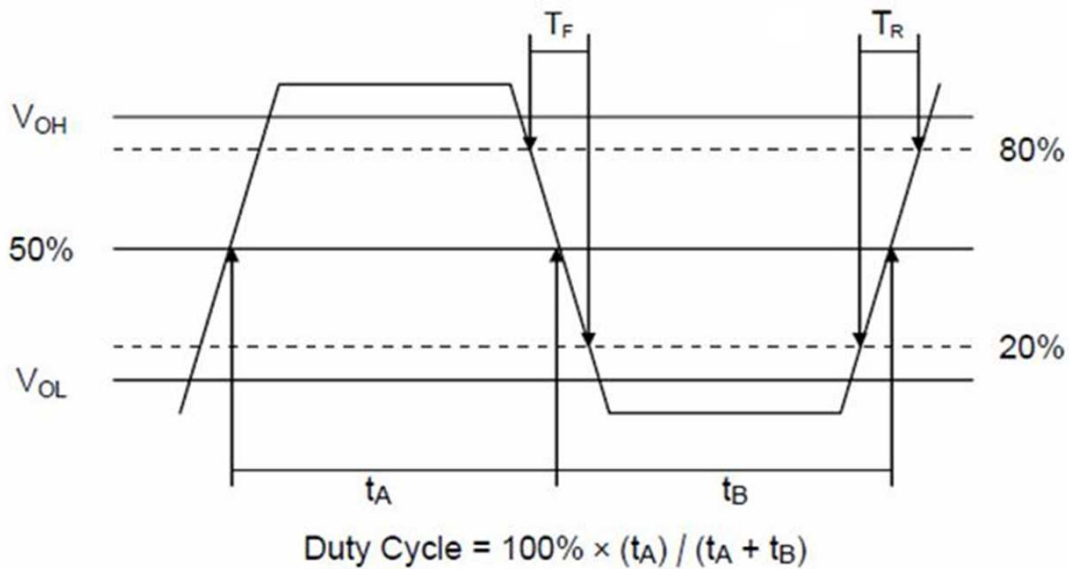

# TYPE FK 3.2x2.5 SEAM SEALED CRYSTAL CLOCK OSCILLATOR

**FK3710003**

VER. B 18-May-18

## RELIABILITY SPECIFICATIONS

### ENVIRONMENTAL:

- a) THERMAL SHOCK: MIL-STD-883, Method 1011, Condition A
- b) MOISTURE RESISTANCE: MIL-STD-883, Method 1004
- c) VIBRATION: MIL-STD-883, Method 2007, Condition A
- d) RESISTANCE TO SOLDERING HEAT: J-STD-020D Table 5-2 Pb-free devices (except 2 cycles max)
- e) HAZARDOUS SUBSTANCE: Pb - free and RoHS Compliant.

### MECHANICAL:

- a) SHOCK: MIL-STD-883, Method 2002, Condition B
- b) SOLDERABILITY: JESD22-B102-D Method 2 (Preconditioning E)
- c) TERMINAL STRENGTH: MIL-STD-883, Method 2004, Test Condition D
- d) GROSS LEAK: MIL-STD-883, Method 1014, Condition C
- e) FINE LEAK: MIL-STD-883, Method 1014, Condition A2,  $R1=2 \times 10^{-8}$  atm cc/s
- f) SOLVENT RESISTANCE: MIL-STD-202, Method 215

## SUGGESTED IR REFLOW PROFILE

\*As per IPC-JEDEC J-STD-020D

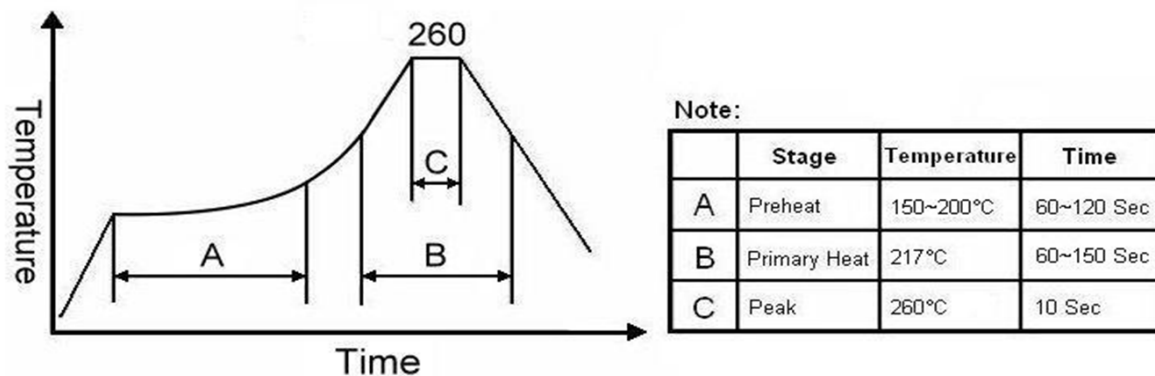

# TYPE FK 3.2x2.5 SEAM SEALED CRYSTAL CLOCK OSCILLATOR

**FK3710003**

VER. B 18-May-18

## MARKING

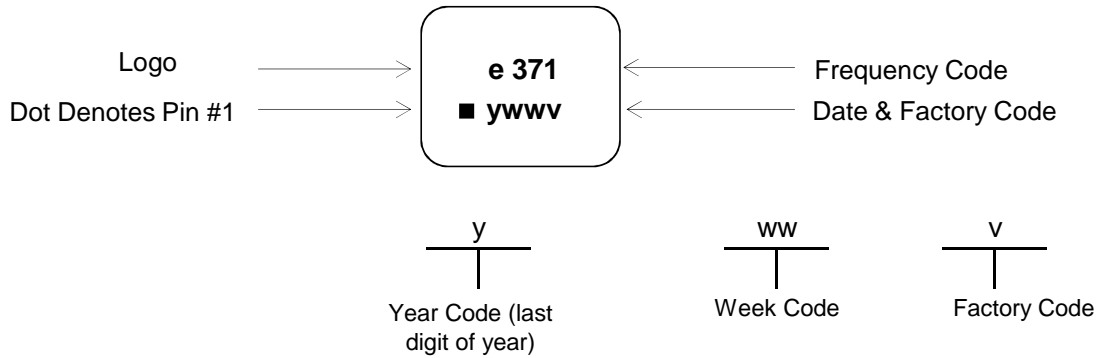

## MECHANICAL DRAWINGS ( Scale: None. Dimensions are in mm.)

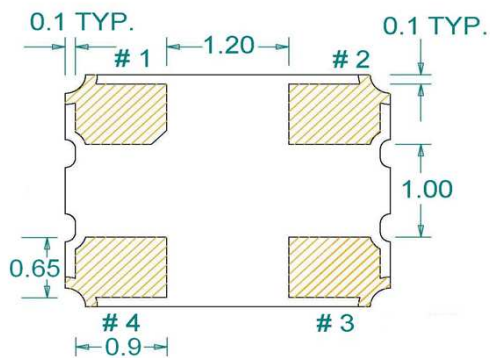
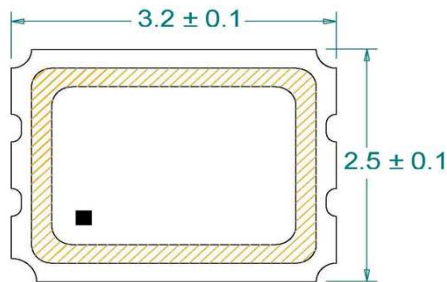

(Bottom View)

### Recommended Land Pattern\*

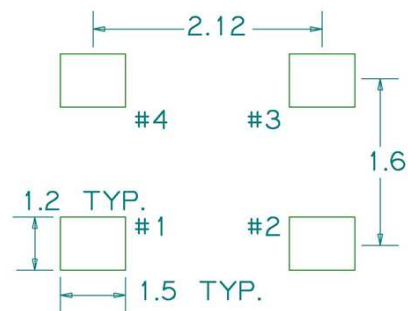

\*External high-frequency power decoupling is recommended. (see test circuit for minimum recommendation). To ensure optimal performance, do not route traces beneath the package.

| Pin | Function        |
|-----|-----------------|
| 1   | OE              |
| 2   | Ground          |
| 3   | Clock Output    |
| 4   | V <sub>DD</sub> |

# TYPE FK 3.2x2.5 SEAM SEALED CRYSTAL CLOCK OSCILLATOR

**FK3710003**

VER. B 18-May-18

## TAPE&REEL

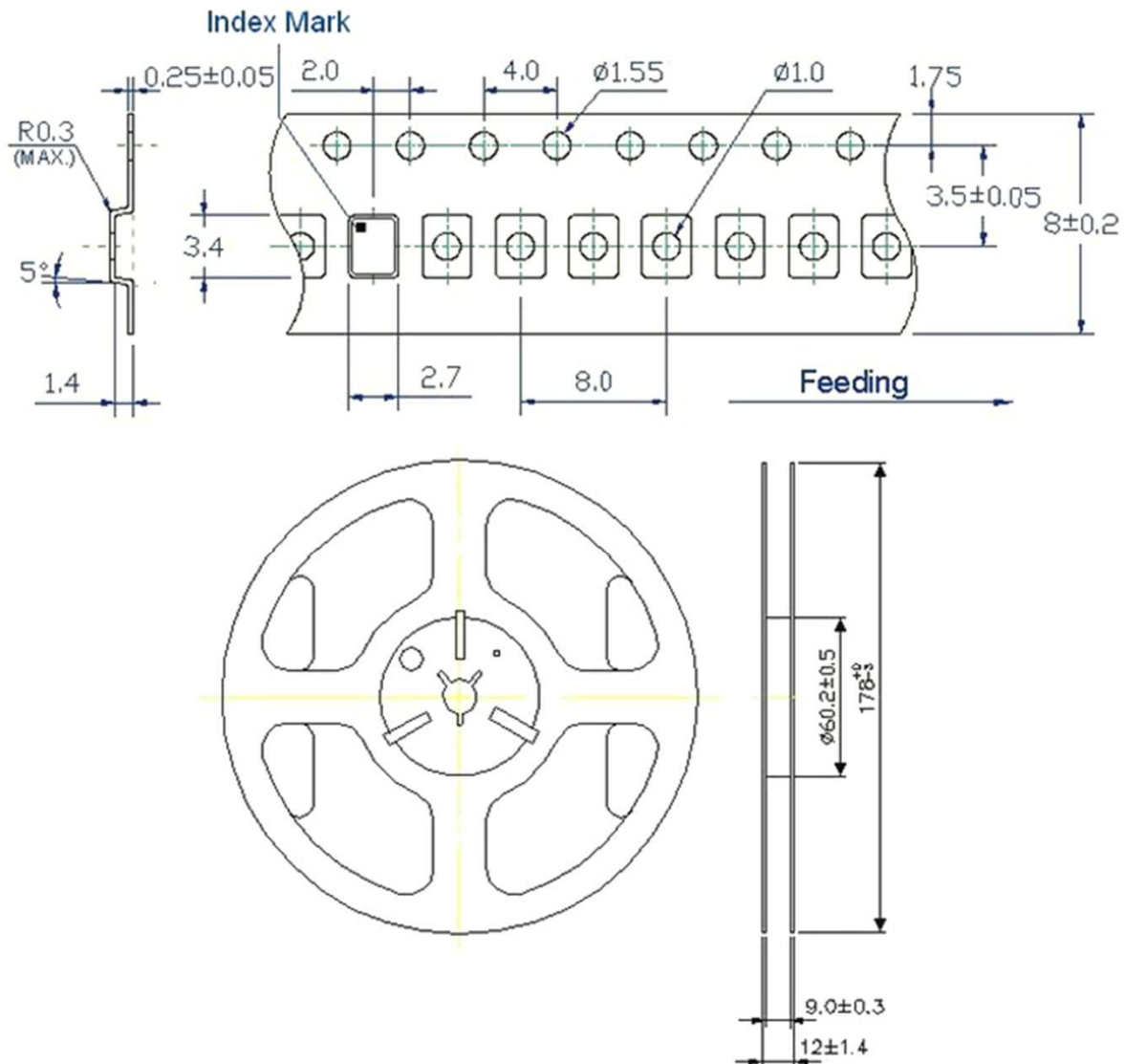

1. 230mm minimum leafer which consist of carrier and/or tape followed by a minimum of 160mm of empty carrier tape sealed with cover tape.
2. 160mm minimum trailer of empty carrier tape sealed with cover tape.

# TYPE FK 3.2x2.5 SEAM SEALED CRYSTAL CLOCK OSCILLATOR

**FK3710003**

VER. B 18-May-18

## PACKING

