

Description

This document describes the specifications for the F1792 Wideband, Gain-Settable, Zero-Distortion™ Flat-Noise™, RF to IF Downconverting Mixer.

The F1792 offers very low power consumption with excellent linearity. In addition to this the F1792 has four dynamically adjustable gain settings. The F1792 performance is exceptional across an extremely broad range of RF and IF frequencies. All of this makes it ideal for a myriad of applications including:

- 2G/3G/4G/5G/Multimode Remote Radio Units
- Point to Point μWave Backhaul systems
- Broadband Repeaters
- Public Safety Infrastructure
- Any radio system operating between 400MHz and 4000MHz

Competitive Advantage

F1792 offers maximum performance and flexibility at minimum power consumption. The unique and patented settable-gain feature allows it to be used in a very wide variety of radio card applications, even allowing for dynamic adjustment of gain to maximize performance on the fly. The extremely wide RF and IF bandwidths are achieved using a fixed BOM, all RF matching is internal to the device. The F1792 can function with as little as -6 dBm LO power. It also features a channel shutdown mode for ease of integration into high order TDD systems.

Block Diagram

Figure 1. Functional Block Diagram

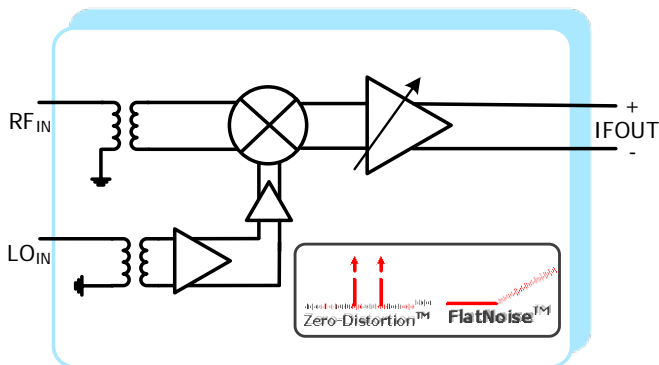

Features

- RF range: 400MHz to 3800MHz
- LO range: 400MHz to 3600MHz
- IF Range: 50MHz to 600MHz
- 4 Gain Settings; 11dB, 8dB, 5dB, 2dB
- 2 bit gain step control
- Ideal for Multi-Carrier Systems
- +35dBm OIP3
- Low Noise Figure at any gain setting via Renesas' FlatNoise™ technology
- Z = 200Ω IF balanced, 50Ω RF, 50Ω LO single-ended
- All internally matched. Single BOM for all RF, LO and IF frequencies
- 4 x 4 mm, 24-VFQFPN package
- Independent Path Standby mode
- 75 nsec settling for gain adjustment
- VCC = 3.3V, 462mW, 373mW (low power mode)

Band Performance Summary

RF Frequency (MHz)	900	1900	2600	3500
Gain (dB, max G11 setting)	11.0	10.8	10.3	9.0
Gain (dB, min G2 setting)	2.5	2.3	1.8	0.5
NF at max gain (dB)	8.9	8.7	10.0	10.9
IIP3 at min gain (dBm)	28	27	29	30
OIP3 at G8 (dBm)	37	34	35	35
IP1dB at min gain (dBm)	13.6	14.7	14.6	15.8
Pdiss (mW)	442	462	485	520

Pin Assignments

Figure 2. Pin Assignments for 4 x 4 mm 24-VFQFPN Package - Top View

Red denotes internal connection

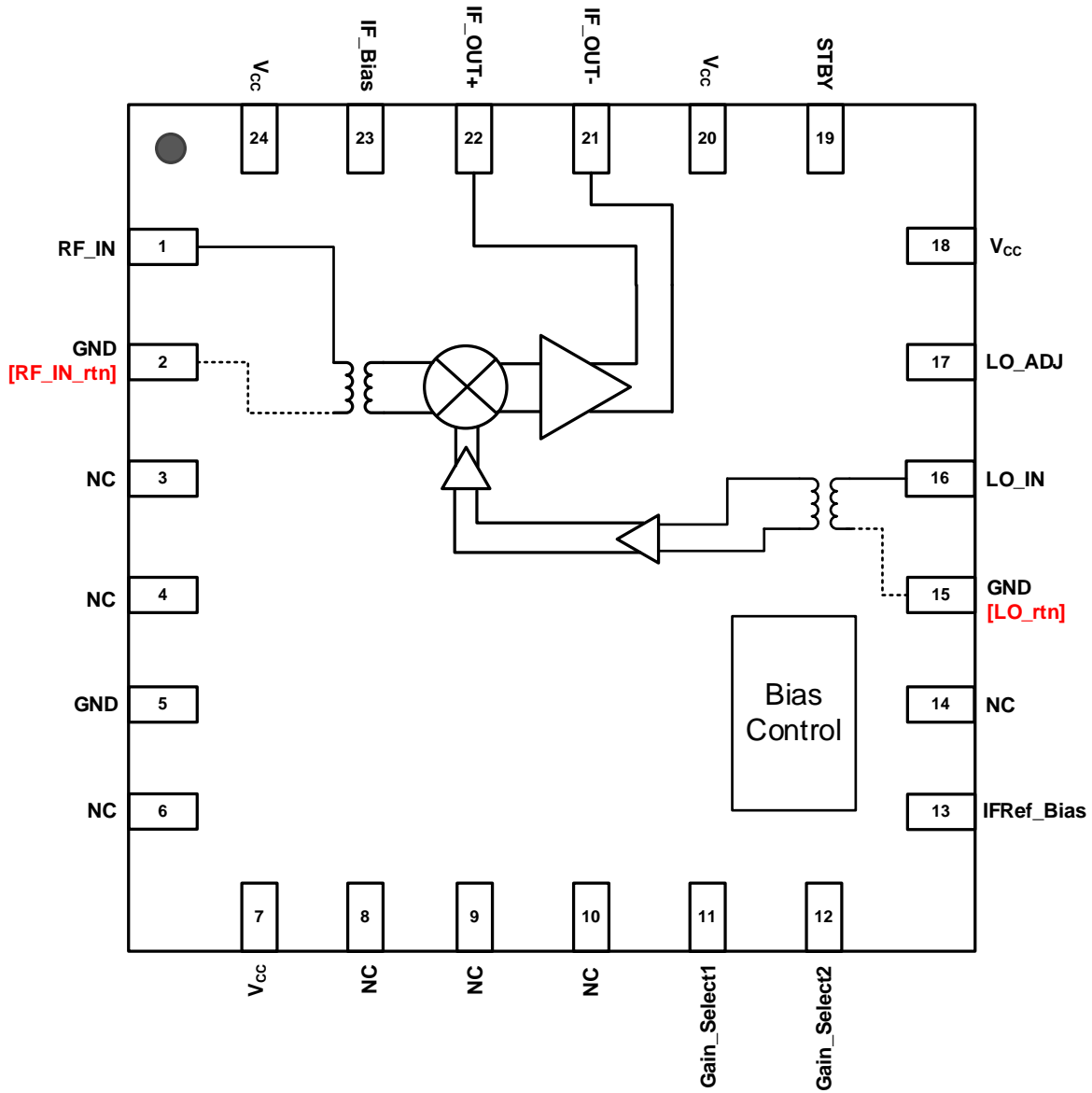

Pin Descriptions

Table 1. F1792 Pin Descriptions

Number	Name	Description
1	RF_IN	RF input. Matched to 50 ohms. DO NOT apply DC to this pin.
2	RF_IN_rtn	RF input transformer ground return. Ground this pin.
3, 4, 6, 8, 9, 10, 14	NC	Not connected.
5	GND	Ground this pin.
7, 18, 20, 24	VCC	Power Supply. Bypass to ground with appropriate capacitors as close as possible to pin
11	Gain_Select1	Gain select control pin, includes internal pull-down resistor. See gain select truth table for desired setting
12	Gain_Select2	Gain select control pin, includes internal pull-down resistor. See gain select truth table for desired setting
13	IFRef_Bias	Connect recommended resistor value from this pin to ground to set the IF amplifier reference current
15	LO_IN_rtn	LO input transformer ground return. Ground this pin.
16	LO_IN	Local Oscillator (LO) input. Matched to 50 ohms. DO NOT apply DC to this pin.
17	LO_ADJ	Connect zero ohm resistor to ground here for best performance
19	STBY	Standby Input (Low/Open = Power ON, High = Power OFF). Includes internal pull-down resistor
21, 22	IF_OUT-, IF_OUT+	Mixer Differential IF Output. Connect pull-up inductors from each of these pins to VCC (see the Typical Application Circuit)
23	IF_Bias	Connect the specified resistor from this pin to ground to set the bias for the Main IF amplifier
	— EP	Exposed Pad. Internally connected to GND. Solder this exposed pad to a PCB pad that uses multiple ground vias to provide heat transfer out of the device into the PCB ground planes. These multiple via grounds are also required to achieve the specified RF performance

Absolute Maximum Ratings

Table 2. Absolute Maximum Ratings

Parameter	Symbol	Conditions	Minimum	Maximum	Units
VCC to GND	V _{CC}		-0.5	+3.6	V
STBY, Gain_Select1, Gain_Select2, RF_IN, LO1_ADJ, LO2_ADJ	V _{CTRL}		-0.5	V _{CC} +0.5	V
IF_OUT+, IF_OUT-	I _{FOUT}		2.4	V _{CC} +0.5	V
LO_IN	LO _{IN}		-0.5	+0.5	V
IF_Bias	I _{FBIAS}			50	Ohms
IF_Ref_Bias	I _{FREF}			500	Ohms
RF Input Power	RF _{MAX}	continuous		20	dBm
LO Input Power	LO _{MAX}	continuous		20	dBm
Continuous Power Dissipation	P _{DISS}			1.5	W
Junction temperature	T _J	-	-	150	°C
Storage temperature	T _S	-	-65	150	°C
Lead temperature	T _{LEAD}	(soldering, 10 seconds)		260	°C
ESD – Human Body Model (JEDEC/ESDA JS-001-2012)	-	-	-	Class 2 (2500)	V
ESD – Charged Device Model (JEDEC 22-C101F)	-	-	-	Class C3 (1000)	V

Stresses above those listed above may cause permanent damage to the device. Functional operation of the device at these or any other conditions above those indicated in the operational section of this specification is not implied. Exposure to absolute maximum rating conditions for extended periods may affect device reliability

Recommended Operating Conditions

Table 3. Recommended Operating Conditions

Parameter	Symbol	Minimum	Typical	Maximum	Units
Power supply voltage	V _{CC}	3.15	-	3.45	V
Operating temperature range	T _{CASE}	-40	-	105	°C
RF Frequency Range	F _{RF}	400		3800	MHz
Local Oscillator (LO) Frequency Range	F _{LO}	400		3600	MHz
Intermediate Frequency (IF) Range	F _{IF}	50		600	MHz
Local oscillator power level	P _{LO}	-6		+6	dBm

Electrical Characteristics

Table 4. F1792 Specification (General)

Typical Application Circuit, $V_{CC} = +3.3V$, $T_C = +25^\circ C$, $F_{RF} = 900MHz$, $F_{IF} = 199MHz$, $F_{LO} = 1099MHz$, $P_{LO} = 0\text{ dBm}$, $P_{IN} = -10dBm$ per tone for all gain settings unless otherwise stated, STBY = LOW. EVkit IF transformer losses are de-embedded unless otherwise noted.

Parameter	Symbol	Conditions	Minimum	Typical	Maximum	Units
Logic Input High ³	V_{IH}^3	-	1.1'			V
Logic Input Low ³	V_{IL}^3	Minimum attenuation			0.65	V
Logic Current	I_{IH}, I_{IL}	For all control pins	-5		+100	uA
Supply Current	I_{CH_LB}	Low band LO		134	154	mA
Supply Current	I_{CH_MB}	Mid band LO		140	160	mA
Supply Current	I_{CH_HB}	High band LO		147	166	mA
Supply Current – reduced linearity		FRF = 2.2GHz, FLO = 2GHz OIP3 = +20dBm max gain IFRef_Bias resistor = 3.9Kohm		113	135	mA
Shutdown current	I_{SD}			3	6	mA
Settling Time	T_{SETT}	Pin = -13 dBm Gate STBY pin Time for IF Signal to settle from 50% STBY to within 90% of final value		340		nsec
		Pin = -13 dBm Gate STBY pin Time for IF Signal to settle from 50% STBY to within 0.1 dB of final value		920		nsec
		Pin = -13 dBm Gate Gain Select pins per Gain Control table Time for IF Signal to settle from 50% Gain Select to within 90% of final value		75		nsec
RFIN Impedance	Z_{RFIN}	Single-Ended		50		Ω
LO Port Impedance	Z_{LO}	Single-Ended		50		Ω
IF Output Impedance	Z_{IF}	Differential		200		Ω
IF Return Loss	RL_{IF}	Differential 200 ohm with 4:1 Balun		-15		dB
LO Return Loss	RL_{LO}	Single-Ended 50 ohm		-15		dB

NOTE 1: Items in min/max columns in **bold italics** are Guaranteed by Test.

NOTE 2: Items in min/max columns that are not bold/italics are Guaranteed by Design Characterization.

NOTE 3: JEDEC 3.3V and JEDEC 1.8V logic.

Table 5. F1792 Specification (Low Band)

Typical Application Circuit, $V_{CC} = +3.3V$, $T_C = +25^\circ C$, $F_{RF} = 900MHz$, $F_{IF} = 199MHz$, $F_{LO} = 1099MHz$, $P_{LO} = 0\text{ dBm}$, $P_{IN} = -10\text{dBm}$ per tone for all gain settings unless otherwise stated, $STBY = LOW$. EVkit IF transformer losses are de-embedded unless otherwise noted. Gain Setting = G_5 (~ 5 dB gain).

Parameter	Symbol	Conditions	Minimum	Typical	Maximum	Units
Power Gain	G_{11}	Gain setting = G_{11}		11.1		dB
	G_8	Gain setting = G_8		8.3		
	G_5	Gain setting = G_5	4.05	5.4	6.75¹	
	G_2	Gain setting = G_2		2.5		
G5 Gain Change over temp	$G5_{TempDrift}$	Tcase $-40^\circ C / +105^\circ C$ referenced to $+25^\circ C$		-0.7 / +0.7		dB
Gain Slope	$Gain_{SLOPE}$	IF center 200MHz 100MHz BW		+0.006		dB/MHz
Noise Figure	NF_{G11}	Gain setting = G_{11}		8.9		dB
	NF_{G8}	Gain setting = G_8		9.4		
	$NF_{G5}^{4,5}$	Gain setting = G_5		10.1	11.7 ²	
	NF_{G2}	Gain setting = G_2		10.7		
Input IP3	$IIP3_{G11}$	Gain setting = G_{11} 800kHz tone separation		24		dBm
	$IIP3_{G8}$	Gain setting = G_8 800kHz tone separation		29		
	$IIP3_{G5}^4$	Gain setting = G_5 800kHz tone separation	26	28		
	$IIP3_{G2}$	Gain setting = G_2 800kHz tone separation		28		
G3 IIP3 change over temp	$IIP3_{G3TempDrift}$	Tcase $-40^\circ C / +105^\circ C$ referenced to $+25^\circ C$		-2.6/+0.6		dB
Output IP3	$OIP3_{G11}$	Gain setting = G_{11} 800kHz tone separation		35		dBm
	$OIP3_{G8}$	Gain setting = G_8 800kHz tone separation		37		

NOTE 1: Items in min/max columns in ***bold italics*** are confirmed by Test.

NOTE 2: Items in min/max columns that are not bold/italics are confirmed by Design Characterization.

NOTE 3: JEDEC 3.3V and JEDEC 1.8V logic.

NOTE 4: Specification limits over voltage and temperature

NOTE 5: Max limit at Tcase = $+105^\circ C$.

Table 6. F1792 Specification (Low Band) Continued

Typical Application Circuit, $V_{CC} = +3.3V$, $T_C = +25^\circ C$, $F_{RF} = 900MHz$, $F_{IF} = 199MHz$, $F_{LO} = 1099MHz$, $P_{LO} = 0\text{ dBm}$, $P_{IN} = -10\text{dBm}$ per tone for all gain settings unless otherwise stated, $STBY = LOW$. EVkit IF transformer losses are de-embedded unless otherwise noted. Gain Setting = G_5 (~ 5 dB gain).

Parameter	Symbol	Conditions	Minimum	Typical	Maximum	Units
Output IP3	OIP3 _{G5}	Gain setting = G_5 800kHz tone separation		32		dBm
		Gain setting = G_5 $T_C = +105^\circ C$ LO power = -3dBm $V_{CC} = 3.15V$	33	34		
	OIP3 _{G2}	Gain setting = G_2 800kHz tone separation		30		
Input P1dB	IP1dB _{G11}	Gain setting = G_{11} IF_B Pout versus IF_A w/ RF_A input		7.0		dB
	IP1dB _{G8}	Gain setting = G_8		9.2		
	IP1dB _{G5} ⁴	Gain setting = G_5	10.4	11.8		
	IP1dB _{G2}	Gain setting = G_2		13.6		
Maximum saturated output power	P_{sat}	P_{in} up to +20dBm		17		dBm
LO to IF leakage	ISO _{LI}		47	48		dBm
2LO to IF leakage	ISO _{LI2}			-38	-35	dBm
3LO to IF leakage	ISO _{LI3}			-25		dBm
4LO to IF leakage	ISO _{LI4}			-49		dBm
RF to IF leakage	ISO _{RI}	RF output power compared to measured IF output power		-25	-23	dBc
LO to RF leakage	ISO _{LR}			-52		dBm
RF Return Loss	RL _{RF}	Single-Ended 50 ohm		-12		dB

NOTE 1: Items in min/max columns in ***bold italics*** are confirmed by Test.

NOTE 2: Items in min/max columns that are not bold/italics are confirmed by Design Characterization.

NOTE 3: JEDEC 3.3V and JEDEC 1.8V logic.

NOTE 4: Specification limits over voltage and temperature.

NOTE 5: Max limit at $T_{case} = +105^\circ C$.

Table 7. F1792 Specification (Mid Band)

Typical Application Circuit, $V_{CC} = +3.3V$, $T_C = +25^\circ C$, $F_{RF} = 1900MHz$, $F_{IF} = 199MHz$, $F_{LO} = 1701MHz$, $P_{LO} = 0 dBm$, $P_{IN} = -10dBm$ per tone for all gain settings unless otherwise stated, STBY = LOW. EVkit IF transformer losses are de-embedded unless otherwise noted. Gain Setting = G_5 (~ 5 dB gain).

Parameter	Symbol	Conditions	Minimum	Typical	Maximum	Units
Power Gain	G_{11}	Gain setting = G_{11}		10.8		dB
	G_8	Gain setting = G_8		8.1		
	G_5	Gain setting = G_5	3.75	5.1	6.45¹	
	G_2	Gain setting = G_2		2.3		
G5 Gain Change over temp	$G5_{TempDrift}$	Tcase $-40^\circ C / +105^\circ C$ referenced to $+25^\circ C$		-0.6 / +0.7		dB
Gain Slope	$Gain_{SLOPE}$	IF center 200MHz 100MHz BW		+0.006		dB/MHz
Noise Figure	NF_{G11}	Gain setting = G_{11}		8.7		dB
	NF_{G8}	Gain setting = G_8		9.1		
	$NF_{G5}^{4,5}$	Gain setting = G_5		9.8	11.4 ²	
	NF_{G2}	Gain setting = G_2		10.7		
Blocking Noise Figure	NF_{BLK}	Gain setting = G_{11} +100MHz offset blocker $P_{in} = +4 dBm$		17		dB
Input IP3	$IIP3_{G11}$	Gain setting = G_{11} 800kHz tone separation		23		dBm
	$IIP3_{G8}$	Gain setting = G_8 800kHz tone separation		25		
	$IIP3_{G5}^4$	Gain setting = G_5 800kHz tone separation	25	26		
	$IIP3_{G2}$	Gain setting = G_2 800kHz tone separation		27		
G3 IIP3 change over temp	$IIP3_{G3TempDrift}$	Tcase $-40^\circ C / +105^\circ C$ referenced to $+25^\circ C$		-0.2/+5		dB
Output IP3	$OIP3_{G11}$	Gain setting = G_{11} 800kHz tone separation		33.6		dBm
	$OIP3_{G8}$	Gain setting = G_8 800kHz tone separation		33.6		

NOTE 1: Items in min/max columns in **bold italics** are confirmed by Test.

NOTE 2: Items in min/max columns that are not bold/italics are confirmed by Design Characterization.

NOTE 3: JEDEC 3.3V and JEDEC 1.8V logic.

NOTE 4: Specification limits over voltage and temperature.

NOTE 5: Max limit at Tcase = $+105^\circ C$.

Table 8. F1792 Specification (Mid Band) Continued

Typical Application Circuit, $V_{CC} = +3.3V$, $T_C = +25^\circ C$, $F_{RF} = 1900MHz$, $F_{IF} = 199MHz$, $F_{LO} = 1701MHz$, $P_{LO} = 0\text{ dBm}$, $P_{IN} = -10\text{dBm}$ per tone for all gain settings unless otherwise stated, STBY = LOW. EVkit IF transformer losses are de-embedded unless otherwise noted. Gain Setting = G_5 (~ 5 dB gain).

Parameter	Symbol	Conditions	Minimum	Typical	Maximum	Units
	OIP3 _{G5}	Gain setting = G_5 800kHz tone separation	29	31.0		
		Gain setting = G_5 $T_C = +105^\circ C$ LO power = -3dBm $V_{CC} = 3.15V$	28.8	29.5		
	OIP3 _{G2}	Gain setting = G_2 800 kHz tone separation		29.0		
Input P1dB	IP1dB _{G11}	Gain setting = G_{11}	6.0	7.7		dB
	IP1dB _{G8}	Gain setting = G_8		10.1		
	IP1dB _{G5} ⁴	Gain setting = G_5	11.3	12.7		
	IP1dB _{G2}	Gain setting = G_2		14.7		
Maximum saturated output power	P_{sat}	P_{in} up to +20dBm		17		dBm
LO to IF leakage	ISO _{LI}			-31	-22	dBm
2LO to IF leakage	ISO _{LI2}			-20		dBm
3LO to IF leakage	ISO _{LI3}			-59		dBm
4LO to IF leakage	ISO _{LI4}			-44		dBm
RF to IF leakage	ISO _{RI}	RF output power compared to measured IF output power		-25	-20	dBc
LO to RF leakage	ISO _{LR}			-46		dBm
RF Return Loss	RL _{RF}	Single-Ended 50 ohm		-13		dB

NOTE 1: Items in min/max columns in **bold italics** are confirmed by Test.

NOTE 2: Items in min/max columns that are not bold/italics are confirmed by Design Characterization.

NOTE 3: JEDEC 3.3V and JEDEC 1.8V logic.

NOTE 4: Specification limits over voltage and temperature.

NOTE 5: Max limit at Tcase = +105°C.

Table 9. F1792 Specification (High Band)

Typical Application Circuit, $V_{CC} = +3.3V$, $T_C = +25^\circ C$, $F_{RF} = 2600MHz$, $F_{IF} = 199MHz$, $F_{LO} = 2401MHz$, $P_{LO} = 0 dBm$, $P_{IN} = -10dBm$ per tone for all gain settings unless otherwise stated, $STBY = LOW$. EVkit IF transformer losses are de-embedded unless otherwise noted. Gain Setting = G_5 (~ 5 dB gain).

Parameter	Symbol	Conditions	Minimum	Typical	Maximum	Units
Power Gain	G_{11}	Gain setting = G_{11}		10.3		dB
	G_8	Gain setting = G_8		7.5		
	G_5	Gain setting = G_5	3.25	4.6	5.95¹	
		Gain setting = G_5 $F_{IF} = 469MHz$ $F_{LO} = 2130MHz$	2.4	4.0	5.6	
	G_2	Gain setting = G_2		1.8		
G5 Gain Change over temp	$G5_{TempDrift}$	Tcase $-40^\circ C / +105^\circ C$ referenced to $+25^\circ C$		-0.7 / +0.7		dB
Gain Slope	$Gain_{SLOPE1}$	IF center 200MHz 100MHz BW		+0.006		dB/MHz
	$Gain_{SLOPE2}$	IF center 370MHz 200MHz BW		+0.008		dB/MHz
Noise Figure	NF_{G11}	Gain setting = G_{11}		10.0		dB
	NF_{G8}	Gain setting = G_8		10.4		
	$NF_{G5}^{4,5}$	Gain setting = G_5		11.1	13 ²	
		Gain setting = G_5 $F_{IF} = 469MHz$ $F_{LO} = 2130MHz$		11.8		
	NF_{G2}	Gain setting = G_2		11.9		
Input IP3	$IIP3_{G11}$	Gain setting = G_{11} 800kHz tone separation		24		dBm
	$IIP3_{G8}$	Gain setting = G_8 800kHz tone separation		28		
	$IIP3_{G5}^4$	Gain setting = G_5 800kHz tone separation	25	28		
	$IIP3_{G2}$	Gain setting = G_2 800kHz tone separation		29		
G3 IIP3 change over temp	$IIP3_{G3TempDrift}$	Tcase $-40^\circ C / +105^\circ C$ referenced to $+25^\circ C$		-0.8/+1.8		dB

NOTE 1: Items in min/max columns in **bold italics** are confirmed by Test.

NOTE 2: Items in min/max columns that are not bold/italics are confirmed by Design Characterization.

NOTE 3: JEDEC 3.3V and JEDEC 1.8V logic.

NOTE 4: Specification limits over voltage and temperature.

NOTE 5: Max limit at Tcase = $+105^\circ C$.

Table 10. F1792 Specification (High Band) Continued (-1-)

Typical Application Circuit, $V_{CC} = +3.3V$, $T_C = +25^\circ C$, $F_{RF} = 2600MHz$, $F_{IF} = 199MHz$, $F_{LO} = 2401MHz$, $P_{LO} = 0\text{ dBm}$, $P_{IN} = -10\text{ dBm}$ per tone for all gain settings unless otherwise stated, STBY = LOW. EVkit IF transformer losses are de-embedded unless otherwise noted. Gain Setting = G_5 (~ 5 dB gain).

Parameter	Symbol	Conditions	Minimum	Typical	Maximum	Units
Output IP3	OIP3 _{G11}	Gain setting = G_{11} 800kHz tone separation		34.7		dBm
	OIP3 _{G8}	Gain setting = G_8 800kHz tone separation		35.4		
	OIP3 _{G5}	Gain setting = G_5 800kHz tone separation		32.5		dBm
		Gain setting = G_5 $T_C = +105^\circ C$ LO power = -3dBm $V_{CC} = 3.15V$	28.4	29.3		
		Gain setting = G_5 $F_{IF} = 469MHz$ $F_{LO} = 2130MHz$		31.0		
	OIP3 _{G2}	Gain setting = G_2 800 kHz tone separation		30.5		
Input P1dB	IP1dB _{G11}	Gain setting = G_{11}		8.3		dBm
	IP1dB _{G8}	Gain setting = G_8		10.8		
	IP1dB _{G5} ⁴	Gain setting = G_5	11.8	13.2		
		Gain setting = G_5 $F_{IF} = 469MHz$ $F_{LO} = 2130MHz$		13.1		
	IP1dB _{G2}	Gain setting = G_2		14.6		
Maximum saturated output power	P_{sat}	P_{in} up to +20dBm		17		dBm
LO to IF leakage	ISO _{LI}			-40	-38	dBm
2LO to IF leakage	ISO _{LI2}			-44		dBm

NOTE 1: Items in min/max columns in ***bold italics*** are confirmed by Test.

NOTE 2: Items in min/max columns that are not bold/italics are confirmed by Design Characterization.

NOTE 3: JEDEC 3.3V and JEDEC 1.8V logic.

NOTE 4: Specification limits over voltage and temperature.

NOTE 5: Max limit at $T_{case} = +105^\circ C$.

Table 11. F1792 Specification (High Band) Continued (-2-)

Typical Application Circuit, $V_{CC} = +3.3V$, $T_C = +25^{\circ}C$, $F_{RF} = 2600MHz$, $F_{IF} = 199MHz$, $F_{LO} = 2401MHz$, $P_{LO} = 0\text{ dBm}$, $P_{IN} = -10dBm$ per tone for all gain settings unless otherwise stated, STBY = LOW. EVkit IF transformer losses are de-embedded unless otherwise noted. Gain Setting = G_5 (~ 5 dB gain).

Parameter	Symbol	Conditions	Minimum	Typical	Maximum	Units
3LO to IF leakage	ISO_{LI3}			-68		dBm
4LO to IF leakage	ISO_{LI4}			-71		dBm
RF to IF leakage	ISO_{RI}	RF output power compared to measured IF output power		-51	-30	dBc
LO to RF leakage	ISO_{LR}			-51		dBm
RF Return Loss	RL_{RF}	Single-Ended 50 ohm		-17		dB

NOTE 1: Items in min/max columns in ***bold italics*** are confirmed by Test.

NOTE 2: Items in min/max columns that are not bold/italics are confirmed by Design Characterization.

NOTE 3: JEDEC 3.3V and JEDEC 1.8V logic.

NOTE 4: Specification limits over voltage and temperature.

NOTE 5: Max limit at $T_{case} = +105^{\circ}C$.

Thermal Characteristics

Table 12. Package Thermal and Moisture Characteristics

Symbol	Parameter	Value	Units
θ_{JA}	Theta JA. Junction to ambient.	45 ^a	°C/W
θ_{JC}	Theta JC. Junction to case.	2.1	°C/W
-	Moisture Sensitivity Rating (Per J-STD-020)	MSL 1	-

Typical Performance Characteristics

Typical Operating Conditions (TOC)

Unless otherwise noted, the following apply to the Typ Ops Graphs

- High Side Injection for RF frequencies below 1.2GHz
- Low Side Injection for RF frequencies from 1.3 to 2.7 GHz
- 199MHz IF
- 800kHz Tone Spacing
- All measurements fully de-embedded for trace, connector, transformer losses
- Pin = -10dBm for Gain
- Pout = 0 dBm/Tone for IP3
- LO level = 0 dBm, VCC = 3.30V
- Listed Temperatures are Case Temperature (TC = Case Temperature)
- Where noted, TA or TAMB = Ambient Temperature]

NxM (dBc, Gset=5 dB, LO=1700 MHz, IF=200 MHz, RFfund=0 dBm at 1900 MHz, RFspur(MHz)=(N*LO(MHz)+IF(MHz))/M)											
		N (LO)									
		1	2	3	4	5	6	7	8	9	10
M (RF)	1	0.0	37.7	22.0	64.3	39.4	73.3	52.4			
	2	54.3	69.5	53.7	64.2	50.4	57.0	61.3	71.8	62.1	88.7
	3	61.8	73.1	56.0	78.6	60	79.1	69.2	83.8	82.2	96.4
	4	68.0	88.8	94.4	91.5	97.2	96.7	87.7	94.1	87.1	98.7
	5	>99	>99	81.1	95.7	94.9	97.8	94.9	>99	86.6	97.3
	6	>99	>99	>99	>99	>99	>99	>99	>99	>99	>99
	7	>99	>99	>99	>99	>99	>99	>99	>99	>99	>99
	8	>99	>99	>99	>99	>99	>99	>99	>99	>99	>99
	9	>99	>99	>99	>99	>99	>99	>99	>99	>99	>99
	10	>99	>99	>99	>99	>99	>99	>99	>99	>99	>99

NxM (dBc, Gset=5 dB, LO=1700 MHz, IF=200 MHz, RFfund=0 dBm at 1500 MHz, RFspur(MHz)=(N*LO(MHz)+IF(MHz))/M)											
		N (LO)									
		1	2	3	4	5	6	7	8	9	10
M (RF)	1	0.0	42.1	19.0	61.0	36.5	77.2	50.1			
	2	49.0	72.4	57.0	60.0	53.9	57.1	63.1	68.0	62.5	85.7
	3	69.8	78.6	51.5	75.9	62.1	75.3	66.0	84.5	76.2	91.4
	4	72.9	86.3	98.3	91.1	97.5	>99	88.2	95.8	93.2	>99
	5	>99	>99	85.2	96.9	86.7	>99	93.2	98.2	88.6	98.3
	6	>99	>99	>99	>99	>99	>99	>99	>99	>99	>99
	7	>99	>99	>99	>99	>99	>99	>99	>99	>99	>99
	8	>99	>99	>99	>99	>99	>99	>99	>99	>99	>99
	9	>99	>99	>99	>99	>99	>99	>99	>99	>99	>99
	10	>99	>99	>99	>99	>99	>99	>99	>99	>99	>99

TOCs (-1-) Fixed IF = 199MHz – IIP3, OIP3, and Gain

Figure 3. IIP3 vs. Temperature and Gain Setting

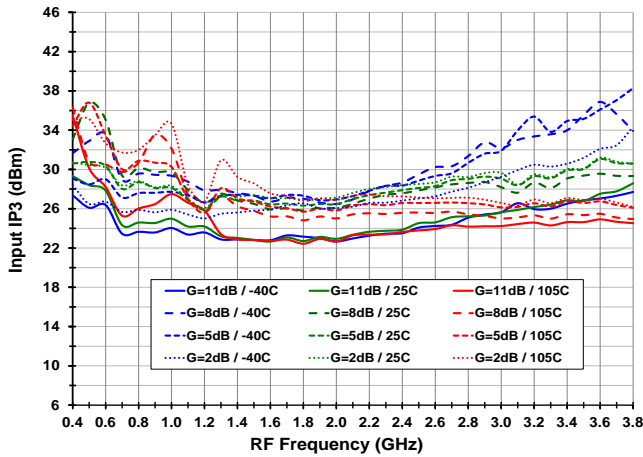

Figure 4. OIP3 vs. Temperature and Gain Setting

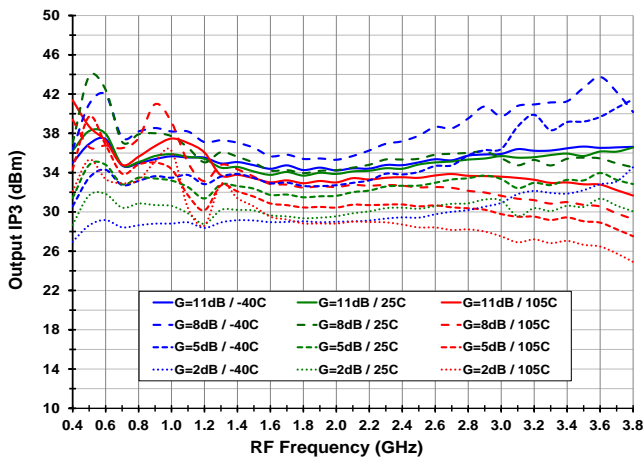

Figure 5. Gain vs. Temperature and Gain Setting

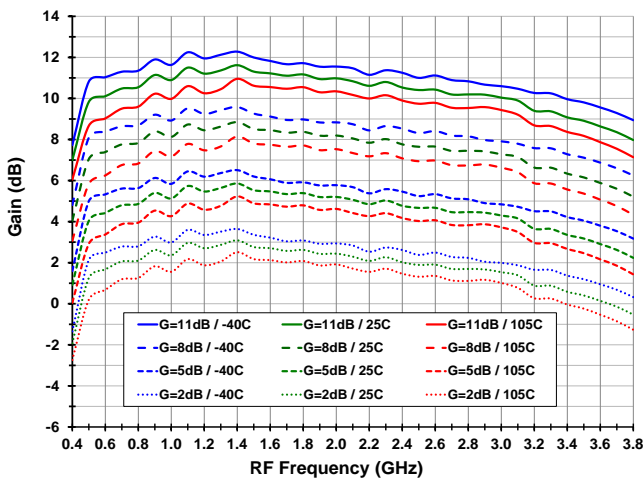

Figure 6. IIP3 vs. LO Power and Gain Setting (Vcc = 3.15, Tcase = 105°C)

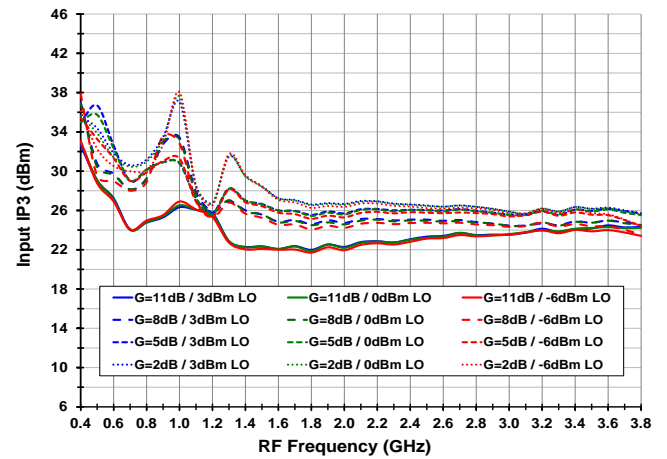

Figure 7. OIP3 vs. LO Power and Gain Setting (Vcc = 3.15, Tcase = 105°C)

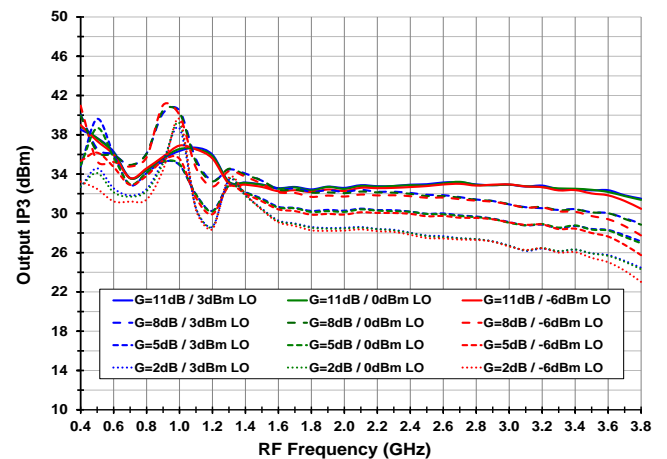
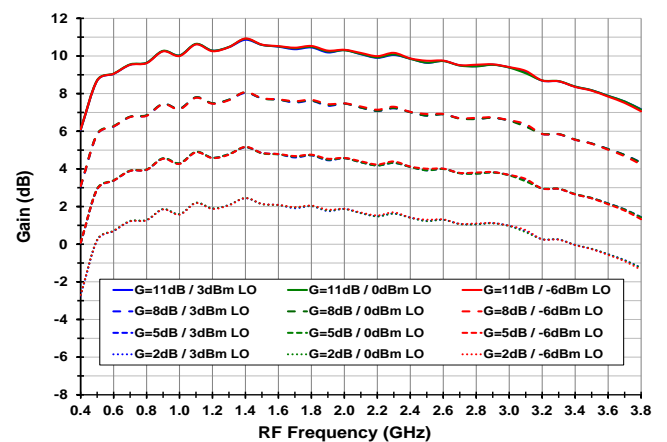

Figure 8. Gain vs. LO Power and Gain Setting (Vcc = 3.15, Tcase = 105°C)



TOCs (-2-) Fixed IF = 199MHz – P1dB

Figure 9. Input P1dB vs. Temperature and Gain Setting

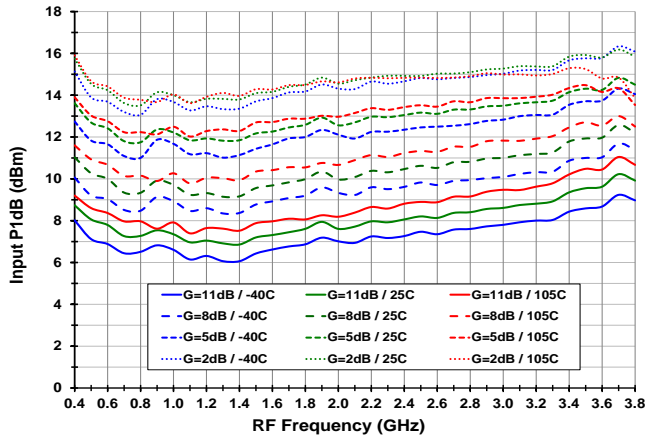
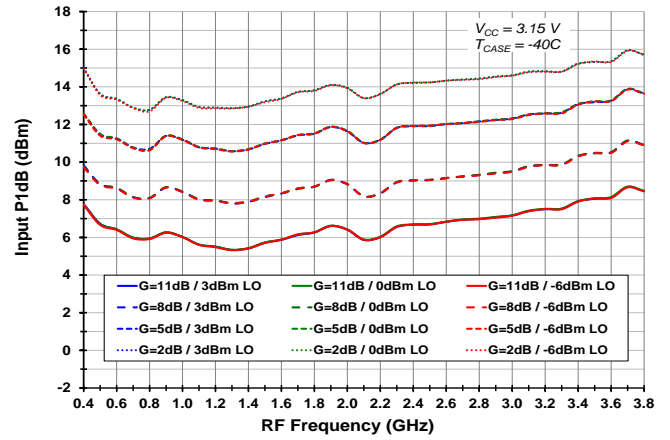

Figure 10. Input P1dB vs. LO Level and Gain Setting (Vcc = 3.15, Tcase = -40°C)



TOCs (-3-) Fixed IF=199MHz – Power Consumption, LO to IF Leakage, and RF to IF

Figure 11. Power Consumption vs. Temperature and Gain Setting

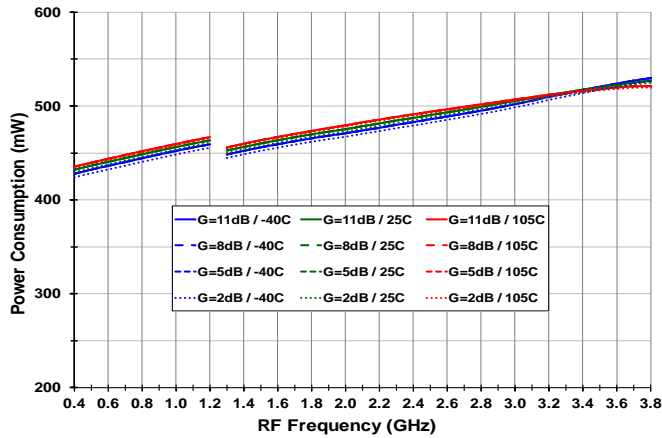

Figure 12. Power Consumption vs. Temperature and Gain Setting (V_{CC} = 3.15, T_{case} = 105°C)

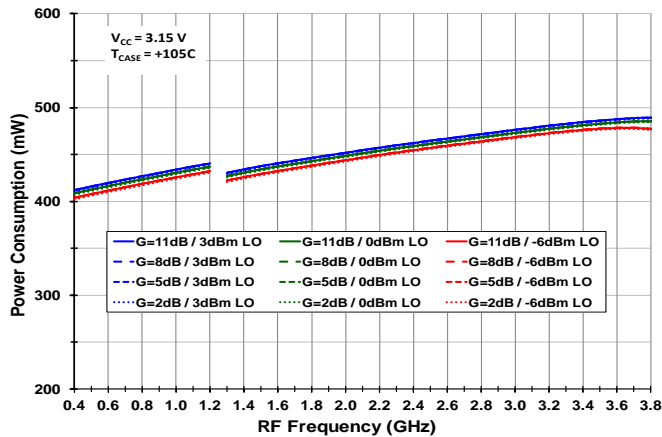

Figure 13. Power Consumption vs. Temperature and Gain Setting (V_{CC} = 3.45, T_{case} = -40°C)

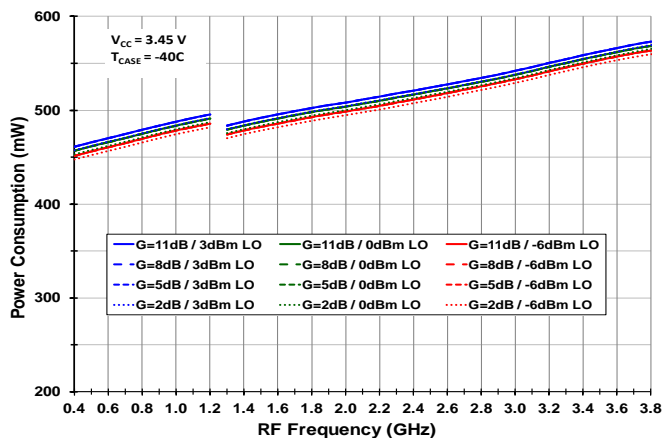

Figure 14. LO to IF Leakage vs. Temperature and Gain Setting

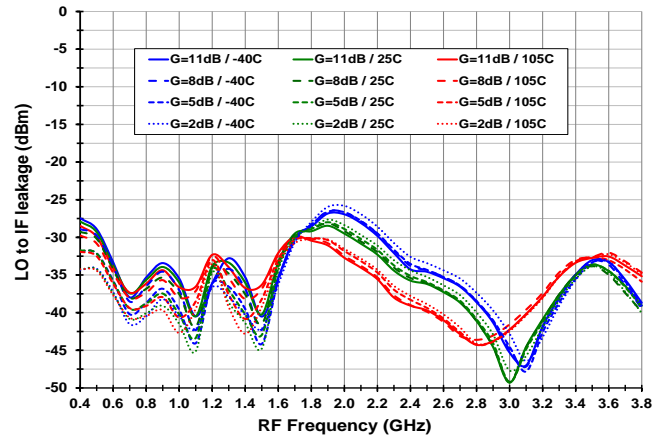
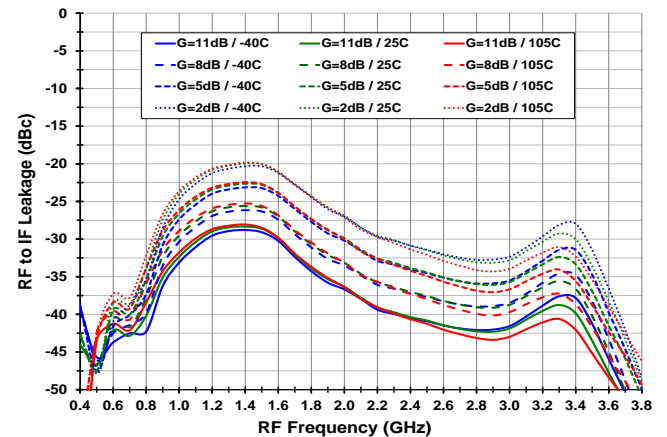

Figure 15. RF to IF Leakage vs. Temperature and Gain Setting



TOCs (-4-) Fixed IF=199MHz – Output IP2, Noise Figure

Figure 16. Output IP2 vs. Temperature and Gain Setting

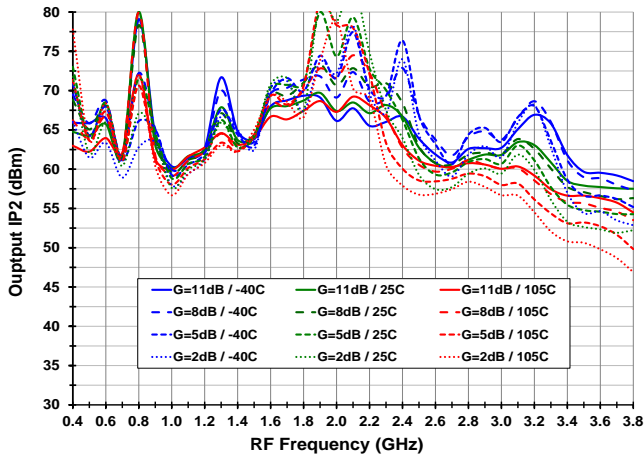

Figure 18. Output IP2 vs. Temperature and Gain Setting (Vcc = 3.15, Tcase = 105°C)

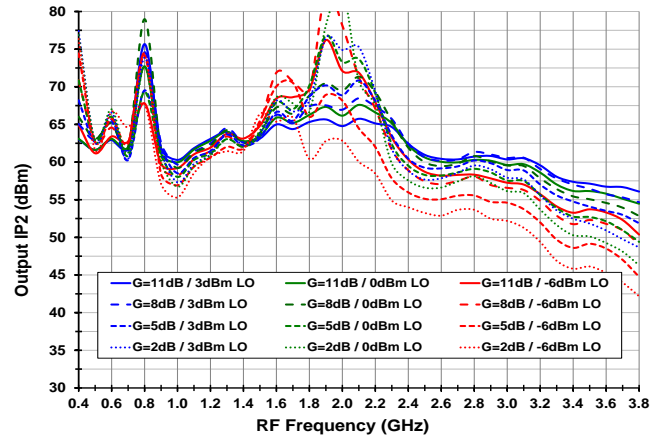

Figure 17. Noise Figure vs. Temperature and Gain Setting

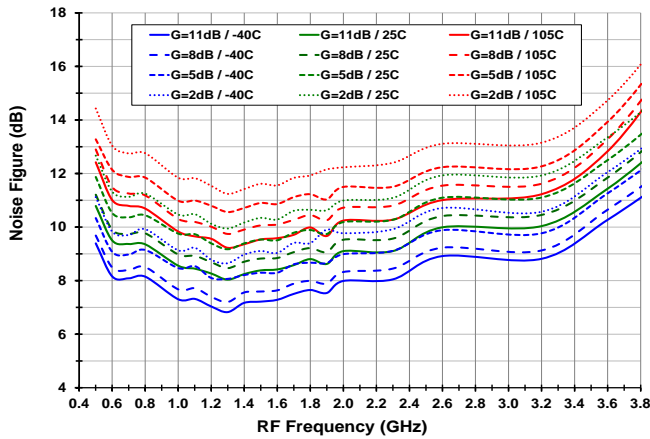
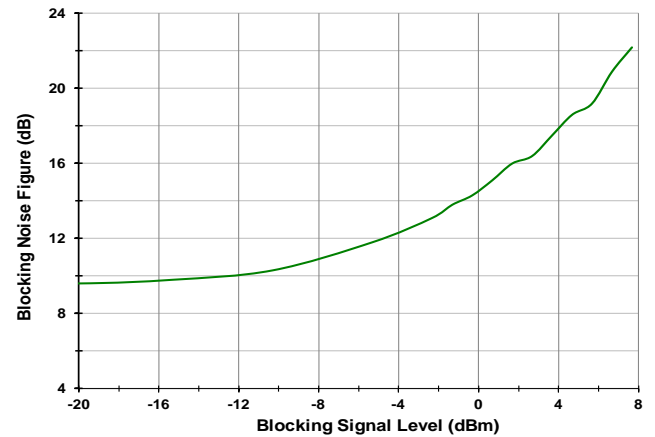

Figure 19. Blocking Noise Figure (Max Gain, LO=1700MHz, RF=1899MHz, Blocker=1999MHz, 25°C ambient)



TOCs (-5-) Fixed LO = 1.1GHz, 1.7GHz, 2.25GHz, 3.13GHz – Input IP3

Figure 20. Input IP3 vs. Temperature and Gain Setting (LO=1.1GHz)

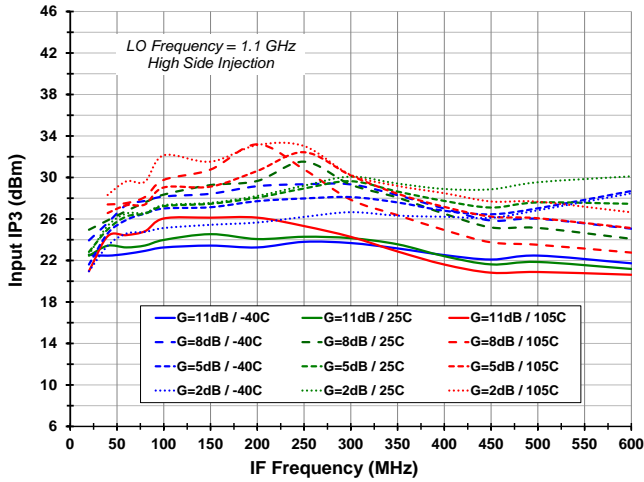

Figure 22. Input IP3 vs. Temperature and Gain Setting (LO=2.25GHz)

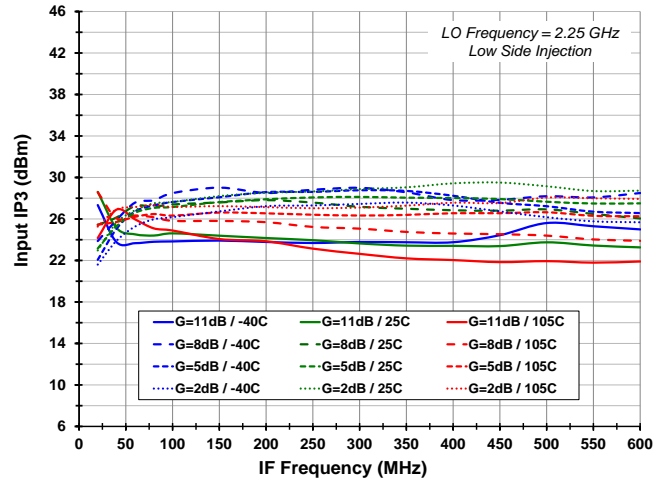

Figure 21. Input IP3 vs. Temperature and Gain Setting (LO=1.7GHz)

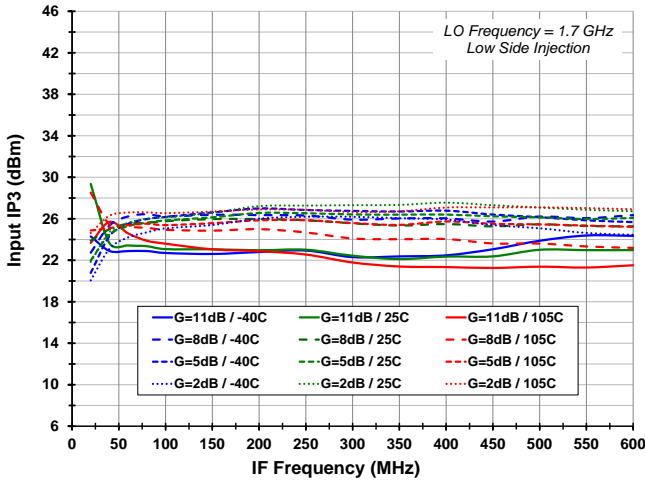
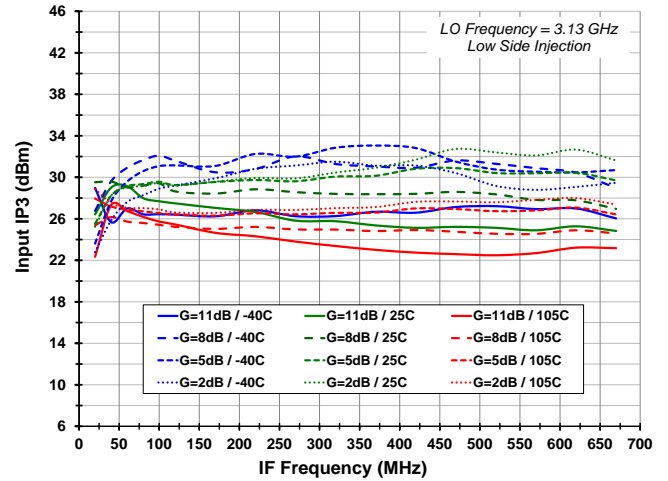

Figure 23. Input IP3 vs. Temperature and Gain Setting (LO=3.13GHz)



TOCs (-6-) Fixed LO = 1.1GHz, 1.7GHz, 2.25GHz, 3.13GHz – Output IP3

Figure 24. Output IP3 vs. Temperature and Gain Setting (LO=1.1GHz)

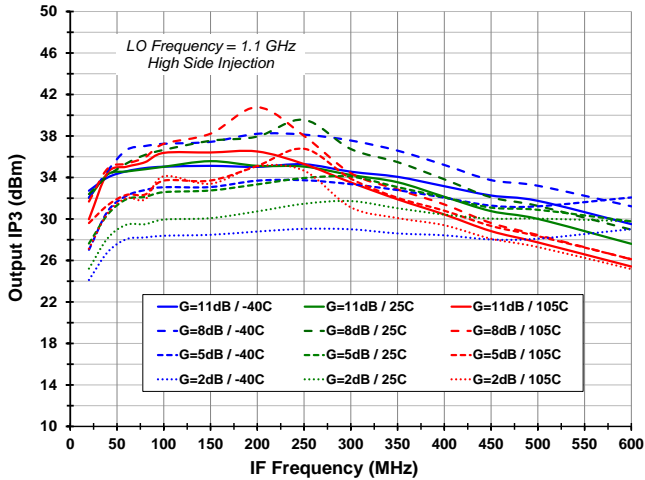

Figure 26. Output IP3 vs. Temperature and Gain Setting (LO=2.25GHz)

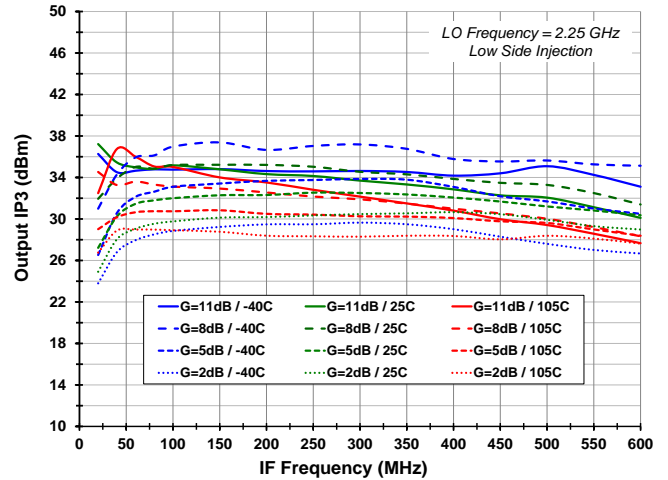

Figure 25. Output IP3 vs. Temperature and Gain Setting (LO=1.7GHz)

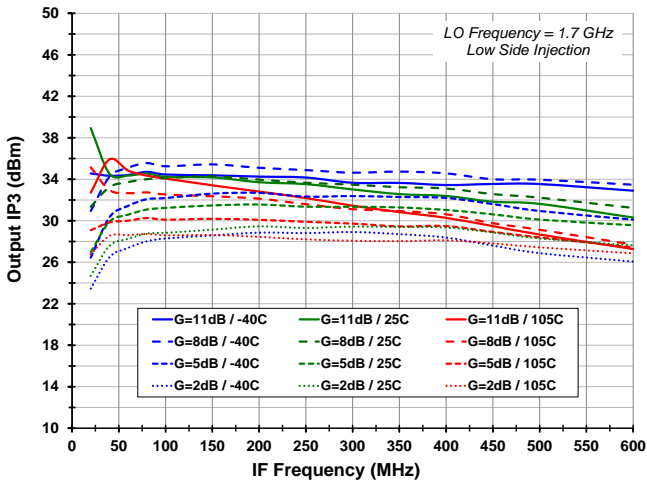
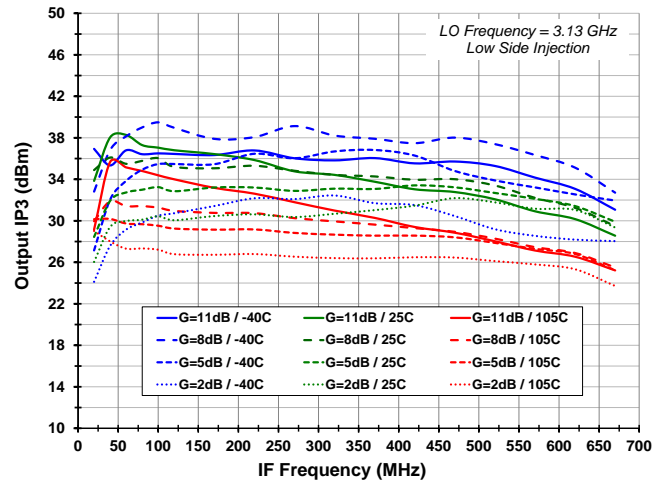

Figure 27. Output IP3 vs. Temperature and Gain Setting (LO=3.13GHz)



TOCs (-7-) Fixed LO = 1.1GHz, 1.7GHz, 2.25GHz, 3.13GHz – Gain

Figure 28. Gain vs. Temperature and Gain Setting (LO=1.1GHz)

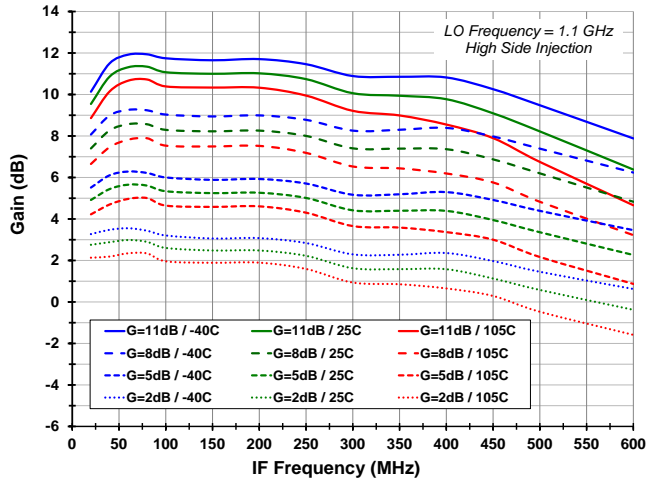

Figure 30. Gain vs. Temperature and Gain Setting (LO=2.25GHz)

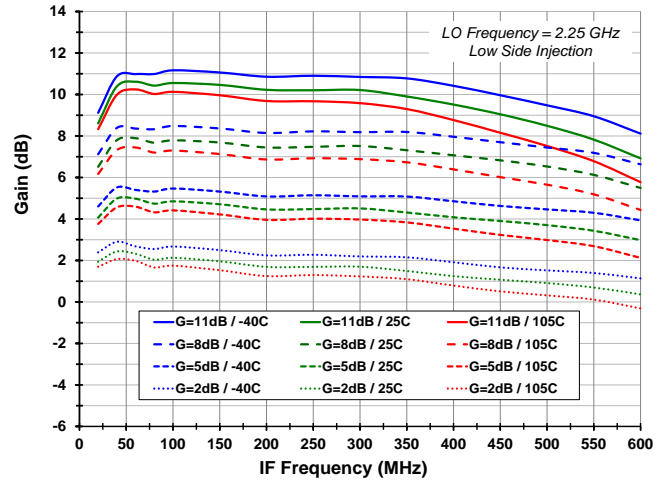

Figure 29. Gain vs. Temperature and Gain Setting (LO=1.7GHz)

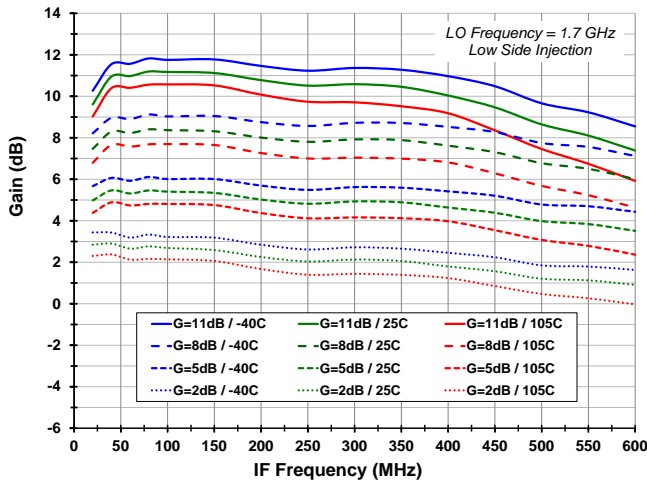
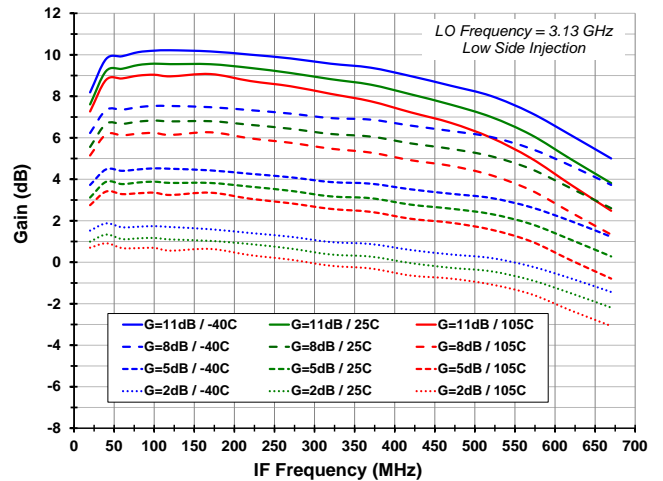

Figure 31. Gain vs. Temperature and Gain Setting (LO=3.13GHz)



TOCs (-8-) Fixed LO = 1.1GHz, 1.7GHz, 2.25GHz, 3.13GHz – Input P1dB

Figure 32. Input P1dB vs. Temperature and Gain Setting (LO=1.1GHz)

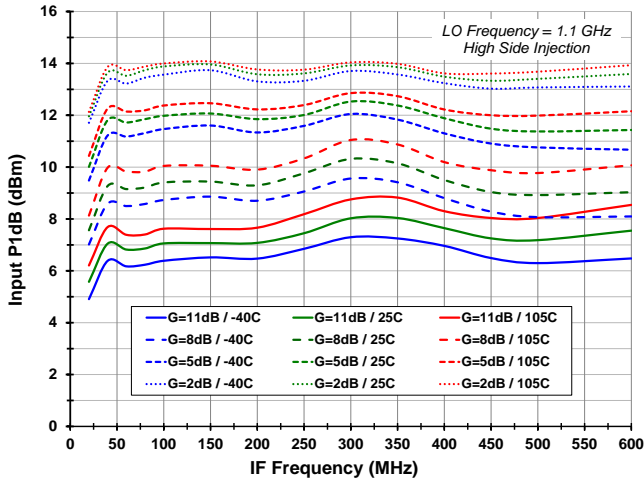

Figure 34. Input P1dB vs. Temperature and Gain Setting (LO=2.25GHz)

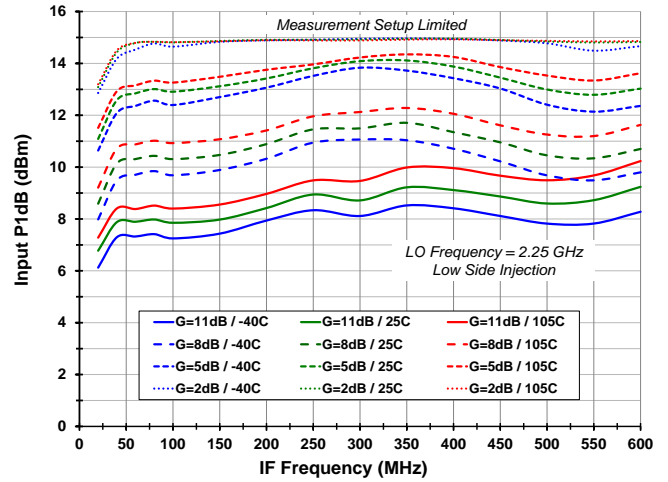

Figure 33. Input P1dB vs. Temperature and Gain Setting (LO=1.7GHz)

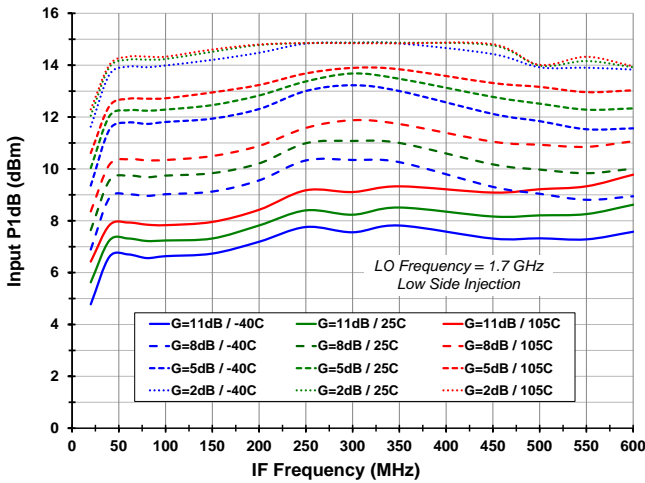
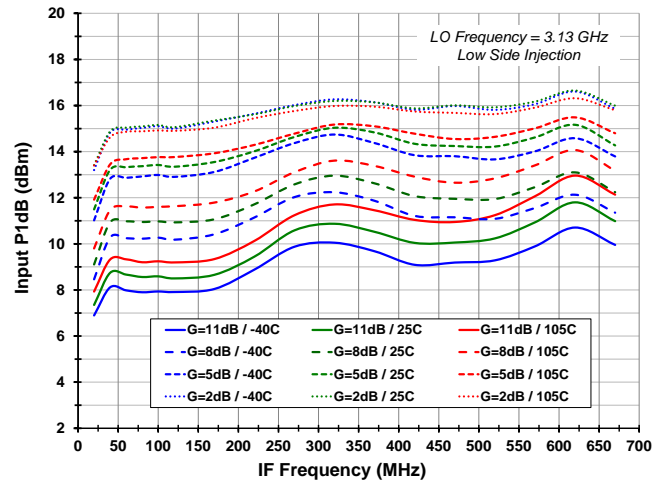

Figure 35. Input P1dB vs. Temperature and Gain Setting (LO=3.13GHz)



TOCs (-9-) Fixed LO=1.1GHz, 1.7GHz, 2.25GHz, 3.13GHz – Output IP2

Figure 36. Output IP2 vs. Temperature and Gain Setting (LO=1.1GHz)

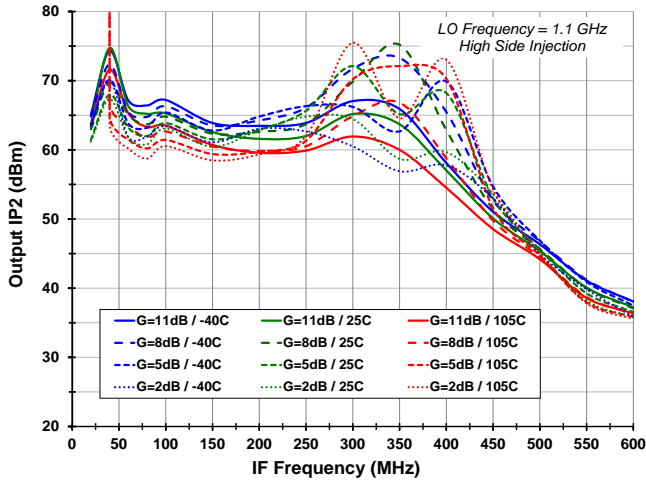

Figure 38. Output IP2 vs. Temperature and Gain Setting (LO=2.25GHz)

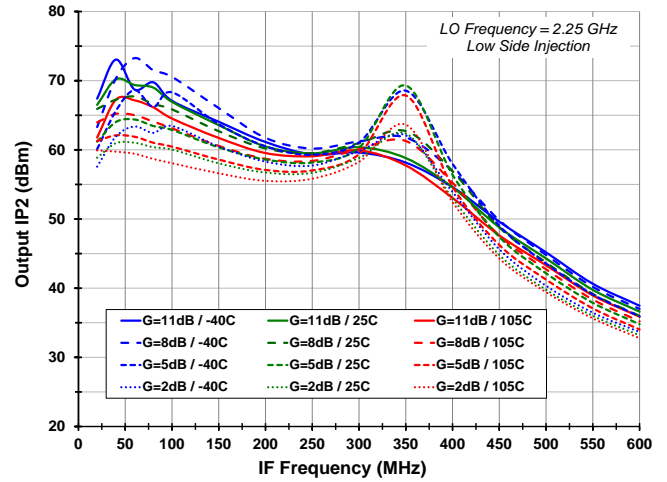

Figure 37. Output IP2 vs. Temperature and Gain Setting (LO=1.7GHz)

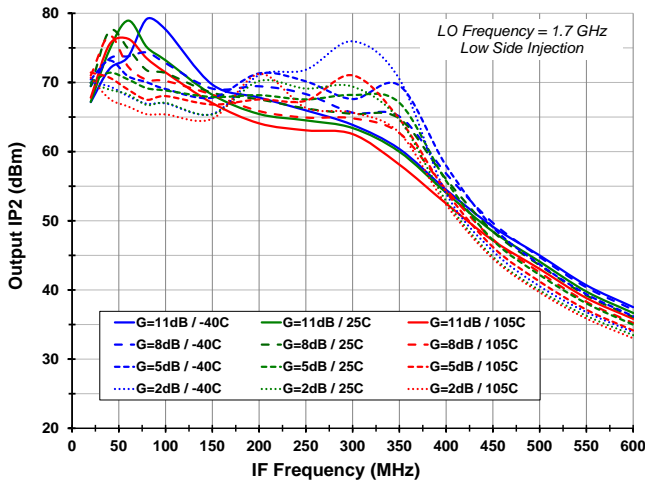
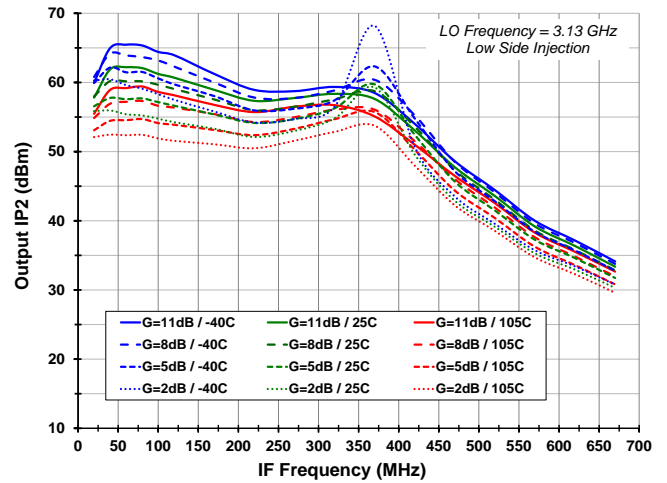

Figure 39. Output IP2 vs. Temperature and Gain Setting (LO=3.13GHz)



TOCs (-10-) Return Losses, Evaluation Kit Losses, STBY Settling Time

Figure 40. IF Port Return Loss vs. Gain Setting

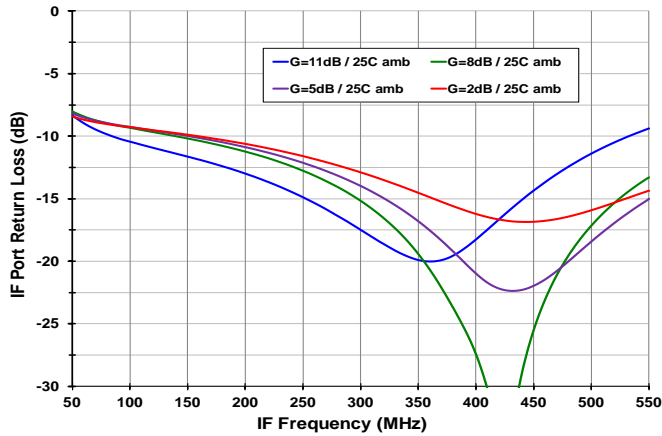

Figure 43. Evaluation Kit IF Transformer Loss vs. Temperature

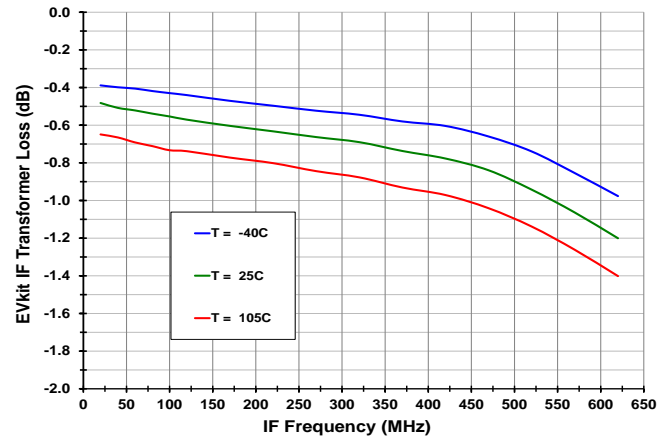

Figure 41. RF Port Return Loss vs. LO Frequency

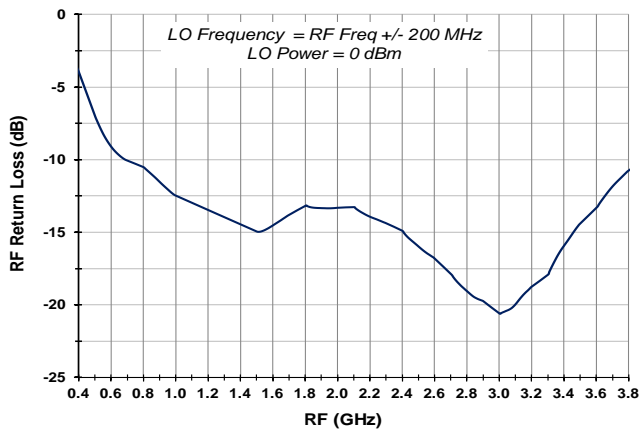

Figure 44. Evaluation Kit RF Trace Loss vs. Temperature

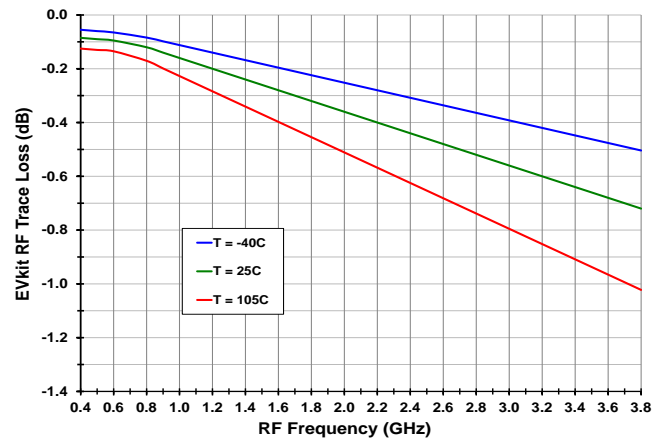

Figure 42. LO Port Return Loss vs. LO Power Level

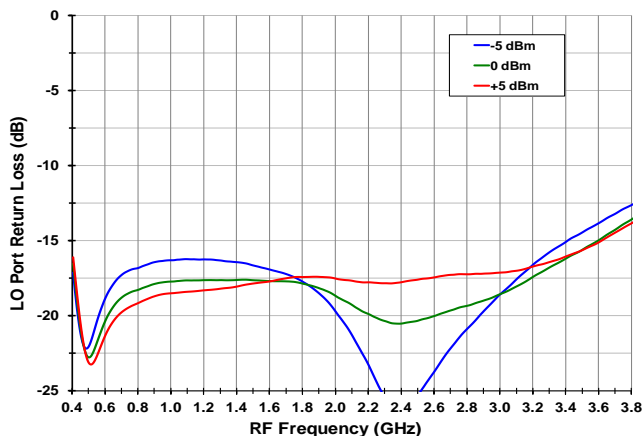
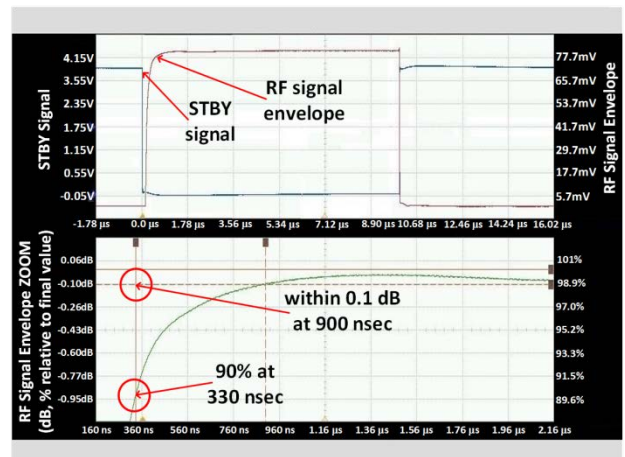

Figure 45. STBY Settling Time



TOCs (-11-) Gain Settling Time

Figure 46. Gain Settling Time for 11dB to 8dB Gain Setting

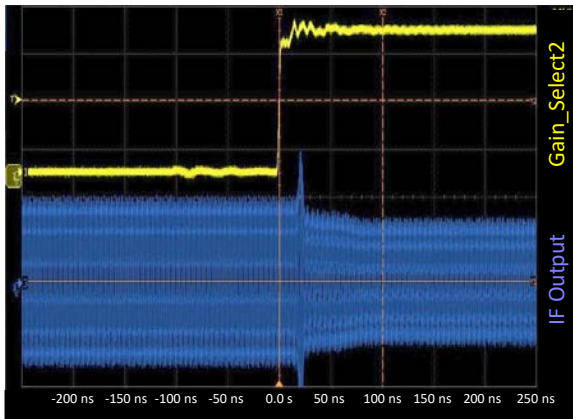

Figure 49. Gain Settling Time for 5dB to 8dB Gain Setting

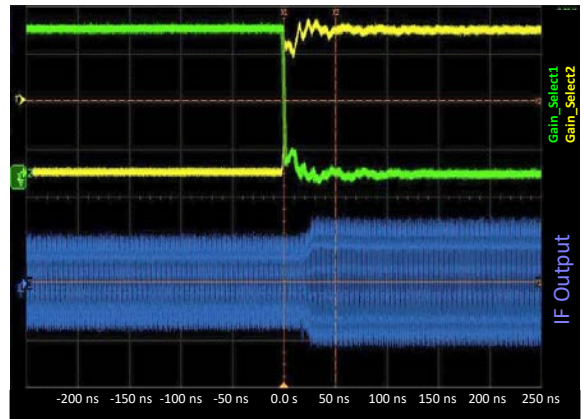

Figure 47. Gain Settling Time for 8dB to 11dB Gain Setting

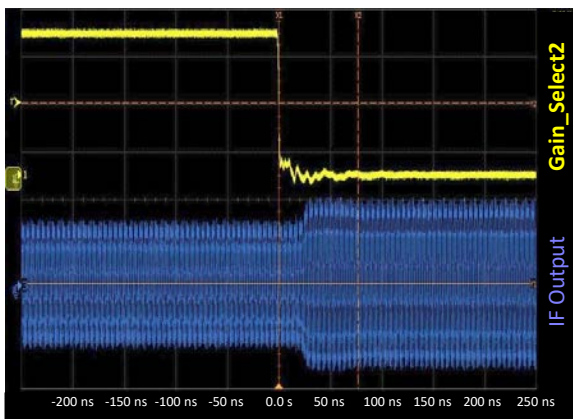

Figure 50. Gain Settling Time for 5dB to 2dB Gain Setting

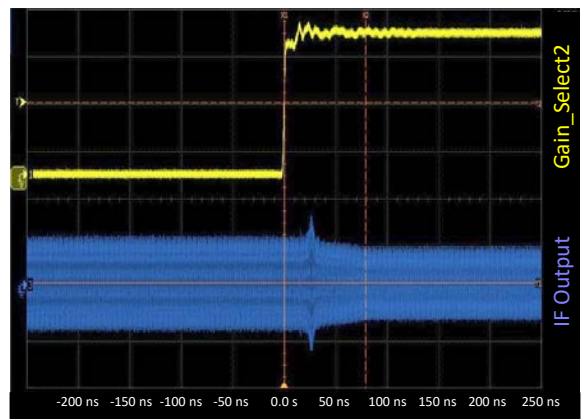

Figure 48. Gain Settling Time for 8dB to 5dB Gain Setting

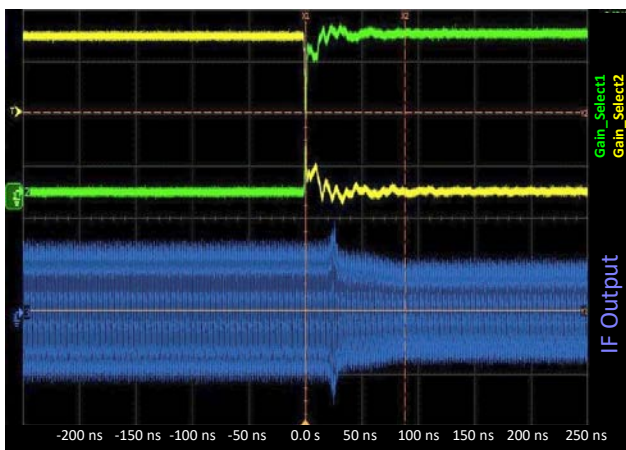
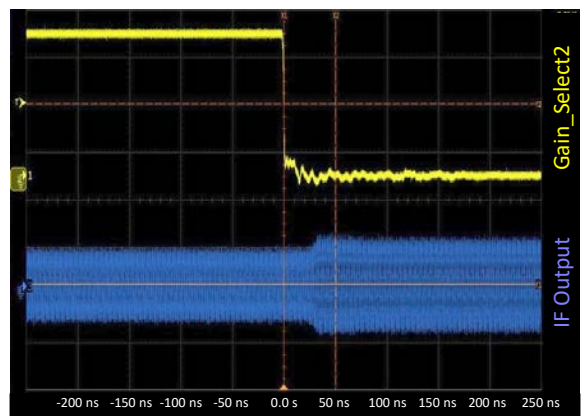
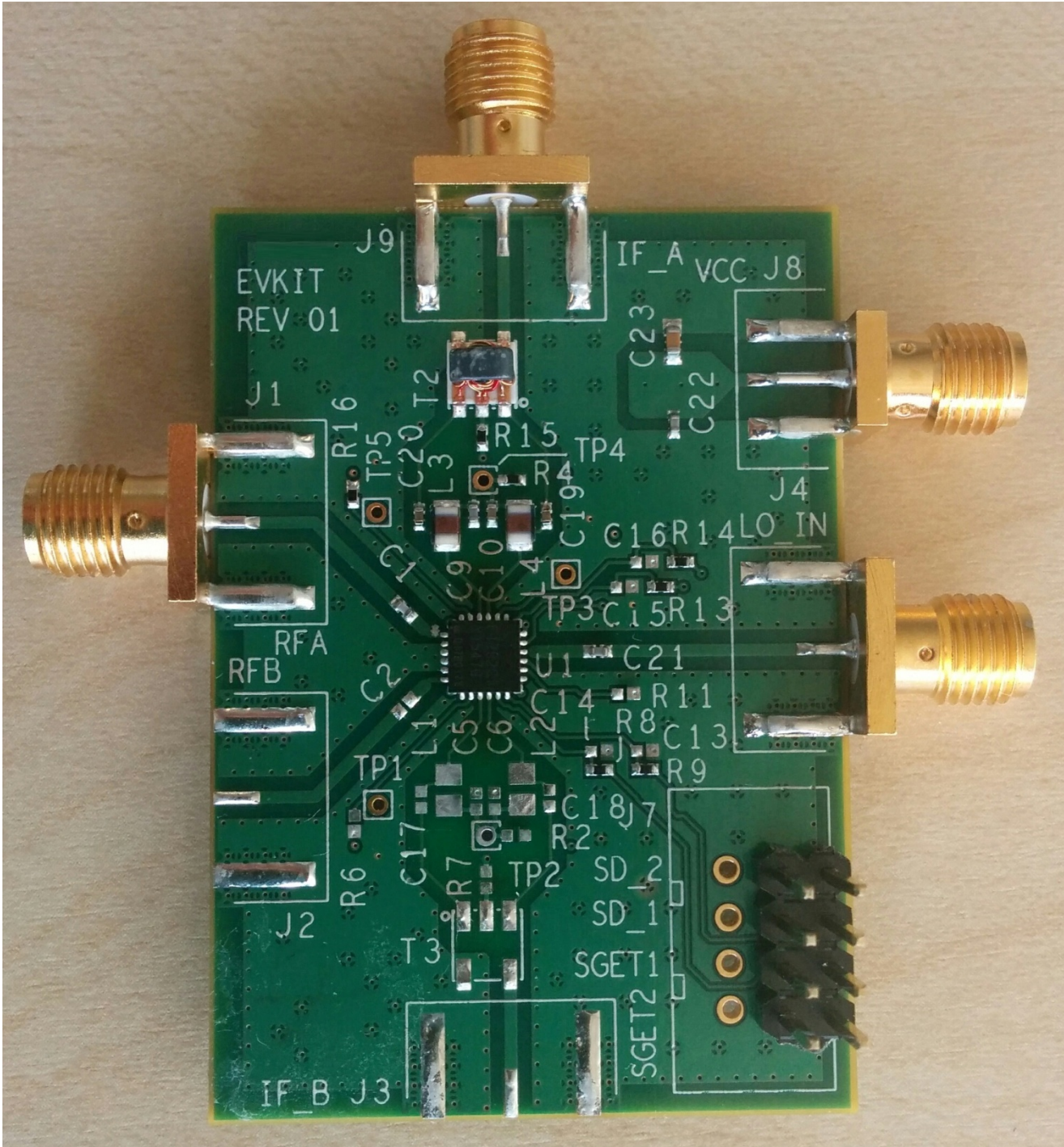

Figure 51. Gain Settling Time for 2dB to 5dB Gain Setting



Applications Information

EvKit Picture



EvKit / Applications Circuit

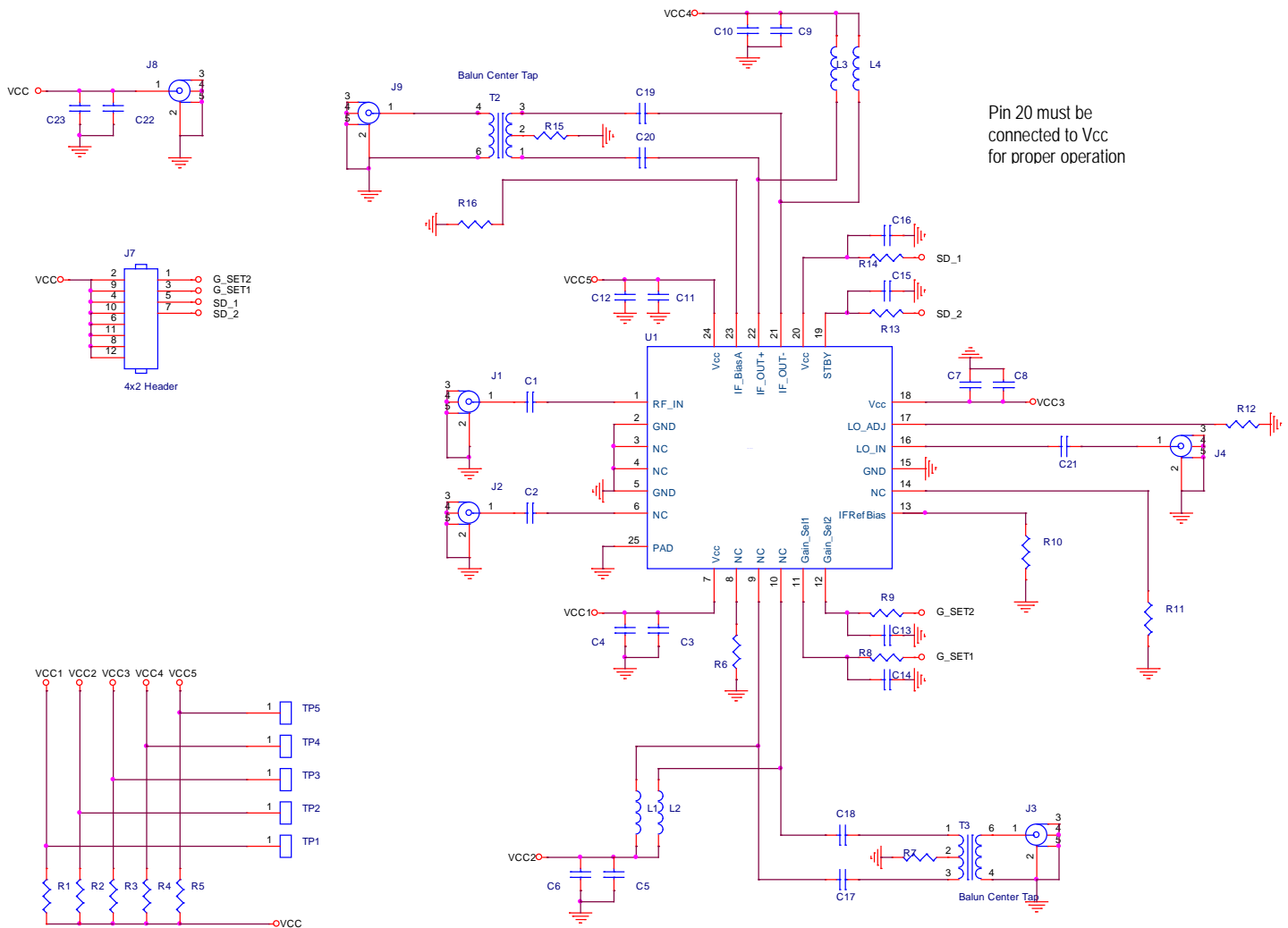

EvKit BOM

Part Reference	QTY	Description	Mfr. Part #	Mfr.
C3, C7, C9, C11, C22	6	1000pF ±5%, 50V, COG Ceramic Capacitor (0402)	GRM1555C1H102J	Murata
C4, C8, C10, C12, C19, C20, C23	10	10,000pF ±10%, 50V, X7R Ceramic Capacitor (0603)	GRM188R71H103KA01D	Murata
C21	1	1000pF ±5%, 50V, COG Ceramic Capacitor (0402)	GRM1555C1H102J	Murata
C1,	2	39pF ±5%. 5V, COG Ceramic Capacitor (0402)	GRM1555C1H390J	Murata
R1, R3-R5, R8, R9, R12, R13, R14, R15	13	0 Ohm, 1/10W, Resistor (0402)	ERJ-2GE0R00X	Panasonic
R16	2	390 Ohm ±1%, 1/10W, Resistor (0402)	ERJ-2RKF3900X	Panasonic
R10	1	1.74 kOhm ±1%, 1/10W, Resistor (0402)	ERJ-2RKF1741X	Panasonic
L3, L4	4	390nH ±5%, 0.29 A, Ceramic Chip Inductor (0805)	0805CS-391XJL	Coilcraft
T2	2	4:1 Center Tap Balun	TC4-6TG2+	Mini-Circuits
J7	1	CONN HEADER VERT DBL 4POS GOLD	67997-108HLF	FCI
J1, J4, J9	3	Edge Launch SMA Connector (Big)	142-0701-851	Emerson Johnson
J8	1	Edge Launch SMA Connector (Small)	142-0711-821	Emerson Johnson
U1	1	RF Dual Wideband Gain-Settable Downconverting Mixer 4x4 TQFN24	F1192NLGI	Renesas
	1	Printed Circuit Board	F1192 EVKIT REV 01	Renesas

Power Supplies

A common VCC power supply should be used for all pins requiring DC power. All supply pins should be bypassed with external capacitors to minimize noise and fast transients. Supply noise can degrade noise figure and fast transients can trigger ESD clamps and cause them to fail. Supply voltage change or transients should have a slew rate smaller than 1V/20µs. In addition, all control pins should remain at 0V (±0.3V) while the supply voltage ramps or while it returns to zero.

Control Pin Interface

If control signal integrity is a concern and clean signals cannot be guaranteed due to overshoot, undershoot, ringing, etc., provisions for an R-C circuit at the input of each control pin is recommended. This applies to pins 11, 12, and 19 as shown below.

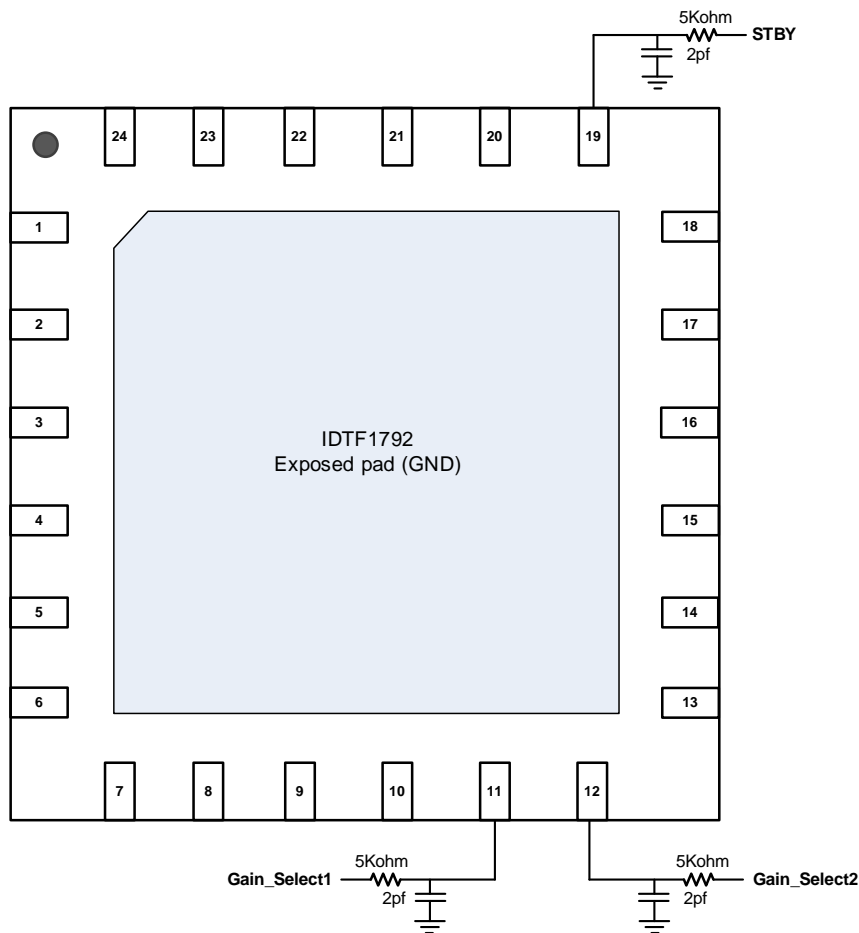

Gain Select

F1792 provides a gain select feature requiring 2 pins for logic control. The following table summarizes the required pin logic to achieve the desired gain setting. Internal pull down resistors are included requiring no control to set both channels to maximum gain.

Desired Power Gain (dB)	Gain Select1 (Pin 11) #	Gain Select2 (Pin 12)
11	0	0
8	0	1
5	1	0
2	1	1

Default Start-up

Upon start-up, the device gain will be whatever the gain select pins are set for as defined in the table above.

Package Outline Drawings

The package outline drawings are located at the end of this document and are accessible from the Renesas website (see Ordering Information for POD links). The package information is the most current data available and is subject to change without revision of this document.

Ordering Information

Orderable Part Number	Package	MSL Rating	Shipping Packaging	Temperature
F1792NLGI	4 x 4 x 0.9 mm 24-VFQFPN	MSL1	Tray	-40° to +85°C
F1792NLGI8	4 x 4 x 0.9 mm 24-VFQFPN	MSL1	Tape and Reel	-40° to +85°C

Marking Diagram

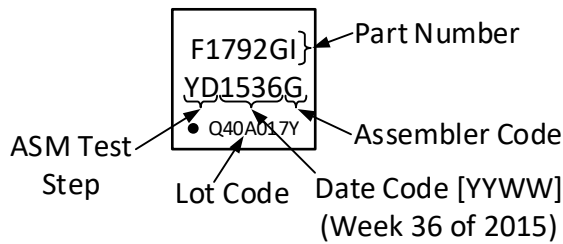

Revision History

Revision Date	Description of Change
February 9, 2022	Rebranded to Renesas.
December 13, 2019	<ul style="list-style-type: none"> Corrected a typo in logic current unit in Table 4. Updated the package outline drawings; however, no mechanical changes
April 5, 2016	First release (Rev O) of the F1792 datasheet.

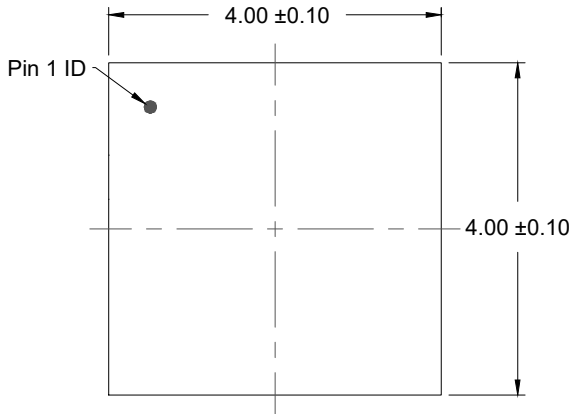

TOP VIEW

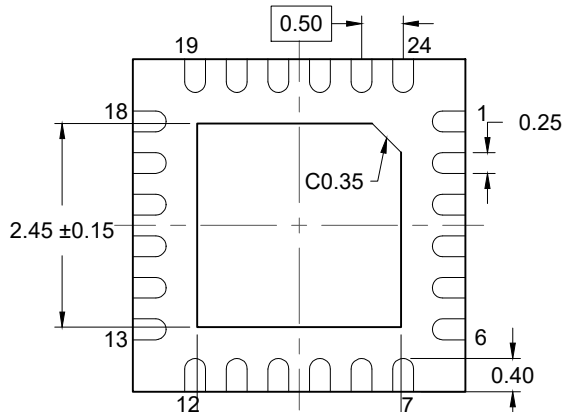

BOTTOM VIEW

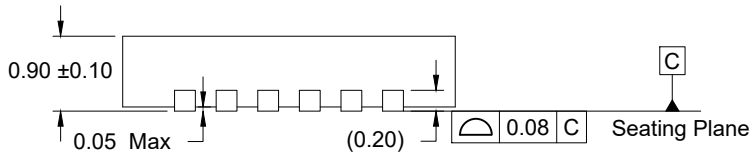

SIDE VIEW

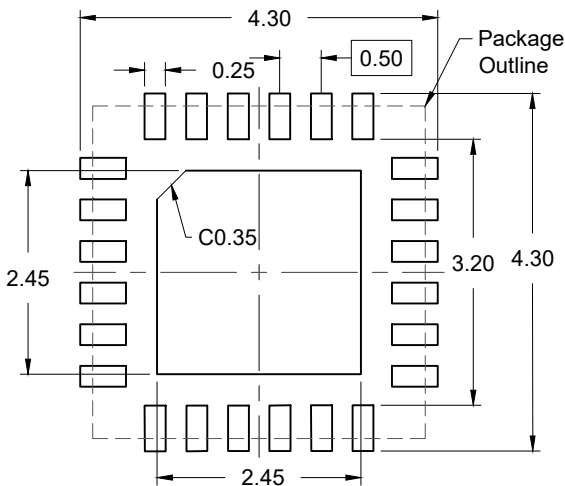

RECOMMENDED LAND PATTERN
 (PCB Top View, NSMD Design)

NOTES:

1. JEDEC compatible.
2. All dimensions are in mm and angles are in degrees.
3. Use ± 0.05 mm for the non-toleranced dimensions.
4. Numbers in () are for references only.

IMPORTANT NOTICE AND DISCLAIMER

RENESAS ELECTRONICS CORPORATION AND ITS SUBSIDIARIES (“RENESAS”) PROVIDES TECHNICAL SPECIFICATIONS AND RELIABILITY DATA (INCLUDING DATASHEETS), DESIGN RESOURCES (INCLUDING REFERENCE DESIGNS), APPLICATION OR OTHER DESIGN ADVICE, WEB TOOLS, SAFETY INFORMATION, AND OTHER RESOURCES “AS IS” AND WITH ALL FAULTS, AND DISCLAIMS ALL WARRANTIES, EXPRESS OR IMPLIED, INCLUDING, WITHOUT LIMITATION, ANY IMPLIED WARRANTIES OF MERCHANTABILITY, FITNESS FOR A PARTICULAR PURPOSE, OR NON-INFRINGEMENT OF THIRD PARTY INTELLECTUAL PROPERTY RIGHTS.

These resources are intended for developers skilled in the art designing with Renesas products. You are solely responsible for (1) selecting the appropriate products for your application, (2) designing, validating, and testing your application, and (3) ensuring your application meets applicable standards, and any other safety, security, or other requirements. These resources are subject to change without notice. Renesas grants you permission to use these resources only for development of an application that uses Renesas products. Other reproduction or use of these resources is strictly prohibited. No license is granted to any other Renesas intellectual property or to any third party intellectual property. Renesas disclaims responsibility for, and you will fully indemnify Renesas and its representatives against, any claims, damages, costs, losses, or liabilities arising out of your use of these resources. Renesas' products are provided only subject to Renesas' Terms and Conditions of Sale or other applicable terms agreed to in writing. No use of any Renesas resources expands or otherwise alters any applicable warranties or warranty disclaimers for these products.

(Disclaimer Rev.1.0 Mar 2020)

Corporate Headquarters

TOYOSU FORESIA, 3-2-24 Toyosu,
Koto-ku, Tokyo 135-0061, Japan
www.renesas.com

Contact Information

For further information on a product, technology, the most up-to-date version of a document, or your nearest sales office, please visit:
www.renesas.com/contact/

Trademarks

Renesas and the Renesas logo are trademarks of Renesas Electronics Corporation. All trademarks and registered trademarks are the property of their respective owners.