

# NGTB50N65FL2WAG

## IGBT - Field Stop II / 4 Lead

This Insulated Gate Bipolar Transistor (IGBT) features a robust and cost effective Field Stop II Trench construction, and provides superior performance in demanding switching applications, offering both low on state voltage and minimal switching loss. In addition, this new device is packaged in a TO-247-4L package that provides significant reduction in  $E_{on}$  Losses compared to standard TO-247-3L package. The IGBT is well suited for UPS and solar applications. Incorporated into the device is a soft and fast co-packaged free wheeling diode with a low forward voltage.

### Features

- Extremely Efficient Trench with Field Stop Technology
- $T_{Jmax} = 175^{\circ}C$
- Improved Gate Control Lowers Switching Losses
- Separate Emitter Drive Pin
- TO-247-4L for Minimal  $E_{on}$  Losses
- Optimized for High Speed Switching
- This is a Pb-Free Device

### Typical Applications

- Solar Inverters
- Uninterruptible Power Supplies (UPS)
- Neutral Point Clamp Topology

### ABSOLUTE MAXIMUM RATINGS

Rating	Symbol	Value	Unit
Collector-emitter voltage	$V_{CES}$	650	V
Collector current @ $T_c = 25^{\circ}C$ @ $T_c = 100^{\circ}C$	$I_c$	160 50	A
Diode Forward Current @ $T_c = 25^{\circ}C$ @ $T_c = 100^{\circ}C$	$I_F$	160 50	A
Diode Pulsed Current $T_{PULSE}$ Limited by $T_J$ Max	$I_{FM}$	160	A
Pulsed collector current, $T_{pulse}$ limited by $T_{Jmax}$	$I_{CM}$	160	A
Gate-emitter voltage	$V_{GE}$	$\pm 20$	V
Transient gate-emitter voltage ( $T_{PULSE} = 5 \mu s, D < 0.10$ )		$\pm 30$	
Power Dissipation @ $T_c = 25^{\circ}C$ @ $T_c = 100^{\circ}C$	$P_D$	417 208	W
Operating junction temperature range	$T_J$	-55 to +175	$^{\circ}C$
Storage temperature range	$T_{stg}$	-55 to +175	$^{\circ}C$
Lead temperature for soldering, 1/8" from case for 5 seconds	$T_{SLD}$	260	$^{\circ}C$

Stresses exceeding those listed in the Maximum Ratings table may damage the device. If any of these limits are exceeded, device functionality should not be assumed, damage may occur and reliability may be affected.



ON Semiconductor®

[www.onsemi.com](http://www.onsemi.com)

50 A, 650 V  
 $V_{CEsat} = 1.8 V$   
 $E_{on} = 0.48 mJ$

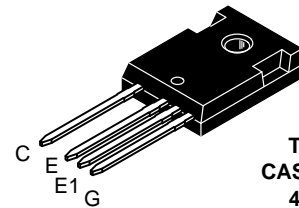
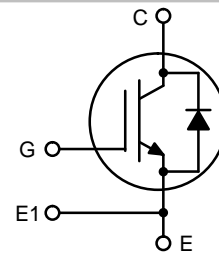

TO-247  
CASE 340AR  
4 LEAD

### MARKING DIAGRAM



50N65FL2 = Specific Device Code  
A = Assembly Location  
Y = Year  
WW = Work Week  
G = Pb-Free Package

### ORDERING INFORMATION

Device	Package	Shipping
NGTB50N65FL2WAG	TO-247 (Pb-Free)	30 Units / Rail

# NGTB50N65FL2WAG

## THEMAL CHARACTERISTICS

Rating	Symbol	Value	Unit
Thermal resistance junction-to-case, for IGBT	$R_{\theta JC}$	0.36	°C/W
Thermal resistance junction-to-case, for Diode	$R_{\theta JC}$	0.62	°C/W
Thermal resistance junction-to-ambient	$R_{\theta JA}$	40	°C/W

## ELECTRICAL CHARACTERISTICS ( $T_J = 25^\circ\text{C}$ unless otherwise specified)

Parameter	Test Conditions	Symbol	Min	Typ	Max	Unit
-----------	-----------------	--------	-----	-----	-----	------

### STATIC CHARACTERISTIC

Collector-emitter breakdown voltage, gate-emitter short-circuited	$V_{GE} = 0\text{ V}, I_C = 500\ \mu\text{A}$	$V_{(BR)CES}$	650	–	–	V
Collector-emitter saturation voltage	$V_{GE} = 15\text{ V}, I_C = 50\text{ A}$ $V_{GE} = 15\text{ V}, I_C = 50\text{ A}, T_J = 175^\circ\text{C}$	$V_{CEsat}$	–	1.80 2.17	2.00 –	V
Gate-emitter threshold voltage	$V_{GE} = V_{CE}, I_C = 350\ \mu\text{A}$	$V_{GE(th)}$	4.5	5.5	6.5	V
Collector-emitter cut-off current, gate-emitter short-circuited	$V_{GE} = 0\text{ V}, V_{CE} = 650\text{ V}$ $V_{GE} = 0\text{ V}, V_{CE} = 650\text{ V}, T_J = 175^\circ\text{C}$	$I_{CES}$	–	– 5.5	0.3 –	mA
Gate leakage current, collector-emitter short-circuited	$V_{GE} = 20\text{ V}, V_{CE} = 0\text{ V}$	$I_{GES}$	–	–	200	nA

### DYNAMIC CHARACTERISTIC

Input capacitance	$V_{CE} = 20\text{ V}, V_{GE} = 0\text{ V}, f = 1\text{ MHz}$	$C_{ies}$	–	5160	–	pF
Output capacitance		$C_{oes}$	–	244	–	
Reverse transfer capacitance		$C_{res}$	–	141	–	
Gate charge total	$V_{CE} = 480\text{ V}, I_C = 50\text{ A}, V_{GE} = 15\text{ V}$	$Q_g$	–	215	–	nC
Gate to emitter charge		$Q_{ge}$	–	48	–	
Gate to collector charge		$Q_{gc}$	–	116	–	

### SWITCHING CHARACTERISTIC, INDUCTIVE LOAD

Turn-on delay time	$T_J = 25^\circ\text{C}$ $V_{CC} = 400\text{ V}, I_C = 50\text{ A}$ $R_g = 10\ \Omega$ $V_{GE} = 15\text{ V}$	$t_{d(on)}$	–	23	–	ns	
Rise time		$t_r$	–	35	–		
Turn-off delay time		$t_{d(off)}$	–	123	–		
Fall time			$t_f$	–	54	–	mJ
Turn-on switching loss		$E_{on}$	–	0.42	–		
Turn-off switching loss		$E_{off}$	–	0.55	–		
Total switching loss		$E_{ts}$	–	0.97	–		
Turn-on delay time	$T_J = 175^\circ\text{C}$ $V_{CC} = 400\text{ V}, I_C = 50\text{ A}$ $R_g = 10\ \Omega$ $V_{GE} = 15\text{ V}$	$t_{d(on)}$	–	22	–	ns	
Rise time		$t_r$	–	38	–		
Turn-off delay time		$t_{d(off)}$	–	130	–		
Fall time			$t_f$	–	93	–	mJ
Turn-on switching loss		$E_{on}$	–	0.58	–		
Turn-off switching loss		$E_{off}$	–	0.92	–		
Total switching loss		$E_{ts}$	–	1.50	–		

### DIODE CHARACTERISTIC

Forward voltage	$V_{GE} = 0\text{ V}, I_F = 50\text{ A}$ $V_{GE} = 0\text{ V}, I_F = 50\text{ A}, T_J = 175^\circ\text{C}$	$V_F$	–	2.10 2.20	2.60 –	V
Reverse recovery time	$T_J = 25^\circ\text{C}$ $I_F = 50\text{ A}, V_R = 400\text{ V}$ $di_F/dt = 200\text{ A}/\mu\text{s}$	$t_{rr}$	–	94	–	ns
Reverse recovery charge		$Q_{rr}$	–	0.36	–	$\mu\text{C}$
Reverse recovery current		$I_{rrm}$	–	6.5	–	A
Reverse recovery time	$T_J = 175^\circ\text{C}$ $I_F = 50\text{ A}, V_R = 400\text{ V}$ $di_F/dt = 200\text{ A}/\mu\text{s}$	$t_{rr}$	–	170	–	ns
Reverse recovery charge		$Q_{rr}$	–	1.40	–	$\mu\text{C}$
Reverse recovery current		$I_{rrm}$	–	13	–	A

Product parametric performance is indicated in the Electrical Characteristics for the listed test conditions, unless otherwise noted. Product performance may not be indicated by the Electrical Characteristics if operated under different conditions.

# NGTB50N65FL2WAG

## TYPICAL CHARACTERISTICS

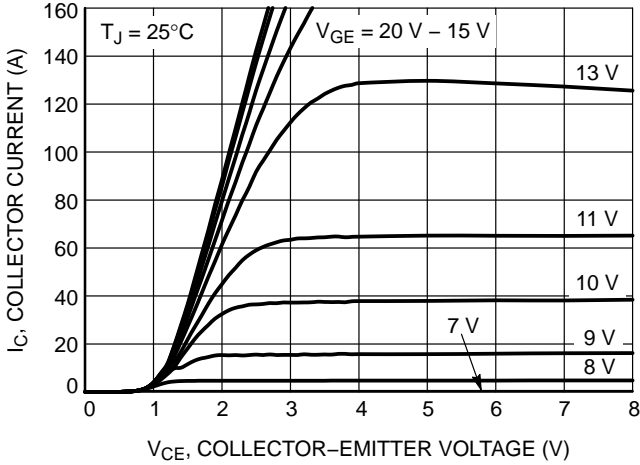

Figure 1. Output Characteristics

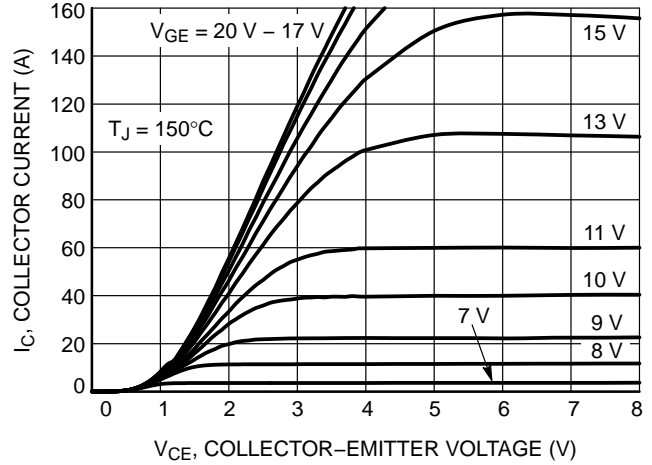

Figure 2. Output Characteristics

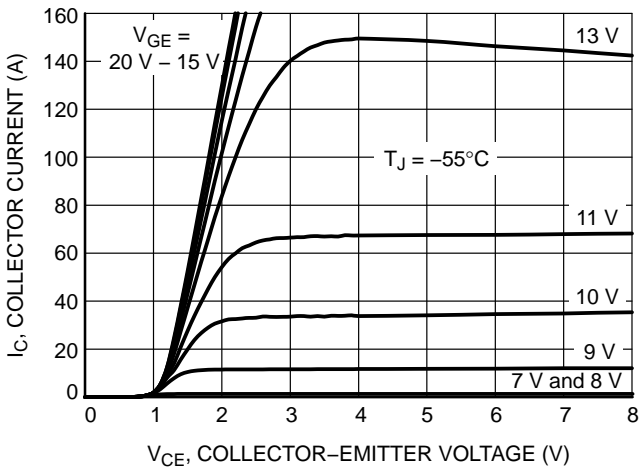

Figure 3. Output Characteristics

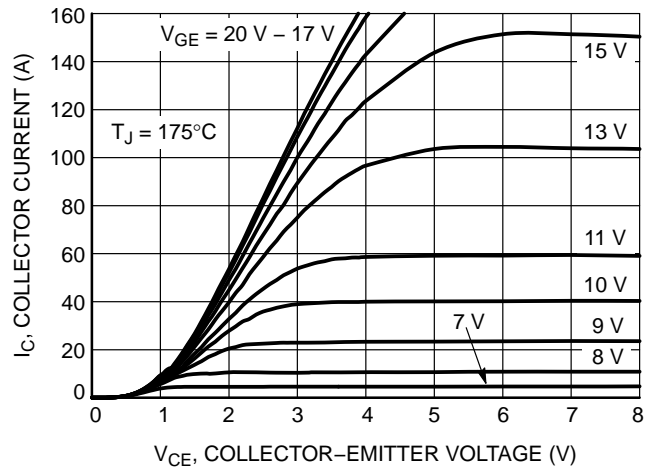

Figure 4. Output Characteristics

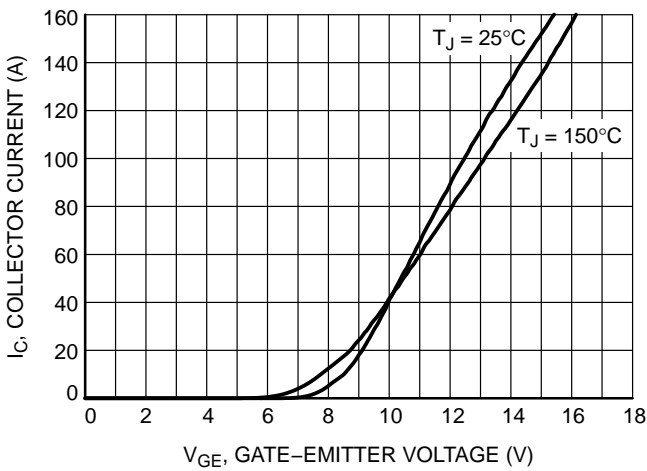

Figure 5. Typical Transfer Characteristics

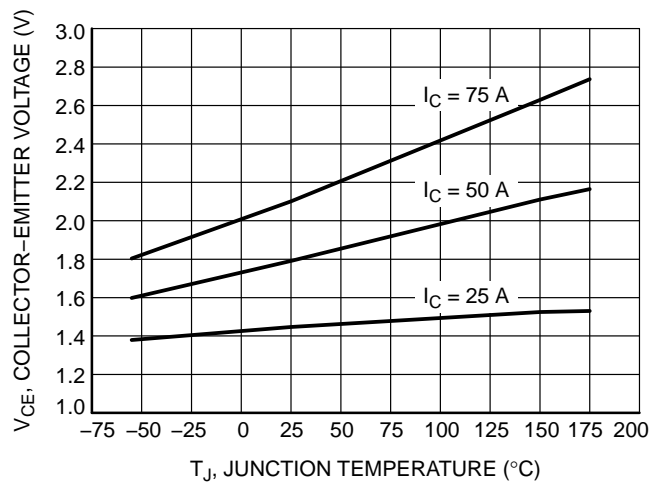

Figure 6.  $V_{CE(sat)}$  vs.  $T_J$

# NGTB50N65FL2WAG

## TYPICAL CHARACTERISTICS

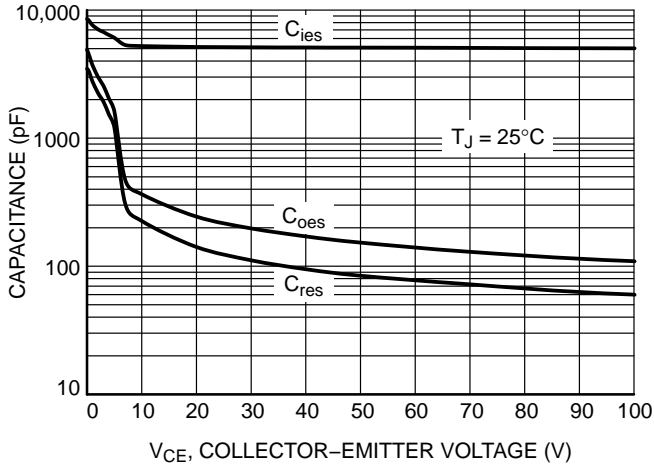

Figure 7. Typical Capacitance

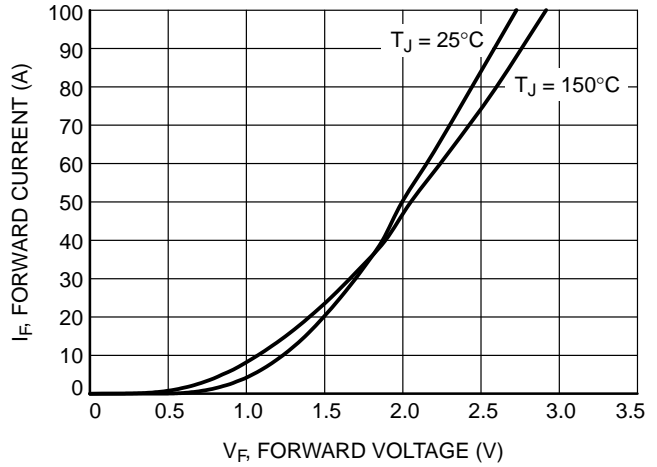

Figure 8. Diode Forward Characteristics

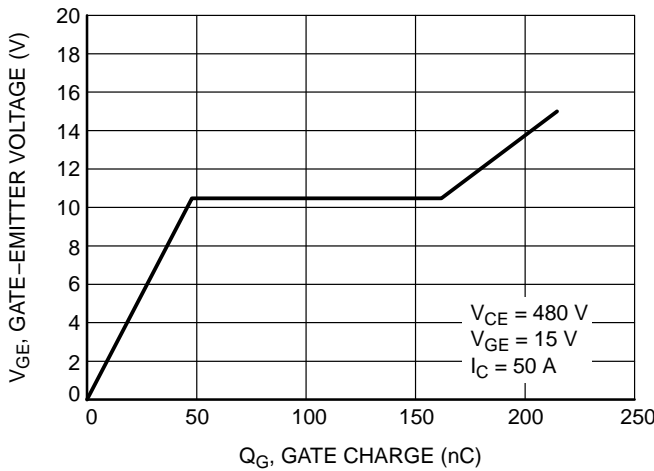

Figure 9. Typical Gate Charge

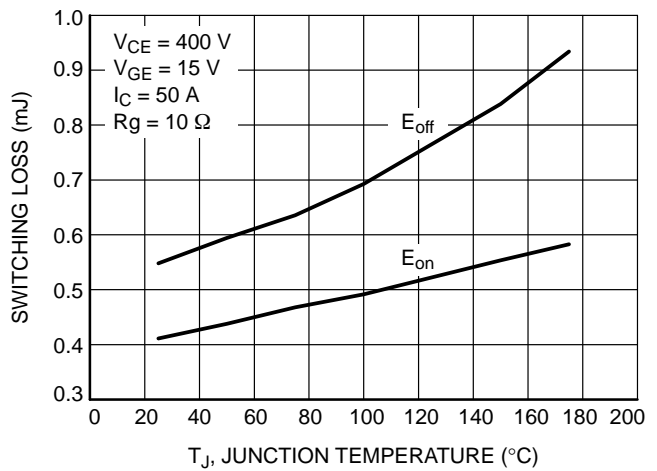

Figure 10. Switching Loss vs. Temperature

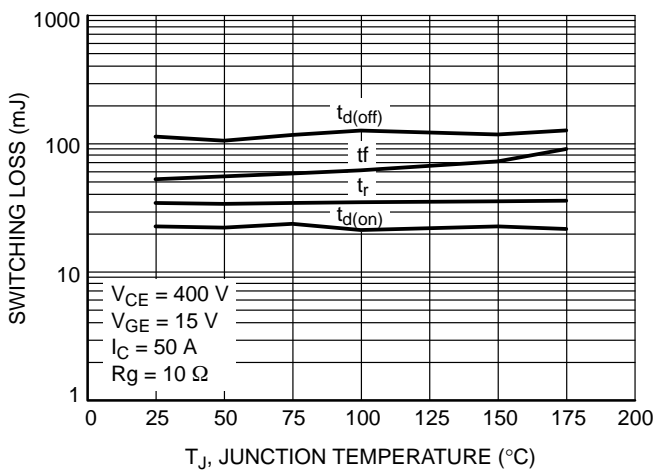

Figure 11. Switching Time vs. Temperature

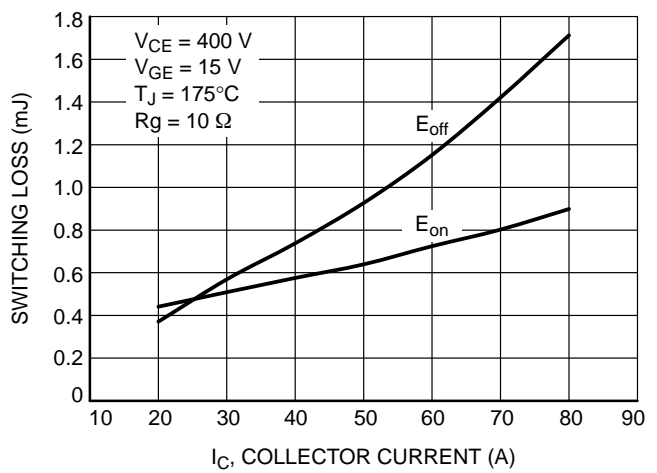

Figure 12. Switching Loss vs. IC

# NGTB50N65FL2WAG

## TYPICAL CHARACTERISTICS

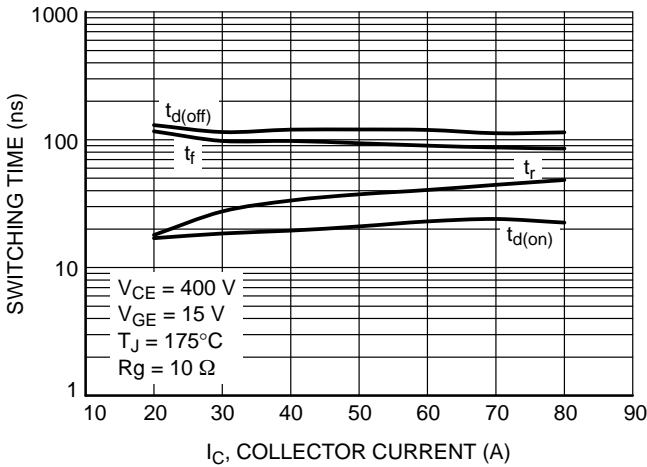

Figure 13. Switching Time vs.  $I_C$

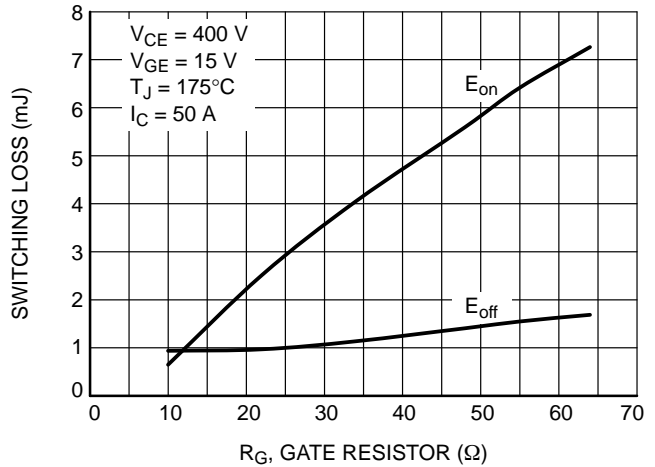

Figure 14. Switching Loss vs.  $R_G$

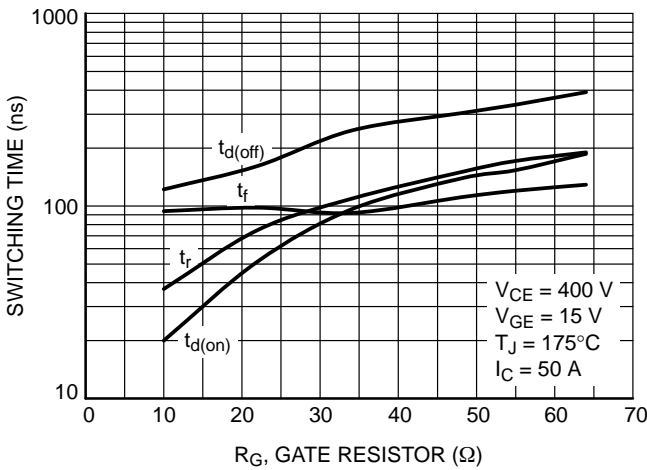

Figure 15. Switching Time vs.  $R_G$

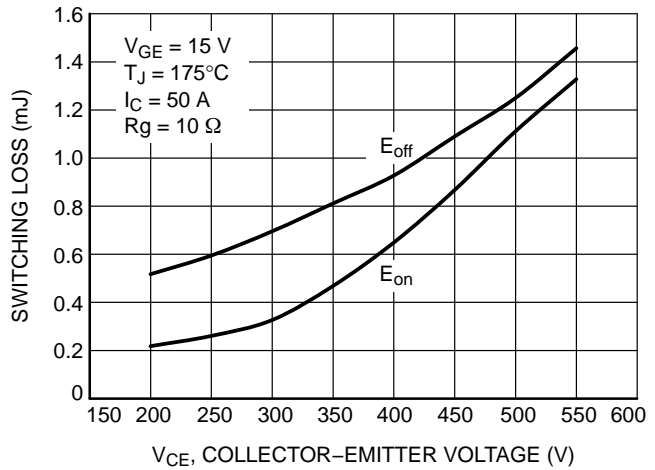

Figure 16. Switching Loss vs.  $V_{CE}$

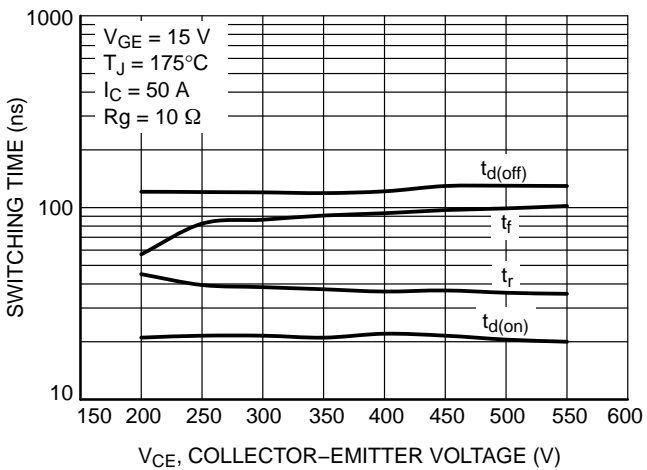

Figure 17. Switching Time vs.  $V_{CE}$

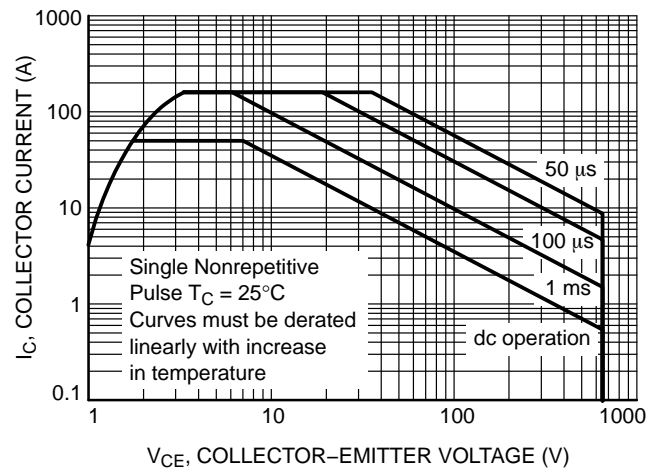

Figure 18. Safe Operating Area

# NGTB50N65FL2WAG

## TYPICAL CHARACTERISTICS

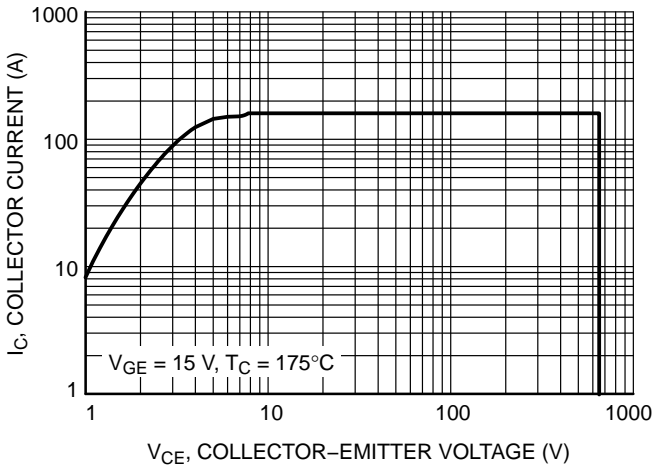

Figure 19. Reverse Bias Safe Operating Area

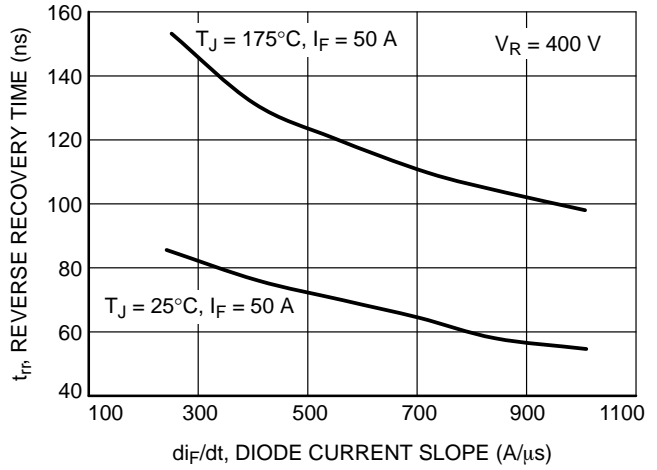

Figure 20.  $t_{rr}$  vs.  $di_F/dt$

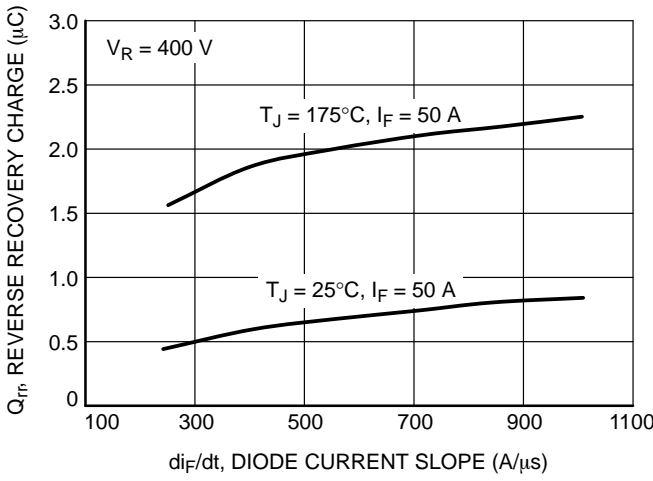

Figure 21.  $Q_{rr}$  vs.  $di_F/dt$

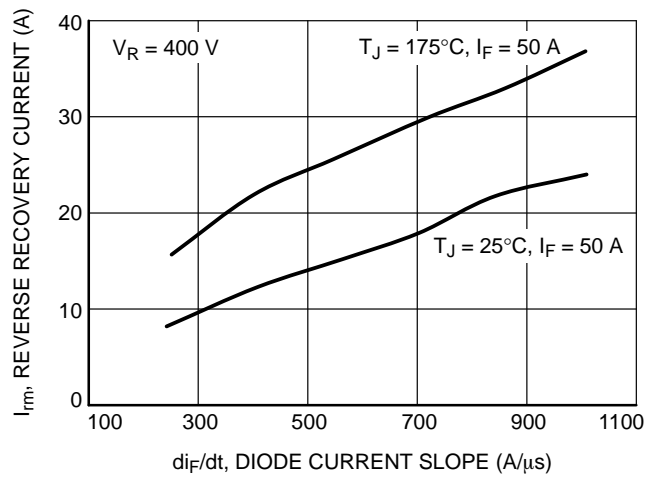

Figure 22.  $I_{rm}$  vs.  $di_F/dt$

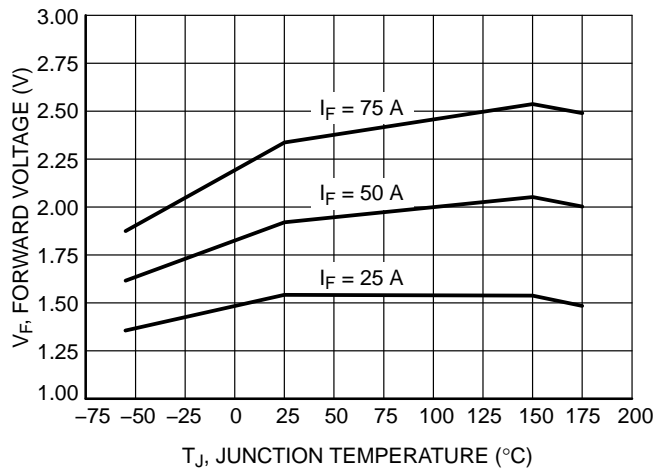

Figure 23.  $V_F$  vs.  $T_J$

# NGTB50N65FL2WAG

## TYPICAL CHARACTERISTICS

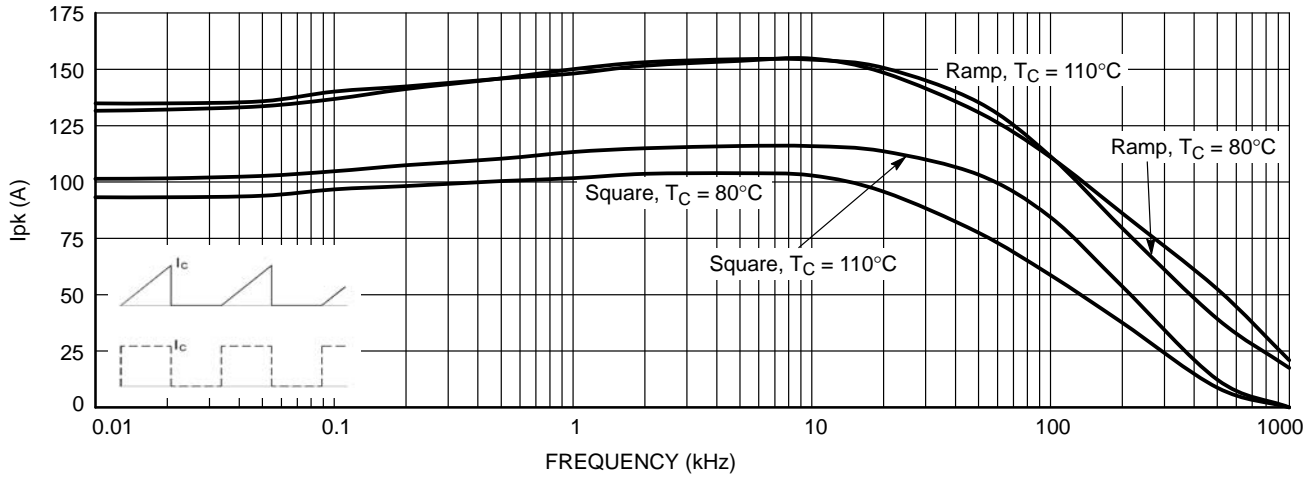

Figure 24. Collector Current vs. Switching Frequency

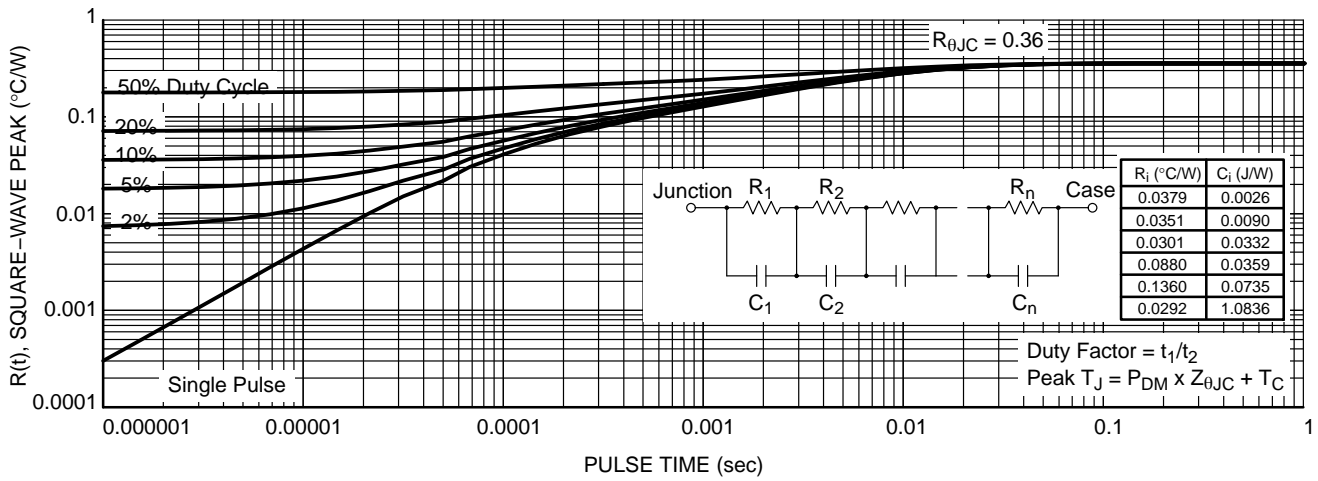

Figure 25. IGBT Transient Thermal Impedance

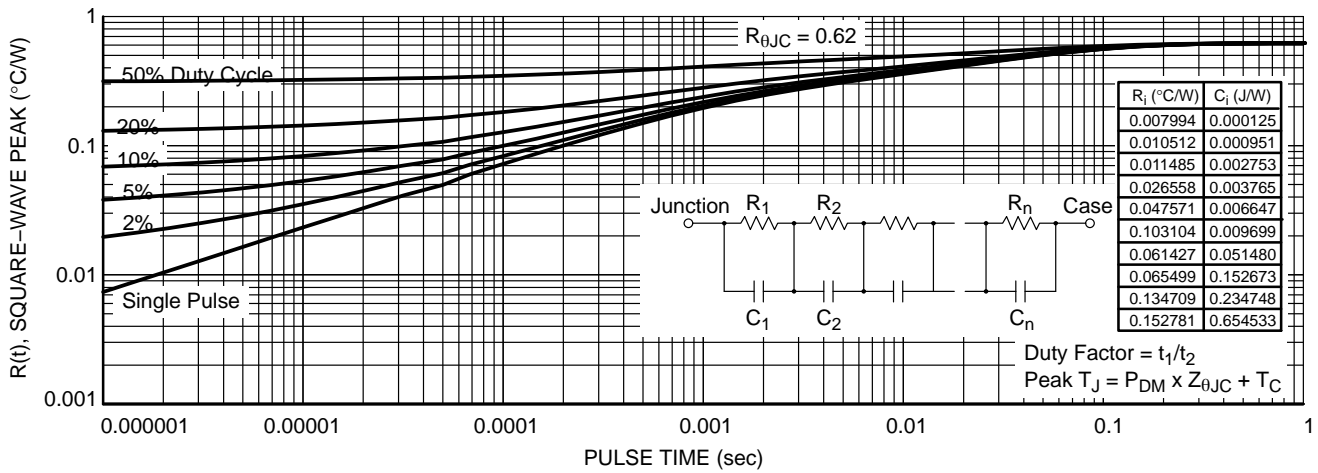

Figure 26. Diode Transient Thermal Impedance

# NGTB50N65FL2WAG

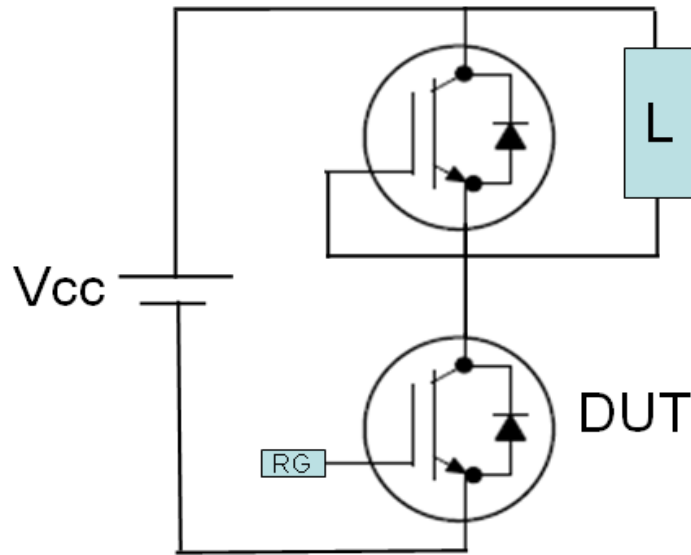

Figure 27. Test Circuit for Switching Characteristics

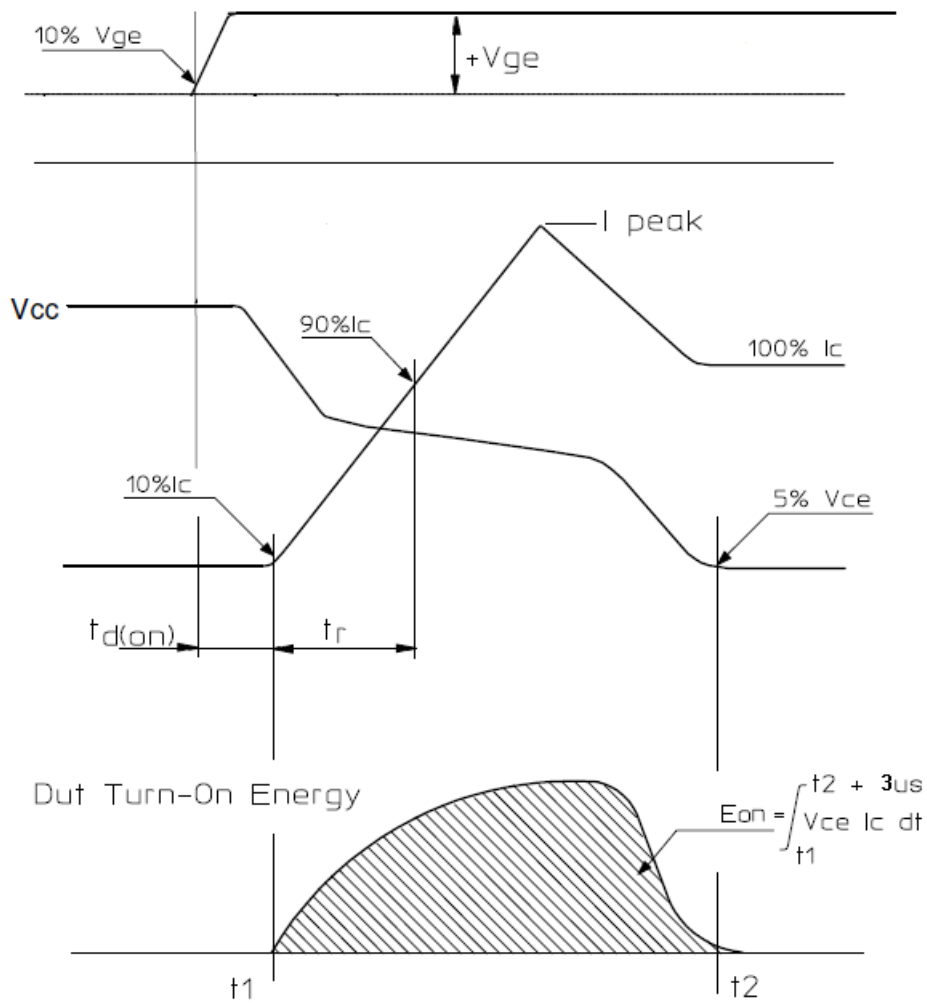

Figure 28. Definition of Turn On Waveform



# NGTB50N65FL2WAG



Figure 29. Definition of Turn Off Waveform

# MECHANICAL CASE OUTLINE PACKAGE DIMENSIONS

ON Semiconductor®



## TO-247 4-LEAD CASE 340AR ISSUE A

DATE 07 MAY 2020

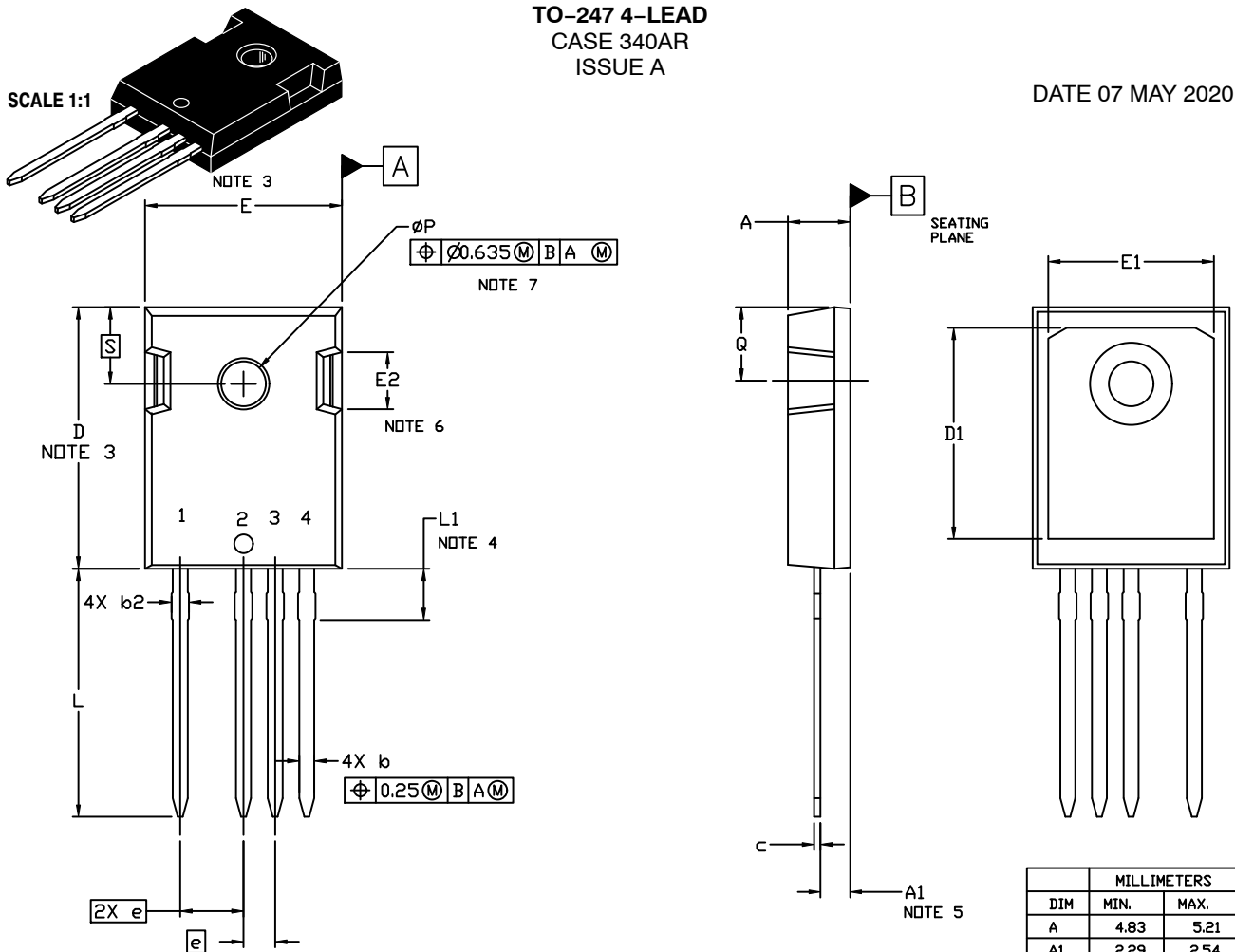

**NOTES:**

1. DIMENSIONING AND TOLERANCING PER ASME Y14.5M, 1994.
2. CONTROLLING DIMENSION: MILLIMETER
3. DIMENSIONS D AND E DO NOT INCLUDE MOLD FLASH. MOLD FLASH SHALL NOT EXCEED 0.13 PER SIDE. THESE DIMENSIONS ARE MEASURED AT THE OUTERMOST EXTREME OF THE PLASTIC BODY.
4. LEAD FINISH IS UNCONTROLLED IN THE REGION DEFINED BY L1.
5. DIMENSION A1 TO BE MEASURED IN THE REGION DEFINED BY L1.
6. NOTCHES ARE REQUIRED BUT THEIR SHAPE IS OPTIONAL.
7. DIAMETER P SHALL HAVE A MAXIMUM DRAFT ANGLE OF 3.5° TO THE TOP OF THE PART WITH A MAXIMUM DIAMETER OF 4.20.

**GENERIC MARKING DIAGRAM\***

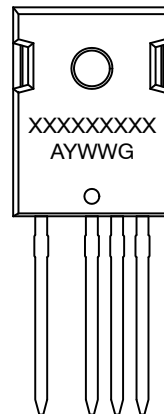

XXXXX = Specific Device Code  
A = Assembly Location  
Y = Year  
WW = Work Week  
G = Pb-Free Package

\*This information is generic. Please refer to device data sheet for actual part marking. Pb-Free indicator, "G" or microdot "•", may or may not be present. Some products may not follow the Generic Marking.

MILLIMETERS		
DIM	MIN.	MAX.
A	4.83	5.21
A1	2.29	2.54
b	1.10	1.30
b2	1.30	1.50
c	0.50	0.70
D	20.80	21.10
D1	16.25	17.65
E	15.75	16.13
E1	13.06	13.46
E2	4.32	4.83
e	2.54 BSC	
L	19.90	20.30
L1	4.00	4.40
P	3.50	3.70
Q	5.59	6.20
S	6.15 BSC	

<b>DOCUMENT NUMBER:</b>	<b>98AON97044F</b>	Electronic versions are uncontrolled except when accessed directly from the Document Repository. Printed versions are uncontrolled except when stamped "CONTROLLED COPY" in red.
<b>DESCRIPTION:</b>	<b>TO-247 4-LEAD</b>	<b>PAGE 1 OF 1</b>

ON Semiconductor and ON are trademarks of Semiconductor Components Industries, LLC dba ON Semiconductor or its subsidiaries in the United States and/or other countries. ON Semiconductor reserves the right to make changes without further notice to any products herein. ON Semiconductor makes no warranty, representation or guarantee regarding the suitability of its products for any particular purpose, nor does ON Semiconductor assume any liability arising out of the application or use of any product or circuit, and specifically disclaims any and all liability, including without limitation special, consequential or incidental damages. ON Semiconductor does not convey any license under its patent rights nor the rights of others.

**onsemi**, **Onsemi**, and other names, marks, and brands are registered and/or common law trademarks of Semiconductor Components Industries, LLC dba "**onsemi**" or its affiliates and/or subsidiaries in the United States and/or other countries. **onsemi** owns the rights to a number of patents, trademarks, copyrights, trade secrets, and other intellectual property. A listing of **onsemi**'s product/patent coverage may be accessed at [www.onsemi.com/site/pdf/Patent-Marking.pdf](http://www.onsemi.com/site/pdf/Patent-Marking.pdf). **onsemi** reserves the right to make changes at any time to any products or information herein, without notice. The information herein is provided "as-is" and **onsemi** makes no warranty, representation or guarantee regarding the accuracy of the information, product features, availability, functionality, or suitability of its products for any particular purpose, nor does **onsemi** assume any liability arising out of the application or use of any product or circuit, and specifically disclaims any and all liability, including without limitation special, consequential or incidental damages. Buyer is responsible for its products and applications using **onsemi** products, including compliance with all laws, regulations and safety requirements or standards, regardless of any support or applications information provided by **onsemi**. "Typical" parameters which may be provided in **onsemi** data sheets and/or specifications can and do vary in different applications and actual performance may vary over time. All operating parameters, including "Typicals" must be validated for each customer application by customer's technical experts. **onsemi** does not convey any license under any of its intellectual property rights nor the rights of others. **onsemi** products are not designed, intended, or authorized for use as a critical component in life support systems or any FDA Class 3 medical devices or medical devices with a same or similar classification in a foreign jurisdiction or any devices intended for implantation in the human body. Should Buyer purchase or use **onsemi** products for any such unintended or unauthorized application, Buyer shall indemnify and hold **onsemi** and its officers, employees, subsidiaries, affiliates, and distributors harmless against all claims, costs, damages, and expenses, and reasonable attorney fees arising out of, directly or indirectly, any claim of personal injury or death associated with such unintended or unauthorized use, even if such claim alleges that **onsemi** was negligent regarding the design or manufacture of the part. **onsemi** is an Equal Opportunity/Affirmative Action Employer. This literature is subject to all applicable copyright laws and is not for resale in any manner.

## PUBLICATION ORDERING INFORMATION

### LITERATURE FULFILLMENT:

Email Requests to: [orderlit@onsemi.com](mailto:orderlit@onsemi.com)

**onsemi Website:** [www.onsemi.com](http://www.onsemi.com)

### TECHNICAL SUPPORT

**North American Technical Support:**  
Voice Mail: 1 800-282-9855 Toll Free USA/Canada  
Phone: 011 421 33 790 2910

**Europe, Middle East and Africa Technical Support:**

Phone: 00421 33 790 2910

For additional information, please contact your local Sales Representative